



Operation Manual

PRODUCT NAME

MIST SEPARATOR

MODEL/ Series

AFM20- (F, N) 01 ~ (F, N) 02 (B, C) (-2, 6, C, J, R, Z)
AFM30- (F, N) 02 ~ (F, N) 03 (B, C, D) (-2, 6, 8, J, R, W, Z)
AFM40- (F, N) 02 ~ (F, N) 04 (B, C, D) (-2, 6, 8, J, R, W, Z)
AFM40- (F, N) 06 (B, C, D) (-2, 6, 8, J, R, W, Z)

SMC Corporation

Contents

	PAGE
1. PRECAUTIONS FOR SAFETY	1~4
2. APPLICATION	5
3. SPECIFICATIONS	5
4. HOW TO ORDER	5
5. MAXIMUM APPLICABLE FLOW RATE	6
6. TROUBLE SHOOTING	6
7. CONSTRUCTION / PARTS LIST	7
8. SPECIFICATIONS OF BOWL ASSEMBLY	8~10
9. HOW TO REPLACEMENT	11
10. DISASSEMBLY DRAWING	12~13
11. DIMENSIONS	14



MIST SEPARATOR

Safety Instructions

These safety instructions are intended to prevent hazardous situations and/or equipment damage. These instructions indicate the level of potential hazard with the labels of "Caution," "Warning" or "Danger." They are all important notes for safety and must be followed in addition to International Standards (ISO/IEC), Japan Industrial Standards (JIS)*1) and other safety regulations*2).

- *1) ISO 4414: Pneumatic fluid power -- General rules relating to systems
ISO 4413: Hydraulic fluid power -- General rules relating to systems
IEC 60204-1: Safety of machinery -- Electrical equipment of machines (Part 1: General requirements)
ISO 10218-1992: Manipulating industrial robots -- Safety
JIS B 8370: General rules for pneumatic equipment.
JIS B 8361: General rules for hydraulic equipment.
JIS B 9960-1: Safety of machinery -- Electrical equipment for machines. (Part 1: General requirements)
JIS B 8433-1993: Manipulating industrial robots - Safety. etc.

*2) Labor Safety and Sanitation Law, etc.



Caution Operator error could result in injury or equipment damage.



Warning Operator error could result in serious injury or loss of life.



Danger In extreme conditions, there is a possibility of serious injury or loss of life.

Warning

1. The compatibility of the product is the responsibility of the person who designs the equipment or decides its specifications.

Since the product specified here is used under various operating conditions, its compatibility with specific equipment must be decided by the person who designs the equipment or decides its specifications based on necessary analysis and test results.

The expected performance and safety assurance of the equipment will be the responsibility of the person who has determined its compatibility with the product.

This person should also continuously review all specifications of the product referring to its latest catalog information, with a view to giving due consideration to any possibility of equipment failure when configuring the equipment.

2. Only personnel with appropriate training should operate machinery and equipment.

The product specified here may become unsafe if handled incorrectly.

The assembly, operation and maintenance of machines or equipment including our products must be performed by an operator who is appropriately trained and experienced.

3. Do not service or attempt to remove product and machinery/equipment until safety is confirmed.

The inspection and maintenance of machinery/equipment should only be performed after measures to prevent falling or runaway of the driven objects have been confirmed.

When the product is to be removed, confirm that the safety measures as mentioned above are implemented and the power from any appropriate source is cut, and read and understand the specific product precautions of all relevant products carefully.

Before machinery/equipment is restarted, take measures to prevent unexpected operation and malfunction.

4. Contact SMC beforehand and take special consideration of safety measures if the product is to be used in any of the following conditions.

1) Conditions and environments outside of the given specifications, or use outdoors or in a place exposed to direct sunlight.

2) Installation on equipment in conjunction with atomic energy, railways, air navigation, space, shipping, vehicles, military, medical treatment, combustion and recreation, or equipment in contact with food and beverages, emergency stop circuits, clutch and brake circuits in press applications, safety equipment or other applications unsuitable for the standard specifications described in the product catalog.

3) An application which could have negative effects on people, property, or animals requiring special safety analysis.

4) Use in an interlock circuit, which requires the provision of double interlock for possible failure by using a mechanical protective function, and periodical checks to confirm proper operation.



MIST SEPARATOR

Safety Instructions

Caution

The product is provided for use in manufacturing industries.

The product herein described is basically provided for peaceful use in manufacturing industries.

If considering using the product in other industries, consult SMC beforehand and exchange specifications or a contract if necessary.

If anything is unclear, contact your nearest sales branch.

Limited warranty and Disclaimer/Compliance Requirements

The product used is subject to the following "Limited warranty and Disclaimer" and "Compliance Requirements".

Read and accept them before using the product.

Limited warranty and Disclaimer

The warranty period of the product is 1 year in service or 1.5 years after the product is delivered. Also, the product may have specified durability, running distance or replacement parts. Please consult your nearest sales branch.

For any failure or damage reported within the warranty period which is clearly our responsibility, a replacement product or necessary parts will be provided.

This limited warranty applies only to our product independently, and not to any other damage incurred due to the failure of the product.

Prior to using SMC products, please read and understand the warranty terms and disclaimers noted in the specified catalog for the particular products.

Compliance Requirements

When the product is exported, strictly follow the laws required by the Ministry of Economy, Trade and Industry (Foreign Exchange and Foreign Trade Control Law).

Precautions for design

WARNING

- ① Consult SMC if no leakage is allowed due to the environment, or operating fluid is not air
- ② External parts including the bowl are made of resin. Organic solvents including synthetic fluid, chemicals including acetone, alcohol, ethylene chloride, sulphuric acid, nitrate, hydrochloric acid, cutting oil, kerosene, gasoline, lock material of screw are harmful. Don't use the regulator where containing those.
- ③ Avoid the application where charge and discharge of pressure to standard bowl is switched frequently. The bowl may be broken. For this kind of application, the metal bowl is recommended.
- ④ Protect from ultra violet ray and radiation heat by shield.

CAUTION

- ① Design the system so that the mist separator is installed in a pulsation-free location. The difference between internal and external pressure inside the element should be kept within 0.1MPa, as exceeding this value could cause damage.
- ② AD27 with auto drain may leak the drain pooled there during exhaust of pressure. (This leakage is allowed in their constructions and not failure.) Be sure to connect piping for drain.

Selection

WARNING

- ① Mineral grease used for internal packing may leak to the outlet side. Please contact SMC if this is a problem.
- ② N.O type auto drain should be used under the following requirements to avoid operating failure. Output of compressor: 0.75kW or more.
Discharged flow rate: 100L/min (ANR) or more.
If multiple auto drains are used, confirm used compressor has capacity over the result of multiplying the above capacity and the number of used auto drains.
[For example, in case of two auto drain, the compressor need the capacity over 1.5kW [200L/min (ANR)].]
- ③ N.C. type auto drain should be used under the following requirements to avoid operating failure.
Operating pressure: 0.1MPa at min. for AD27, 0.15MPa at min. for AD37 and 47.

CAUTION

- ① Do not allow air flow that exceeds the rated flow.
If the air flow is allowed outlet side the range of the rated flow even momentarily, drainage and lubricant may splash at the outlet side or cause damage to the component.
- ② Do not use in a low pressure application (such as a blower). F.R.L. unit has its own minimum operating pressure and is designed specifically to function with compressed air. If used below the minimum operating pressure, a loss of performance and malfunction can occur.

Installation

CAUTION

- ① Don't drop nor apply impact during transportation or installation. It causes damage of the product and malfunction.
- ② Don't install where highly humid or temperature is high. It causes damage of the product and malfunction.
- ③ Connect the mist separator ensuring the direction of "IN" and "OUT" for air direction or an arrow. Wrong connection lead to cause malfunction.
- ④ Install vertically so that outlet of drain would turned downward. Use with the outlet of drain turned lateral or upward causes malfunction.
- ⑤ Make a space to provide easy access at the bottom when replacing element or draining dimensions. For dimensions of the space, refer to Outside

Piping

WARNING

- ① Flash or clean piping before piping to eliminate swarf, cutting oil, solid foreign material. Remaining of these lead to cause malfunction.
- ② When screw in piping or fitting, avoid entering of chips and sealing materials from piping screws into the inside of equipment. Or malfunction is led to occur. When use sealing tapes, leave 1.5~2 threads of a screw and starts taping.

Piping

- ③ Hold the female screw side and screw in piping with recommended tightening torque. Insufficient tightening torque lead to cause loose piping or sealing failure. Excessive torque may lead to cause screw breakage. Tightening without holding female screw side applies 'excessive force to the piping bracket which lead to cause breakage.

Recommended torque	unit: N·m				
Screw	1/8	1/4	3/8	1/2	3/4
Torque	7~9	12~14	22~24	28~30	28~30

- ④ Don't apply any torsional moment, or bending moment except the weight of the regulator itself. External pipings need its support separately. Hard piping like steel tube is susceptible to excessive moment load or vibration. Insert the flexible tube to cancel the influence
- ⑤ Drain guide is not equipped with valve function. Be sure to connect piping for drain. No piping for drain allows the drain and compressed air to exhaust freely. Also, the piping should be performed with drain guide held by spanner to prevent breakage of bowl.
- ⑥ The piping for drain from auto drain should be connected under the following requirements to avoid operating failure.
 AD27: I.D. ϕ 2.5 (ϕ 3/32") at min., Length 5m (200") at max.
 AD37, 47(N): I.D. ϕ 4 (ϕ 3/16") at min., Length 5m (200") at max.
 AD38, 48(N): I.D. ϕ 6.5 (ϕ 1/4") at min., Length 5m (200") at max.

Air Source

WARNING

- ① Use clean air. Compressed air containing chemicals, organic solvent, synthetic oil or corrosive gas may lead to cause breakage of parts or malfunction.
- ② Air containing much drain lead to cause malfunction. Install the air drier or the after-cooler before the mist separator.

CAUTION

- ① Do not install on the inlet side of the dryer as this can cause premature clogging of the element.
- ② Install an air filter (Series AF) as a preliminary filter on the inlet side of the mist separator to prevent premature clogging.

Maintenance

WARNING

- ① Maintenance or check should be done by following the procedure in the operation manual. Incorrect handling of the product may cause breakage or malfunction of the equipment or device.
- ② Perform periodical check to find crack, flaw or other deterioration on resin bowl. If any of them is seen, as malfunction is caused, replace with new bowl or metal bowl.
- ③ Check the dirt of resin bowl periodically. If any dirt is seen, replace with new bowl. And if removing off the dirt by washing instead of replacement, never use washing material other than neutral detergent. Otherwise, the bowl is damaged.
- ④ Open and close drain cock manually. Open and close by a too may damage the drain cock.
- ⑤ Replace the element before 2 years passed since purchase or pressure drop from initial outlet pressure reaches 0.1MPa. Or the element is broken.

CAUTION

- ① Drain the bowl by opening drain cock before the drain level in the bowl reaches element
- ② Check the element periodically and replace it with new one if necessary.
If it is found that secondary pressure lowers or the flow is restricted, check the condition of element.
- ③ The manual exhaust for emergency case can be performed by counterclockwise rotation of the handle in AD27. (○←direction)
For AD37, 38, 47 and 48, rotate the drain cock counterclockwise in that case.(○←direction)

2. APPLICATION

This instrument aims at, eliminating oil of the air line and solid foreign material of air lines.

3. SPECIFICATIONS

Model	AFM20	AFM30	AFM40	AFM40-06
Port size	1/8, 1/4	1/4, 3/8	1/4, 3/8, 1/2	3/4
Fluid	Air			
Proof pressure	1.5MPa			
Max. operating pressure	1.0MPa			
Min. operating pressure	0.05MPa			
Ambient and fluid temperature	-5~60°C(Should be no freezing)			
Note1) Flow rate[L/min(ANR)]	200	450	1100	1100
Filtration	0.3 μm(FILTRATION EFECIENCY 99.9%)			
Note2) Oil mist density at the out side	MAX.1.0mg/m ³ (ANR)(≒0.8ppm)			
Element life expectancy	For 2 years or when pressure drop reaches 0.1MPa			
Drain capacity (cm ³)	8	25	45	45
Mass (kg)	0.10	0.22	0.44	0.49
Note3) Bowl guard	△	○	○	○

Note1)The inlet pressure is 0.7MPa. (The rated flow is different according to the inlet pressure.)

Note2)When oil mist density of the compressor exhaust is 30mgf/Nm³(ANR).

A little amount of grease is used for bowl O ring and other O rings.

Note3)○: Combinable to standard △: Combinable to option

4. HOW TO ORDER

AFM 30 - F 03 BC -2R

Mist separator

Body size

20
30
40

Thread

NIL	Rc
Note1) N	NPT
Note2) F	G

Note1) Drain guide(Bore size): NPT 1/8(AFM20)
NPT 1/4(AFM30,40)
Auto drain exhaust port size: With φ 3/8" one-touch fitting (Applicable AFM30,40).
Note2) Drain guide(Bore size): G 1/8(AFM20)
G 1/4(AFM30,40)

Port size

01	1/8
02	1/4
03	3/8
04	1/2
06	3/4

Option

Symbol	Description	Applicable model
2	Metal bowl	AFM20~40
6	Nylon bowl	AFM20~40
8	Metal bowl with sight glass	AFM30,40
C	Bowl guard	AFM20
Note4) J	With drain guide 1/8	AFM20
	With drain guide 1/4	AFM30,40
R	Flow direction: From right to left	AFM20~40
W	With drain cock and barb fitting (For nylon φ 6 × φ 4)	AFM30,40
Note5) Z	Nameplate, Pressure gauge Unit: psi · ° F	AFM20~40

When specifying more than one option, indicate symbols numerically then alphabetically.
Note4) Without valve function.
Note5) Thread: NPT
Z is applicable to only overseas because of new measurement law in Japan(SI unit).

Accessory

Symbol	Description	Applicable model
Nil	—	—
Note3) B	With Bracket	AFM20~40
C	With float auto drain (N.C.)	AFM20~40
D	With float auto drain (N.O.)	AFM30,40

Note3) Bracket is packed together and is not mounted.

5. MAXIMUM APPLICABLE FLOW RATE

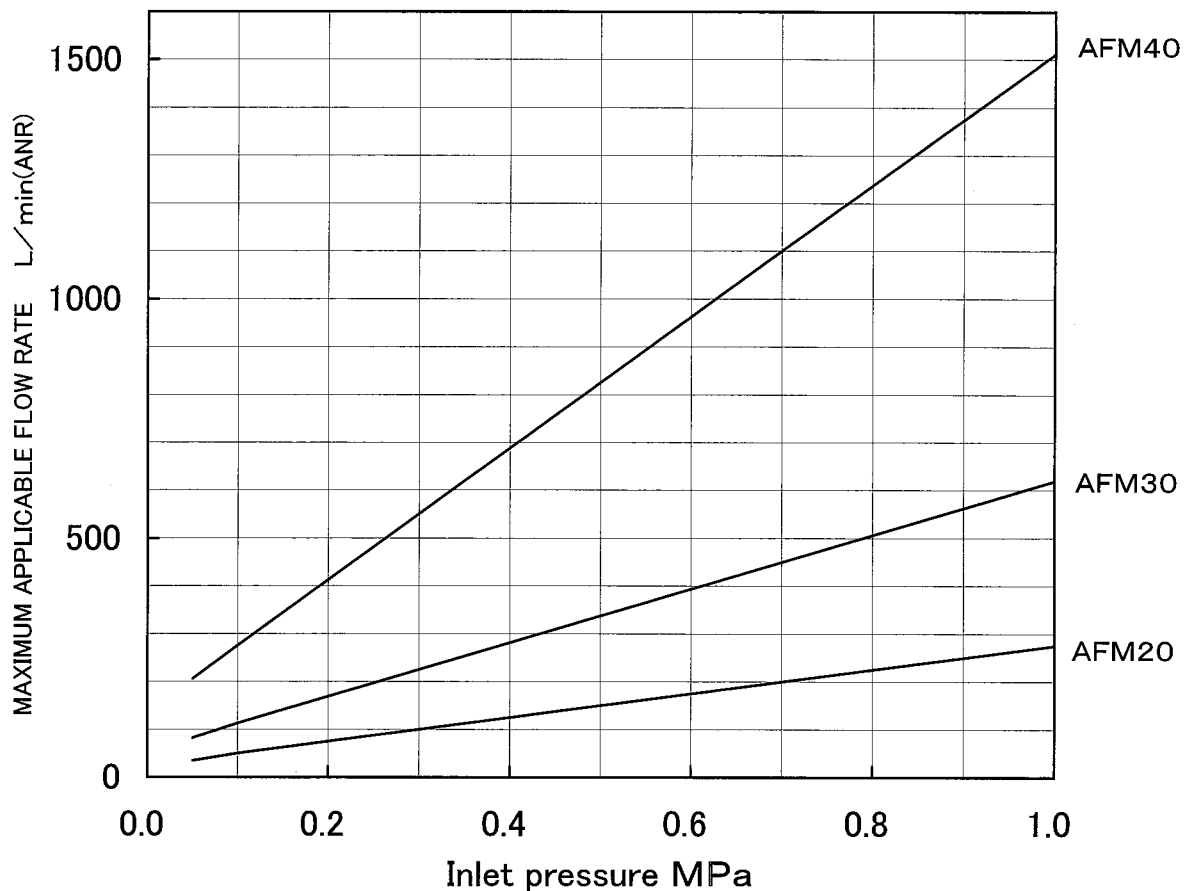

6. TROUBLESHOOTING

Refer to 「7.CONSTRUCTION」(P7),「10.DISASSEMBLY DRAWING」(P12~P13).

TROUBLE		POSSIBLE CAUSE	REMEDY
Demarcation	Phenomenon		
Flow rate	Large air resistance reduces flow rate.	1. Clog of the element.	1. Replace the element.
	Air leaks from the bowl and the body.	1. Breakage of "O" ring.	1. Replace the "O" ring. Grease up before assembling.
Air leaks	Air leaks from the bowl.	1. Breakage of bowl.	1. Replace the bowl assembly or with metal bowl.
	Air leaks from the drain cock.	1. The foreign matter caught in the valve of the drain cock. the drain cock. 2. Breakage of the seating part of the drain cock	1. Open the drain cock for a few seconds for blowing. 2. Replace the bowl assembly.
Operational	Draining isn't perfumed though the drain cock is opened.	1. Clock of outlet of the drain cock due to solid foreign matter etc.	1. Replace the bowl assembly.
	Too much drain comes from the piping of outlet side.	1. Drain level reaches the element assembly.	1. Open the drain cock for draining and replace the element assembly.

Note) The grease used recommends JX Nippon oil & Energy corporation diamond multipurpose No.2.

7. CONSTRUCTION/PARTS LIST

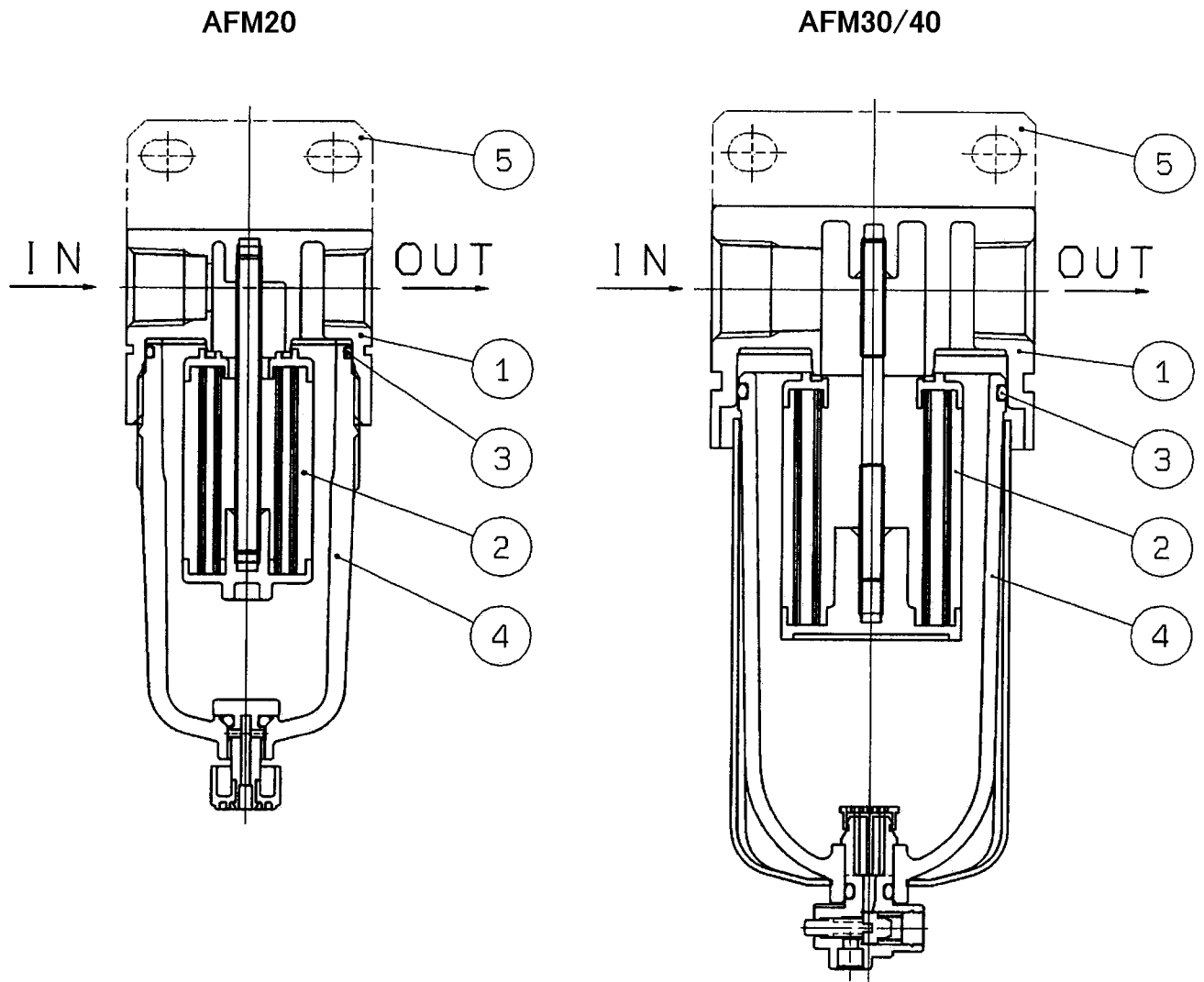

Component Parts

	Description	Material			Note
		AFM20	AFM30	AFM40(-06)	
①	Body	Aluminium die cast			Painted platinum silver

Option/Replacement Parts

	Description	Material	Part no.			
			AFM20	AFM30	AFM40	AFM40-06
②	Element assembly	-	AFM20P-060AS	AFM30P-060AS	AFM40P-060AS	AFM40P-060AS
③	Bowl O ring	NBR	C2SFP-260S	C3SFP-260S	C4SFP-260S	C4SFP-260S
④	Bowl assembly	Refer to 「8. SPECIFICATIONS OF BOWL ASSEMBLY」 (P8~P10).				
	Auto drain (N.C.)					
	Auto drain (N.O.)					
⑤	^{Note1)} Bracket assembly	Steel plate	AF20P-050AS	AF30P-050AS	AF40P-050AS	AF40P-070AS

Note1) Bracket with mounting screws.(2pcs)

Note2) The number in the table is corresponding to the number in structural drawing (above-mentioned figure) and 「8.SPECIFICATIONS OF BOWL ASSEMBLY」(P8~P10),「10.DISASSEMBLY DRAWING」 (P12~P13)

8. SPECIFICATIONS OF BOWL ASSEMBLY

1) Bowl assembly/Auto drain for AFM20

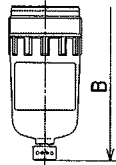
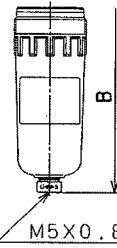
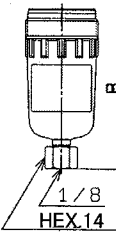
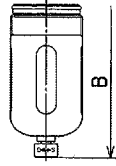
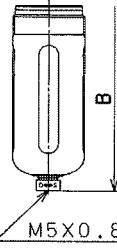
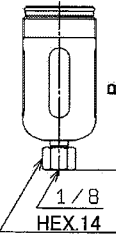
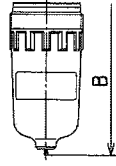
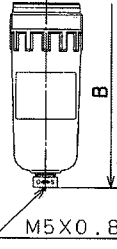
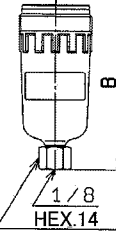
Accessory	—		Note2) C		—																																																													
Option	6		6		6J																																																													
External appearance drawing																																																																		
Part no.	<table border="1"> <tr><td>Option 「-」 (Standard)</td><td>④Part no.</td></tr> <tr><td>Port thread</td><td>C2SF</td></tr> <tr><td>Rc</td><td>C2SF</td></tr> <tr><td>G</td><td>C2SF(-Z)</td></tr> <tr><td>NPT</td><td>C2SF(-Z)</td></tr> </table> <table border="1"> <tr><td>Option 「6」</td><td>④Part no.</td></tr> <tr><td>Port thread</td><td>C2SF-6</td></tr> <tr><td>Rc</td><td>C2SF-6</td></tr> <tr><td>G</td><td>C2SF-6(Z)</td></tr> <tr><td>NPT</td><td>C2SF-6(Z)</td></tr> </table>		Option 「-」 (Standard)	④Part no.	Port thread	C2SF	Rc	C2SF	G	C2SF(-Z)	NPT	C2SF(-Z)	Option 「6」	④Part no.	Port thread	C2SF-6	Rc	C2SF-6	G	C2SF-6(Z)	NPT	C2SF-6(Z)	<table border="1"> <tr><td>Option 「-」</td><td>④Part no.</td></tr> <tr><td>Port thread</td><td>AD27</td></tr> <tr><td>Rc</td><td>AD27</td></tr> <tr><td>G</td><td>AD27(-Z)</td></tr> <tr><td>NPT</td><td>AD27(-Z)</td></tr> </table> <table border="1"> <tr><td>Option 「6」</td><td>④Part no.</td></tr> <tr><td>Port thread</td><td>AD27-6</td></tr> <tr><td>Rc</td><td>AD27-6</td></tr> <tr><td>G</td><td>AD27-6(Z)</td></tr> <tr><td>NPT</td><td>AD27-6(Z)</td></tr> </table>		Option 「-」	④Part no.	Port thread	AD27	Rc	AD27	G	AD27(-Z)	NPT	AD27(-Z)	Option 「6」	④Part no.	Port thread	AD27-6	Rc	AD27-6	G	AD27-6(Z)	NPT	AD27-6(Z)	<table border="1"> <tr><td>Option 「J」</td><td>④Part no.</td></tr> <tr><td>Port thread</td><td>C2SF-J</td></tr> <tr><td>Rc</td><td>C2SF-J</td></tr> <tr><td>G</td><td>C2SFF-J</td></tr> <tr><td>NPT</td><td>C2SFN-J(Z)</td></tr> </table> <table border="1"> <tr><td>Option 「6J」</td><td>④Part no.</td></tr> <tr><td>Port thread</td><td>C2SF-6J</td></tr> <tr><td>Rc</td><td>C2SF-6J</td></tr> <tr><td>G</td><td>C2SFF-6J</td></tr> <tr><td>NPT</td><td>C2SFN-6J(Z)</td></tr> </table>		Option 「J」	④Part no.	Port thread	C2SF-J	Rc	C2SF-J	G	C2SFF-J	NPT	C2SFN-J(Z)	Option 「6J」	④Part no.	Port thread	C2SF-6J	Rc	C2SF-6J	G	C2SFF-6J	NPT	C2SFN-6J(Z)
Option 「-」 (Standard)	④Part no.																																																																	
Port thread	C2SF																																																																	
Rc	C2SF																																																																	
G	C2SF(-Z)																																																																	
NPT	C2SF(-Z)																																																																	
Option 「6」	④Part no.																																																																	
Port thread	C2SF-6																																																																	
Rc	C2SF-6																																																																	
G	C2SF-6(Z)																																																																	
NPT	C2SF-6(Z)																																																																	
Option 「-」	④Part no.																																																																	
Port thread	AD27																																																																	
Rc	AD27																																																																	
G	AD27(-Z)																																																																	
NPT	AD27(-Z)																																																																	
Option 「6」	④Part no.																																																																	
Port thread	AD27-6																																																																	
Rc	AD27-6																																																																	
G	AD27-6(Z)																																																																	
NPT	AD27-6(Z)																																																																	
Option 「J」	④Part no.																																																																	
Port thread	C2SF-J																																																																	
Rc	C2SF-J																																																																	
G	C2SFF-J																																																																	
NPT	C2SFN-J(Z)																																																																	
Option 「6J」	④Part no.																																																																	
Port thread	C2SF-6J																																																																	
Rc	C2SF-6J																																																																	
G	C2SFF-6J																																																																	
NPT	C2SFN-6J(Z)																																																																	
Accessory	—		Note2) C		—																																																													
Option	6C		6C		6CJ																																																													
External appearance drawing																																																																		
Part no.	<table border="1"> <tr><td>Option 「C」</td><td>④Part no.</td></tr> <tr><td>Port thread</td><td>C2SF-C</td></tr> <tr><td>Rc</td><td>C2SF-C</td></tr> <tr><td>G</td><td>C2SF-C(Z)</td></tr> <tr><td>NPT</td><td>C2SF-C(Z)</td></tr> </table> <table border="1"> <tr><td>Option 「6C」</td><td>④Part no.</td></tr> <tr><td>Port thread</td><td>C2SF-6C</td></tr> <tr><td>Rc</td><td>C2SF-6C</td></tr> <tr><td>G</td><td>C2SF-6C(Z)</td></tr> <tr><td>NPT</td><td>C2SF-6C(Z)</td></tr> </table>		Option 「C」	④Part no.	Port thread	C2SF-C	Rc	C2SF-C	G	C2SF-C(Z)	NPT	C2SF-C(Z)	Option 「6C」	④Part no.	Port thread	C2SF-6C	Rc	C2SF-6C	G	C2SF-6C(Z)	NPT	C2SF-6C(Z)	<table border="1"> <tr><td>Option 「C」</td><td>④Part no.</td></tr> <tr><td>Port thread</td><td>AD27-C</td></tr> <tr><td>Rc</td><td>AD27-C</td></tr> <tr><td>G</td><td>AD27-C(Z)</td></tr> <tr><td>NPT</td><td>AD27-C(Z)</td></tr> </table> <table border="1"> <tr><td>Option 「6C」</td><td>④Part no.</td></tr> <tr><td>Port thread</td><td>AD27-6C</td></tr> <tr><td>Rc</td><td>AD27-6C</td></tr> <tr><td>G</td><td>AD27-6C(Z)</td></tr> <tr><td>NPT</td><td>AD27-6C(Z)</td></tr> </table>		Option 「C」	④Part no.	Port thread	AD27-C	Rc	AD27-C	G	AD27-C(Z)	NPT	AD27-C(Z)	Option 「6C」	④Part no.	Port thread	AD27-6C	Rc	AD27-6C	G	AD27-6C(Z)	NPT	AD27-6C(Z)	<table border="1"> <tr><td>Option 「CJ」</td><td>④Part no.</td></tr> <tr><td>Port thread</td><td>C2SF-CJ</td></tr> <tr><td>Rc</td><td>C2SF-CJ</td></tr> <tr><td>G</td><td>C2SFF-CJ</td></tr> <tr><td>NPT</td><td>C2SFN-CJ(Z)</td></tr> </table> <table border="1"> <tr><td>Option 「6CJ」</td><td>④Part no.</td></tr> <tr><td>Port thread</td><td>C2SF-6CJ</td></tr> <tr><td>Rc</td><td>C2SF-6CJ</td></tr> <tr><td>G</td><td>C2SFF-6CJ</td></tr> <tr><td>NPT</td><td>C2SFN-6CJ(Z)</td></tr> </table>		Option 「CJ」	④Part no.	Port thread	C2SF-CJ	Rc	C2SF-CJ	G	C2SFF-CJ	NPT	C2SFN-CJ(Z)	Option 「6CJ」	④Part no.	Port thread	C2SF-6CJ	Rc	C2SF-6CJ	G	C2SFF-6CJ	NPT	C2SFN-6CJ(Z)
Option 「C」	④Part no.																																																																	
Port thread	C2SF-C																																																																	
Rc	C2SF-C																																																																	
G	C2SF-C(Z)																																																																	
NPT	C2SF-C(Z)																																																																	
Option 「6C」	④Part no.																																																																	
Port thread	C2SF-6C																																																																	
Rc	C2SF-6C																																																																	
G	C2SF-6C(Z)																																																																	
NPT	C2SF-6C(Z)																																																																	
Option 「C」	④Part no.																																																																	
Port thread	AD27-C																																																																	
Rc	AD27-C																																																																	
G	AD27-C(Z)																																																																	
NPT	AD27-C(Z)																																																																	
Option 「6C」	④Part no.																																																																	
Port thread	AD27-6C																																																																	
Rc	AD27-6C																																																																	
G	AD27-6C(Z)																																																																	
NPT	AD27-6C(Z)																																																																	
Option 「CJ」	④Part no.																																																																	
Port thread	C2SF-CJ																																																																	
Rc	C2SF-CJ																																																																	
G	C2SFF-CJ																																																																	
NPT	C2SFN-CJ(Z)																																																																	
Option 「6CJ」	④Part no.																																																																	
Port thread	C2SF-6CJ																																																																	
Rc	C2SF-6CJ																																																																	
G	C2SFF-6CJ																																																																	
NPT	C2SFN-6CJ(Z)																																																																	
Accessory	—		Note2) C		—																																																													
Option	2		2		2J																																																													
External appearance drawing																																																																		
Part no.	<table border="1"> <tr><td>Port thread</td><td>④Part no.</td></tr> <tr><td>Rc</td><td>C2SF-2</td></tr> <tr><td>G</td><td>C2SF-2</td></tr> <tr><td>NPT</td><td>C2SF-2(Z)</td></tr> </table>		Port thread	④Part no.	Rc	C2SF-2	G	C2SF-2	NPT	C2SF-2(Z)	<table border="1"> <tr><td>Port thread</td><td>④Part no.</td></tr> <tr><td>Rc</td><td>AD27-2</td></tr> <tr><td>G</td><td>AD27-2</td></tr> <tr><td>NPT</td><td>AD27-2(Z)</td></tr> </table>		Port thread	④Part no.	Rc	AD27-2	G	AD27-2	NPT	AD27-2(Z)	<table border="1"> <tr><td>Port thread</td><td>④Part no.</td></tr> <tr><td>Rc</td><td>C2SF-2J</td></tr> <tr><td>G</td><td>C2SFF-2J</td></tr> <tr><td>NPT</td><td>C2SFN-2J(Z)</td></tr> </table>		Port thread	④Part no.	Rc	C2SF-2J	G	C2SFF-2J	NPT	C2SFN-2J(Z)																																				
Port thread	④Part no.																																																																	
Rc	C2SF-2																																																																	
G	C2SF-2																																																																	
NPT	C2SF-2(Z)																																																																	
Port thread	④Part no.																																																																	
Rc	AD27-2																																																																	
G	AD27-2																																																																	
NPT	AD27-2(Z)																																																																	
Port thread	④Part no.																																																																	
Rc	C2SF-2J																																																																	
G	C2SFF-2J																																																																	
NPT	C2SFN-2J(Z)																																																																	

Note 1) B in the table shows full dimensions of the product. Refer to 「11. DIMENSIONS」 (P14).



Note 2) Min. operating pressure is 0.1MPa .

Note 3) The part with no. ④ includes ③ Bowl O ring. Refer to 「10. DISASSEMBLY DRAWING」 (P12~P13).

Note 4) "Z" of the part with no. ④ is semi-standard for indicated unit of pressure and temperature, which is psi and ° F

Note 5) The symbol for option and semi-standard are described as 「4. HOW TO ORDER」(P5).

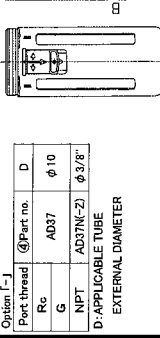
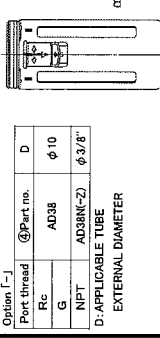
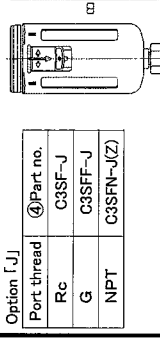
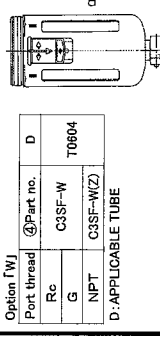
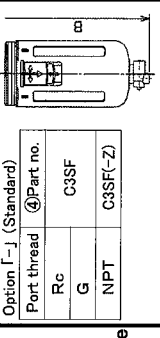
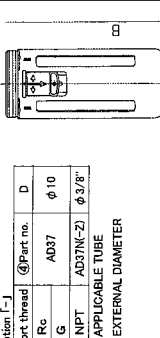
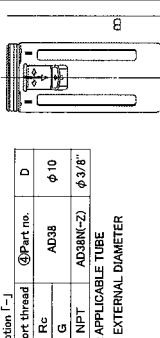
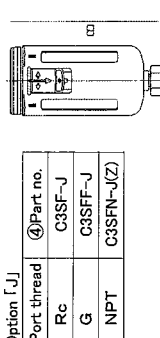
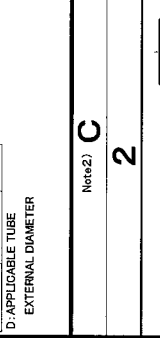
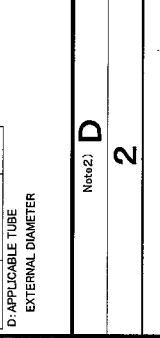
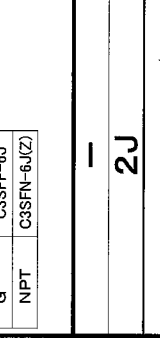
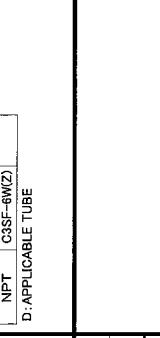
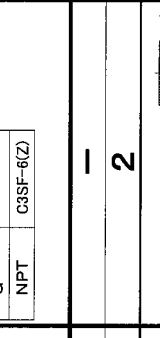
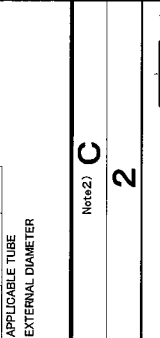
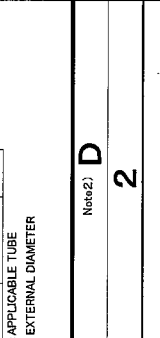
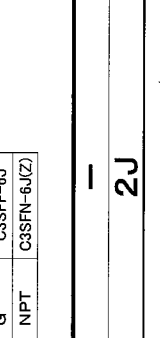
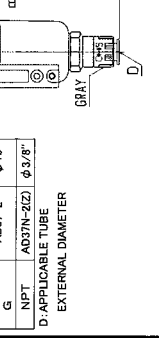
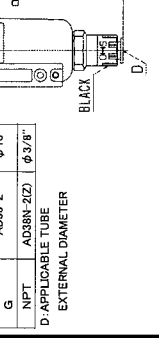
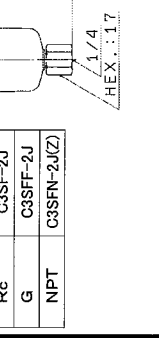
2) Bowl assembly/Auto drain for AFM30

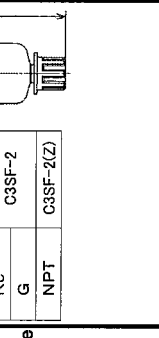
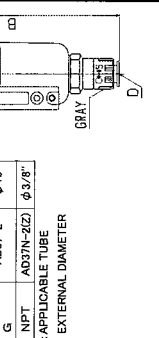
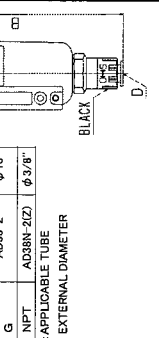
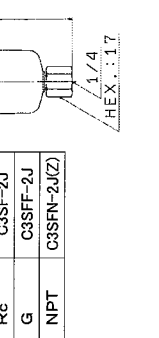



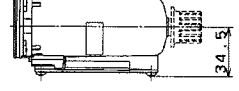

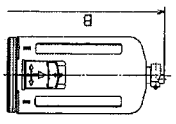
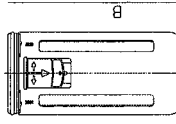
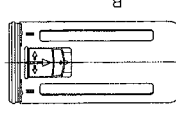
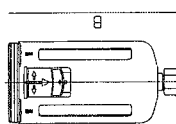
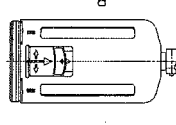
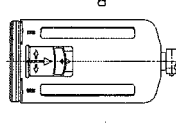
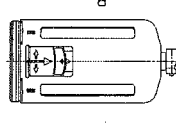
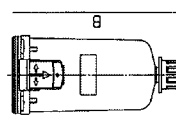
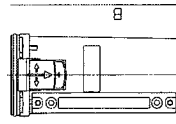
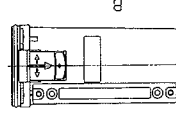
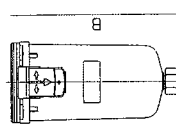

Accessory	C		D		J	W	6W	
Option	6		6		6J	6	6W	
External appearance drawing								
Part no.	Option [r-j] Port thread Rc G NPT D: APPLICABLE TUBE EXTERNAL DIAMETER	Option [f-j] Port thread Rc G NPT D: APPLICABLE TUBE EXTERNAL DIAMETER	Option [r-j] Port thread Rc G NPT D: APPLICABLE TUBE EXTERNAL DIAMETER	Option [f-j] Port thread Rc G NPT D: APPLICABLE TUBE EXTERNAL DIAMETER	Option [r-j] Port thread Rc G NPT D: APPLICABLE TUBE EXTERNAL DIAMETER	Option [f-j] Port thread Rc G NPT D: APPLICABLE TUBE EXTERNAL DIAMETER	Option [r-j] Port thread Rc G NPT D: APPLICABLE TUBE EXTERNAL DIAMETER	Option [f-j] Port thread Rc G NPT D: APPLICABLE TUBE EXTERNAL DIAMETER
Accessory	2		2		2J	2	2	2J
Option	6		6		6J	6	6	6J
External appearance drawing								
Part no.	Option [r-j] Port thread Rc G NPT D: APPLICABLE TUBE EXTERNAL DIAMETER	Option [f-j] Port thread Rc G NPT D: APPLICABLE TUBE EXTERNAL DIAMETER	Option [r-j] Port thread Rc G NPT D: APPLICABLE TUBE EXTERNAL DIAMETER	Option [f-j] Port thread Rc G NPT D: APPLICABLE TUBE EXTERNAL DIAMETER	Option [r-j] Port thread Rc G NPT D: APPLICABLE TUBE EXTERNAL DIAMETER	Option [f-j] Port thread Rc G NPT D: APPLICABLE TUBE EXTERNAL DIAMETER	Option [r-j] Port thread Rc G NPT D: APPLICABLE TUBE EXTERNAL DIAMETER	Option [f-j] Port thread Rc G NPT D: APPLICABLE TUBE EXTERNAL DIAMETER
Accessory	8		8		8J	8	8	8J
Option	6		6		6J	6	6	6J
External appearance drawing								
Part no.	Option [r-j] Port thread Rc G NPT D: APPLICABLE TUBE EXTERNAL DIAMETER	Option [f-j] Port thread Rc G NPT D: APPLICABLE TUBE EXTERNAL DIAMETER	Option [r-j] Port thread Rc G NPT D: APPLICABLE TUBE EXTERNAL DIAMETER	Option [f-j] Port thread Rc G NPT D: APPLICABLE TUBE EXTERNAL DIAMETER	Option [r-j] Port thread Rc G NPT D: APPLICABLE TUBE EXTERNAL DIAMETER	Option [f-j] Port thread Rc G NPT D: APPLICABLE TUBE EXTERNAL DIAMETER	Option [r-j] Port thread Rc G NPT D: APPLICABLE TUBE EXTERNAL DIAMETER	Option [f-j] Port thread Rc G NPT D: APPLICABLE TUBE EXTERNAL DIAMETER

Metal bowl with sight glass

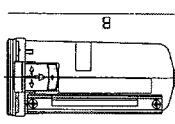
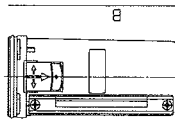
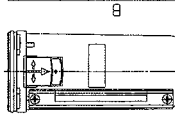
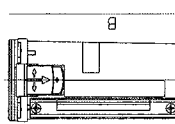

Note 1) B in the table shows full dimensions of the product. Refer to [11. DIMENSIONS] (P14).
 Note 2) Min. operating pressure is 0.15MPa for N.C. type and 0.1MPa for N.O. type.
 Note 3) The part with no. ④ includes ③ Bowl O ring. Refer to [10. DISASSEMBLY DRAWING] (P12~P13).
 Note 4) "Z" of the part with no. ④ is semi-standard for indicated unit of pressure and temperature, which is psi and ° F.
 Note 5) The symbol for option and semi-standard are described as [4. HOW TO ORDER] (P5).

3) Bowl assembly/Auto drain for AFM40

Accessory	C		D		J	W	6W
Option	6		6		6J	6J	6J
External appearance drawing							
Part no.	Option [J] (Standard) Port thread ④ Part no. Rc C4SF G C4SF(-Z) NPT C4SF(-Z)	Option [J] (Standard) Port thread ④ Part no. Rc AD47 G AD47(-Z) NPT AD47N(-Z) D: APPLICABLE TUBE EXTERNAL DIAMETER	Option [J] (Standard) Port thread ④ Part no. Rc AD48 G AD48(-Z) NPT AD48N(-Z) D: APPLICABLE TUBE EXTERNAL DIAMETER	Option [J] (Standard) Port thread ④ Part no. Rc AD48-6 G AD48N-6(Z) NPT AD48N-6(Z) D: APPLICABLE TUBE EXTERNAL DIAMETER	Option [J] Port thread ④ Part no. Rc C4SF-J G C4SFF-J NPT C4SFN-J(Z)	Option [J] Port thread ④ Part no. Rc C4SF-6J G C4SFF-6J NPT C4SFN-6J(Z)	Option [W] Port thread ④ Part no. Rc C4SF-W G C4SF-W(Z) NPT C4SF-W(Z) D: APPLICABLE TUBE
Accessory	2		2		2J		
Option	6		6		6J		
External appearance drawing							
Part no.	Option [J] Port thread ④ Part no. Rc C4SF-2 G C4SF-2(Z) NPT C4SF-2(Z)	Option [J] Port thread ④ Part no. Rc AD47-2 G AD47N-2(Z) NPT AD47N-2(Z) D: APPLICABLE TUBE EXTERNAL DIAMETER	Option [J] Port thread ④ Part no. Rc AD48-2 G AD48N-2(Z) NPT AD48N-2(Z) D: APPLICABLE TUBE EXTERNAL DIAMETER	Option [J] Port thread ④ Part no. Rc AD48-2J G C4SFF-2J NPT C4SFN-2J(Z)	Option [W] Port thread ④ Part no. Rc C4SF-W G C4SF-W(Z) NPT C4SF-W(Z) D: APPLICABLE TUBE	Option [W] Port thread ④ Part no. Rc C4SF-W G C4SF-W(Z) NPT C4SF-W(Z) D: APPLICABLE TUBE	Option [W] Port thread ④ Part no. Rc C4SF-W G C4SF-W(Z) NPT C4SF-W(Z) D: APPLICABLE TUBE
Accessory	8		8		8J		
Option	6		6		6J		
External appearance drawing							
Part no.	Option [J] Port thread ④ Part no. Rc C4LF-8 G C4LF-8(Z) NPT C4LF-8(Z)	Option [J] Port thread ④ Part no. Rc AD47-8 G AD47N-8(Z) NPT AD47N-8(Z) D: APPLICABLE TUBE EXTERNAL DIAMETER	Option [J] Port thread ④ Part no. Rc AD48-8 G AD48N-8(Z) NPT AD48N-8(Z) D: APPLICABLE TUBE EXTERNAL DIAMETER	Option [J] Port thread ④ Part no. Rc C4LF-8J G C4LFF-8J NPT C4LFN-8J(Z)	Option [W] Port thread ④ Part no. Rc C4SF-W G C4SF-W(Z) NPT C4SF-W(Z) D: APPLICABLE TUBE	Option [W] Port thread ④ Part no. Rc C4SF-W G C4SF-W(Z) NPT C4SF-W(Z) D: APPLICABLE TUBE	Option [W] Port thread ④ Part no. Rc C4SF-W G C4SF-W(Z) NPT C4SF-W(Z) D: APPLICABLE TUBE

Metal bowl with sight glass

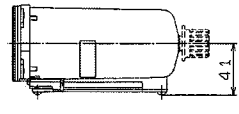

Note 1) B in the table shows full dimensions of the product. Refer to [11. DIMENSIONS] (P14).
 Note 2) Min. operating pressure is 0.15MPa for N.C. type and 0.1MPa for N.O. type.
 Note 3) The part with no. ④ includes ③ Bowl O ring. Refer to [10. DISASSEMBLY DRAWING] (P12~P13).
 Note 4) "Z" of the part with no. ④ is semi-standard for indicated unit of pressure and temperature, which is psi and ° F.
 Note 5) The symbol for option and semi-standard are described as [4. HOW TO ORDER] (P5).

9. REPLACEMENT PROCEDURE

WARNING

Before replacement, ensure that the regulator is not pressurized.

After replacement, ensure that specified function is satisfied and external leakage is not found before starting operation.

1) Bowl assembly/element

Applicable model	Process	Procedure	Tools	Check item
AFM20	Disassembly	1) Remove the bowl assembly Hold the bowl assembly by hand and rotate counterclockwise to remove the bowl assembly. If the bowl assembly is tightened too much to be removed, use hook spanner until it can be loosened by hand.	(Hook spanner Nominal: 34/38)	—
		2) Remove the element. Hold the element with a spanner to rotate it counterclockwise and remove the element.	Spanner Nominal: 7	—
	Assembly	3) Mount the element. Hold the element with a spanner to rotate it counterclockwise and remove the element. See check item for referential tightening torque.	Spanner Nominal: 7	Tightening torque: 0.35±0.05N·m
		4) Mount the bowl assembly. Hold the bowl assembly by hand and rotate clockwise. Do not use tool for mounting because the bowl may be damaged. See check item for referential tightening torque.	—	Referential tightening torque: 2.2 N·m
AFM30 AFM40	Disassembly	1) Remove the bowl assembly. Push the bowl assembly lock button. Lifting the bowl assembly, rotate the assembly 45 degree(right or left) to pull out the assembly.	—	—
		2) Remove the element. Hold the element with a round pliers to rotate it counterclockwise and remove the element.	Round pliers	—
	Assembly	3) Mount the element. Hold the element with a round pliers to rotate it counterclockwise and remove the element. See check item for referential tightening torque.	Round pliers	Tightening torque: 0.35±0.05N·m
		4) Mount the bowl assembly. Match the mating mark of the body and the bowl assembly to insert the assembly to the body. Rotate the assembly 45 degree(right or left) until the lock button is tossed up to mount the bowl assembly. Ensure the lock button is up.	—	Lock button is up.

10. DISASSEMBLY DRAWING

1)AFM20 Disassembly drawing

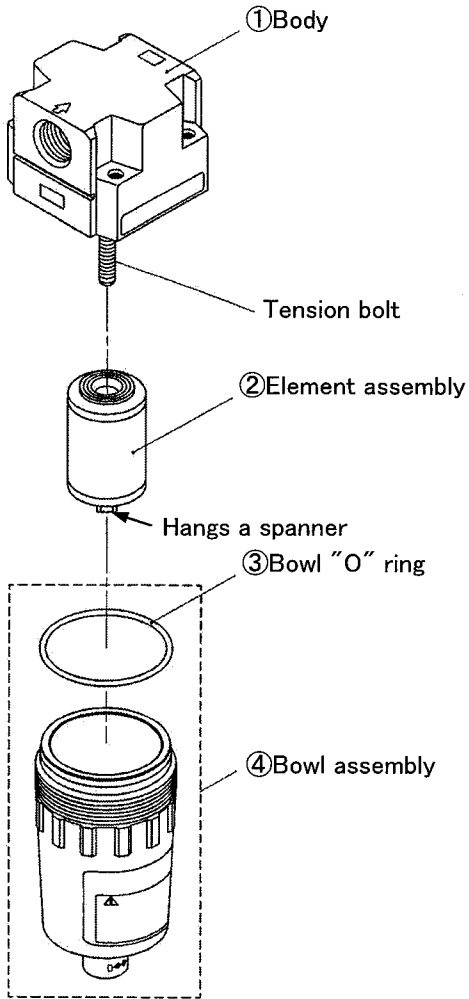

2)AFM30/40 Disassembly drawing

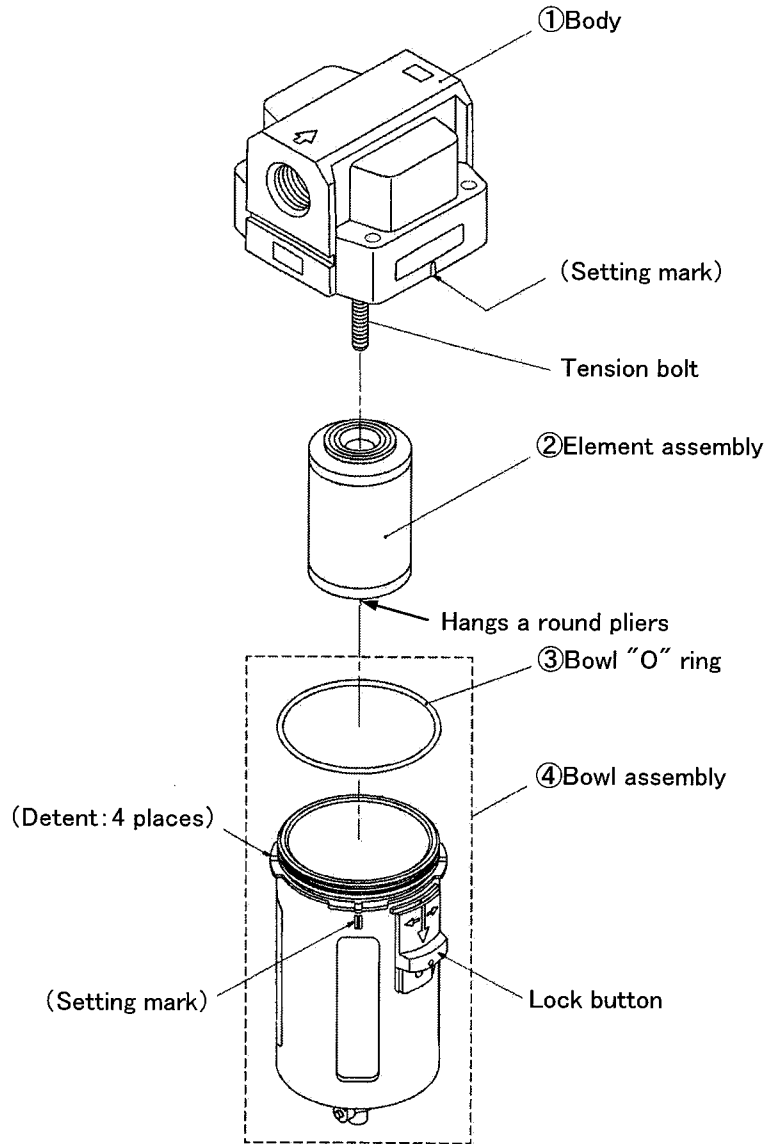

3)AFM20~40 Bracket assembly disassembly drawing

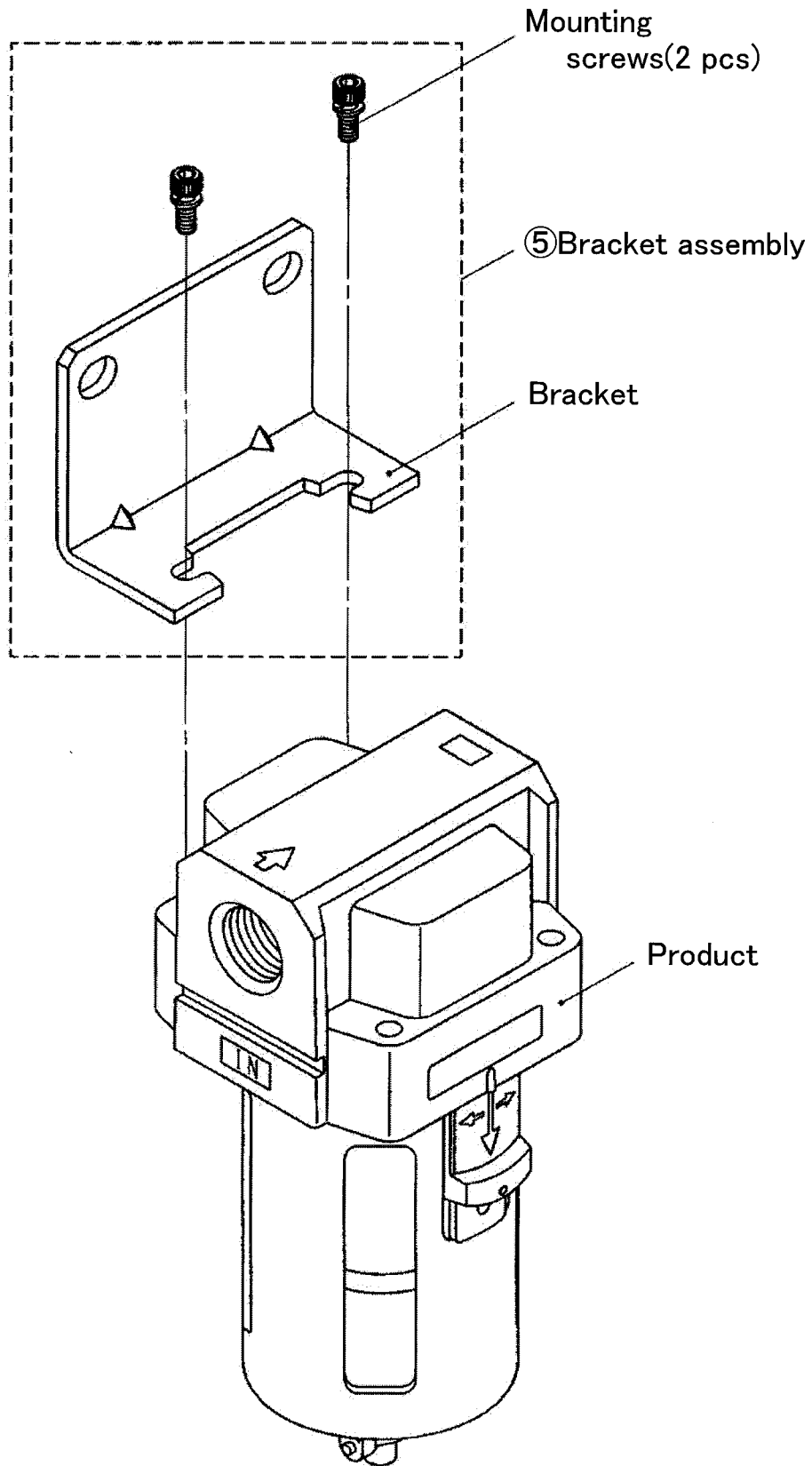

11. DIMENSIONS

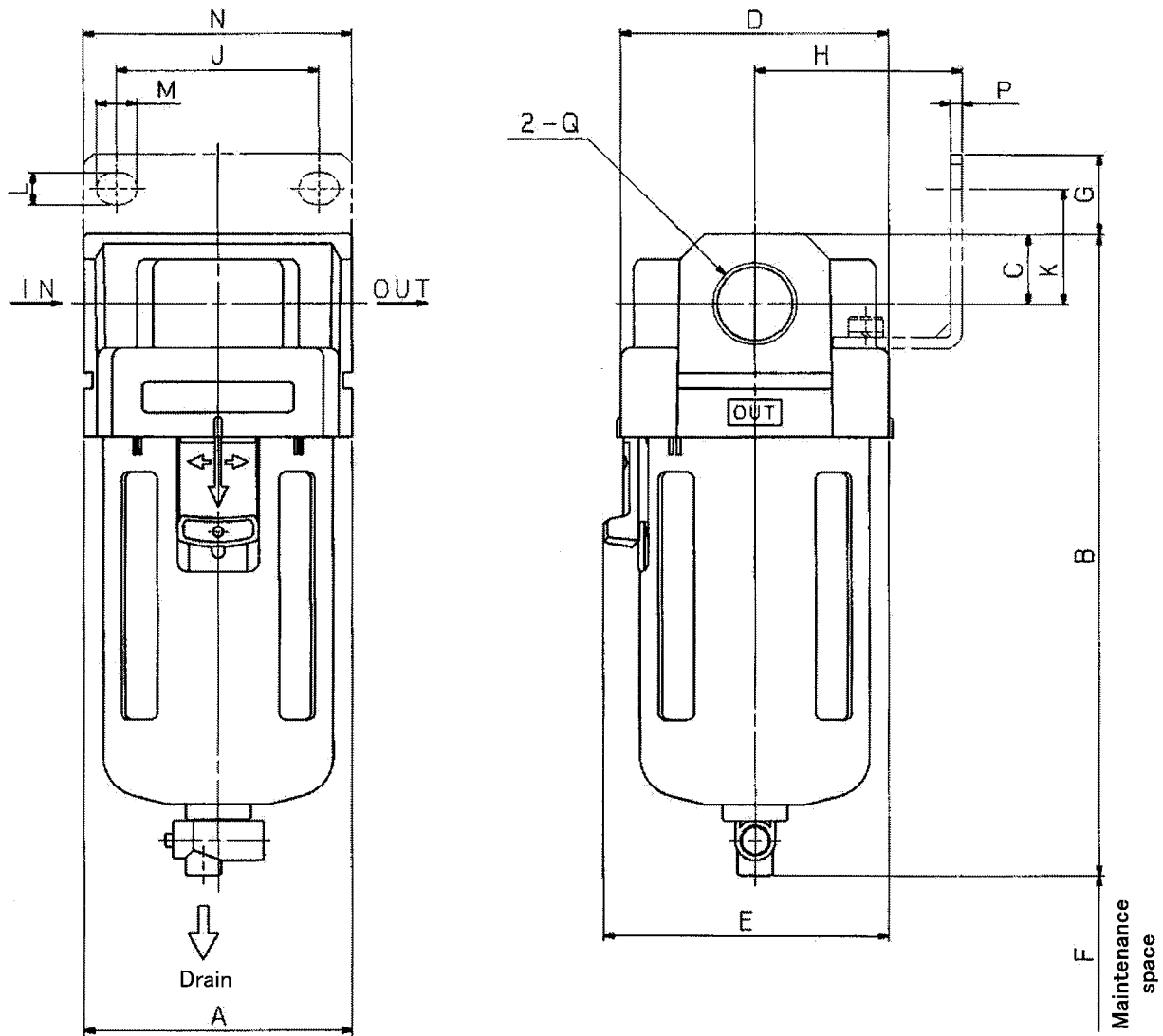

Model	Port size	Standard					Accessory							
		A	B	C	D	P	Bracket mounting dimensions							
							E	F	G	H	J	K	L	M
AFM20	1/8·1/4	40	97	10	40	40	18	30	27	22	5.4	8.4	40	2.3
AFM30	1/4·3/8	53	129	14	53	57	16	41	40	23	6.5	8	53	2.3
AFM40	1/4·3/8·1/2	70	165	18	70	73	17	50	54	26	8.5	10.5	70	2.3
AFM40-06	3/4	75	169	20	70	73	14	50	54	25	8.5	10.5	70	2.3

B for Auto-drain/Optional bowl assembly

Model	Accessory													C				D					
	2	6	8	C	6C	J	2J	6J	8J	CJ	6CJ	W	6W	-	2	6	8	C	6C	-	2	6	8
AFM20	97	97	-	97	97	101	104	101	-	101	101	-	-	115	115	115	-	115	115	-	-	-	-
AFM30	142	129	162	-	-	136	136	136	156	-	-	137	137	170	171	170	171	-	-	170	171	170	171
AFM40	178	165	198	-	-	172	172	172	192	-	-	173	173	204	207	204	207	-	-	204	207	204	207
AFM40-06	182	169	202	-	-	176	176	176	196	-	-	177	177	208	211	208	211	-	-	208	211	208	211

Note) The specifications of auto-drain and optional bowl assembly are described in 「8. SPECIFICATIONS OF BOWL ASSEMBLY」 (P8~P10).

Revision history

SMC Corporation

4-14-1, Sotokanda, Chiyoda-ku, Tokyo 101-0021 JAPAN

Tel: + 81 3 5207 8249 Fax: +81 3 5298 5362

URL <http://www.smcworld.com>

Note: Specifications are subject to change without prior notice and any obligation on the part of the manufacturer.
© 2008 SMC Corporation All Rights Reserved

