



HEC-OM-R008
Rev. F 2015 Sep

Installation and Maintenance Manual

Air Cooled Thermo Con for Rack Mount

HECR Series

Original Instructions



1 Read Before Using

Thank you for purchasing SMC's Thermo-con (hereinafter referred to as the "product"). This "Installation and Maintenance Manual" (hereinafter referred to as "this manual") briefly explains the essential safety instruction procedures to start and stop the product and reset its alarms. Read this manual before using.

2 Safety Instructions

This manual contains essential information for the protection of users and others from possible injury and/or equipment damage.

- Read this manual before using the product, to ensure correct handling, and read the manuals of related apparatus before use.
- Keep this manual in a safe place for future reference.
- These instructions indicate the level of potential hazard by label of "Caution", "Warning" or "Danger", followed by important safety information which must be carefully followed.
- To ensure safety of personnel and equipment the safety instructions in this manual and the product catalogue must be observed, along with other relevant safety practices.

	Caution	If instructions are not followed there is a possibility of injury or equipment damage.
	Warning	If instructions are not followed there is a possibility of serious injury or loss of life.
	Danger	In extreme conditions, there is a possibility of serious injury or loss of life.

- This manual provides the following symbols in addition to "Danger", "Warning", and "Caution" to present warning details in an easy-to-understand manner.

	This symbol warns you of potential electrical shock.
	This symbol warns you of potential burns.

Danger

- During operation or maintenance of the product, do not disable the interlock function of any device. Otherwise unexpected personnel injury or damage to the product may occur.
- When turning on/off the power observe the procedure. Otherwise unexpected malfunction or danger may occur.
- When maintaining, cleaning or in case of emergency, turn off the power source.
- After identifying a problem be sure to check the cause and take necessary countermeasures before turning on the power.
- The product is operated at high voltage.

Warning

- The compatibility of equipment is the responsibility of the person who designs the system or decides its specifications.** Since the products specified here can be used in various operating conditions, their compatibility with the specific system must be based on specifications or after analysis and/or tests to meet specific requirements.
- Only trained personnel should handle or operate the product.** Transportation, installation and maintenance of the product can be dangerous and should be done by persons who have full knowledge and experience on the product and system. Cover panels of the product should be opened only by qualified service technicians or qualified personnel.

- Do not modify or reconstruct the unit.**
- Read all warning and caution labels carefully and keep them in mind.** Do not peel off or rub alert warning and caution labels. Confirm locations of alert warning and caution labels.
- Do not service machinery/equipment or attempt to remove components until safety is confirmed.**

2 Safety Instructions Continued

- Inspection and maintenance of machinery/equipment should only be performed after confirmation of safe locked-out positions.
- When equipment is to be removed, confirm the safety process as mentioned above. Switch off electrical supplies and ensure any high temperature parts have cooled to ambient temperature.
- Before machinery/equipment is re-started, ensure all safety measures are taken so the product and system can be started in a safe manner.
- Do not use this product outdoor (indoor use).

Do not use this product outside of the specifications. Contact SMC if it is to be used in any of the following conditions.

- Conditions and environments beyond the given specifications.
 - Installations in conjunction with atomic energy, railway, air navigation, vehicles, medical equipment, food and beverage, recreation equipment, emergency stop circuits, press applications, or safety equipment.
- If abnormal conditions occur, such as abnormal noise or smoke, or water leakage, take the following actions.
 - Shut down power.
 - Contact an authorised SMC dealer for repair.

Caution

- After shutting down the power supply, ensure a time interval at least 3sec between ON and OFF. Restarting the product within that interval may cause it to malfunction.
- Do not use devices that generate electromagnetic radiation such as cellular phones near the product. There is a possibility that this can cause the product to malfunction.
- This unit has several interlock functions, which activate when a dangerous operation or condition occurs to stop the product and make it safe. This is a function to protect personnel and restrict operation that may cause damage to the product or facility, and to remove dangers related to safety.
- When dispose the product, contact an industrial waste disposal company for disposal of the product. To minimize the risk, drain the fluid from the product when it is scrapped. If the fluid is left inside, an accident and damage can result during transportation.

3 Specifications

3.1 General Description and Intended Use

This product uses a built in pump to circulate liquid (water or 20% EG) at a constant temperature, controlled by Thermo-Electric (Peltier) Modules. This circulating fluid cools parts of the customer's machine that generates heat.

3.2 General Specifications

Item	Spec.				
Model No.	HECR002	HECR004	HECR006	HECR008	HECR010
Operation temp. range	10.0 to 60.0 °C (No dew condensation)				
Indication temp. range	-9.9 to 80.0 °C				
Ambient environment	Temp: 10 to 35 °C Humidity: 35 to 80%RH Altitude: up to 1000m Environment: No corrosive gas, solvent such as thinner and flammable gas				
Storage environment	Temp: -40 to 70 °C (No dew condensation and icing) Humidity: 5 to 95%RH Environment: No corrosive gas, solvent such as thinner and flammable gas				
Accuracy related to temp	Indication accuracy: +/- 0.2 °C. Temperature drift: +/- 0.2 °C Stability: +/- 0.01 to 0.03 °C (Circulating fluid OUT is directly connected with IN)				
Cooling capacity (Set temperature 25°C and ambient temperature 25°C)	Approx. 200W (Flow rate 3L/min)	Approx. 400W (Flow rate 3L/min)	Approx. 510W (Flow rate 3L/min)	Approx. 800W (Flow rate 4L/min)	Approx. 1000W (Flow rate 4L/min)
Circulating fluid	Water, Ethylene glycol solution up to 20%				
Tank capacity	Approx. 1.3L				
Pump capacity	Refer to performance chart.				
Port size	IN/OUT: Rc1/4	IN/OUT: Rc3/8	IN/OUT: Rc3/8 Drain: CPC.PLCD16004		
Wetted materials	Stainless steel, EPDM, NBR, Ceramic, PPE, PPS, Carbon, Polyethylene, POM				
Power supply	Single phase AC100 to 240V(+/- 10%), 50/60Hz				Single phase AC200 to 240V (+/- 10%), 50/60Hz
Current consumption	Max.5A(100V) Max.2.5A(240V)	Max.9A(100V) Max.4A(240V)	Max.10A(100V) Max.4A(240V)	Max.8A (200V)	
Inrush current	50A or less				
Over current protection	10A circuit protector	14A circuit protector			
Voltage interruptions	20ms or less				
Insulation resistance	50MΩ or more (DC500V)				
Over voltage category	Category II				
Pollution degree	Pollution degree II				
Limitation of hazardous substance	RoHS compliant products				

3 Specifications Continued

Item	Spec.				
Model No.	HECR002	HECR004	HECR006	HECR008	HECR010
Acoustic noise	49dBA	54 to 62dBA	55 to 64dBA	54 to 65dBA (variable fan speed control)	
Cooling method	Air cooled				
Main functions	Auto tuning, Off set function, Learning control function, External tuning control function, Temperature sensor fine control function, Setting value memory function, Upper / lower temperature limit alarm function, Output shut off alarm, Communication, Fan speed control(HECR004,HECR006,HECR008,HECR010)				
Input operation and indications	Membrane key sheet LCD display panel (with back light) Output shut off alarm, Upper / lower temperature limit alarm : Relay contact specification DC30V, 2A (Resistance load) DC30V, 1A (Induction load)				
Communications	RS-232C / RS-485 Communications: Setting of target temperature, Reading of the value detected by temperature sensor, Reading of warning status, Setting and of off-set value, Setting and reading of control operation, Setting and reading of PID values, Reading of output ratio. For operation by communication, it is necessary to order "Communication Manual". Use shielded cable for serial communications.				
Temp. sensor	Resistance thermometer sensor (Pt1000, 3-wire, class A, 1mA) (Both internal sensor and external sensor)				
Painting color	Urban white				
Mass (at dry)	Approx 14kg	Approx 18kg	Approx 21kg	Approx 31kg	Approx 33kg
Option	With flow switch: Low flow rate alarm occurs at less than 0.7L/min NPT fitting: Fluid IN/OUT fittings With foot and no rack bracket High head pump				
Contents of package	Thermo-con 1pc Installation and Maintenance Manual 1pc Power supply connector 1pc				

3.3 Performance Charts

Values on the performance charts are not guaranteed values but representative values. Allow margins for safety when selecting the model.

3.3.1 Cooling Capacity

HECR002

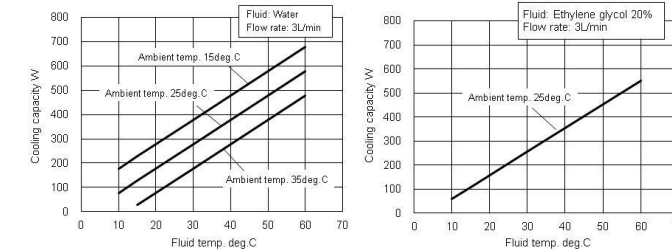

*Cooling capacity decrease about 20W when high head pump option selected.

HECR004

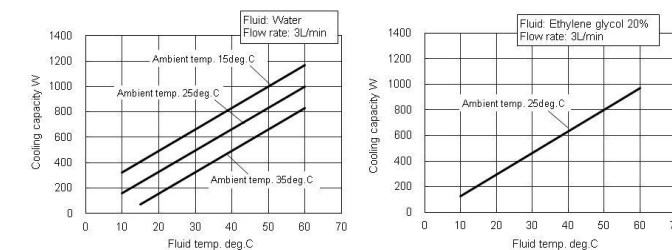

*Cooling capacity decrease about 50W when high head pump option selected.

HECR006

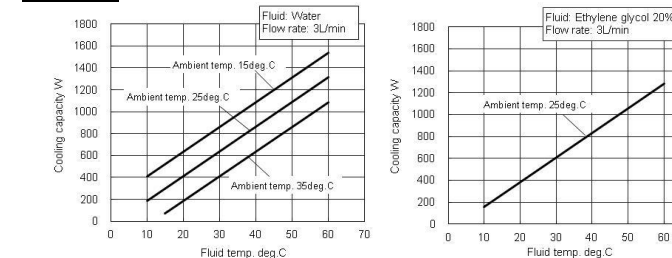

*Cooling capacity decrease about 50W when high head pump option selected.

3 Specifications Continued

HECR008

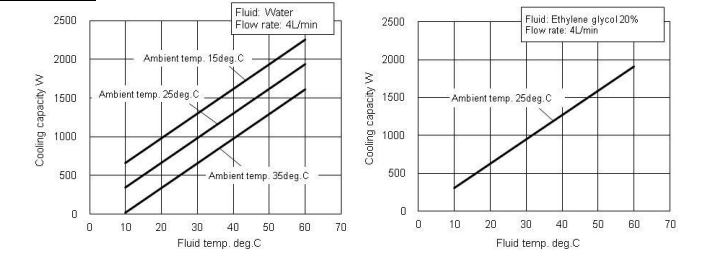

*Cooling capacity decrease about 50W when high head pump option selected.

HECR010

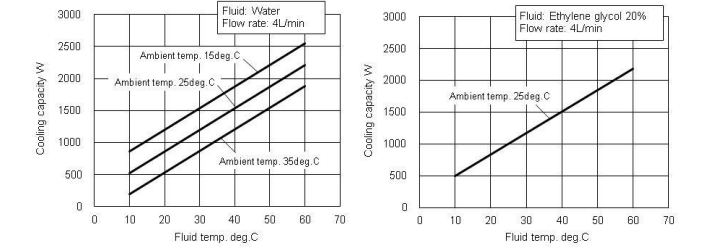

*Cooling capacity decrease about 50W when high head pump option selected.

3.3.2 Heating Capacity

HECR002

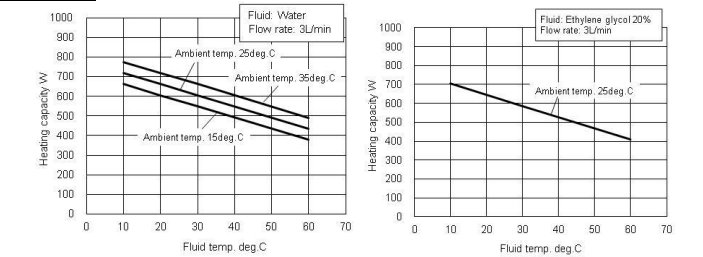

HECR004

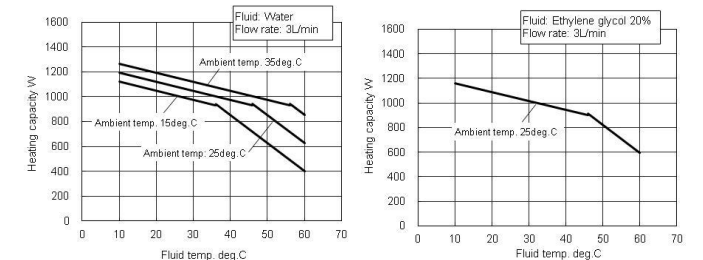

HECR006

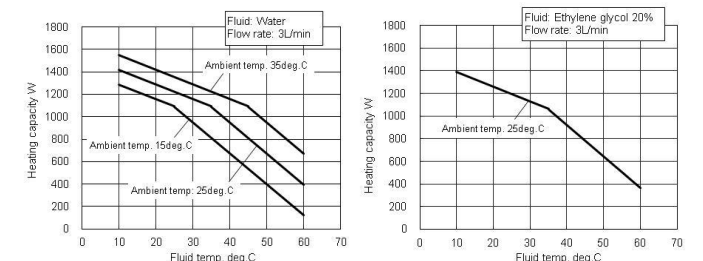

HECR008

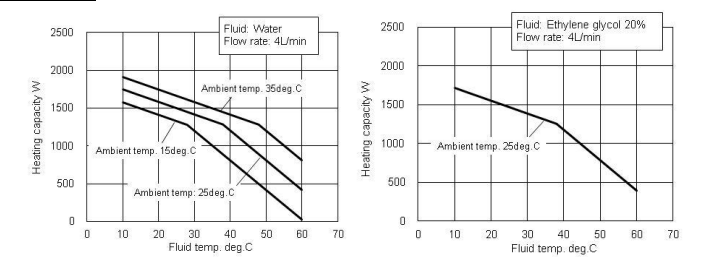

3 Specifications Continued

HECR010

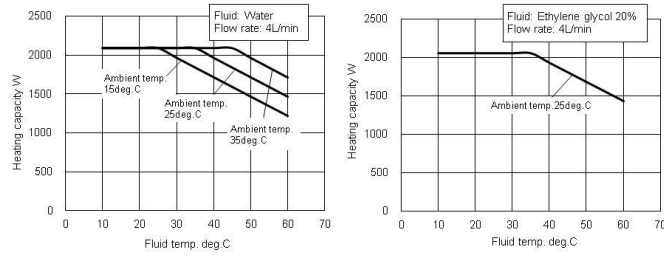

3.3.3 Pump Capacity

HECR002

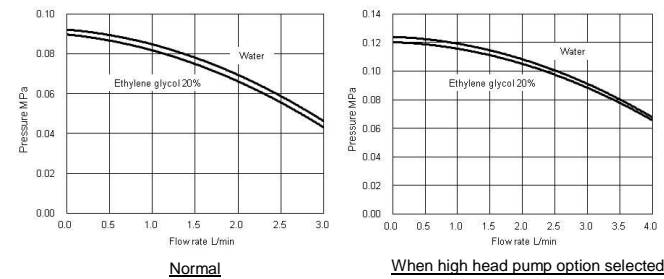

HECR004

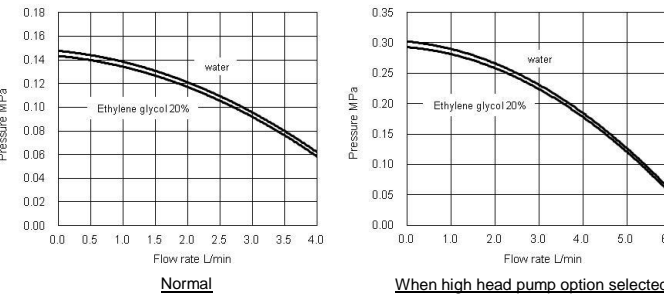

HECR006

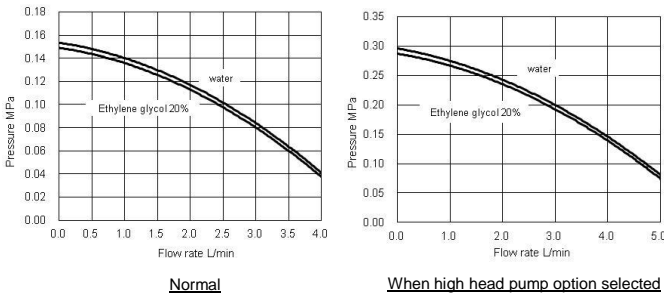

HECR008 / HECR010

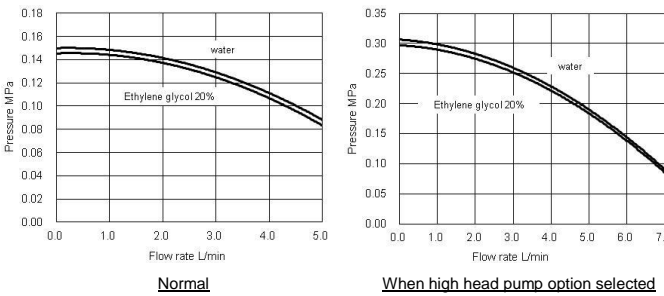

3 Specifications Continued

3.4 Connector Specifications

Description	No.	Signal	Style and Part No.	
Power supply connector (IEC60320,C14)		HECR002 HECR004 HECR006 HECR008	HECR010	
	N	AC100 to 240V	AC200 to 240V	
	L	AC100 to 240V	AC200 to 240V	
	E	PE		
Communication connector Note: Always use shielded cable connected to this connector.		RS-232C	RS-485	
	1	Unused	BUS +	
	2	RXD (RD)	Unused	
	3	TXD (SD)	Unused	
	4	Unused	Unused	
	5	SG	SG	
	6-8	Unused	Unused	
	9	Unused	BUS -	
	Signal· External temperature sensor connector Note: Always use shielded cable connected to this connector.	1-2	Unused	
		3-5	PT-RTD	
6		Output Cutoff Alarm a contact (OPEN During Alarm)		
7		Output Cutoff Alarm Common		
8		Output Cutoff Alarm b contact (CLOSE During Alarm)		
9		Temperature Alarm a contact (OPEN During Alarm)		
10		Temperature Alarm Common		
11		Temperature Alarm b contact (CLOSE During Alarm)		
12-14		Unused		
15		FG		

3.5 Model number of product

The product can be ordered with the model number configured as shown below.

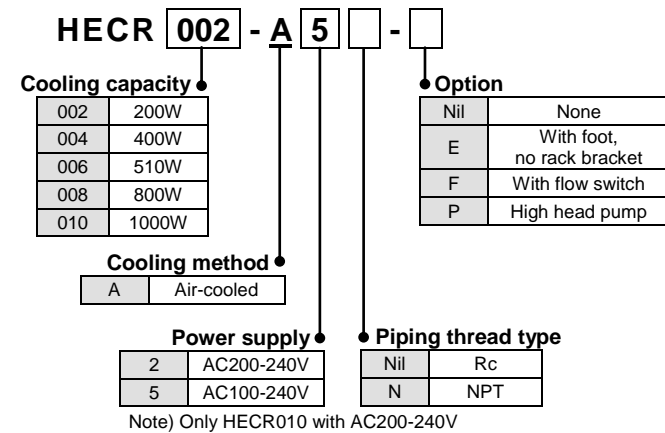

3.6 Product Serial Number Code

The production serial number code printed on the label indicates the year and month of production as per the following table:

Year	2015	2016	2017	...	2021	2022	2023	...				
	T	U	V	...	Z	A	B	...				
Month	Jan	Feb	Mar	Apr	May	Jun	Jul	Aug	Sep	Oct	Nov	Dec
	o To	P TP	Q TQ	R TR	S TS	T TT	U TU	V TV	W TW	X TX	y Ty	Z Tz
	Uo	UP	UQ	UR	US	UT	UU	UV	UW	UX	Uy	UZ
	Vo	VP	VQ	VR	VS	VT	VU	VV	VW	VX	Vy	VZ

	Zo	ZP	ZQ	ZR	ZS	ZT	ZU	ZV	ZW	ZX	Zy	ZZ
	Ao	AP	AQ	AR	AS	AT	AU	AV	AW	AX	Ay	AZ
	Bo	BP	BQ	BR	BS	BT	BU	BV	BW	BX	By	BZ

4 Special Features

- Auto tuning
 - This function sets the values necessary for the control system such as PID (proportional band, integral time, derivative time and ratio of cooling/heating gain) automatically.
 - If the controlled temperature fluctuates constantly after reaching the target temperature, perform auto tuning. Controller calculates optimum control PID and set automatically. Auto tuning may require time depending on the conditions.
 - 1) Select "2" in control operation.
 - 2) Pressing [AT] key to light "AT" indicator and start auto tuning.
 - 3) Pressing [AT] key stops auto tuning. ("AT" indicator turns off)
 - 4) "AT" indicator turns off when auto tuning is complete. If not completed after 20min. [ERR19] (AT abnormal) occurs.
- Offset function
 - This function controls the temperature slide by an offset value from set point temperature. When the circulating fluid travels to the target object, a certain deviation occurs between the temperature just before the object and the set temperature of the product due to the influence of ambient temperature on the piping. In this case, if the deviation is input as the offset value, the temperature of the circulating fluid just before the object can match with the setting value. Internal sensor value for the alarm does not include the offset value. For example, if -0.15 °C is set here, the actual reference temperature for control is lower than the indicated SV by 0.15 °C. Internal sensor value for the alarm does not include the offset value.
- Learning control function
 - This function lets the product measure the temperature of circulating fluid flowing before temperature target object by an external temperature sensor and adjusts the offset function automatically to the set value at a certain sampling interval. The external temperature sensor needs to be prepared separately by the customer.
 - 1) Install an external temperature sensor to the target object.
 - 2) Select "3" in control operation.
 - 3) Thermo-con controls the external sensor value to the set point.
 - 4) When the temperature is not stable, then set the sampling interval larger.

- External tuning control function
 - This function makes the temperature of circulating fluid consistent to the external (ambient) temperature all times. This function lets the product measure the temperature from a temperature sensor mounted in the customer preferred location, then it adjust the temperature of the fluid automatically to the temperature detected by the sensor. The separate temperature sensor needs to be prepared separately by the customer.
 - 1) Install an external temperature sensor to the room.
 - 2) Select "4" in control operation.
 - 3) Thermo-con controls the fluid temperature to the ambient temperature.
 - 4) When the temperature is not stable, then set the sampling interval larger.
- Temperature sensor fine control function
 - This is a function to finely control the measurement temperature of the control sensor within the range of -9.99 to 9.99 °C separate from offset function. Control sensor can be corrected by inputting difference (calibration value) between temperature of standard and that of control sensor. For example, if -0.15 °C is set here, the actual reference temperature for control is lower than the indicated SV by 0.15 °C.
 - Internal sensor value for alarm = Internal sensor value - Fine control value
- Setting value memory function
 - Even if the power is turned off the set values are saved and will be restored at power on.
- Upper / Lower temperature limit alarm function
 - This function raises an alarm when temperature of the circulating fluid is out of allowable upper and lower range. When the alarm is raised, WRN is indicated on LCD. If circulating fluid temperature returns to within allowable upper/ lower range, this alarm is automatically cancelled. The allowable upper and lower range of temperature can be set between 0.1 and 10 °C.
- Output shut off alarm function
 - The product has a self-check function that can detect faults with the product and interrupts the output to the thermo modules, stopping operation (However, operation continues with ERR 15 and ERR 18). This function gives an alarm if a critical error happens, the display shows ERR and an alarm number. At the same time, the warning output connector gives an output through a relay contact. This warning cannot be removed unless the power is cycled. When the power is being cycled leave at least 3 seconds between turning the power off and turning the power back on.

4 Special Features Continued

- Fan speed control (HECR004,HECR006,HECR008,HECR010)
 - Fan speed is controlled automatically in accordance with the heat load.

5 Installation

5.1 Installation



- Pay special attention to the safety of all personnel when installing and transporting the product.
- Do not install the product unless the safety instructions have been read and understood.
- The product is heavy, be careful when installing or moving the product.
- Always transport the product using both handles.
- Leakage from the product may damage peripheral equipment. Install a drain pan under the product to capture leakage. Furthermore, mount devices like a leak sensor on the installed drain pan to detect leakage so that it can alert operators around the area.
- Install the product above 0.6m from the floor.

5.2 Environment



- Do not use in an environment where the product is directly exposed to water, oil, corrosive gases, chemicals, salt water or steam.
- The product should be installed upright on a stable base.
- Do not install the product in a location where the air inlet and air outlet vents are blocked. Also do not use the product in a sealed enclosure.
- Do not use in an explosive atmosphere.
- Do not mount the product in a location where it can be exposed to prolonged sunlight. Use a protective cover.
- Do not mount the product in a location where it is subject to strong vibrations and/or shock. Check the product specifications.
- Do not use the product where it can be exposed to strong electrical or magnetic emissions.
- Do not mount the product in a location where it is exposed to noise sources (such as discharging equipment, large relay and thyristor).

- Do not mount the product in a location with an altitude of more than 1000 meters.
- Do not mount the product where it is exposed to materials such as silicone, which may generate harmful gas.
- Install the product in a location where the ambient temperature range is between 10 to 35°C and the relative humidity range is between 35 to 80%. No dew condensation is allowed on the unit.
- Do not mount the product in a location exposed to radiant heat.

5.3 Mounting

- When mounting the product to a cabinet, use a design which shall hold the weight at the bottom. Ensure safety with transportation test if the product is to be installed on a transportation device such as a trailer.
- Mount the product using the fixing holes in the front of the product. Use M5,M6 screws (bolts) or equivalent to the fix the product.



- Be sure to correctly tighten all screws to the required torque. (M5:3.0Nm, M6:5.2Nm)

5.4 Piping

- Ensure that the power source and the power supply of the product is turned off (or the power plug must come off)
- Ensure the flow rate of the circulating fluid is as high as possible to maintain the temperature stability. Therefore, the length of the external piping should be minimized and internal diameter should be as large as possible. Piping must have sufficient strength for the maximum discharge pressure of the circulating circuit.
- Likewise, if a tube is bent or multiple elbow fittings are used, the piping resistance will increase and the flow rate will decrease. If the flow rate falls, the temperature stability will decrease.
- If installing a tank externally, only a sealed tank should be used. Do not use an open tank.

5 Installation Continued

Caution

- Ensure that the INLET and OUTLET for circulating fluid is connected correctly. If any valves are used ensure that they do not restrict the flow, otherwise low flow may cause an alarm.
- When installing piping or fittings, ensure sealant material does not enter inside the port. When using seal tape, leave 1.5 to 2 threads exposed on the end of the pipe/fitting.
- Be sure to correctly tighten the fitting fittings to the required torque (Rc1/4:12 to 14 N·m, Rc3/8:15 to 20N·m).

5.5 Wiring

- Ensure that the power source and the power supply of the product is turned off before connecting the various connectors and power supply cable.
- Supply disconnecting device according to IEC60974-1 and IEC60947-3 for the product must be provided in the end system.
- Do not install the disconnecting device in the place where the operation is difficult. And also the switch of the disconnecting device must comply with the direction of the switch specified by IEC60447.
- Preparation and wiring of power supply cable
 - Strip the sheath from both ends of the cable.
 - Disassemble the power supply connector. Crimp one end of the cable to L, N, E inside of the connector, then reassemble the power supply connector.
 - Connect the other end of the cable to a plug or terminals (e.g. crimped terminal).

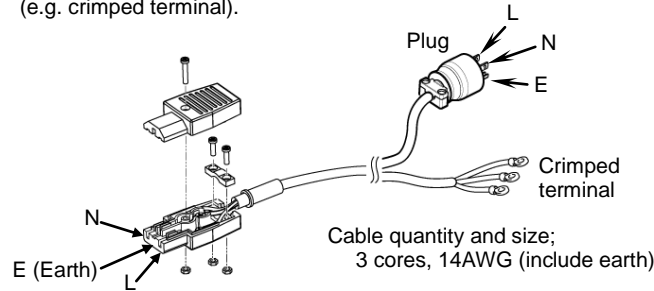

- Ensure that there is enough space between the power supply cable and the communication cable of the product and power cables of other equipment.
- Ensure the power supply and ground connections are made correctly.
- Be sure to provide the grounding. The PE line of the power supply cable is available for grounding. Do not connect the ground in common with the ones for equipment that generates strong electromagnetic noise or high frequency.
- When an external temperature sensor is connected, connect the sensor with a shield cable. Use a platinum resistant temperature sensor (Pt100ohm, 3-wiring type, class A, 1mA).

- Connect the host to this unit with a twisted pair shield cable when applying communication function or external sensor and alarm output function.
- When using the Communication connector and Signal/External temperature sensor, connect the circuit separated from the mains circuit by reinforced insulation.
- Ensure that external instruments connecting to this product provide the enclosure complied with UL61010-1 and use the cable which provide flame resistance (over VW-1).

5.6 Filling the product

- Ensure that the power source and the power supply of the product is turned off (or the power plug must come off).
- Remove the reservoir cap. (When setting the product again, confirm the level of fluid does not exceed the "H" mark)
- If using Ethylene Glycol, refer to the suppliers Material Safety Data Sheet (MSDS) and wear Personal Protective Equipment (PPE) as appropriate.
- Fill the circulating fluid into the reservoir. Stop filling once the level of fluid reaches the "H" mark.
- Turn on the power switch to fill the piping with the fluid.
- When the piping is filled with the circulating fluid, the level of the reservoir decreases and low fluid level alarm (ERR20) arises accordingly. Then, turn off the power supply once again.
- Repeat the step from 4 to 6 until ERR20 alarm doesn't appear anymore.
- Then, replace the cap on the reservoir and tighten it securely.
- Keep the fluid level between H and L of the level indicator.

5 Installation Continued

Danger

- Never touch the power switch with wet hands to avoid electrical shock.

Caution

- Do not touch the surface when the set temperature is high. Temperature of the tank and the chassis near the tank could be high.
- Fluid other than water or Ethylene Glycol (up to 20%) should not be used as circulating fluid. Using such fluid may lead to leakage or damage of the pump.
- Operation of the pump with a large amount of air left in the piping for prolonged period may damage the pump. Remove air from piping before starting operation.
- If the power switch is turned on without circulating fluid, the pump could be damaged.
- Take care not to spill water over the product when supplying water to the reservoir. When a spill is made, wipe it off immediately and only supply power after it has dried. If this procedure is neglected, it may cause damage to the product.
- If a fluid with low conductivity such as DI water is used as circulating fluid, it can cause static electricity due to friction and damage the product. Take measures to minimize the static electricity from circulating fluid.
- If the product is operating for a long time with large temperature fluctuations after reaching the set temperature, the product may be damaged. Please set the PID values by using the auto-tuning function.

6 Operation

6.1 Power Up

When power is turned on, the software version is indicated on display panel for approx. 1 second.

6.2 Operation

The product begins operation immediately after the power is turned on. The pump and heat exchanger will be running and the product will begin temperature control.

The display can show the following information during operation.

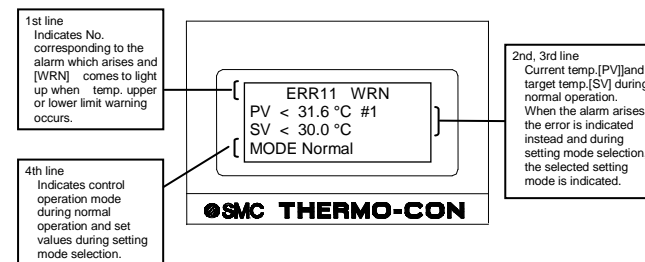

6.3 Settings

Three different levels of settings are available depending on the content, which needs to be set.

- Level 1: Used in normal operation e.g. setting of target temperature and offset.
- Level 2: Used at maintenance and initial setting for setting of controller/PID.
- Level 3: Used at initial setting for the communication function.

The key functions are as follows:

[SEL]: Used to show the item that needs to be changed in selected mode level.

[▽△]: Used to change the value of the item selected.

[RET]: Used to fix the value changed by [▽△] key.

Press again to return to current temperature indication.

[AT]: Used to start auto tuning in auto tuning mode

(This function works when the control operation mode is 2 in level setting 1)

When pressed during auto tuning, the auto tuning is stopped.

- When no input is made within 1 minute regardless of setting mode, the display returns to the current temperature indication.
- The data input is written to FRAM and memorized after the power supply is turned off.
- To return all of the setting values to default: Turn on the power supply while pressing [SEL] and [RET] keys.

6 Operation Continued

6.3.1 Level 1—Settings

No.	Modes	Setting contents	Setting range (Min. increment)	Default
1	Target Temp. (No indication on display)	Sets target temp. for control.	10.0 to 60.0°C (0.1°C)	25.0
2	Control Operation	Selects control operation mode from those shown below. 0: Pump stop (No control) 1: Normal operation 2: AT(auto tuning) 3: Learn (learning control) 4: External (external tune control) 5: SeriRem (Serial remote) 5: Serial remote is displayed when choose the Modbus communication.	0,1,2,3,4,5	1
3	External Sensor Sampling Cycle	Sets sampling cycle for learning control or external tune control.	10 to 999sec (1sec)	60
4	Offset Value	Indicates the offset value of the circulating fluid temperature used as reference value by the controller (SV + Offset).	-9.99 to 9.99°C (0.01°C)	0.00
5	Allowable Upper Temp. Range	Sets upper limit of temp. range which causes a warning to occur.	0.1 to 10.0°C (0.1°C)	1.5
6	Allowable Lower Temp. Range	Sets lower limit of temp. range which causes a warning to occur.	0.1 to 10.0°C (0.1°C)	1.5
7	High Temp. Cutoff	Sets upper limit of temp. measured by the internal temp. sensor and stops operation of the product.	11.0 to 70.0°C (0.1°C)	70.0
8	Low Temp. Cutoff	Sets lower limit of temp. measured by the internal temp. sensor and stops operation of the product.	0.0 to 59.0°C (0.1°C)	0.0

6.3.2 Level 2—Settings

No.	Modes	Setting contents	Setting range (Min. increment)	Default
1	Fine Control of Internal Sensor	Sets the fine adjusting value to calibrate the internal temp. sensor	-9.99 to 9.99°C (0.01°C)	0.00
2	Fine Control of External Sensor	Sets the fine adjusting value to calibrate the external temp. sensor available optionally.	-9.99 to 9.99°C (0.01°C)	0.00
3	PB Range	Sets PB (Proportional Band) range used for PID control.	0.3 to 9.9°C (0.1°C)	6.0
4	I Constant	Sets integral time used for PID control.	1 to 999sec (1sec)	18

5	D Constant	Sets differential time used for PID control. When 0 is set, differential operation is not made.	0.0 to 99.9sec (0.1sec)	0.0
6	Heating/Cooling Ratio	Sets output ratio of cooling to heating to compensate difference of gain between them.	10 to 999% (1%)	300
7	Overload Judging Temp. Rang	Sets the temp. range for judgment of overload (accompanying abnormal output alarm ERR15).	0.1 to 9.9°C (0.1sec)	0.2
8	Overload Judging Time	Sets time for judgment of overload (accompanying abnormal output alarm ERR15). When 0 is set, the alarm doesn't arise.	0 to 99min (1min)	10
9	Output Ratio	Shows output ratio of thermo module by 1%. The prefix symbol "-" stands for cooling and no prefix stands for heating.	-100 to 100% (1%)	-
10	Upper/Lower Temp. Alarm Sequence	Determines whether or not temp. upper/lower limit alarm is output when power is turned on. On : Output Off : Not output	On, Off	Off

6.3.3 Level 3—Settings

No.	Modes	Setting contents	Setting range	Default
1	Serial communications	RS-232C / RS-485	RS-232C, RS-485	RS-232C
2	Termination resistor	Sets the termination resistor (120 Ω) for RS-485 communication	On, Off	Off
3	Communication protocol	Set the Communication protocol. SMC CMD:same as existing HEC communication Modbus:Modbus communication	SMC CMD Modbus	SMC CMD
4	Unit Number	Sets the unit No. used. This is applicable only when multiple Thermo-cons are used. (Unit number 1 to F is valid when used the Modbus communication)	0 to F (Hex decimal)	0
5	Baud Rate	Sets baud rate for communication.	600, 1200, 2400, 4800, 9600, 19200b/s	1200
6	Parity Bit	Sets parity bit for communication. None : No parity Odd : Odd Even : Even	None, Odd, Even	None
7	Data Length	Sets data length for communication.	7Bits, 8Bits	8
8	Stop Bit	Sets stop bit for communication.	1Bit, 2Bits	1

7 Outline Dimensions (mm)

HECR002

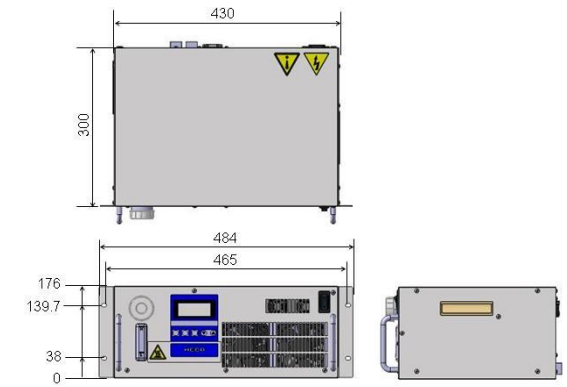

HECR002-A5-E(option)

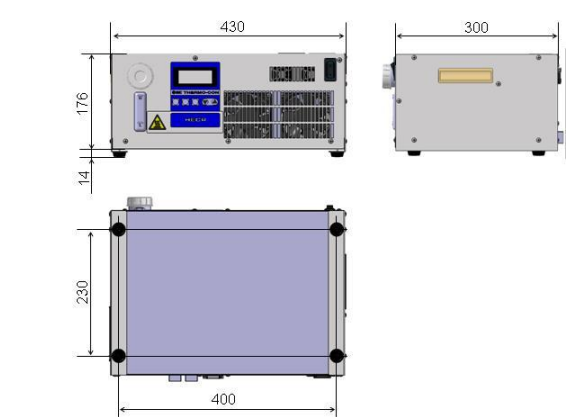

HECR004

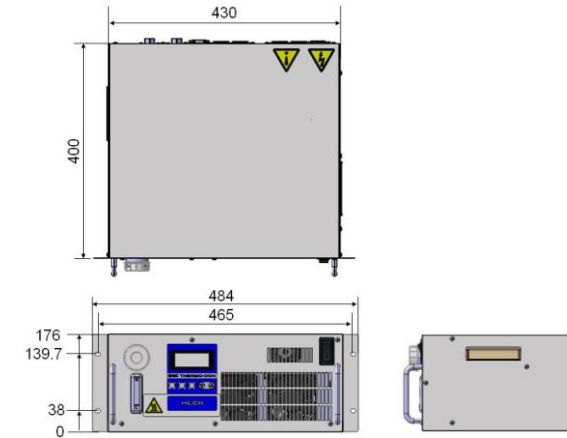

HECR004-A5-E(option)

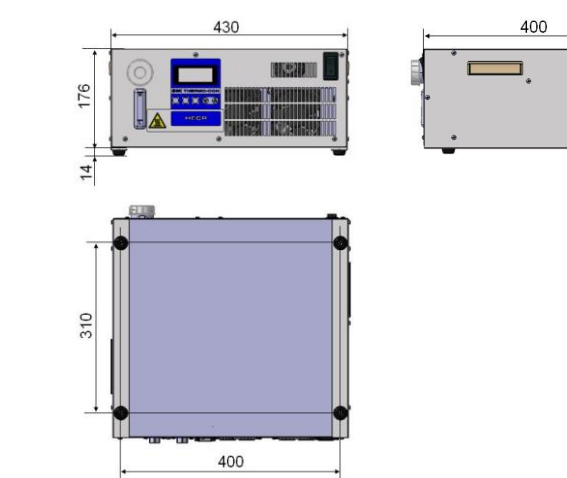

7 Outline Dimensions (mm) Continued

HECR006

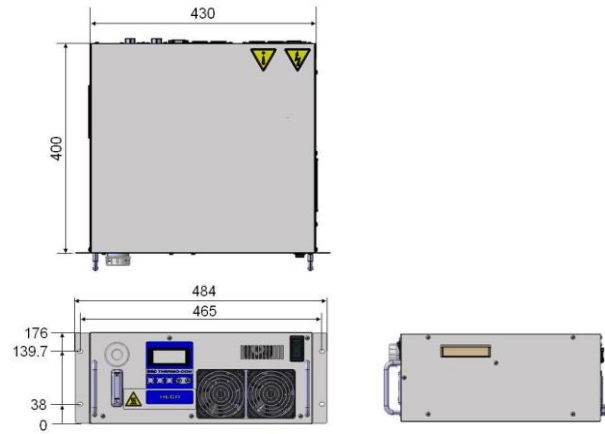

HECR006-A5-E(option)

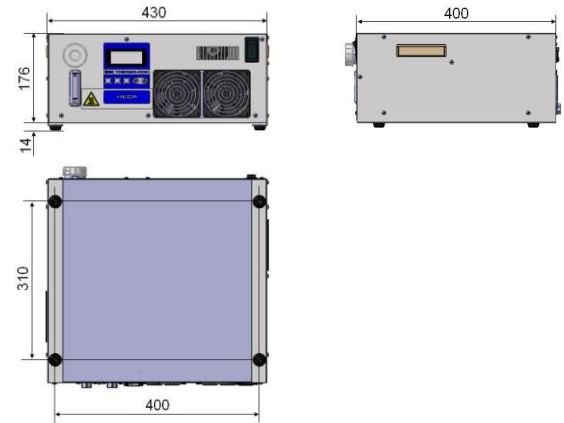

HECR008

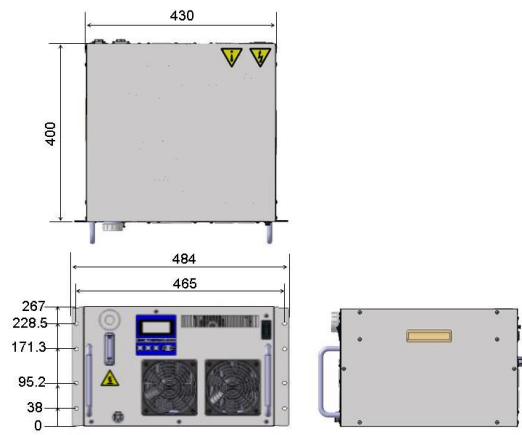

HECR008-A5-E(option)

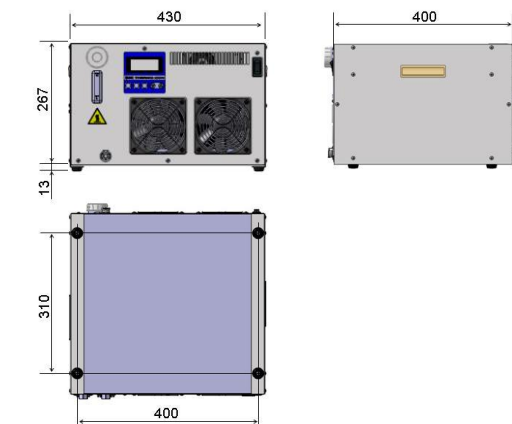

7 Outline Dimensions (mm) Continued

HECR010

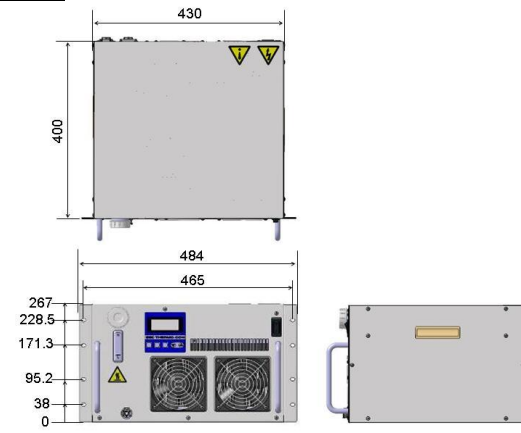

HECR010-A2-E(option)

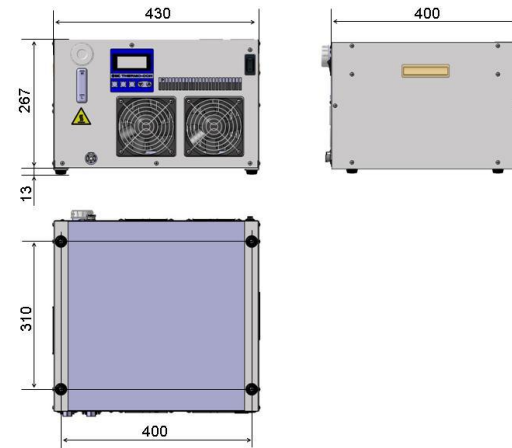

8 Key Parts

HECR002 / HECR004 / HECR006

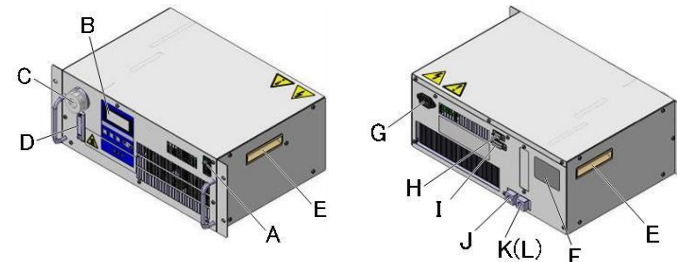

HECR008 / HECR010

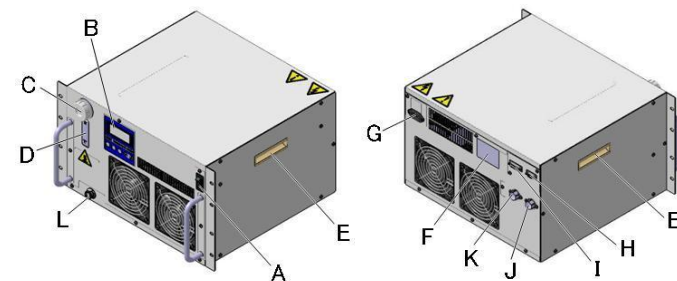

A	Power switch	G	Power supply connector
B	Display/Operation panel	H	Communication connector
C	Reservoir Cap	I	External sensor/Alarm output connector
D	Level gauge	J	Circulating fluid OUT
E	Handle	K	Circulating fluid IN
F	Model No. label	L	Dain port

9 Maintenance

9.1 Daily Check

- 1) Indication of display panel: Check temperature condition and confirm whether or not an alarm has occurred.
- 2) Confirm that the heat sink and panel are free from dust. A large amount of dust may impair the performance.
- 3) Confirm there is no leakage of circulating fluid and check the condition of the piping (e.g. no tight bends or crushed pipes).
- 4) Confirm there is no abnormal sound, smell or heating from the product.

Caution

- When cleaning the panel or heat sink use a vacuum cleaner to remove the dust. Do not use water or steam since it leads to rusting of the frame.

9.2 General Maintenance

Replace the circulating fluid regularly to avoid any problems due to algae or contamination.

<Drain circulating fluid>

HECR002 / HECR004 / HECR006

1. Drain circulating fluid from the Fluid IN.
Loosen the reservoir cap to help draining. (Do not remove the cap)
2. To drain from the piping, blow air (0.1MPa, about 1 minute) from Fluid OUT to Fluid IN. Close the reservoir cap while blowing.

HECR008 / HECR010

1. Drain circulating fluid from the Drain port.
Loosen the reservoir cap to help draining. (Do not remove the cap)
2. To drain from the piping, blow air (0.1MPa, about 1 minute) from Fluid OUT to Drain port. Close the reservoir cap and Fluid IN while blowing.

Caution

- The repair and maintenance services of this unit are performed only at SMC factory. SMC does not provide on-site repair or maintenance service in a national or overseas situation.
- It is recommended to prepare spare units to minimize downtime due to those repair and maintenance services.
- Drain the fluid from the product when it is returned for the repair and maintenance service. If the fluid is left inside, an accident and damage can result during transportation.

- Do not make any modification to the product.
- Do not disassemble the product, unless required by installation instructions.
- If fluid other than water is used, wash the circulating fluid circuit with water or DI water before returning the product to SMC. Products that have not been washed may not be accepted at the factory.

10 Troubleshooting

10.1 How to reset the alarm

Code	Description	Manner of reset
ERR01	System error 1	Restart the power supply. In the case the alarm can't be reset by above manner, repair is required.
ERR02	System error 2	Restart the power supply. In the case the alarm can't be reset by above manner, repair is required.
ERR03	Back-up data error	Initialization of FRAM or stop and restart of power supply. In the case the alarm can't be reset by above manner, repair is required.
WRN	Temp. upper/lower limit alarm	The unit continues controlling and recovers normal condition at any time.
Others		Remove a possible cause and restart. In the case the alarm can't be reset by above manner, repair is required.

10.2 Product alarm codes

Code	Description	Operation status	Reason for alarm setting	Cause / Measure
WRN	Temp. upper/lower limit	Continue	Fluid temperature is out of limit range.	Product is reaching target temperature. Wait for the temperature to stabilize, then the WRN should disappear.
ERR01	System error 1	Stop	The wire inside the Thermo-con was broken due to vibration during transport.	In the case the alarm can't be reset by above manner, repair is required.
ERR02	System error 2	Stop	The FRAM data was destroyed by high-level noise.	Move the product to an environment with little noise, turn ON the power supply. If there is no alarm, it was caused by noise. Please consult with SMC.
ERR03	Back-up data error	Stop	The memory data was destroyed by high-level noise.	Move the product to an environment with little noise, turn ON the power supply. If there is no alarm, it was caused by noise. Please consult with SMC.

10 Troubleshooting Continued

Code	Description	Operation status	Reason for alarm setting	Cause / Measure
ERR11	DC power supply failure	Stop	DC output voltage of product is reduced.	Check the power voltage. HECR002: 100 to 240VAC HECR004: 100 to 240VAC HECR006: 100 to 240VAC HECR008: 100 to 240VAC HECR010: 200 to 240VAC
			The fans at the power supply stops.	Remove foreign matters which might stop the fan.
ERR12	Internal temp. sensor High temp. failure	Stop	Internal temp. sensor value exceeds the high temp. cutoff temperature.	Check the set value for high temp. cutoff temperature and confirm the temperature really reaches this value.
			Flow rate of circulating fluid is zero.	If the flow rate of the circulating fluid is zero, the temperature of circulating fluid can't be detected and might increase. Confirm the flow of circulating fluid is not stopped by valves etc.
ERR13	Internal temp. sensor Low temp. failure	Stop	Internal temp. sensor value is lower than low temp. cutoff temperature.	Check the set value for low temp. cutoff temp. and confirm the temperature really reaches this value.
			Flow rate of circulating fluid is zero.	If the flow rate of the circulating fluid is zero, the temperature of circulating fluid can't be detected and might decrease. Confirm the flow of circulating fluid is not stopped by valves etc.
ERR14	Thermostat alarm	Stop	Flow rate is zero.	If flow rate of circulating fluid is zero, the temperature of circulating fluid cannot be measured and the temperature of heat exchanger may increase. Ensure the circulating fluid is allowed to flow.
			The pump breaks.	
ERR15	Abnormal output alarm	Continue	Cooling or heating capacity overload.	No temperature decrease when 100% cooling output. No temperature increase when 100% heating output.
			Volume of circulating fluid is too large.	If the volume of circulating fluid system is too large, the change of temperature takes a long time. In this case, change overload judging time setting to avoid this alarm. (Refer to 6.3.2)
ERR16	Low circulating flow rate alarm (Option)	Stop	The flow rate of the circulating fluid is 1 L/min. or less	Investigate why the flow rate of the circulating fluid is low and take countermeasures.

ERR17	Internal temp. sensor disconnection alarm	Stop	High level noise entered the temp. sensor line.	Check whether unstable temperature is caused by noise. Please consult SMC if it is caused by noise.
ERR18	External temp. sensor disconnection alarm	Continue	The external temp. sensor is not mounted.	For learning control or external tune control, be sure to mount the external temp. sensor.
ERR19	Abnormal auto tuning alarm	Stop	Capacity of circulating fluid is too large.	Adjust PID value (proportional band, integral time and derivative time) of setting mode Level 2 by hand.
			Overloaded during auto tuning mode	Avoid overload.
ERR20	Low fluid level alarm	Stop	Fluid level of tank is not enough.	Refill tank with fluid.
			Fluid is leaking.	Check all fluid connections connected with the product.
Temperature rises and falls +/-1 to 2 °C gradually about the set point temperature.			Flow rate of circulating fluid is low.	Keep the flow rate 0.5L/min(HECR002)/1L/min(HECR004,HECR006,H ECR008,HECR010) or more.
			PID parameters are set incorrectly.	If the temperature cannot be stable at default value, perform auto tuning.

11 Declaration of Conformity

Below is a sample Declaration of Conformity(DoC) used for this product. An actual DoC will be supplied with each product.

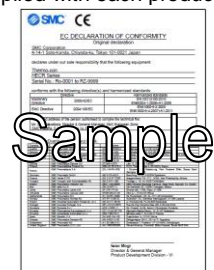

SMC Corporation

URL : [http:// www.smcworld.com](http://www.smcworld.com) (Global) [http// www.smceu.com](http:// www.smceu.com) (Europe)

Specifications are subject to change without prior notice from the manufacturer.

© 2015 SMC Corporation All Rights Reserved.