



# Operation Manual

## Communication function

### Thermo-chiller

**Air-Cooled  
refrigerated type**

- HRR012-A-10-\**
- HRR018-A-10-\**
- HRR010-A-20-\**
- HRR012-A-20-\**
- HRR018-A-20-\**
- HRR024-A-20-\**
- HRR030-A-20-\**
- HRR050-A-20-\**

**Water-Cooled  
refrigerated type**

- HRR012-W-10-\**
- HRR018-W-10-\**
- HRR010-W-20-\**
- HRR012-W-20-\**
- HRR018-W-20-\**
- HRR024-W-20-\**
- HRR030-W-20-\**
- HRR050-W-20-\**

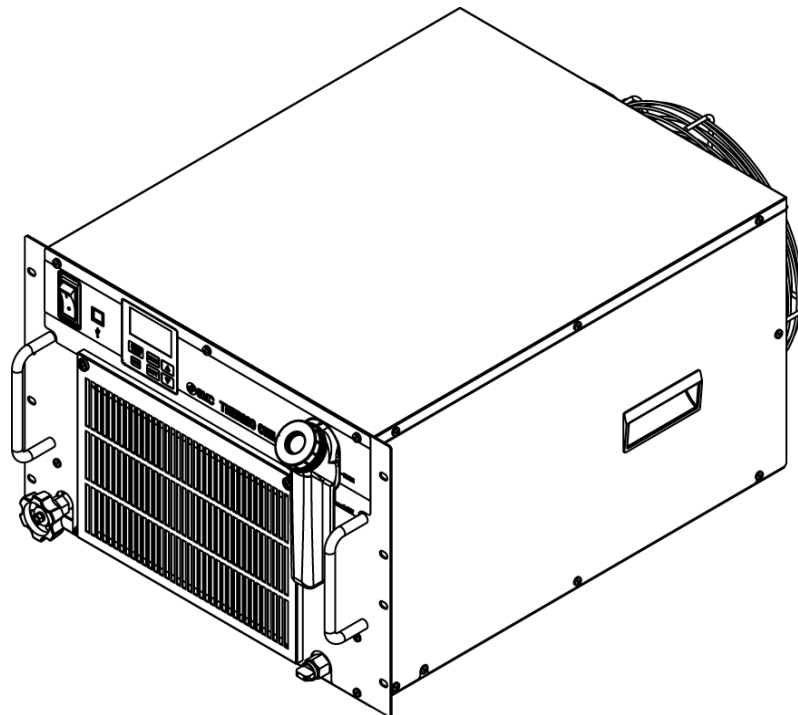

**Keep this manual available whenever necessary**

## To Users,

Thank you for purchasing SMC's Thermo chiller (hereinafter referred to as the "product").

For safety and long life of the product, be sure to read this operation manual (hereinafter referred to as the "manual") and clearly understand the contents.

- Be sure to read and follow all instructions noted with "Warning" or "Caution" in this manual.
- This manual is intended to explain the installation and operation of the product. Only people who understand the basic operation of the product through this manual or who performs installation and operation of or have basic knowledge about industrial machines are allowed to work on the product.
- This manual and other documents attached to the product do not constitute a contract, and will not affect any existing agreements or commitments.
- It is strictly prohibited to copy this manual entirely or partially for the use by the third party without prior permission from SMC.

**Note: This manual is subject to possible change without prior notice.**

# Contents

|                  |   |            |
|------------------|---|------------|
| <b>Chapter 1</b> | <b>Read before using .....</b>                          | <b>1-1</b> |
| 1.1              | Communication mode and operation method.....            | 1-1        |
| 1.2              | Communication port .....                                | 1-3        |
| 1.3              | Key operations .....                                    | 1-4        |
| 1.4              | Parameters.....   | 1-8        |
| <b>Chapter 2</b> | <b>Contact input/output communication .....</b>         | <b>2-1</b> |
| 2.1              | Precautions for communication .....                     | 2-1        |
| 2.1.1            | Precautions wiring communication .....                  | 2-1        |
| 2.1.2            | Precautions after wiring and before communication ..... | 2-1        |
| 2.2              | Communication specification.....                        | 2-2        |
| 2.3              | Connection explanation.....                             | 2-2        |
| 2.4              | Setting and checking .....                              | 2-3        |
| 2.4.1            | Setting and checking.....                               | 2-3        |
| 2.4.2            | Setting and checking.....                               | 2-4        |
| 2.5              | Contact input signal .....                              | 2-12       |
| 2.5.1            | Run/stop·Run·Stop·External switch signal.....           | 2-13       |
| 2.5.2            | Signal of the external switch .....                     | 2-14       |
| 2.6              | Contact output signal.....                              | 2-16       |
| <b>Chapter 3</b> | <b>Serial communication .....</b>                       | <b>3-1</b> |
| 3.1              | Precautions wiring communication .....                  | 3-1        |
| 3.2              | Connected explanation .....                             | 3-1        |
| 3.3              | Communication specification.....                        | 3-2        |
| 3.4              | MODBUS communication function .....                     | 3-3        |
| 3.5              | Precautions for communication .....                     | 3-3        |
| 3.5.1            | Precautions after wiring and before communication ..... | 3-3        |
| 3.5.2            | Precautions for communicating.....                      | 3-3        |
| 3.6              | Setting and checking .....                              | 3-4        |
| 3.6.1            | Setting and checking items .....                        | 3-4        |
| 3.6.2            | Setting and checking.....                               | 3-5        |
| 3.7              | Communication sequence .....                            | 3-7        |
| 3.8              | Message configuration .....                             | 3-8        |
| 3.8.1            | Message frame .....                                     | 3-8        |
| 3.9              | Function codes.....                                     | 3-9        |
| 3.10             | Checksum calculation method.....                        | 3-10       |
| 3.10.1           | LRC(ASCII) .....  | 3-10       |
| 3.10.2           | CRC(RTU).....   | 3-10       |
| 3.11             | Explanation of function codes .....                     | 3-12       |
| 3.11.1           | Function code : 04 Reading multiple registers .....     | 3-12       |
| 3.11.2           | Function code : 06 Writing registers.....               | 3-13       |
| 3.11.3           | Function code : 16 Writing multiple registers .....     | 3-14       |

|                  |  |             |
|------------------|--|-------------|
| 3.11.4           | Function code: 23 Reading/writing multiple registers ..... | 3-15        |
| <b>3.12</b>      | <b>Negative response .....</b>                             | <b>3-16</b> |
| <b>3.13</b>      | <b>Register Map .....</b>                                  | <b>3-18</b> |
| 3.13.1           | Circulating fluid discharge temperature .....              | 3-19        |
| 3.13.2           | Circulating fluid flow rate .....                          | 3-19        |
| 3.13.3           | Circulating fluid discharge pressur .....                  | 3-19        |
| 3.13.4           | Electric conductivity of the circulating fluid .....       | 3-19        |
| 3.13.5           | Status flag.....   | 3-19        |
| 3.13.6           | Alarm flag.....  | 3-20        |
| 3.13.7           | Data instruction information.....                          | 3-21        |
| 3.13.8           | Data display .....   | 3-21        |
| 3.13.9           | Circulating fluid set temperature.....                     | 3-21        |
| 3.13.10          | Operation Start Command.....                               | 3-21        |
| 3.13.11          | Serial remote instruction.....                             | 3-21        |
| 3.13.12          | Data instruction.....                                      | 3-22        |
| <b>Chapter 4</b> | <b>Communication alarm function .....</b>                  | <b>4-1</b>  |
| <b>4.1</b>       | <b>Communication alarm occurs.....</b>                     | <b>4-1</b>  |
| <b>4.2</b>       | <b>Communication alarm reset.....</b>                      | <b>4-2</b>  |
| <b>4.3</b>       | <b>Setting and checking.....</b>                           | <b>4-2</b>  |
| 4.3.1            | Setting and checking items.....                            | 4-2         |
| 4.3.2            | Setting and checking .....                                 | 4-3         |

# Chapter 1 Read before using

The communication of this device consists of contact input/output communication and serial communication.

The serial communication protocol is a MODBUS communication. Depending on the customer's specification, communication can be changed to contact input/output communication or serial communication.

Table 1-1 Communication method

|                                     |                          |   |
|-------------------------------------|--------------------------|---|
| Contact input/output communication. |                          | This product is equipped with a terminal which runs/stops the product by remote control and a terminal which can pick up alarm signals. The terminals can be changed depending on the customer's application. |
| Serial communication                | MODBUS standard protocol | Serial communication (RS-485/RS232C) enables remote control of run/start of the product, temperature setting, and details of product condition and alarm condition can be obtained.                           |

**●If using contact input/output communication, refer to chapter 2.**

**●If using serial communication MODBUS, refer to chapter 3.**

## 1.1 Communication mode and operation method

LOCAL, DIO and SERIAL are available as the communication modes. Table 1.1-1 explains the communication modes. The default setting is LOCAL.

The operation method depends on the communication mode. Table 1.1-2 shows how the communication mode and method of operation are related.

Table 1.1-1 Communication modes.

| Communication mode |        | Explanation   | Setting  | Display              |
|--------------------|--------|---|--|----------------------|
| LOCAL              |        | Run / stop and circulating fluid temperature setting are possible with the operation panel.                         | Select contact input signal function 1 selection to "OFF" (initial setting) / "SW".  | None                 |
| DIO                | REMOTE | Run / stop with contact input, and set circulating fluid temperature on the operation panel.                        | Select contact input signal function 1 selection as "RN.ST" / "RUN".   | RMT Lamp Lighting up |
|                    | LOCAL  | Run / stop with the operation panel or contact input. Set the circulating fluid temperature on the operation panel. | When the operation of the contact input signal function 1 is selected as "MT" in the state of DIO REMOTE, it becomes "DIO LOCAL" | RMT Lamp Lighting up |
| SERIAL             |        | Run / stop and circulating fluid temperature setting are possible with the serial communication                     | When serial remote instruction is valid, this mode is switched.  | RMT Lamp Lighting up |

Table 1.1-2 Communication mode and operation

|  | LOCAL | DIO       |            | SERIAL |
|--|-------|-----------|------------|--------|
|  |       | DIO LOCAL | DIO REMOTE |        |
| Run/Stop control with operation display panel  | ○     | ○         | ×          | ○      |
| Circulating fluid discharge temperature setting control with operation display panel | ○     | ○         | ○          | ×      |
| Except above with operation display panel  | ○     | ○         | ○          | ○      |
| Condition reading with operation display panel                                       | ○     | ○         | ○          | ○      |
| Run/Stop operation by contact input/output communication                             | ×     | ○         | ○          | ×      |
| Condition reading by contact input/output communication                              | ○     | ○         | ○          | ○      |
| Reading of the external switch   | ○     | ○*1       | ○*1        | ○      |
| Run/Stop operation by serial communication.  | ×     | ×         | ×          | ○      |
| Circulating fluid discharge temperature setting control by serial communication.     | ×     | ×         | ×          | ○      |
| Condition reading by serial communication.   | ○     | ○         | ○          | ○      |

\*1 Only one external switch can be installed.

## 1.2 Communication port

The communication port at the back of the product is used for communication. Fig 1.2-1 shows the location of the communication port.

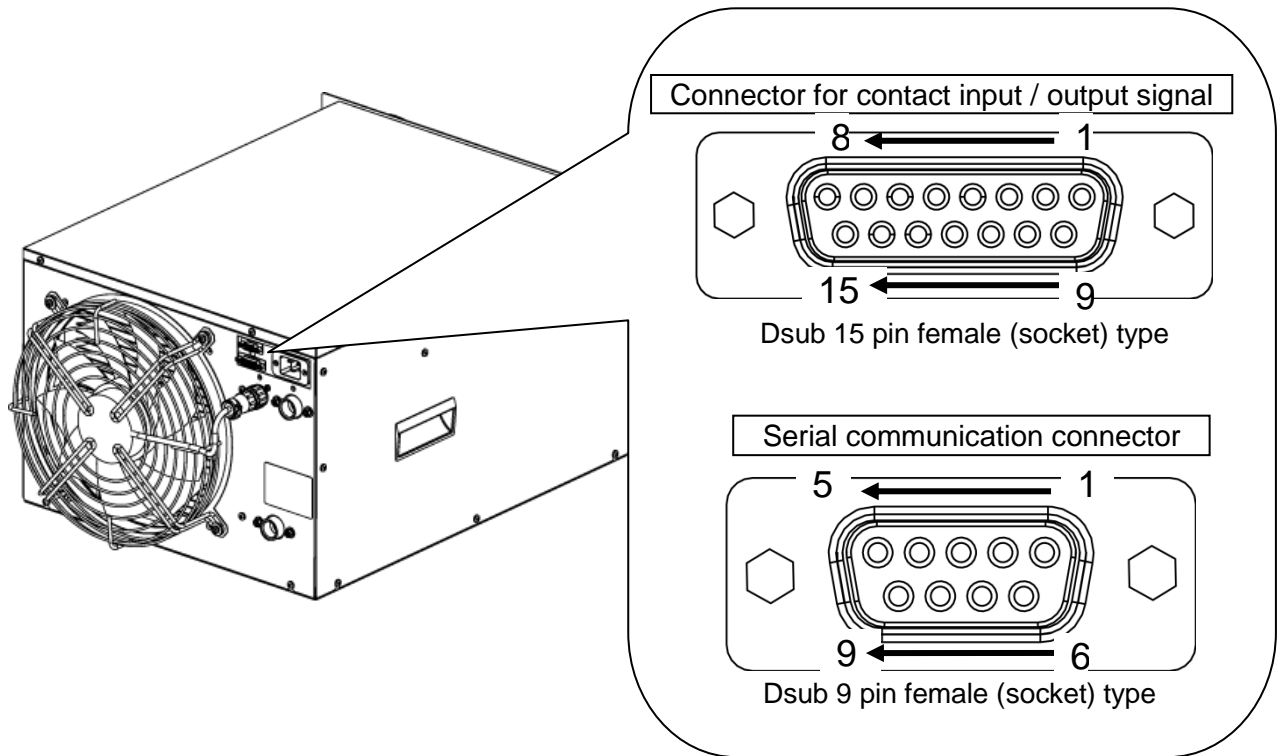

Fig 1.2-1 Communication port

# 1.3 Key operations

Fig 1.3-1 “Key operation(1/4)” and Fig1.3-4 “Key operation(4/4)” show the operation of keys of the thermo-chiller. This manual explains the “Communication setting menu”.

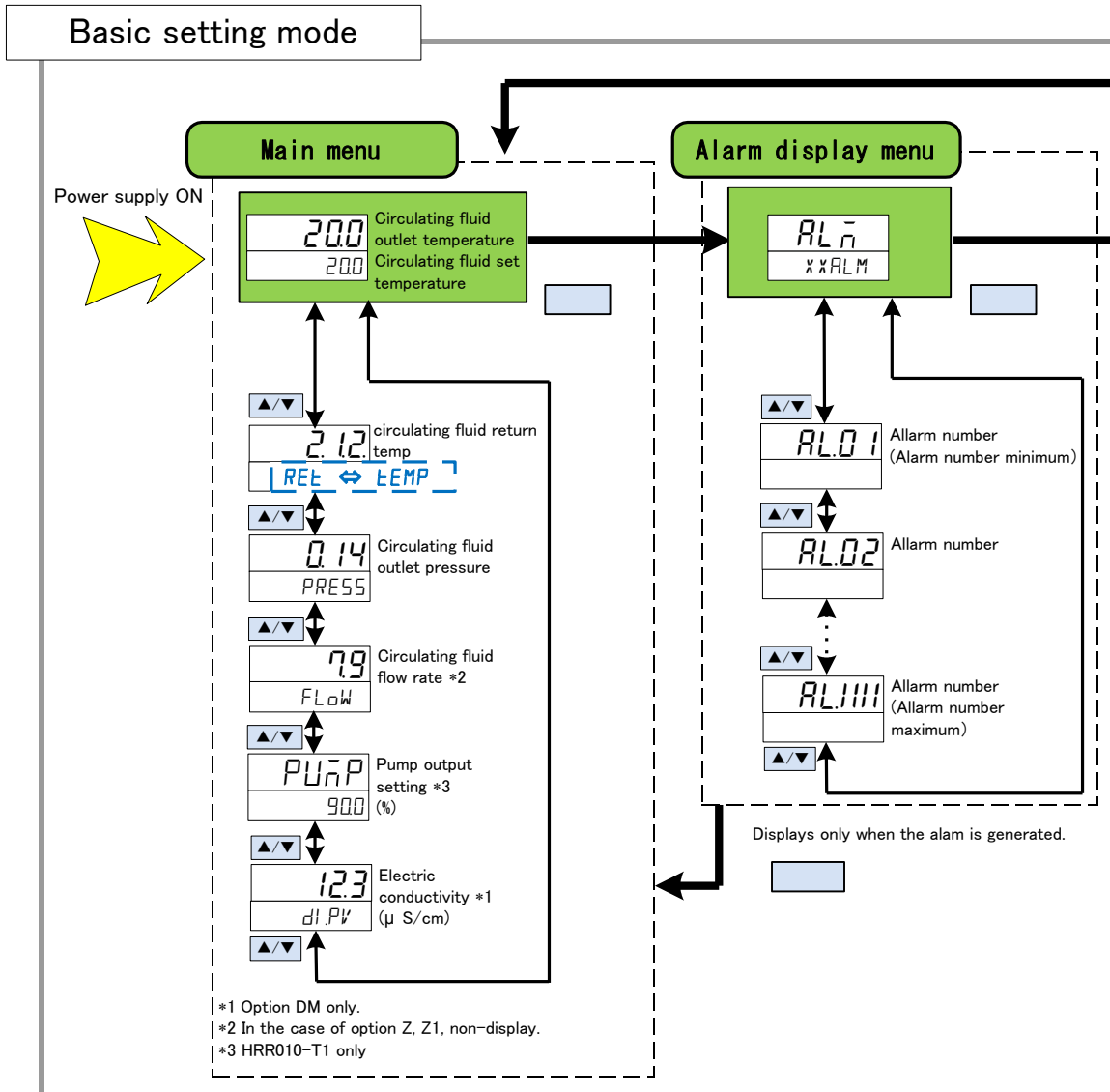

Fig 1.3-1 Key operation (1/4)



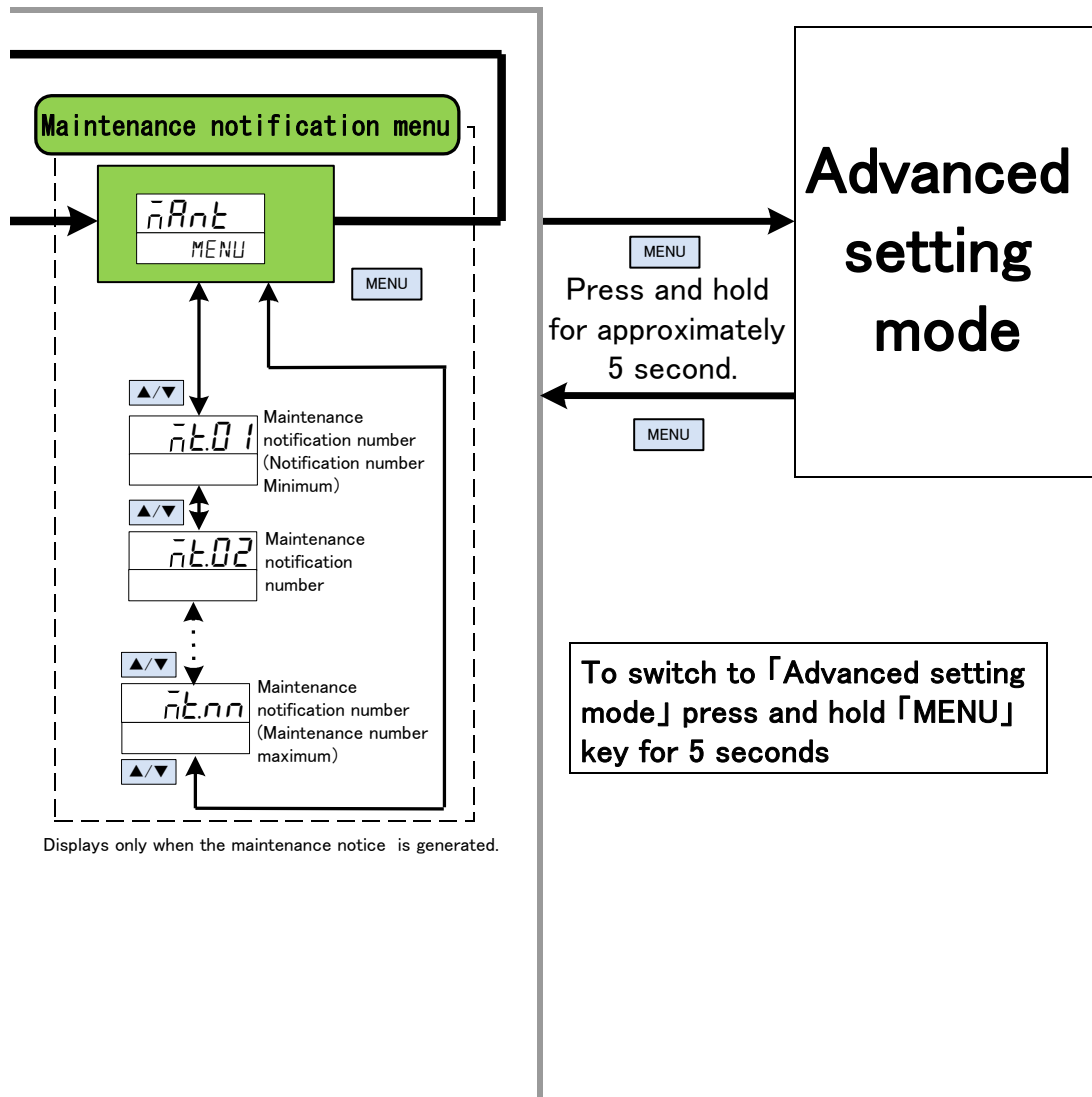

Fig 1.3-2 Key operation (2/4)

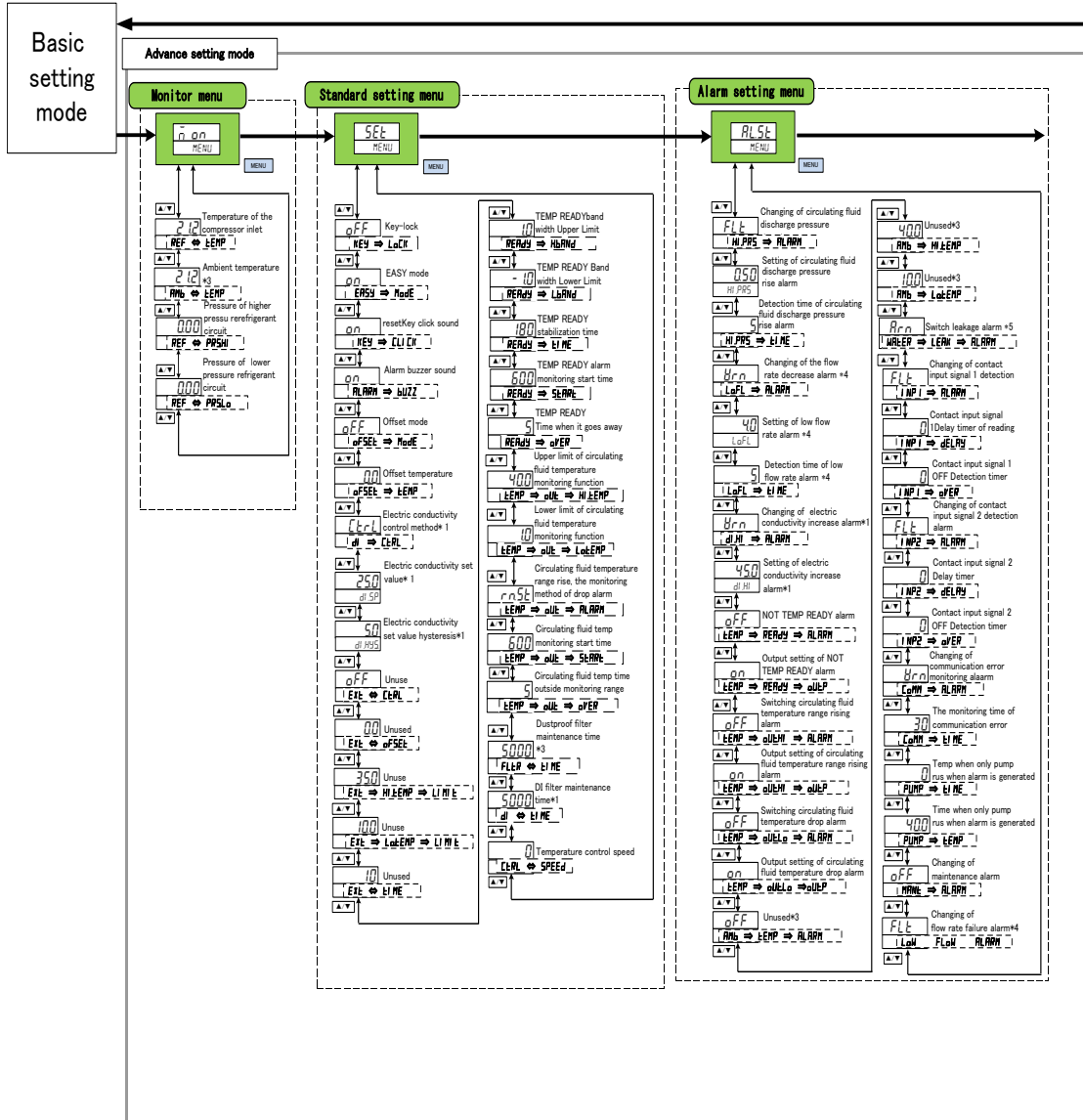
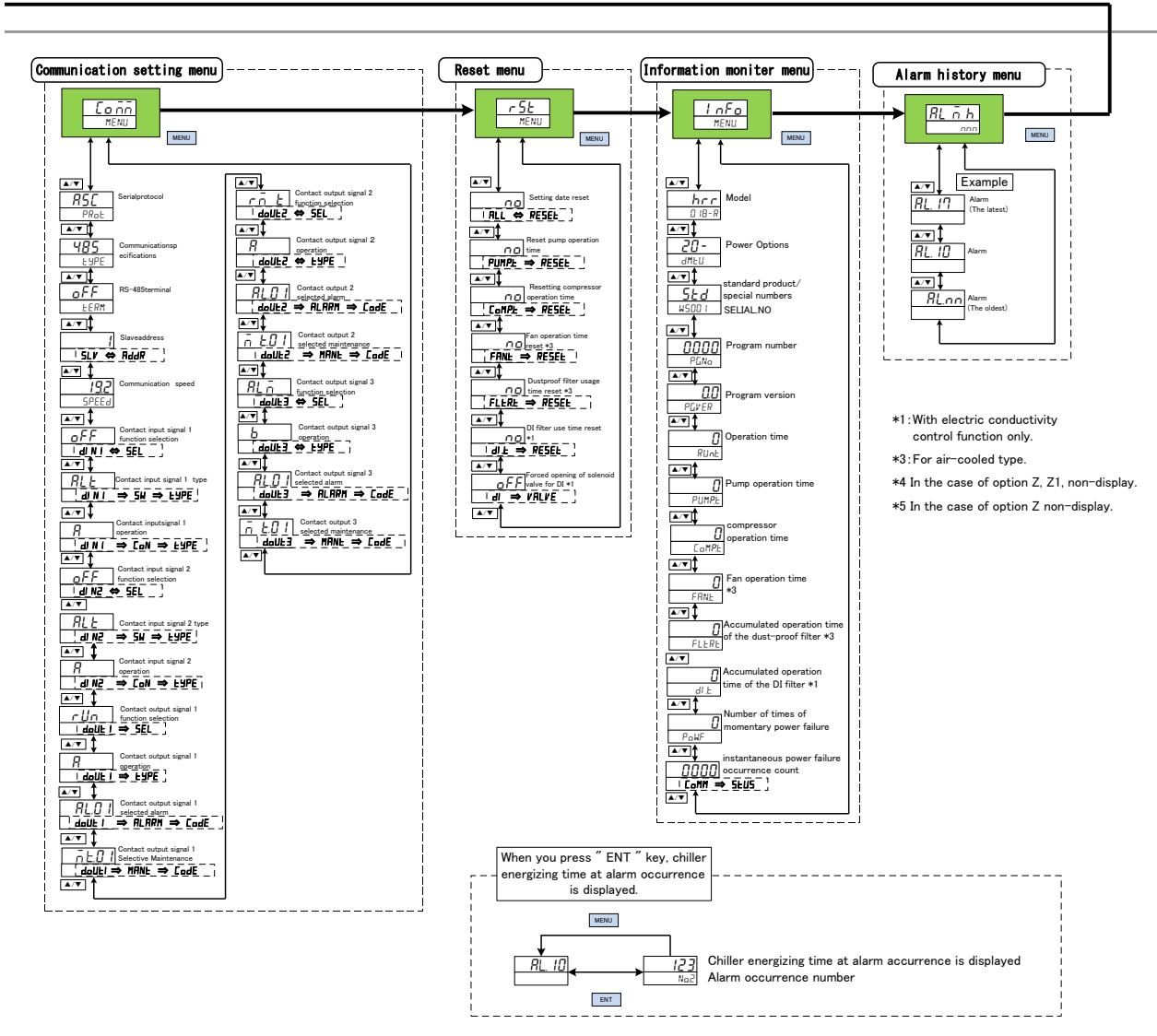

Fig 1.3-3 Key operation (3/4)



- \*1: With electric conductivity control function only.
- \*3: For air-cooled type.
- \*4 In the case of option Z, Z1, non-display.
- \*5 In the case of option Z non-display.

Fig 1.3-4 Key operation (4/4)

## 1.4 Parameters

Table 1.4-1 "Communication setting menu Parameters" explains the parameters of the 「communication setting menu」.

Table 1.4-1 Communication setting menu Parameters

| ScreenNo.    | Item                                | Display unit        |                      |                       | Reference page |
|--------------|-------------------------------------|---------------------|----------------------|-----------------------|----------------|
|              |                                     | Upper stage (White) |                      | Lower stage (Green)   |                |
|              |                                     | Initial value       | Select/setting range |                       |                |
| TOP screen   | —                                   | COMM                | —                    | MENU                  | -              |
| No.1 screen  | Serial protocol                     | ASC                 | ASC/RTU              | PROT                  | 3.5.2          |
| No.2 screen  | Communication specification         | 485                 | 485/232C             | TYPE                  |                |
| No.3 screen  | RS-485 terminal unit                | OFF                 | OFF/ON               | TERM                  |                |
| No.4 screen  | Slave address                       | 1                   | 1~32                 | SLV ⇒ ADDR            |                |
| No.5 screen  | Communication speed (bps)           | 19.2                | 9.6/19.2             | SPEED                 |                |
| No.6 screen  | Contact input signal 1 function     | OFF                 | OFF/RN.ST/RUN/SW     | D.IN1 ⇒ SEL           | 2.4.2          |
| No.7 screen  | Contact input signal 1 type         | ALT                 | ALT/MT               | D.IN1 ⇒ SW ⇒ TYPE     |                |
| No.8 screen  | Contact input signal 1 operation    | A                   | A/B                  | D.IN1 ⇒ CON ⇒ TYPE    |                |
| No.9 screen  | Contact input signal 2 function     | OFF                 | OFF/STOP/SW          | D.IN2 ⇒ SEL           |                |
| No.10 screen | Contact input signal 2 type         | ALT                 | ALT/MT               | D.IN2 ⇒ SW ⇒ TYPE     |                |
| No.11 screen | Contact input signal 2 operation    | A                   | A/B                  | D.IN2 ⇒ CON ⇒ TYPE    |                |
| No.12 screen | Contact output signal 1 function    | RUN                 | *1                   | D.OUT1 ⇒ SEL          |                |
| No.13 screen | Contact output signal 1 operation   | A                   | A/B                  | D.OUT1 ⇒ TYPE         |                |
| No.14 screen | Contact output signal 1 alarm       | AL.01               | AL.01~AL.32          | D.OUT1 ⇒ ALARM ⇒ CODE |                |
| No.15 screen | Contact output signal 1 maintenance | MT.01               | MT.01~MT.05          | D.OUT1 ⇒ MANT ⇒ CODE  |                |
| No.16 screen | Contact output signal 2 function    | RMT                 | *1                   | D.OUT2 ⇒ SEL          |                |
| No.17 screen | Contact output signal 2 operation   | A                   | A/B                  | D.OUT2 ⇒ TYPE         |                |
| No.18 screen | Contact output signal 2 alarm       | AL.01               | AL.01~AL.32          | D.OUT2 ⇒ ALARM ⇒ CODE |                |
| No.19 screen | Contact output signal 2 maintenance | MT.01               | MT.01~MT.05          | D.OUT2 ⇒ MANT ⇒ CODE  |                |
| No.20 screen | Contact output signal 3 function    | ALM                 | *1                   | D.OUT3 ⇒ SEL          |                |
| No.21 screen | Contact output signal 3 operation   | B                   | A/B                  | D.OUT3 ⇒ TYPE         |                |
| No.22 screen | Contact output signal 3 alarm       | AL.01               | AL.01~AL.32          | D.OUT3 ⇒ ALARM ⇒ CODE |                |
| No.23 screen | Contact output signal 3 maintenance | MT.01               | MT.01~MT.05          | D.OUT3 ⇒ MANT ⇒ CODE  |                |

\*1 Selectable from OFF/RUN/RMT/EXT.C/RDY/T.OUT/FLT/WRN/MENT/ALM/SW1/SW2/A.SEL/M.SEL

# Chapter 2 Contact input/output communication

The device is equipped with a terminal which runs/stops the product. It is also equipped with a terminal which picks up operation signals, alarm signals and setting condition.

The device starts contact input/output communication according to the setting of the operation display panel. Contact input/output communication can be customized by changing the settings. Table 2-1 "Customizable content" shows the contents which can be changed by the operation display panel.

Table 2-1 Customizable content

| Signal                        | Can be changed   |
|-------------------------------|--|
| Contact input signal (2pcs.)  | Signal configuration (Alternate/Momentary)             |
| Contact output signal (3pcs.) | Type of signal, signal operation (N.O type / N.C type) |

## 2.1 Precautions for communication

### 2.1.1 Precautions wiring communication

#### ○Communication wiring

A communication cable that connects the product and customer system is not included with the product. Please prepare a cable, referring to 2.3 "Connection explanation". In order to avoid malfunction, do not connect to any place other than those shown in 2.3 "Connection explanation".

#### ○Power supply

To use the power of the product, the total load current must be 500mA or less.

### 2.1.2 Precautions after wiring and before communication

○Check or set the communication mode by the operation display panel.

- Communication mode shall be DIO.

Other modes can perform reading, but only DIO mode can perform writing.

## 2.2 Communication specification

Table 2.2-1 DIO Communication specification

| Item                             |                      | Specification   |
|----------------------------------|----------------------|---|
| Connector type(for this product) |                      | Dsub 15P type female connector                                    |
| Contact input signal             | Insulation system    | Photo coupler   |
|                                  | Rated input voltage  | DC24V   |
|                                  | Used input voltage   | DC 21.6 to 26.4V  |
|                                  | Rated input current  | 5mA TYP   |
|                                  | Input signal         | 4.7kΩ   |
| Contact output signal            | Rated load voltage   | AC48V or less/DC30V or less                                       |
|                                  | Maximum load current | AC/DC 500mA (Resistance load)                                     |
|                                  | Minimum load current | DC5V 10mA   |
| DC24V output voltage             |                      | DC24V ± 10% 500mA MAX<br>(It can not be used for inductive load.) |

## 2.3 Connection explanation

This part explains the port of the contact input/output communication. A communication cable that connects the product and customer system is not included with the product.

Table 2.3-1 Contact input/output pin number

| PIN no | Application                       | Division | Default setting                  | Setting available |
|--------|-----------------------------------|----------|----------------------------------|-------------------|
| 1      | DC 24V output                     | Output   |                                  |                   |
| 2      | DC 24V output                     | Output   |                                  |                   |
| 3      | DC 24V output                     | Output   |                                  |                   |
| 4      | Contact input signal 1            | Input    | None                             | ○                 |
| 5      | Common of contact output signal 1 | Output   |                                  |                   |
| 6      | Common of contact output signal 2 | Output   |                                  |                   |
| 7      | Common of contact output signal 3 | Output   |                                  |                   |
| 8      | None                              | -        |                                  |                   |
| 9      | 24 COM output                     | Output   |                                  |                   |
| 10     | 24 COM output                     | Output   |                                  |                   |
| 11     | Common of contact input signal    | Output   |                                  |                   |
| 12     | Contact input signal 2            | Input    | None                             | ○                 |
| 13     | Contact output signal 1           | Output   | Run status signal<br>(N.O. type) | ○                 |
| 14     | Contact output signal 2           | Output   | Remote signal (N.O. type)        | ○                 |
| 15     | Contact output signal 3           | Output   | Alarm signal (N.C. type)         | ○                 |

## 2.4 Setting and checking

### 2.4.1 Setting and checking

The table below explains the setting items of the contact input/output signal and the initial values.

Table 2.4-1 List of set communication items

| Display No.  | Item                                | Display unit        |                      |                       | Contents   |
|--------------|-------------------------------------|---------------------|----------------------|-----------------------|--|
|              |                                     | Upper stage (White) |                      | Lower stage (Green)   |  |
|              |                                     | Initial value       | Select/setting range |                       |  |
| TOP screen   | —                                   | COMM                | —                    | MENU                  | Communication setting menu TOP screen                    |
| No.6 screen  | Contact input signal 1 function     | OFF                 | OFF/RN.ST/RUN/SW     | D.IN1 ⇒ SEL           | Setting function of contact input signal 1.              |
| No.7 screen  | Contact input signal 1 type         | ALT                 | ALT/MT               | D.IN1 ⇒ SW ⇒ TYPE     | Setting input type of contact input signal 1.            |
| No.8 screen  | Contact input signal 1 operation    | A                   | A/B                  | D.IN1 ⇒ CON ⇒ TYPE    | Setting input operation of contact input signal 1.       |
| No.9 screen  | Contact input signal 2 function     | OFF                 | OFF/STOP/SW          | D.IN2 ⇒ SEL           | Setting function of contact input signal 2.              |
| No.10 screen | Contact input signal 2 type         | ALT                 | ALT/MT               | D.IN2 ⇒ SW ⇒ TYPE     | Setting input type of contact input signal 2.            |
| No.11 screen | Contact input signal 2 operation    | A                   | A/B                  | D.IN2 ⇒ CON ⇒ TYPE    | Setting input operation of contact input signal 2.       |
| No.12 screen | Contact output signal 1 function    | RUN                 | ※1                   | D.OUT1 ⇒ SEL          | Setting function of contact input signal 1.              |
| No.13 screen | Contact output signal 1 operation   | A                   | A/B                  | D.OUT1 ⇒ TYPE         | Setting output operation of contact output signal 1.     |
| No.14 screen | Contact output signal 1 alarm       | AL.01               | AL.01 ~ AL.32        | D.OUT1 ⇒ ALARM ⇒ CODE | Setting selected alarm of contact output signal 1.       |
| No.15 screen | Contact output signal 1 maintenance | MT.01               | MT.01 ~ MT.05        | D.OUT1 ⇒ MANT ⇒ CODE  | Setting selected maintenance of contact output signal 1. |
| No.16 screen | Contact output signal 2 function    | RMT                 | ※1                   | D.OUT2 ⇒ SEL          | Setting function of contact output signal 2.             |
| No.17 screen | Contact output signal 2 operation   | A                   | A/B                  | D.OUT2 ⇒ TYPE         | Setting output operation of contact output signal 2.     |
| No.18 screen | Contact output signal 2 alarm       | AL.01               | AL.01 ~ AL.32        | D.OUT2 ⇒ ALARM ⇒ CODE | Setting selected alarm of contact output signal 2.       |
| No.19 screen | Contact output signal 2 maintenance | MT.01               | MT.01 ~ MT.05        | D.OUT2 ⇒ MANT ⇒ CODE  | Setting selected maintenance of contact output signal 2. |
| No.20 screen | Contact output signal 3 function    | ALM                 | ※1                   | D.OUT3 ⇒ SEL          | Setting function of contact output signal 3.             |
| No.21 screen | Contact output signal 3 operation   | B                   | A/B                  | D.OUT3 ⇒ TYPE         | Setting output operation of contact output signal 3.     |
| No.22 screen | Contact output signal 3 alarm       | AL.01               | AL.01 ~ AL.32        | D.OUT3 ⇒ ALARM ⇒ CODE | Setting selected alarm of contact output signal 3.       |
| No.23 screen | Contact output signal 3 maintenance | MT.01               | MT.01 ~ MT.05        | D.OUT3 ⇒ MANT ⇒ CODE  | Setting selected maintenance of contact output signal 3. |

\*1: Selectable from OFF/RUN/RMT/EXT.C/RDY/T.OUT/FLT/WRN/MENT/ALM/SW1/SW2/A.SEL/M.SEL

## 2.4.2 Setting and checking

Communication setting menu TOP screen

1. Displays communication setting menu.

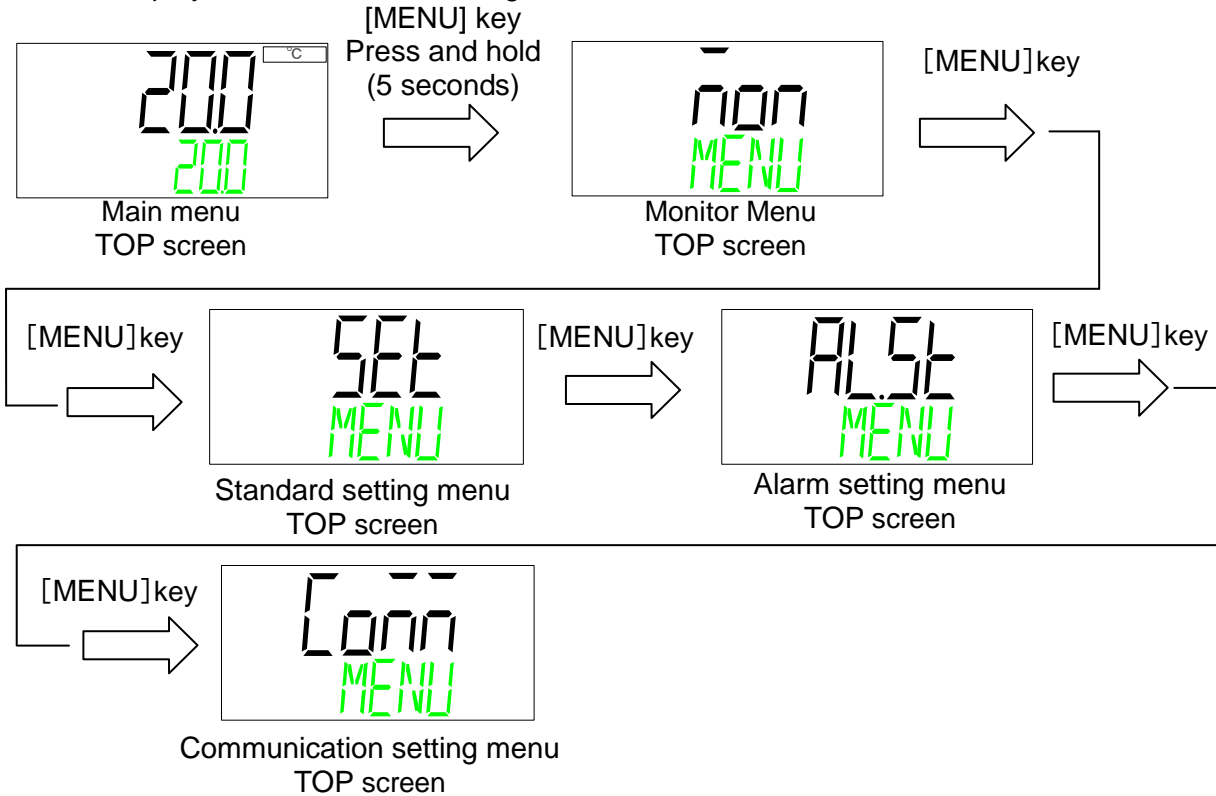

Contact input signal 1 function

2. Press the [▼] key. Displays screen for setting the function of the Contact input signal 1

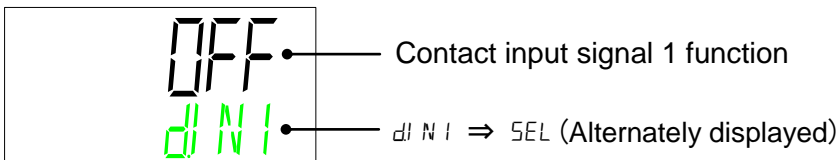

Displays the function for the Contact input signal 1.

| Set value | Contents                     | Initial value |
|-----------|------------------------------|---------------|
| OFF       | No input signal              | ○             |
| RNSL      | Run / stop signal is input   | —             |
| RUN       | Run signal is input          | —             |
| SB        | External switch signal input | —             |



Contact input signal 1 type

**3.** Press the [▼] key. Displays screen for setting the type of Contact input signal 1.

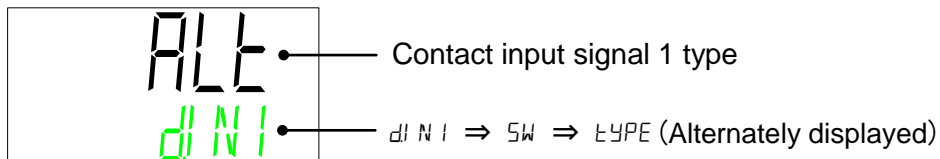

Displays the type of Contact input signal 1.

| Set value  | Contents         | Initial value |
|------------|------------------|---------------|
| ALt        | Alternate signal | ○             |
| $\bar{n}t$ | Momentary signal | —             |

Contact input signal 1 operation

**4.** Press the [▼] key. Displays screen for setting the operation of the Contact input signal 1.

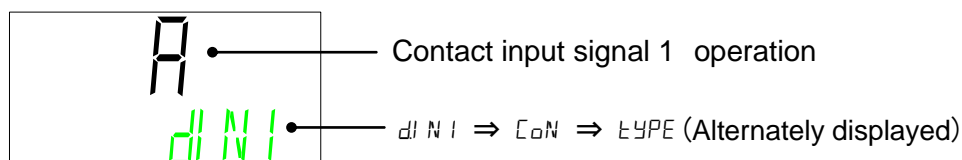

Select the Contact input signal 1 operation.

| Set value | Contents  | Initial value |
|-----------|-----------|---------------|
| A         | N.O. type | ○             |
| B         | N.C. type | —             |

Contact input signal 2 Select function

**5.** Press the [▼] key. Displays screen for setting the function of the Contact input signal 2.

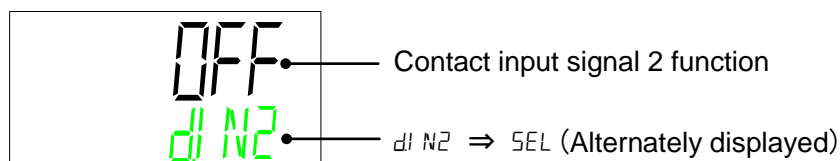

Displays the function of the Contact input signal 2.

| Set value | Contents                     | Initial value |
|-----------|------------------------------|---------------|
| oFF       | No input signal              | ○             |
| StoP      | Stop signal input            | —             |
| Sw        | External switch signal input | —             |

Contact input signal 2 type

6. Press the [▼] key. Displays screen for setting the type of Contact input signal 2.

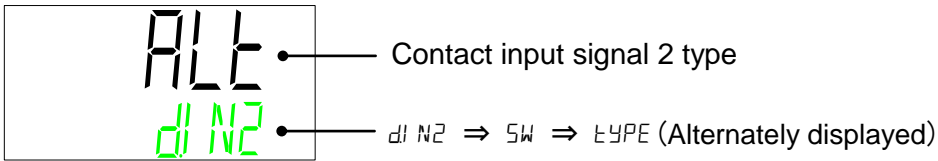

Displays the type of Contact input signal 2.

| Set value  | Contents         | Initial value |
|------------|------------------|---------------|
| ALt        | Alternate signal | ○             |
| $\bar{n}t$ | Momentary signal | —             |

Contact input signal 2 operation

7. Press the [▼] key. Displays screen for setting the operation of the Contact input signal 2.

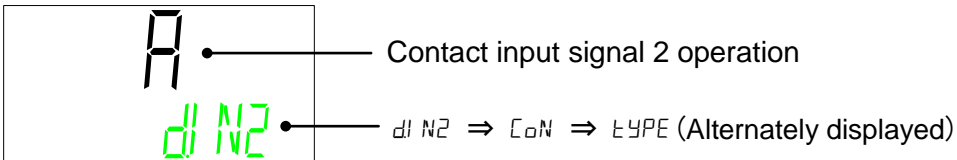

Select the Contact input signal 2 operation.

| Set value | Contents  | Initial value |
|-----------|-----------|---------------|
| A         | N.O. type | ○             |
| B         | N.C. type | —             |

Contact output signal 1 function

8. Press the [▼] key. Displays setting screen for function of contact output signal 1 .

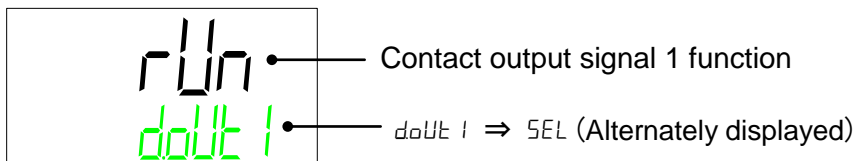

Displays the function of the Contact output signal 1.

| Set value  | Explanation  | Initial value (Default setting) |
|------------|--|---------------------------------|
| OFF        | No output signal   | —                               |
| run        | Operation status signal output                           | ○                               |
| remote     | Remote status signal output                              | —                               |
| —          | Unused   | —                               |
| rdy        | Ready completion (TEMP READY) signal output              | —                               |
| temp out   | TEMP OUT (temperature is out of the range) signal output | —                               |
| FLT        | FLT (operation stop) alarm signal output                 | —                               |
| WRN        | WRN (operation continue alarm) signal output             | —                               |
| notice     | Notice for maintenance signal output                     | —                               |
| ALM        | Alarm status signal output                               | —                               |
| S1         | Pass through signal of the contact input signal 1        | —                               |
| S2         | Pass through signal of the contact input signal 2        | —                               |
| ALSEL      | Selected alarm status signal output                      | —                               |
| notice SEL | Selected notice for maintenance signal output            | —                               |

Contact output signal 1 operation

9. Press the [▼] key. Displays screen for setting the operation for the Contact output signal 1.

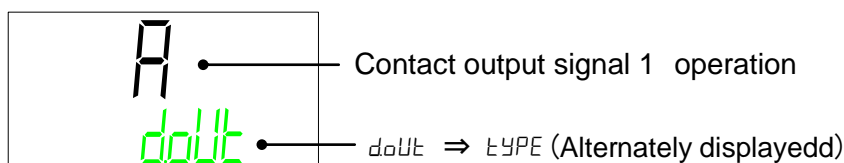

Select the Contact output signal 1 operation.

| Set value | Contents  | Initial value |
|-----------|-----------|---------------|
| A         | N.O. type | ○             |
| B         | N.C. type | —             |

Contact output signal 1 selected alarm

10. Press the [▼] key. Displays screen for setting the selected alarm for the Contact output signal 1. The alarm is valid when the “selected alarm status signal output” is active.

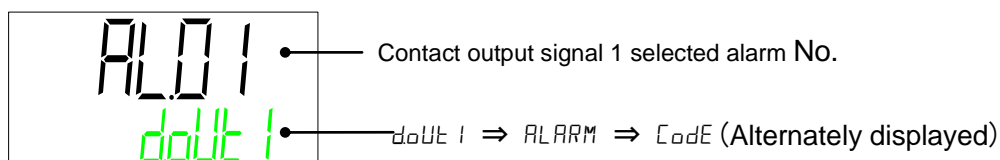

Select the alarm No. to be allocated to Contact output signal 1

- Setting range : AL.01~AL.32(Initial value : AL.01)

Contact output signal 1 Select maintenance

**11.** Press the [▼] key. Displays screen for setting the selected maintenance for the Contact output signal 1. The alarm is valid when the “selected maintenance status signal output” is active.

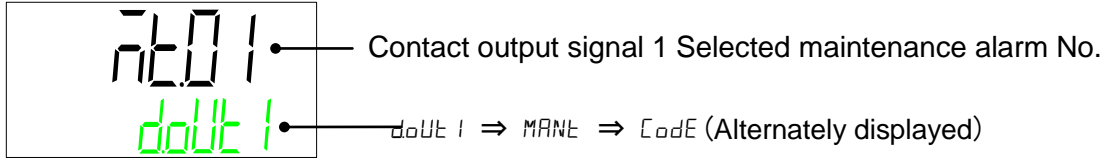

Select the maintenance alarm No. to be allocated to Contact output signal 1.

- Setting range: MT.01 to MT.05 (Initial value: MT.01)

Contact output signal 2 Select function

**12.** Press the [▼] key. Displays screen for setting the function for the Contact output signal 2.

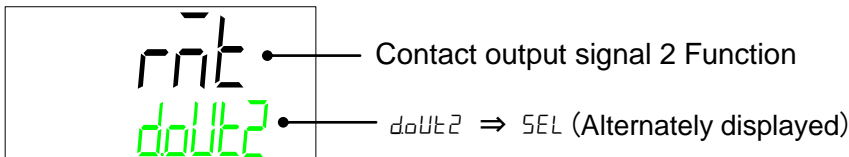

Displays the function for the Contact output signal 2.

| Set value | Explanation  | Initial value (Default setting) |
|-----------|--|---------------------------------|
| oFF       | No output signal   | —                               |
| rUn       | Operation status signal output                           | —                               |
| rnt       | Remote status signal output                              | ○                               |
| ELtC      | Unused   | —                               |
| rdy       | Ready completion (TEMP READY) signal output              | —                               |
| tOUT      | TEMP OUT (temperature is out of the range) signal output | —                               |
| FLt       | FLT (operation stop) alarm signal output                 | —                               |
| WRt       | WRN (operation continue alarm) signal output             | —                               |
| nRnt      | Notice for maintenance signal output                     | —                               |
| ALn       | Alarm status signal output                               | —                               |
| Sb1       | Pass through signal of the contact input signal 1        | —                               |
| Sb2       | Pass through signal of the contact input signal 2        | —                               |
| A.SEL     | Selected alarm status signal output                      | —                               |
| n.SEL     | Selected notice for maintenance signal output            | —                               |

Contact output signal 2 operation

**13.** Press the [▼] key. Displays screen for setting the operation for the Contact output signal 2

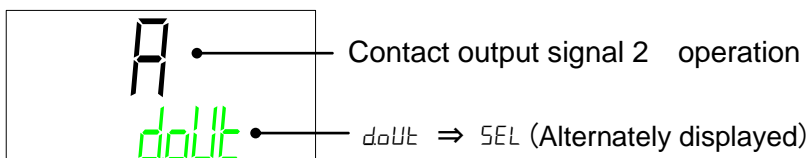

Select the contact output signal 2 operation.

| Set value | Contents  | Initial value |
|-----------|-----------|---------------|
| A         | N.O. type | ○             |
| B         | N.C. type | —             |

Contact output signal 2 selected alarm

- 14.** Press the [▼] key. Displays screen for setting the selected alarm for the Contact output signal 2. The alarm is valid when the “selected alarm status signal output” is active.

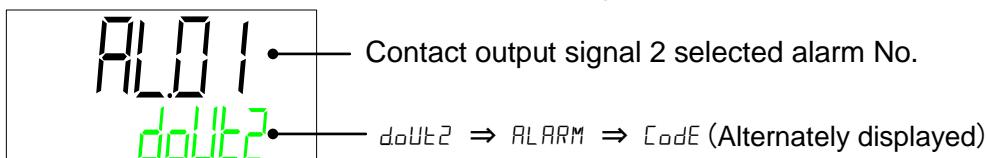

Select the alarm No. to be assigned to contact output signal 2.

- Setting range: AL.01 ~ AL.32 (Initial value: AL.01)

Contact output signal 2 Select maintenance

- 15.** Press the [▼] key. Displays screen for setting the selected maintenance of the Contact output signal 2. The alarm is valid when the “selected maintenance status signal output” is selected.

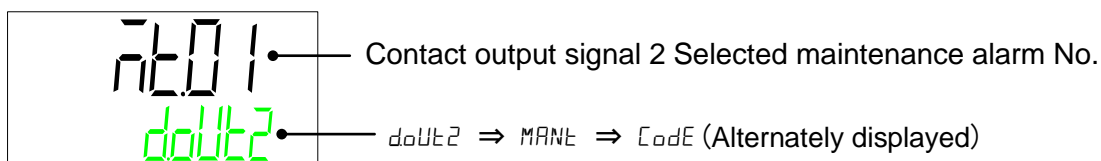

Select the maintenance alarm No. to be allocated to Contact output signal 2.

- Setting range: MT.01 to MT.05 (Initial value: MT.01)

Contact output signal 3 Select function

- 16.** Press the [▼] key. Displays screen for setting the function of the Contact output signal 3

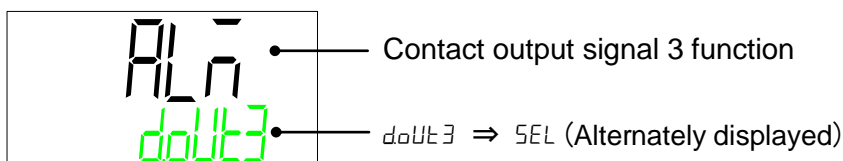

Select contact output signal 3 function

| Set value | Explanation  | Initial value<br>(Default setting) |
|-----------|--|------------------------------------|
| oFF       | No output signal   | —                                  |
| rUn       | Operation status signal output                           | —                                  |
| rnE       | Remote status signal output                              | —                                  |
| ELtE      | Unused   | —                                  |
| rDY       | Ready completion (TEMP READY) signal output              | —                                  |
| tOUT      | TEMP OUT (temperature is out of the range) signal output | —                                  |
| FLt       | FLT (operation stop) alarm signal output                 | —                                  |
| WRt       | WRN (operation continue alarm) signal output             | —                                  |
| nAnt      | Notice for maintenance signal output                     | —                                  |
| ALn       | Alarm status signal output                               | ○                                  |
| SH1       | Pass through signal of the contact input signal 1        | —                                  |
| SH2       | Pass through signal of the contact input signal 2        | —                                  |
| ASEL      | Selected alarm status signal output                      | —                                  |
| aSEL      | Selected notice for maintenance signal output            | —                                  |

Contact output signal 3 operation

**17.** Press the [▼] key. Displays screen for setting the operation of the Contact output signal 3.

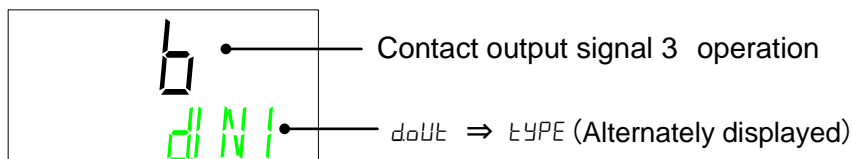

Contact output signal 3 operation

| Set value | Contents  | Initial value |
|-----------|-----------|---------------|
| A         | N.O. type | —             |
| B         | N.C. type | ○             |

Contact output signal 3 select alarm

**18.** Press the [▼] key. Displays screen for setting the selected alarm of Contact output signal 3. The alarm is valid when the “selected alarm status signal output” is active.

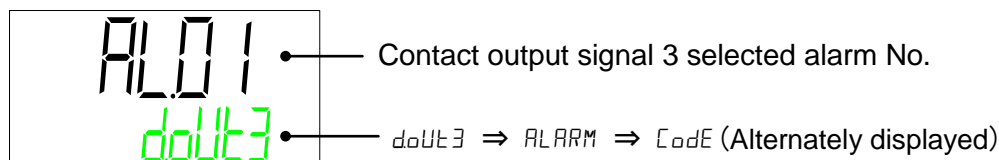

Select the alarm No. to be allocated to Contact output signal 3

- Setting range: AL.01 to AL32 (Initial value: AL01)

## Contact output signal 3 Select maintenance

- 19.** Press the [▼] key. Displays screen for setting the selected maintenance of Contact output signal 3. The alarm is valid when the “selected maintenance status signal output” is active.

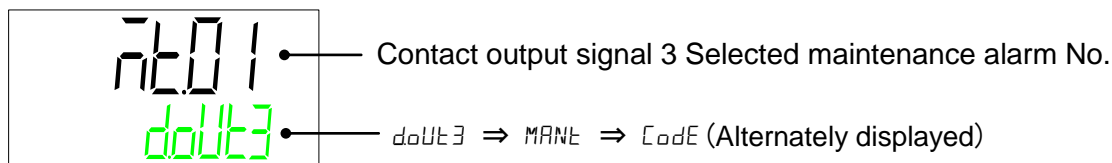

Select the maintenance alarm No. to be allocated to Contact output signal 3.

- Setting range: MT.01 to MT.05 (Initial value: MT.01)

## 2.5 Contact input signal

There are two contact input signals. As the default condition, contact input signal 1, and contact input signal 2 are not used. The input signals can be customized depending on the customer's application.

The combination of possible settings of contact input signals is limited. Refer to Table 2.5-2 for possible combinations.

Table 2.5-1 Contact input signal type

|                        | Class of signal              |           | Signal configuration |          | Signal operation |         | Timer                  |               | Default setting |
|------------------------|------------------------------|-----------|----------------------|----------|------------------|---------|------------------------|---------------|-----------------|
|                        | Description                  | Display   | Description          | Display  | Description *1   | Display | Delay timer of reading | OFF detection |                 |
| Contact input signal 1 | Run/stop signal              | RN.ST     | Alternate            | ALT      | N.O.type         | A       | -                      | -             | -               |
|                        |                              |           |                      |          | N.C.type         | B       | -                      | -             | -               |
|                        |                              |           | Momentary            | MT       | N.O.type         | A       | -                      | -             | -               |
|                        |                              |           |                      |          | N.C.type         | B       | -                      | -             | -               |
|                        | Run signal                   | RUN       | Alternate            | ALT      | N.O.type         | A       | -                      | -             | -               |
|                        |                              |           |                      |          | N.C.type         | B       | -                      | -             | -               |
|                        |                              |           | Momentary            | MT       | N.O.type         | A       | -                      | -             | -               |
|                        |                              |           |                      |          | N.C.type         | B       | -                      | -             | -               |
|                        | External switch signal input | SW        | Alternate            | ALT      | N.O.type         | A       | Used                   | Used          | -               |
|                        |                              |           |                      |          | N.C.type         | B       | Used                   | Used          | -               |
|                        |                              |           | Momentary            | MT       | N.O.type         | A       | Used                   | Used          | -               |
|                        |                              |           |                      |          | N.C.type         | B       | Used                   | Used          | -               |
| Without input signal   | OFF                          | Alternate | ALT                  | N.O.type | A                | -       | -                      | ○             |                 |
|                        |                              |           |                      | N.C.type | B                | -       | -                      | -             |                 |
|                        |                              | Momentary | MT                   | N.O.type | A                | -       | -                      | -             |                 |
|                        |                              |           |                      | N.C.type | B                | -       | -                      | -             |                 |
| Contact input signal 2 | Stop signal                  | STOP      | Alternate            | ALT      | N.O.type         | A       | -                      | -             | -               |
|                        |                              |           |                      |          | N.C.type         | B       | -                      | -             | -               |
|                        |                              |           | Momentary            | MT       | N.O.type         | A       | -                      | -             | -               |
|                        |                              |           |                      |          | N.C.type         | B       | -                      | -             | -               |
|                        | External switch signal input | SW        | Alternate            | ALT      | N.O.type         | A       | Used                   | Used          | -               |
|                        |                              |           |                      |          | N.C.type         | B       | Used                   | Used          | -               |
|                        |                              |           | Momentary            | MT       | N.O.type         | A       | Used                   | Used          | -               |
|                        |                              |           |                      |          | N.C.type         | B       | Used                   | Used          | -               |
|                        | Without input signal         | OFF       | Alternate            | ALT      | N.O.type         | A       | -                      | -             | ○               |
|                        |                              |           |                      |          | N.C.type         | B       | -                      | -             | -               |
|                        |                              |           | Momentary            | MT       | N.O.type         | A       | -                      | -             | -               |
|                        |                              |           |                      |          | N.C.type         | B       | -                      | -             | -               |

\*1 N.O.type: normally open (N.O.), N.C.type: normally closed (N.C.).

Table 2.5-2 Combinations of contact input signals

| Contact input 1 function selection | Contact input 2 function selection |      |    |
|------------------------------------|------------------------------------|------|----|
|                                    | OFF                                | STOP | SW |
| OFF                                | ○                                  | ×    | ○  |
| RN.ST                              | ○                                  | ×    | ○  |
| RUN                                | ×                                  | ○    | ×  |
| SW                                 | ○                                  | ×    | ○  |

○: Settable ×: Not settable



### 2.5.1 Run/stop·Run·Stop·External switch signal

- 1) Run/stop signal (Signal type: Alternate)  
 The product keeps operating while the input signal from the customer is ON.

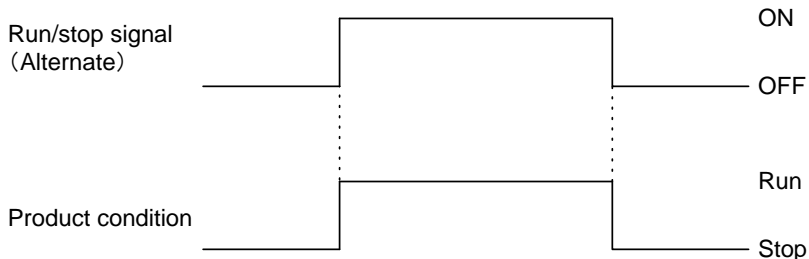

- 2) Run/stop signal (Signal type: Momentary)  
 The state changes when the input signal from the customer goes ON. This signal operates while the product is stopped, and stops while the product is being operated.

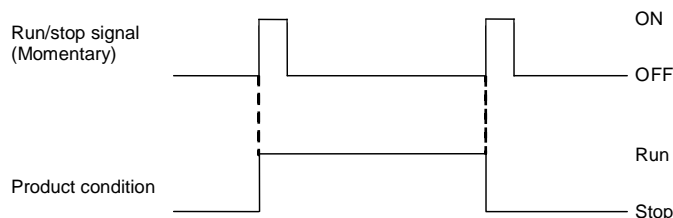

- 3) Run signal (Signal type: Alternate) /Stop signal (Signal type: Alternate)  
 Digital input signal 1 is for Run signal (Signal type : Alternate) , digital input signal 2 is for stop signal(Signal type: Alternate). Stop signal becomes valid when both signals are turned ON.

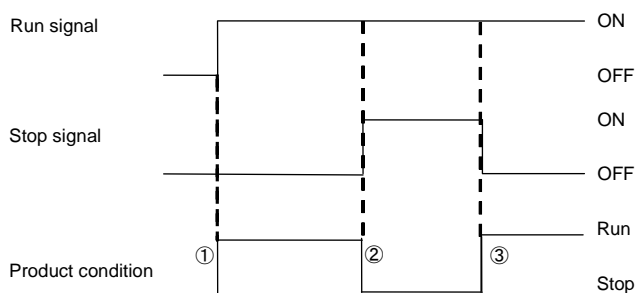

- ① The product starts operation when the contact input signal 1 is turned ON.
- ② The product stops operation when the contact input signal 2 is turned ON.
- ③ The product starts operation because the contact input signal 1 is turned ON although the contact input signal 2 is OFF.

4) Digital input signal 1 is for Run/Stop signal (Signal type: Alternate), digital input signal 2 is for external switch signal (Signal type: Alternate). Refer to Chapter 2.5.2 for details of the external switch.

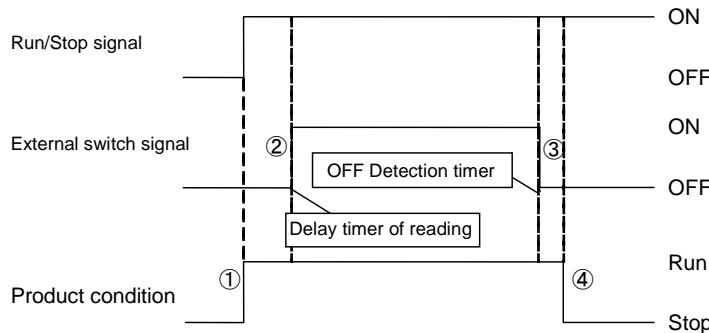

- ① The product starts operation when the Run/Stop signal from the user is turned on.
  - ② It reads the signal of the external switch signal (N.O type) after the time which has been set for the delay timer of reading. The factory default setting of the delay timer of reading is 0sec. Refer to 2.4.2 for setting.
  - ③ When the external switch signal (N.O. type) has been turned off for the time set for OFF detection timer, it is recognized as OFF. The factory default setting of the OFF detection timer is 0sec. Refer to 2.4.2 for setting.
  - ④ AL26 contact input 2 signal detection alarm is generated. The operation of the product stops. "Operation stop" is the default setting for AL26. The product can be set to continue operation or not to detect the alarm. Refer to the "Installation / Operation" manual for details.
- \*The product stops operation when the Run/Stop signal is turned off during operation. Afterwards, the alarm is not generated even if the external switch signal is turned off.

### 2.5.2 Signal of the external switch

This product can be monitored by reading the signal of the external switch prepared by the customer.

This product generates an alarm and stops operating when a problem is detected from the external switch.

Monitoring mode can be selected from "continuous monitoring" or "monitoring only during operation". Refer to Table 2.5-3.

Select the external switch 1 or 2 or both depending on the customer's system. Refer to 2.4.2 for setting method.

The number of monitored external switches depends on the contact input signal function. Refer to Table 2.5-3

You can set the product to continue operation or not to detect the alarm. Refer to the "Installation / Operation" manual for details

Table 2.5-3 Monitoring method for contact input

| Contact input delay timer for reading | Monitoring method             |
|---------------------------------------|-------------------------------|
| 0 sec                                 | Continuous monitoring         |
| 1 to 300 sec                          | Monitor only during operation |

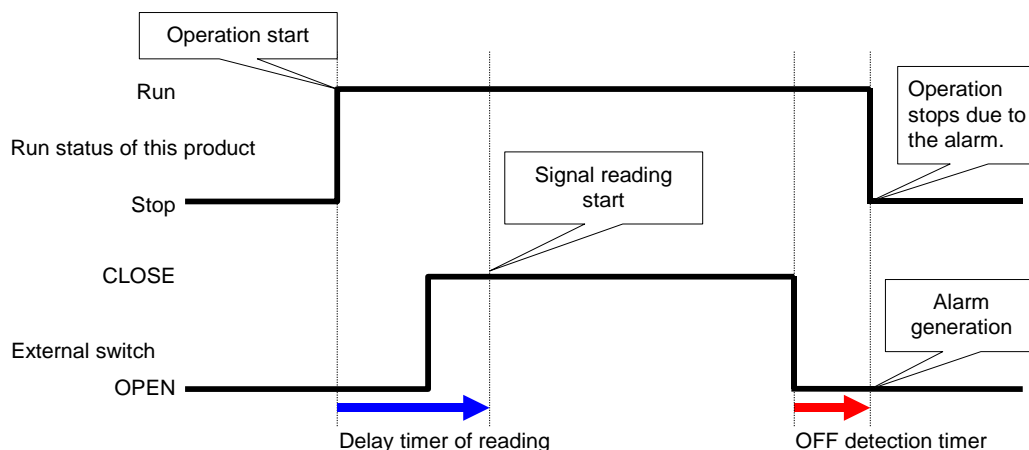

#### ■ Delay timer of reading

If the signal of the external switch prepared by the customer is not closed instantly when the product is operated, set the delay timer for reading. By setting this timer, the external switch monitoring starts after the time set by the delay time of reading since the operation start. "0" is the default setting. Set a time which is suitable for your environment.

Example} When using a flow switch

When operation is started, it takes time for the fluid to reach the piping and the flow switch to detect the flow. Set the time for the flow switch to start.

#### ■ OFF detection timer

If you do not want the alarm to be generated instantly when the external switch prepared by the customer is in open status, but instead want the alarm to be generated after the switch has been open for a specific time (continuous open status), set the OFF detection timer.

This timer enables the alarm to be generated when the time set for OFF detection time passes after the switch is in OPEN status. The default setting is 0 sec. Set a time which is suitable for your application.

#### ■ Contact input

N.O type normally open (N.O.) or N.C. type normally closed (N.C.) can be selected for the external switch. Set the signal which is suitable for the external switch prepared by the customer.

## 2.6 Contact output signal

There are three contact output signals. As the default setting, contact output signal 1 is for operating condition (N.O type), contact output signal 2 is for remote signal (N.O type), and contact output signal 3 is for alarm signal (N.C type). Refer to Table 2-6-1. Depending on the product condition, contact output signal is turned on (closed) or turned off (open).

The signals can be customized depending on the customer’s application. The Table 2.6-2 shows operation of contact output signal.

**[Tips]**

All contact output signals are turned off (open) when the power is not supplied.

Table 2.6-1 Contact output signal (Default setting)

|                         | Class of signal   |         | Signal configuration |         |
|-------------------------|-------------------|---------|----------------------|---------|
|                         | Description       | Display | Description #1       | Display |
| Contact output signal 1 | Run status signal | RUN     | N.O type             | A       |
| Contact output signal 2 | Remote signal     | RMT     | N.O type             | A       |
| Contact output signal 3 | Alarm signal      | ALM     | N.C type             | B       |

\*1 N.O.type : normally open (N.O.), N.C.type : normally open (N.O.)

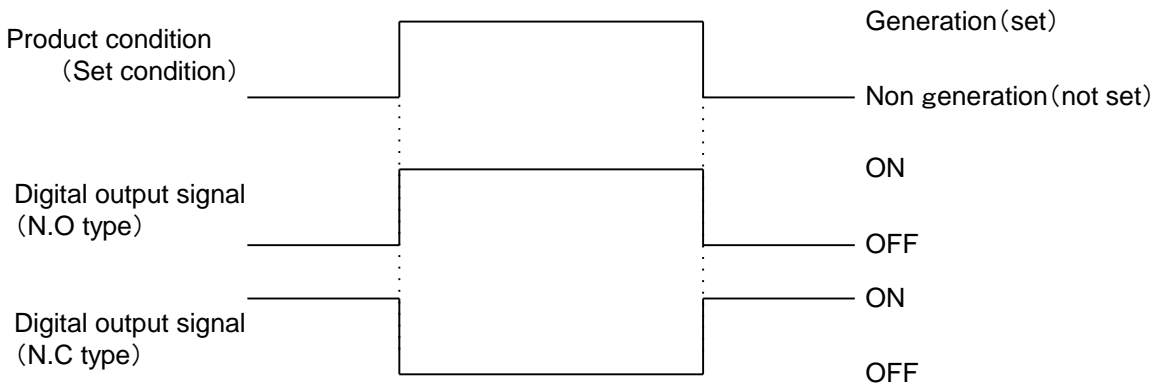

Table 2.6-2 Operation of contact output signal

| Class of signal |   | Operation of contact output signal |  |
|-----------------|---|------------------------------------|--|
| Display         | Function  | Operation                          |  |
| OFF             | Without output                                    | N.O type                           | Normally, output signal is OFF (open)  |
|                 |   | N.C type                           | Normally, output signal is ON (close)  |
| RUN             | Run status signal                                 | N.O type                           | When the product operates, signal turns on.  |
|                 |   | N.C type                           | When the product operates, signal turns off.   |
| RMT             | Remote status signal                              | N.O type                           | When the product becomes SERIAL REMOTE, signal turns on.   |
|                 |   | N.C type                           | When the product becomes LOCAL, signal turns off.  |
| EXT.C           | External temperature control signal               | N.O type                           | Signal is turned on by activating the external temperature control function.   |
|                 |   | N.C type                           | Signal is turned off by activating the external temperature control function.  |
| RDY             | Signal for completion of preparation (TEMP READY) | N.O type                           | When the product becomes completion of preparation (TEMP READY), signal turns on.  |
|                 |   | N.C type                           | When the product becomes completion of preparation (TEMP READY), signal turns off.   |
| T.OUT           | TEMP OUT (temperature is out of the range) signal | N.O type                           | Signal is turned on when the temperature is out of the range (TEMP OUT).   |
|                 |   | N.C type                           | Signal is turned off when the temperature is out of the range (TEMP OUT).  |
| FLT             | Signal for operation stop alarm                   | N.O type                           | When operation stop alarm occurs, signal turns on.   |
|                 |   | N.C type                           | When operation stop alarm occurs, signal turns off.  |
| WRN             | Signal for continuing operation alarm             | N.O type                           | When continuing operation alarm occurs, signal turns on.   |
|                 |   | N.C type                           | When continuing operation alarm occurs, signal turns off.  |
| MENT            | Maintenance status signal                         | N.O type                           | The signal is turned on when the maintenance status signal is generated.   |
|                 |   | N.C type                           | The signal is turned off when the maintenance status signal is generated.  |
| ALM             | Alarm status signal                               | N.O type                           | When alarm occurs, signal turns on.  |
|                 |   | N.C type                           | When alarm occurs, signal turns off.   |
| SW              | Pass through signal of contact input signal       | N.O type                           | Outputs the signal which is input to the contact input signal.<br>Input signal is ON → Output signal is ON                 |
|                 |   | N.C type                           | Outputs the reverse of the signal which is input to the contact input signal.<br>Input signal is OFF → Output signal is ON |
| ASEL            | Alarm status signal                               | N.O type                           | The signal is turned ON when the selected alarm goes off.  |
|                 |   | N.C type                           | The signal is turned OFF when the selected alarm goes off.   |
| M.SEL           | Maintenance status signal                         | N.O type                           | The signal is turned on when the selected maintenance status signal is generated.  |
|                 |   | N.C type                           | The signal is turned off when the selected maintenance status signal is generated.   |



# Chapter 3 Serial communication

Serial communication (RS-485/RS232C) enables the remote control of run/start of the product, temperature setting and details of product condition, and alarm condition can be obtained.

The operating state of the product (run/stop) and the temperature setting can be monitored by sending a request message made by the program of the host computer (e.g. PC).

The communication protocol is MODBUS protocol.

## 3.1 Precautions wiring communication

### ○Communication wiring

A communication cable that connects the product and customer system is not included with the product. Please prepare a cable, referring to 3.2 "Connected explanation" In order to avoid malfunction, do not connect to any place other than those shown in 3.2 "Connected explanation".

## 3.2 Connected explanation

Fig 3.2-1 shows the wiring when RS-485 is selected as the communication standard. Fig 3.2-2 shows the wiring when RS-232C is selected. A communication cable that connects the product and customer system is not included with the product. Prepare a cable, referring to Fig 3.2-1 or Fig 3.2-2.

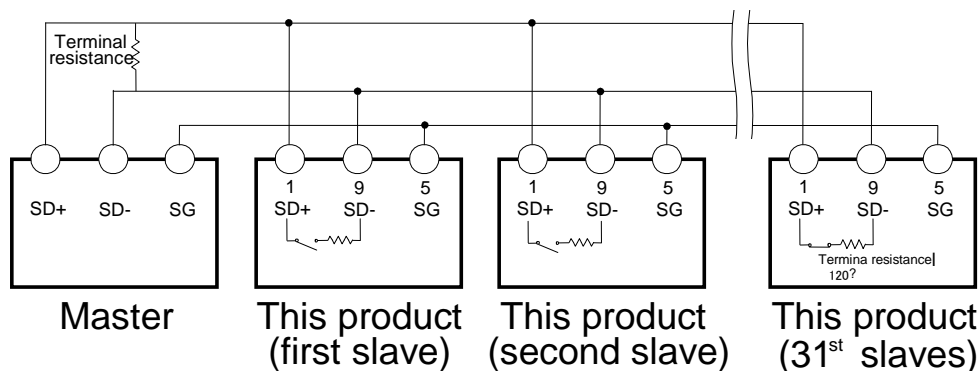

**Do not connect any wire to other PIN numbers.**

Fig 3.2-1 RS-485 connector connection

### **[Tips]**

- 1 master : 1 product, or 1 master: N products.  
In the latter case, up to 31 products can be connected.
- Both ends of the communication connection (the end nodes) need to be connected to the higher level computer.
- The terminal resistance of this product can be set by the operation display panel. Refer to "3.6.2 Setting and checking".

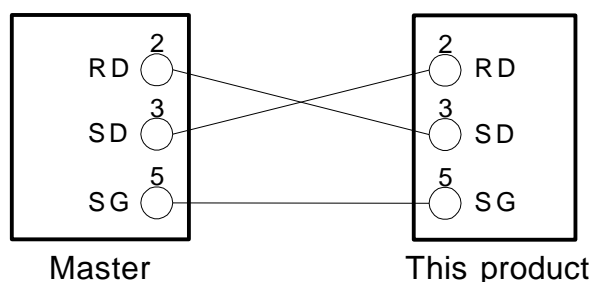

**Do not connect any wire to other PIN numbers.**

Fig 3.2-2 RS-232C connector connection

### 3.3 Communication specification

Table 3.3-1 Serial communication specification

| Item                             | Specification   |
|----------------------------------|---|
| Connector type (for the product) | D-sub9P type Female connector   |
| Standard                         | Select from EIA RS-485 / RS-232C  |
| Circuit type Half duplex         | Half duplex   |
| Transmission type                | Start-stop  |
| Protocol                         | MODBUS terminal*1   |
| Terminal resistance              | Select from with terminal resistance (120Ω) / Without terminal resistance |

■ : Default setting

\*1: Refer to Modicon Co. protocol specifications "PI-MBUS-300 Rev.J".

Table 3.2-2 Communication specification of MODBUS communication function

| Item                    | Specification                                     |
|-------------------------|---|
| Standard                | Select from EIA RS-485 / RS-232C                  |
| Communication speed     | Select from 9600bps / 19200bps                    |
| Data·bit length         | 7bit(ASCII) / 8bit(RTU)                           |
| Stop·bit length         | 1bit  |
| Data transfer direction | LSB   |
| Parity                  | Even parity                                       |
| Letter code             | ASCII character string (ASCII) / Binary data(RTU) |
| Node type               | Slave (Controller)                                |
| Slave address set range | Select from 1 to 32 address                       |
| Error check             | LRC method (ASCII) / CRC method (RTU)             |

■ : Default setting



## 3.4 MODBUS communication function

MODBUS protocol is a communication protocol developed by Modicon. It is used to communicate with a PC or PLC.

Register content is read and written by this communication protocol.

This communication has the following features.

- Controls run/stop.
- Sets and reads the circulating fluid set temperature.
- Reads the circulating fluid discharge temperature.
- Reads the condition of the product.
- Reads the alarm generating condition of the product.

Refer to “3.13 Register Map” for the register of the product.

## 3.5 Precautions for communication

### 3.5.1 Precautions after wiring and before communication

○ Check or set the each communication setting by the operation display panel.

- The communication specification shall be the customer’s communication standard.
- The communication mode shall be the SERIAL mode. (When serial mode is activated, this mode is selected. Refer to Chapter 3.13.11)

Other modes can perform reading, but only SERIAL mode can perform writing.

○ Check or set the communication parameters using the operation display panel.

Check or set the communication speed so that the product synchronizes with the host computer (master) prepared by the customer.

○ Check the slave address by the operation display panel.

No response is returned when a request message is sent from a slave address other than those set in the product.

### 3.5.2 Precautions for communicating

○ Allow a suitable interval between requests.

To send request messages in series, wait for 100 msec. or longer after receiving a response message from the product before sending the next message.

○ Retry (resend request message).

The response may not be returned due to noise. If no message is returned 1sec. after sending a request message, resend the request message.

○ If necessary send a read request message to check if it was written correctly.

Message to notify the completion of the process is returned when the action for the written request message is completed.

Send a read request message to confirm if the setting was written as requested.

○Setting limit of circulating fluid temperature

When the circulating fluid set temperature is written by communication, the data is stored in FRAM. When the product restarts, it restarts with the value which was set before the restart. The number of times it is possible to overwrite FRAM is limited. Data is only stored in FRAM when it receives a circulating fluid set temperature which is different from the previous temperatures. Please check how many times it is possible to overwrite FRAM, and avoid unnecessary changes of the circulating fluid set temperature during communication

## 3.6 Setting and checking

### 3.6.1 Setting and checking items

The table below explains the setting items of the MODBUS communication function and the initial values.

Table 3.6-1 Communication setting items

| Display No. | Item                        | Display unit        |                      |                     | Contents  |
|-------------|-----------------------------|---------------------|----------------------|---------------------|---|
|             |                             | Upper stage (White) |                      | Lower stage (Green) |   |
|             |                             | Initial value       | Select/setting range |                     |   |
| TOP screen  | —                           | COMM                | —                    | MENU                | Communication setting menu TOP screen                             |
| No.1 screen | Serial protocol             | ASC                 | ASC/RTU              | PROT                | Select serial protocol.   |
| No.2 screen | Communication specification | 485                 | 485/232C             | TYPE                | Select RS - 485 / RS - 232C.                                      |
| No.3 screen | RS-485 terminal unit        | OFF                 | OFF/ON               | TERM                | Select whether RS - 485 terminating resistance is present or not. |
| No.4 screen | Slave address               | 1                   | 1~32                 | SLV ⇒ ADDR          | Set the slave address.  |
| No.5 screen | Communication speed (bps)   | 19.2                | 9.6/19.2             | SPEED               | Set the communication speed.                                      |

### 3.6.2 Setting and checking

Communication setting menu TOP screen

1. Displays communication setting menu.

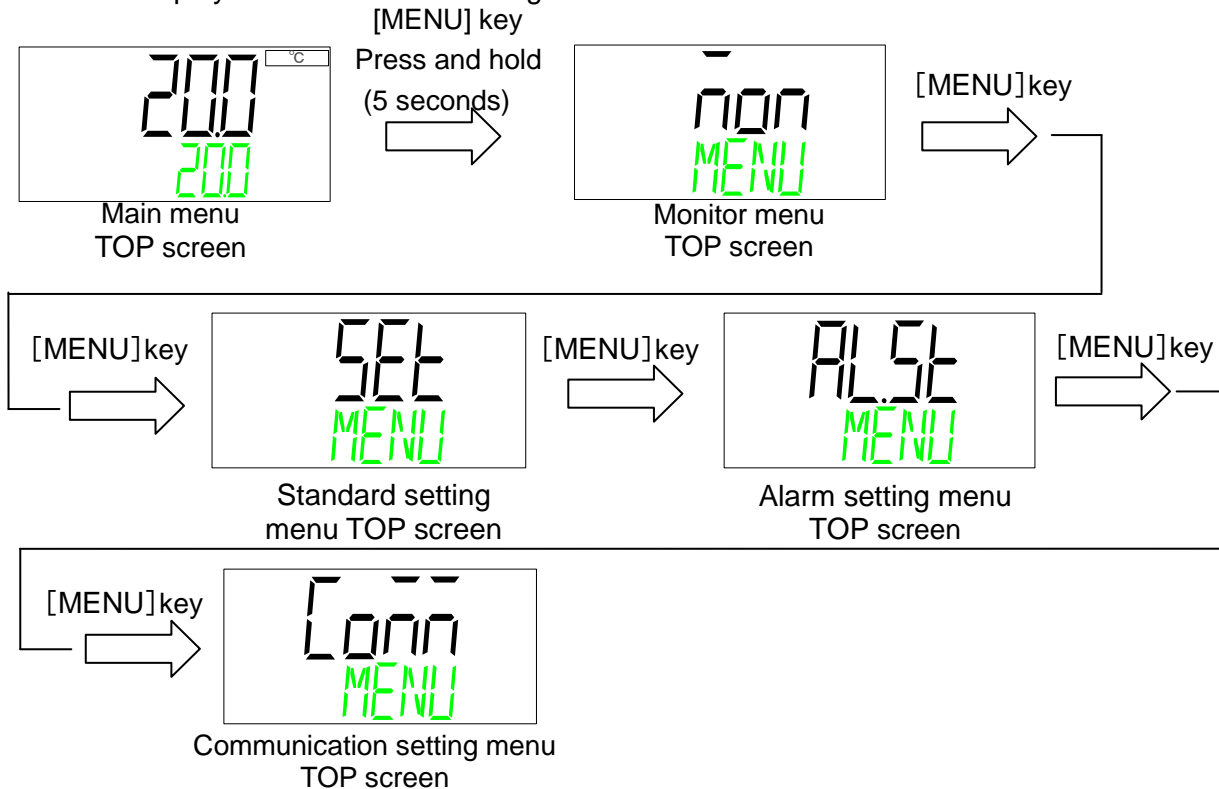

serial protocol

2. Press the [▼] key. Displays screen for setting the serial protocol.

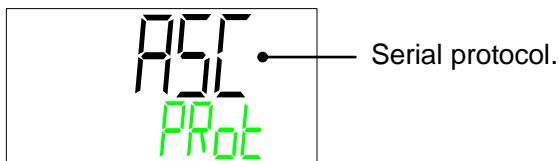

Select communication protocol.

| Set value | Contents   | Initial value |
|-----------|------------|---------------|
| ASC       | ASCII mode | ○             |
| RTU       | RTU mode   | —             |

Communication specification

- 3.** Press the [▼] key. Displays screen for setting the communication specifications.

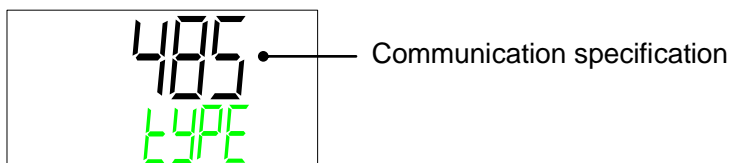

Select the communication specification.

| Set value | Contents | Initial value |
|-----------|----------|---------------|
| 485       | RS-485   | ○             |
| 232C      | RS-232C  | —             |

RS-485 terminal unit

- 4.** Press the [▼] key. Displays screen for setting RS-485 terminal unit.

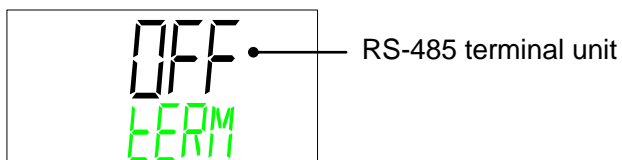

Select RS-485 terminal unit.

| Set value | Contents      | Initial value |
|-----------|---------------|---------------|
| oFF       | No terminal   | ○             |
| oN        | With terminal | —             |

Slave addresses

- 5.** Press the [▼] key. Displays screen for setting the slave address.

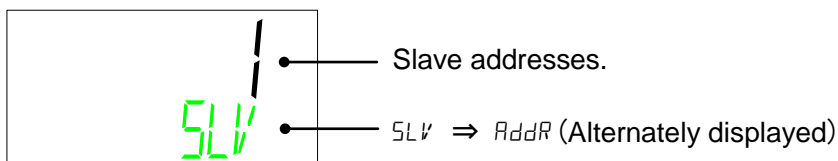

Sets slave address.

- Setting range: 1 to 32 (Initial value: 1)

Communication speed

6. Press the [▼] key. Displays screen for setting the communication speed.

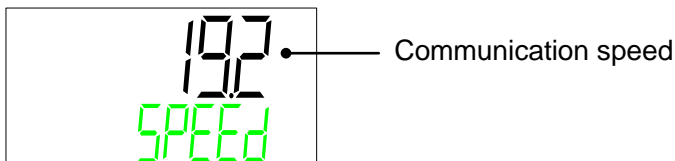

Selects the communication speed.

| Set value | Contents  | Initial value |
|-----------|-----------|---------------|
| 9.6       | 9600 bps  | —             |
| 19.2      | 19200 bps | ○             |

### 3.7 Communication sequence

Starts with a request message from the customer's system (host), and finishes with a response message from the product (slave). This product operates as a slave. It does not send any requests.

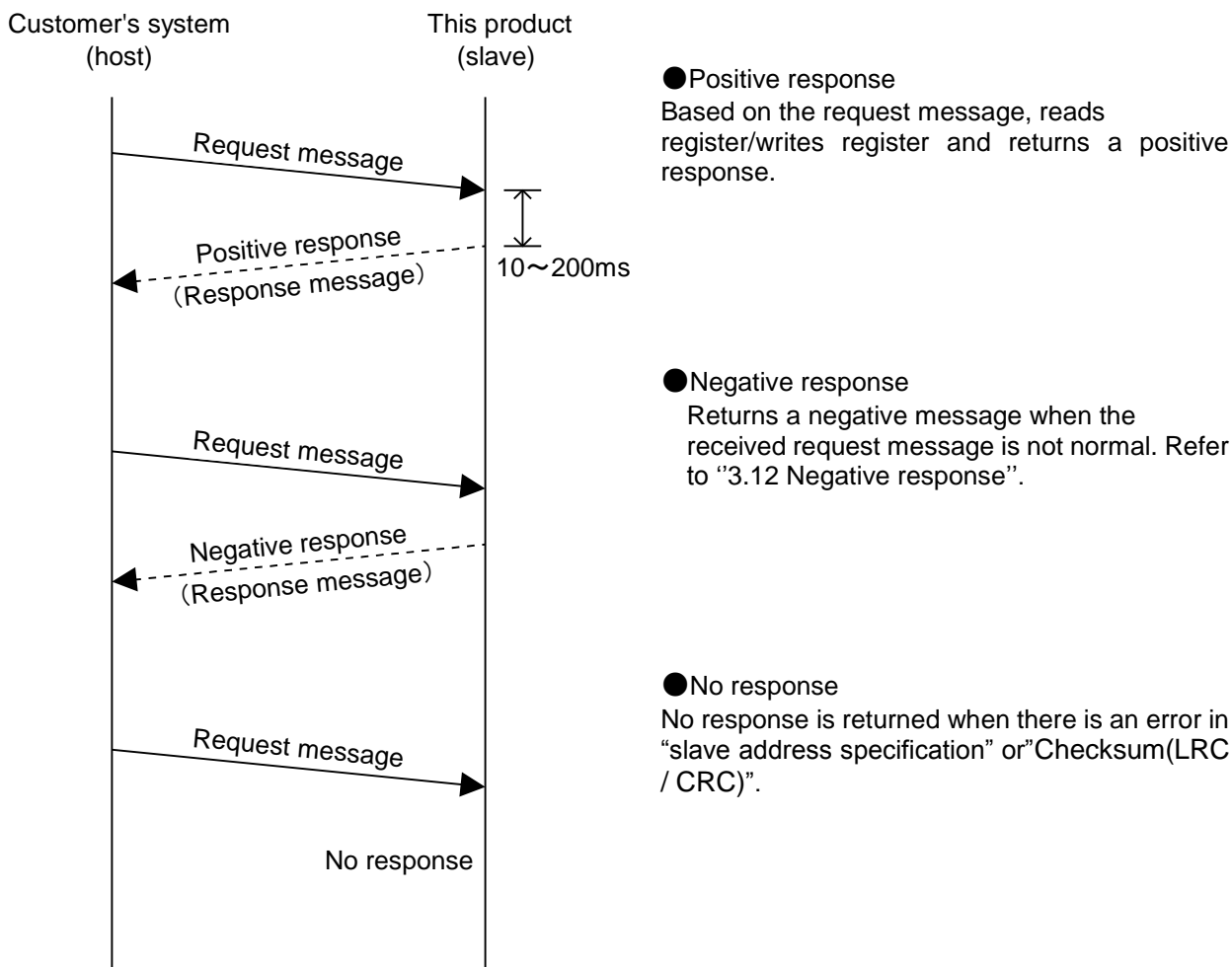

## 3.8 Message configuration

### 3.8.1 Message frame

The message configuration is shown below. The communication of this product uses 2 transmission modes, ASCII or RTU.

1) ASCII mode frame

For ASCII mode, the message starts with ASCII characters “.”(0X3A) and ends with “CR/LF”(0X0D,0X0A). A response message will not be returned unless the request includes [:] and [CR][LF]. This product clears all previously received code when [:] is received.

Table 3.8-1 ASCII mode message frame

| a)Start | b)Slave Address | c)Function | d)Data      | e)Checksum (LRC) | f)End       |
|---------|-----------------|------------|-------------|------------------|-------------|
| [:]     | XX   XX         | XX   XX    | XX   ~   XX | XX   XX          | [CR]   [LF] |

a) Start

The start of the message. [:](3Ah) (ASCII)

b) Slave Address

This is a number to identify this product. “1” is the default setting. This can be changed by the operation display panel.

c) Function (Refer to “3.9 Function codes”)

Command is assigned.

d) Data

Depending on the function, the address and the number of the register, the value of reading/writing are assigned.

e) LRC

LRC method

Refer to “3.10.1 LRC(ASCII)”.

f) END

The end of the message. [CR](0Dh) + [LF](0Ah)

- 2) RTU mode frame  
RTU mode starts from and ends with at least 3.5 characters of silent interval. Silent interval is indicated by T1-T2-T3-T4.

Table 3.8.2 RTU mode message frame

| a)Start     | b)Slave Address | c)Function | d)Data  | e) Checksum (CRC) | f)End       |
|-------------|-----------------|------------|---------|-------------------|-------------|
| T1-T2-T3-T4 | XX              | XX         | XX ~ XX | XX XX             | T1-T2-T3-T4 |

a) Start

In Modbus RTU mode, message frames are separated by a silent interval (non-communication time). At least 3.5 characters of silent interval are necessary at the beginning and the end of the communication frame.

b) Slave Address

This is a number to identify this product. "1" is the default setting. This can be changed by the operation display panel.

c) Function

Command is assigned.

d) Data

Depending on the function, the address and the number of the register, the value of reading/writing are assigned.

e) CRC

CRC method.

Refer to "3.10.2 CRC(RTU)".

f) End

3.5 characters of silent interval indicates the end of a message.

## 3.9 Function codes

Table 3.9-1 shows function codes to read or write register. Refer to "3.11 Explanation of function codes".

Table 3.9-1 Function codes

| NO | Code    | Name                      | Function                           |
|----|---------|---------------------------|------------------------------------|
| 1  | 04(04h) | read holding registers    | Reading multiple registers         |
| 2  | 06(06h) | preset single register    | Writing registers*1                |
| 3  | 16(10h) | preset multiple registers | Writing multiple registers         |
| 4  | 23(17h) | read/write 4x registers   | Reading/writing multiple registers |

\*1: Broadcast is not supported.

## 3.10 Checksum calculation method

### 3.10.1 LRC(ASCII)

LRC checks the content of the message other than [:] of START and [CR][LF] of END. The sending side calculates and sets. The receiving side calculates based on the received message, and compares the calculation result with the received LRC. The received message is deleted if the calculation result and received LRC do not match.

Add up the byte number of the message consisting of 8 consecutive bits. The result except the carry (overflow) is converted to 2's complement.

#### ■ Calculation example

Example) Change circulating fluid set temperature 25.4 ° C

Sending data 0106000B00FE

○Slave Address : No.1

○Function : No.06

○Writing address : 000Bh

○Writing data : 00Feh

| No | Classification              | Contents   | calculation result |
|----|-----------------------------|--|--------------------|
| 1  | LRC message for calculation | 0106000B00FE   | -                  |
| 2  | Calculation                 | Added for each 8Byte<br>01h + 06h + 00h + 0Bh + 00h + FEh = 110h | 10h                |
| 3  |                             | complement of 2<br>10h → EFh → F0h                               | F0h (LRC)          |
| 4  | Sending message             | [:]0106000B00FEF0[CR][LF]  | -                  |

### 3.10.2 CRC(RTU)

CRC checks the content of the message. The sending side calculates the data every 2 bytes (16 bits). The receiving side calculates CRC based on the received message, and compares the calculation result with the received CRC. The received message is deleted if the calculated CRC is different from the received CRC.

#### ■ Calculation procedure

- ① Preload "FFFFh" (set 0xFFFF as initial value ).
- ② Exclusive OR the first byte of the transmitted message with the value in (1).
- ③ Shift the result of (2) by one bit toward the least significant bit, and fill a zero into the most significant bit position.
- ④ If the least significant bit was a 1, exclusive OR the result of (3) with "A001h". (Example 1). If the least significant bit was a 0, no exclusive OR takes place.
- ⑤ Repeat (3) to (5) until eight shifts have been performed.S
- ⑥ After eight shifts, exclusive OR the result of (5) with the next 1-byte (2nd. byte).
- ⑦ The processes (3) to (6) are repeated for all the remaining bytes of the message.
- ⑧ The 2-byte data of the result of (7) is the CRC value.



(Example 1) The least significant bit was a 1.

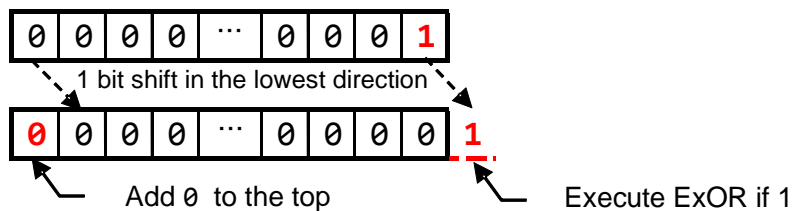

(Example 2) The least significant bit was a 0.

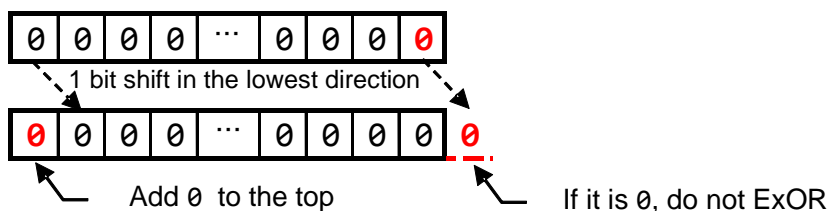

### ■ Calculation example

Example) Change circulating fluid set temperature 25.4 ° C

Sending data 0106000B00FE

○Slave Address : No.1

○Function : No.06

○Writing address : 000Bh

○Writing data : 00FEh

| Aata No.      | 1st value | 2nd value | 3rd value | 4th value | 5th value | 6th value |
|---------------|-----------|-----------|-----------|-----------|-----------|-----------|
| Data contents | 0001h     | 0006h     | 0000h     | 000Bh     | 0000h     | 00FEh     |

| No | Classification               | Contents  | Result      |
|----|------------------------------|---|-------------|
| 1  | CRC message for calculation  | 0106000B00FE  | -           |
| 2  | Calculation                  | Perform (1) to (4) for the 1st value (0001h) and then, perform (5). | 807Eh       |
| 3  |                              | Perform (6) for 2nd value (0006h) and then, perform (5).            | 2280h       |
| 4  |                              | Perform (6) for 3rd. value (0000h) and then, perform (5).           | A023h       |
| 5  |                              | Perform (6) for 4th value (000Bh) and then, perform (5).            | 1EA0h       |
| 6  |                              | Perform (6) for 5th value (0000h) and then, perform (5).            | 781Eh       |
| 7  |                              | Perform (6) for 6th value (00FEh) and then, perform (5).            | 8879h (CRC) |
| 8  | Addition to the sent message | 0106000B00FE7988*1  | -           |

\*1 When incorporating it into the message, set it in order of low byte and high byte.

## 3.11 Explanation of function codes

### 3.11.1 Function code :04 Reading multiple registers

Register data of assigned points from assigned address is read.

#### ■ Communication example

○Slave Address : No.1

○Read seven consecutive data from register 0000h.

(Read circulating fluid discharge temperature、circulating fluid flow rate、circulating fluid discharge pressure、electric conductivity of the circulating fluid、status address information、alarm information)

| Request message 010400000007       |                        |                           |                      |
|------------------------------------|------------------------|---------------------------|----------------------|
| Field name                         | Example (HEX)          | ASCII mode character data | RTU mode binary data |
| Header                             | -                      | “:”                       | None                 |
| Slave Address                      | 0x01                   | “0”, “1”                  | 0x01                 |
| Function                           | 0x04                   | “0”, “4”                  | 0x04                 |
| Head address of specified register | 0x0000                 | “0”, “0”, “0”, “0”        | 0x00, 0x00           |
| Quantity of register to read       | 0x0007                 | “0”, “0”, “0”, “7”        | 0x00, 0x07           |
| Checksum ASCII:LRC RTU:CRC         | -                      | “F”, “4”                  | 0xB1, 0xC8           |
| Trailer                            | -                      | CR/LF                     | None                 |
|                                    | Total quantity of byte | 17                        | 8                    |

| Response message 01040E00D4000000D000002010000000                    |                        |                           |                      |
|--|------------------------|---------------------------|----------------------|
| Field name   | Example (HEX)          | ASCII mode character data | RTU mode binary data |
| Header   | -                      | “:”                       | None                 |
| Slave Address  | 0x01                   | “0”, “1”                  | 0x01                 |
| Function   | 0x04                   | “0”, “4”                  | 0x04                 |
| Quantity of bytes to read  | 0x0E                   | “0”, “E”                  | 0x0E                 |
| Information of 0000h(Circulating fluid discharge temperature)        | 0x00D4                 | “0”, “0”, “D”, “4”        | 0x00, 0xD4           |
| Information of 0001h(Circulating fluid flow rate)                    | 0x0000                 | “0”, “0”, “0”, “0”        | 0x00, 0x00           |
| Information of 0002h(Circulating fluid discharge pressure)           | 0x000D                 | “0”, “0”, “0”, “D”        | 0x00, 0x0D           |
| Information of 0003h(Electric conductivity of the circulating fluid) | 0x0000                 | “0”, “0”, “0”, “0”        | 0x00, 0x00           |
| Information of 0004h (Status flag 1)                                 | 0x0201                 | “0”, “2”, “0”, “1”        | 0x02, 0x01           |
| Information of 0005h (Alarm flag 1)                                  | 0x0000                 | “0”, “0”, “0”, “0”        | 0x00, 0x00           |
| Information of 0006h (Alarm flag 2)                                  | 0x0000                 | “0”, “0”, “0”, “0”        | 0x00, 0x00           |
| Checksum ASCII:LRC RTU:CRC   | -                      | “0”, “9”                  | 0xF8, 0x80           |
| Trailer  | -                      | CR/LF                     | None                 |
|  | Total quantity of byte | 39                        | 19                   |

### 3.11.2 Function code :06 Writing registers

Write data to assigned address.

■ Communication example

○ Slave Address : No.1

○ Write data to register 000Ch

(Commands to run)

| Request message 0106000C0001             |                        |                           |                      |
|--|------------------------|---------------------------|----------------------|
| Field name                               | Example (HEX)          | ASCII mode character data | RTU mode binary data |
| Header                                   | -                      | “:”                       | None                 |
| Slave Address                            | 0x01                   | “0”, “1”                  | 0x01                 |
| Function                                 | 0x06                   | “0”, “6”                  | 0x06                 |
| Head address of specified register       | 0x000C                 | “0”, “0”, “0”, “C”        | 0x00, 0x0C           |
| Information written to 000Ch (Stop flag) | 0x0001                 | “0”, “0”, “0”, “1”        | 0x00, 0x01           |
| Checksum ASCII:LRC RTU:CRC               | -                      | “E”, “C”                  | 0x88, 0x09           |
| Trailer                                  | -                      | CR/LF                     | None                 |
| -  | Total quantity of byte | 17                        | 8                    |

| Response message 0106000C0001    |                        |                           |                      |
|----------------------------------|------------------------|---------------------------|----------------------|
| Field name                       | Example (HEX)          | ASCII mode character data | RTU mode binary data |
| Header                           | -                      | “.”                       | None                 |
| Slave Address                    | 0x01                   | “0”, “1”                  | 0x01                 |
| Function                         | 0x06                   | “0”, “6”                  | 0x06                 |
| Address of register to write     | 0x000C                 | “0”, “0”, “0”, “C”        | 0x00, 0x0C           |
| Information of register to write | 0x0001                 | “0”, “0”, “0”, “1”        | 0x00, 0x01           |
| Checksum ASCII:LRC RTU:CRC       | -                      | “E”, “C”                  | 0x88, 0x09           |
| Trailer                          | -                      | CR/LF                     | None                 |
|                                  | Total quantity of byte | 17                        | 8                    |

### 3.11.3 Function code : 16 Writing multiple registers

Register content of assigned points of assigned address is written.

#### ■ Communication example

○Slave Address No.1

○Write two consecutive data from register 000Bh.

(Commands to change of circulating fluid set temperature <34.9 °C > and run.)

| Request message 0110000B000204015D0001                              |                        |                           |                      |
|---|------------------------|---------------------------|----------------------|
| Field name  | Example (HEX)          | ASCII mode character data | RTU mode binary data |
| Header  | -                      | “.”                       | None                 |
| Slave Address   | 0x01                   | “0”, “1”                  | 0x01                 |
| Function  | 0x10                   | “1”, “0”                  | 0x10                 |
| Head address of specified register                                  | 0x000B                 | “0”, “0”, “0”, “B”        | 0x00, 0x0B           |
| Quantity of register to write                                       | 0x0002                 | “0”, “0”, “0”, “2”        | 0x00, 0x02           |
| Quantity of byte to read  | 0x04                   | “0”, “4”                  | 0x04                 |
| Information written to 000Bh<br>(Circulating fluid set temperature) | 0x015D                 | “0”, “1”, “5”, “D”        | 0x01, 0x5D           |
| Information written to 000Ch<br>(Stop flag)                         | 0x0001                 | “0”, “0”, “0”, “1”        | 0x00, 0x01           |
| Checksum ASCII:LRC RTU:CRC  | -                      | “7”, “F”                  | 0xE3, 0xF2           |
| Trailer   | -                      | CR/LF                     | None                 |
| -   | Total quantity of byte | 27                        | 13                   |

| Response message 0110000B0002     |                        |                           |                      |
|-----------------------------------|------------------------|---------------------------|----------------------|
| Field name                        | Example (HEX)          | ASCII mode character data | RTU mode binary data |
| Header                            | -                      | “.”                       | None                 |
| Slave Address                     | 0x01                   | “0”, “1”                  | 0x01                 |
| Function                          | 0x10                   | “1”, “0”                  | 0x10                 |
| Head address of register to write | 0x000B                 | “0”, “0”, “0”, “B”        | 0x00,0x0B            |
| Quantity of register to write     | 0x0002                 | “0”, “0”, “0”, “2”        | 0x00,0x02            |
| Checksum ASCII:LRC<br>RTU:CRC     | -                      | “E”, “2”                  | 0x30,0x0A            |
| Trailer                           | -                      | CR/LF                     | None                 |
|                                   | Total quantity of byte | 17                        | 8                    |

### 3.11.4 Function code :23 Reading/writing multiple registers

Register content of assigned points of assigned address is read. Write the register data from the specified address with specified points simultaneously.

#### ■ Communication example

○Slave Address : No.1

○Read three consecutive data from register 0004h, and write two consecutive data from register 000Bh.

(Command to change the circulating fluid set temperature to <15.5°C>, and read status and alarm information.)

| Request message 011700040003000B000204009B0001                      |                        |                           |                      |
|---|------------------------|---------------------------|----------------------|
| Field name  | Example (HEX)          | ASCII mode character data | RTU mode binary data |
| Header  | -                      | “.”                       | None                 |
| Slave Address   | 0x01                   | “0”, “1”                  | 0x01                 |
| Function  | 0x17                   | “1”, “7”                  | 0x17                 |
| Head address of specified register                                  | 0x0004                 | “0”, “0”, “0”, “4”        | 0x00,0x04            |
| Quantity of register to read  | 0x0003                 | “0”, “0”, “0”, “3”        | 0x00,0x03            |
| Head address of specified register                                  | 0x000B                 | “0”, “0”, “0”, “B”        | 0x00,0x0B            |
| Quantity of register to write                                       | 0x0002                 | “0”, “0”, “0”, “2”        | 0x00,0x02            |
| Quantity of byte to write   | 0x04                   | “0”, “4”                  | 0x04                 |
| Information written to 000Bh<br>(Circulating fluid set temperature) | 0x009B                 | “0”, “0”, “9”, “B”        | 0x00,0x9B            |
| Information written to 000Ch (Stop flag)                            | 0x0001                 | “0”, “0”, “0”, “1”        | 0x00,0x01            |
| Checksum ASCII:LRC<br>RTU:CRC                                       | -                      | “3”, “4”                  | 0x96,0xD6            |
| Trailer   | -                      | CR/LF                     | None                 |
| -   | Total quantity of byte | 35                        | 17                   |

| Response message 011706000000000000  |                        |                           |                      |
|--------------------------------------|------------------------|---------------------------|----------------------|
| Field name                           | Example (HEX)          | ASCII mode character data | RTU mode binary data |
| Header                               | -                      | “.”                       | None                 |
| Slave Address                        | 0x01                   | “0”, “1”                  | 0x01                 |
| Function                             | 0x17                   | “1”, “7”                  | 0x17                 |
| Quantity of bytes to read            | 0x06                   | “0”, “6”                  | 0x06                 |
| Information of 0004h (Status flag 1) | 0x0000                 | “0”, “0”, “0”, “0”        | 0x00, 0x00           |
| Information of 0005h (Alarm flag 1)  | 0x0000                 | “0”, “0”, “0”, “0”        | 0x00, 0x00           |
| Information of 0006h (Alarm flag 2)  | 0x0000                 | “0”, “0”, “0”, “0”        | 0x00, 0x00           |
| Checksum ASCII:LRC RTU:CRC           | -                      | “E”, “2”                  | 0x21, 0x8A           |
| Trailer                              | -                      | CR/LF                     | None                 |
|                                      | Total quantity of byte | 23                        | 11                   |

### 3.12 Negative response

A negative response is returned when the following request message is received.

- 1) When unspecified function code is used.
- 2) An address out of range is specified.
- 3) The data field is not normal.

■ **Negative response message (Slave to Master)**

1) Negative acknowledgment message frame in ASCII mode.

| Start | Slave Address |    | 1)Function |    | 2)Error Code |    | LRC |    | End  |      |
|-------|---------------|----|------------|----|--------------|----|-----|----|------|------|
| [:]   | XX            | XX | XX         | XX | XX           | XX | XX  | XX | [CR] | [LF] |

2) Negative acknowledgment message frame in RTU.

| Start             | Slave Address |    | 1)Function |    | 2)Error Code |    | CRC |    | End               |  |
|-------------------|---------------|----|------------|----|--------------|----|-----|----|-------------------|--|
| T1-T2-T3-T4<br>*1 | XX            | XX | XX         | XX | XX           | XX | XX  | XX | T1-T2-T3-T4<br>*1 |  |

**\* 1 Silent interval for 3.5 characters**

1) Function

Assign the value consisting of the request function code (hexadecimal value) plus 80h.

Example 1) ASCII mode

Received function code: “04”(0000 0100)” ASCII code 30h, 34h  
 Abnormal function code: “84”(1000 0100)” ASCII code 38h, 34h

Example 2) RTU mode

Receive function code: "04" (0000 0100)  
 Abnormal function code: "84" (1000 0100)

2) Error Code

Assign error code below.

- 01 : Function code of a command is outside the standard
- 02 : The specified address of register is outside the range.
- 03 : Data field of a command is not normal.

■ **Communication example**

- Slave Address: No 1
- Read seven consecutive data from register 0100h which is out of range.

| Request message 010401000007          |                        |                           |                      |
|---------------------------------------|------------------------|---------------------------|----------------------|
| Field name                            | Example (HEX)          | ASCII mode character data | RTU mode binary data |
| Header                                | -                      | “.”                       | None                 |
| Slave Address                         | 0x01                   | “0”, “1”                  | 0x01                 |
| Function                              | 0x04                   | “0”, “4”                  | 0x04                 |
| Head address of register out of range | 0x0100                 | “0”, “1”, “0”, “0”        | 0x01, 0x00           |
| Quantity of register to read          | 0x0007                 | “0”, “0”, “0”, “7”        | 0x00, 0x07           |
| Checksum ASCII:LRC RTU:CRC            | -                      | “F”, “3”                  | 0xB0, 0x34           |
| Trailer                               | -                      | CR/LF                     | None                 |
| -                                     | Total quantity of byte | 16                        | 8                    |

| Response message 018402                                     |                        |                           |                      |
|---|------------------------|---------------------------|----------------------|
| Field name  | Example (HEX)          | ASCII mode character data | RTU mode binary data |
| Header  | -                      | “.”                       | None                 |
| Slave Address   | 0x01                   | “0”, “1”                  | 0x01                 |
| Function (03h+80h)  | 0x84                   | “8”, “4”                  | 0x84                 |
| Error Code<br>(Specified register address is out of range.) | 0x02                   | “0”, “2”                  | 0x02                 |
| Checksum ASCII:LRC RTU:CRC                                  | -                      | “7”, “9”                  | 0xC2, 0xC1           |
| Trailer   | -                      | CR/LF                     | None                 |
| -   | Total quantity of byte | 11                        | 5                    |

### 3.13 Register Map

| Address | Bit Format  |    |    |    |    |    |   |   |                                   |              |          |    |   |   |   |   | R/W |     |
|---------|---|----|----|----|----|----|---|---|-----------------------------------|--------------|----------|----|---|---|---|---|-----|-----|
|         | 15  | 14 | 13 | 12 | 11 | 10 | 9 | 8 | 7                                 | 6            | 5        | 4  | 3 | 2 | 1 | 0 |     |     |
| 0000h   | Circulating fluid discharge temperature<br>-327.6 to 327.6°C = F334h to 0CCCh(0.1°C/dig)<br>(Refer to 3.13.1 Circulating fluid discharge temperature)                       |    |    |    |    |    |   |   |                                   |              |          |    |   |   |   |   | R   |     |
| 0001h   | Circulating fluid flow rate<br>-3276.8 to 3276.7LPM = 8000h to 7FFFh(0.1LPM/dig)<br>(Refer to 3.13.2 Circulating fluid flow rate)   |    |    |    |    |    |   |   |                                   |              |          |    |   |   |   |   |     |     |
| 0002h   | Circulating fluid discharge pressure<br>-32.768 to 32.767MPa = 8000h to 7FFFh(0.0001MPa/dig)<br>(Refer to 3.13.3 Circulating fluid discharge pressure)                      |    |    |    |    |    |   |   |                                   |              |          |    |   |   |   |   |     |     |
| 0003h   | Electric conductivity of the circulating fluid<br>-3276.8 to 3276.7μS/cm = 8000 to 7FFFh (0.1μS/cm/dig)<br>(Refer to 3.13.4 Electric conductivity of the circulating fluid) |    |    |    |    |    |   |   |                                   |              |          |    |   |   |   |   |     |     |
| 0004h   | Status flag 1 (Refer to 3.13.5 Status flag 1)   |    |    |    |    |    |   |   |                                   |              |          |    |   |   |   |   |     |     |
| 0005h   | Alarm flag 1 (Refer to 3.13.6 Alarm flag)   |    |    |    |    |    |   |   |                                   |              |          |    |   |   |   |   |     |     |
| 0006h   | Alarm flag 2 (Refer to 3.13.6 Alarm flag)   |    |    |    |    |    |   |   |                                   |              |          |    |   |   |   |   |     |     |
| 0007h   | None  |    |    |    |    |    |   |   |                                   |              |          |    |   |   |   |   |     |     |
| 0008h   | Data instruction information 2 *1   |    |    |    |    |    |   |   | Data instruction information 1 *1 |              |          |    |   |   |   |   |     |     |
| 0009h   | Data display 1(Refer to 3.13.8 Data display)  |    |    |    |    |    |   |   |                                   |              |          |    |   |   |   |   |     |     |
| 000Ah   | Data display 2(Refer to 3.13.8 Data display)  |    |    |    |    |    |   |   |                                   |              |          |    |   |   |   |   |     |     |
| 000Bh   | Circulating fluid set temperature<br>-3276.8 to 3276.7°C = 8000h to 7FFFh (0.1°C/dig)<br>(Refer to 3.13.9 Circulating fluid set temperature)                                |    |    |    |    |    |   |   |                                   |              |          |    |   |   |   |   |     | R/W |
| 000Ch   | None  |    |    |    |    |    |   |   | *3                                | Reserv<br>ed | No<br>ne | *2 |   |   |   |   |     |     |
| 000Dh   | None  |    |    |    |    |    |   |   |                                   |              |          |    |   |   |   |   |     |     |
| 000Eh   | None  |    |    |    |    |    |   |   |                                   |              |          |    |   |   |   |   |     |     |
| 000Fh   | Data instruction 2 *4   |    |    |    |    |    |   |   | Data instruction1 *4              |              |          |    |   |   |   |   |     |     |

- \*1 Data instruction information (Refer to 3.13.7 Data instruction information)
- \*2 Operation Start Command (Refer to 3.13.10 Operation Start Command)
- \*3 Serial remote instruction (Refer to 3.13.11 Serial remote instruction)
- \*4 Data instruction (Refer to 3.13.12 Data instruction)



### 3.13.1 Circulating fluid discharge temperature

Read the circulating fluid discharge temperature in the selected temperature unit (°C or °F). Read the circulating fluid discharge temperature which is displayed on the operation display panel. (Offset temperature is displayed if offset function is set).

### 3.13.2 Circulating fluid flow rate

Read the circulating fluid flow rate in the selected pressure unit.

### 3.13.3 Circulating fluid discharge pressur

Read the circulating fluid discharge pressure in the selected pressure unit.

### 3.13.4 Electric conductivity of the circulating fluid

Electric conductivity of the circulating fluid is informed.  
0 is announced when option-DM is not selected.

### 3.13.5 Status flag

The status of the product is read by the following assignment.

#### Status flag

|      |             |    |    |    |    |    |   |   |   |   |   |   |   |   |   |   |
|------|-------------|----|----|----|----|----|---|---|---|---|---|---|---|---|---|---|
| Name | Status flag |    |    |    |    |    |   |   |   |   |   |   |   |   |   |   |
| Bit  | 15          | 14 | 13 | 12 | 11 | 10 | 9 | 8 | 7 | 6 | 5 | 4 | 3 | 2 | 1 | 0 |

| Bit | Name   | Explanation  |
|-----|--|--|
| 0   | Run flag                                     | Run status 0= Stop 1= Run  |
| 1   | Operation stop alarm flag                    | Operation stop alarm given off status<br>0= Not occurred 1= Operation stop alarm given off                     |
| 2   | Operation continued alarm flag               | Operation continued alarm given off status<br>0= Not occurred 1= Operation continued alarm given off           |
| 3   | Unused                                       | —  |
| 4   | Unused                                       | —  |
| 5   | Remote status flag                           | Remote status<br>0= Other than SERIAL mode 1= SERIAL mode  |
| 6   | Unused                                       | —  |
| 7   | Unused                                       | —  |
| 8   | Unused                                       | —  |
| 9   | Completion of preparation (TEMP READY) flag  | Completion of preparation (TEMP READY) status<br>0= Condition isn't formed 1= Condition is formed              |
| 10  | Temperature range monitoring (TEMP OUT) flag | Temperature range monitoring(TEMP OUT) status<br>0= Condition is not established<br>1=Condition is established |
| 11  | Notice for maintenance                       | Notice for maintenance status<br>0 = Not generated 1 = Generated   |
| 12  | Unused                                       | —  |
| 13  | Unused                                       | —  |
| 14  | Unused                                       | —  |
| 15  | Unused                                       | —  |

### 3.13.6 Alarm flag

Each type of alarm which occurs in the product is read with the following assignment.

|      |              |    |    |    |    |    |   |   |   |   |   |   |   |   |   |   |
|------|--------------|----|----|----|----|----|---|---|---|---|---|---|---|---|---|---|
| Name | Alarm flag 1 |    |    |    |    |    |   |   |   |   |   |   |   |   |   |   |
| Bit  | 15           | 14 | 13 | 12 | 11 | 10 | 9 | 8 | 7 | 6 | 5 | 4 | 3 | 2 | 1 | 0 |

|      |              |    |    |    |    |    |   |   |   |   |   |   |   |   |   |   |
|------|--------------|----|----|----|----|----|---|---|---|---|---|---|---|---|---|---|
| Name | Alarm flag 2 |    |    |    |    |    |   |   |   |   |   |   |   |   |   |   |
| Bit  | 15           | 14 | 13 | 12 | 11 | 10 | 9 | 8 | 7 | 6 | 5 | 4 | 3 | 2 | 1 | 0 |

| Bit          | Name                            | Explanation                                      |  |
|--------------|---------------------------------|--|--|
| Alarm flag 1 | 0                               | AL01 : Tank level drop abnormality               | Alarm given off status<br>0= Not occurred<br>1= Occurred |
|              | 1                               | AL02 : Low level in tank                         |  |
|              | 2                               | Unused   |  |
|              | 3                               | AL04 : Water leakage                             |  |
|              | 4                               | AL05 : Pump inverter error *1                    |  |
|              | 5                               | AL06 : Internal fan stop *2                      |  |
|              | 6                               | Unused   |  |
|              | 7                               | Unused   |  |
|              | 8                               | AL09 : Circulating fluid discharge pressure rise |  |
|              | 9                               | AL10 : Flow rate decreased                       |  |
|              | 10                              | AL11 : Ambient temperature is out of the range   |  |
|              | 11                              | AL12 : Electric conductivity increase            |  |
|              | 12                              | AL13 : NOT TEMP READY                            |  |
|              | 13                              | AL14 : Circulating fluid temperature increase    |  |
|              | 14                              | AL15 : Circulating fluid temperature decrease    |  |
| 15           | Unused                          |  |  |
| Alarm flag 2 | 0                               | AL17 : Low flow rate                             |  |
|              | 1                               | AL18 : High circulating fluid discharge temp.    |  |
|              | 2                               | AL19 : High circulating fluid return temp.       |  |
|              | 3                               | Unused   |  |
|              | 4                               | AL21 : High circulating fluid discharge pressure |  |
|              | 5                               | AL22 : Low circulating fluid discharge pressure  |  |
|              | 6                               | Unused   |  |
|              | 7                               | AL24 : Memory error                              |  |
|              | 8                               | AL25 : Contact input1                            |  |
|              | 9                               | AL26 : Signal detection                          |  |
|              | 10                              | AL27 : Contact input 2                           |  |
|              | 11                              | AL28 : Signal detection                          |  |
|              | 12                              | AL29 : Forced stop                               |  |
|              | 13                              | AL30 : Notice for maintenance                    |  |
|              | 14                              | AL31 : Communication error                       |  |
| 15           | AL32 : Compressor circuit error |  |  |

\*1 For HRR010-AW\*-20-T1\*

\*2 For HRR010/050-W water-cooled type

### 3.13.7 Data instruction information

Instruction information set in the Data instruction is displayed. Refer to 3.13.12 "Data Instruction" for details.

### 3.13.8 Data display

The content selected for the Data instruction is displayed in Data display 1 and Data display 2. Table below shows the data type which can be displayed and the range.

| No. | Item                                | Range                                   |
|-----|-------------------------------------|---|
| 1   | TH1(circulating fluid return temp.) | -327.6~327.6°C = F334h~0CCCh(0.1°C/dig) |

### 3.13.9 Circulating fluid set temperature

The circulating fluid set temperature can be set during SERIAL mode.

If the temperature exceeds the upper limit of the circulating fluid set temperature range, the circulating fluid set temperature is changed to the upper limit value. If it is lower than the lower limit, the circulating fluid set temperature is changed to the lower limit value.

### 3.13.10 Operation Start Command

The operation can be controlled by sending the operation start command during SERIAL mode.

0=Run stop    1=Run start

### 3.13.11 Serial remote instruction

Operation mode can be switched to SERIAL mode during LOCAL mode or DIO mode by enabling/ disabling the communication mode and serial communication mode.

0:None, 1:LOCAL/DIO mode, 3:SERIAL mode

|         |   |   |   |
|---------|---|---|---|
| {       | 4th bit   | 0= Communication mode cannot be switched<br>1= Communication mode can be switched | } |
| 5th bit | 0=Serial communication mode disabled<br>1=Serial communication mode enabled |   |   |

Example 1) Switch the SERIAL mode

Enable serial communication mode with communication mode switching enabled. Set a 1 to the 4th and 5th bit of address 000Ch.

Example 2) Switch the LOCAL/ DIO mode

Disables serial communication mode and enables the communication mode. Set a 1 to the 4th bit and set a 0 to the 5th bit of address 000Ch.

### 3.13.12 Data instruction

Selected data is displayed in the address 0009h (Data display 1) and 0010h (Data display 2) by setting the Data instruction.

Data types which can be displayed are shown below. Data display 1 shows the data instructed by the Data instruction 1 (instructed by low order 8 bits).

Data display 2 shows the data instructed by the Data instruction 2 (instructed by high order 8 bits).

|                    |    |    |    |    |    |   |   |                    |   |   |   |   |   |   |   |
|--------------------|----|----|----|----|----|---|---|--------------------|---|---|---|---|---|---|---|
| MSB                |    |    |    |    |    |   |   | LSB                |   |   |   |   |   |   |   |
| 15                 | 14 | 13 | 12 | 11 | 10 | 9 | 8 | 7                  | 6 | 5 | 4 | 3 | 2 | 1 | 0 |
| Data instruction 2 |    |    |    |    |    |   |   | Data instruction 1 |   |   |   |   |   |   |   |

Bit 7 to 0: Data instruction 1

0: None

1: TH1(circulating fluid return temp)

Bit 15 to 8: Data instruction 2

0: None

1: TH1(circulating fluid return temp)

Example) Display the circulating fluid return temperature

When 0001h is entered to the address 000F, the circulating fluid return temperature is displayed in 0009h.

#### ■ Communication example

○When reading the circulating fluid return temp to the data display 1

○Slave Address: No.1

○Function code 23: One data of 0009h is read and one data is written to 000Fh

(Set circulating fluid return temperature to data instruction 1. Read circulating fluid return temp of data display 1.)

| Request message 011700090001000F0001020001      |                        |                           |                      |
|---|------------------------|---------------------------|----------------------|
| Field name                                      | Example (HEX)          | ASCII mode character data | RTU mode binary data |
| Header  | -                      | “:”                       | None                 |
| Slave Address                                   | 0x01                   | “0”, “1”                  | 0x01                 |
| Function  | 0x17                   | “1”, “7”                  | 0x17                 |
| Head address of specified register              | 0x0009                 | “0”, “0”, “0”, “9”        | 0x00, 0x09           |
| Head address of specified register              | 0x0001                 | “0”, “0”, “0”, “1”        | 0x00, 0x01           |
| Head address of specified register              | 0x000F                 | “0”, “0”, “0”, “F”        | 0x00, 0x0F           |
| Quantity of register to write                   | 0x0001                 | “0”, “0”, “0”, “1”        | 0x00, 0x01           |
| Quantity of byte to read                        | 0x02                   | “0”, “2”                  | 0x02                 |
| Information written to 000Fh (Data instruction) | 0x0001                 | “0”, “0”, “0”, “1”        | 0x00, 0x01           |
| Checksum ASCII:LRC RTU:CRC                      | -                      | “C”, “B”                  | 0x45, 0xBE           |
| Trailer   | -                      | CR/LF                     | None                 |
| -   | Total quantity of byte | 31                        | 15                   |

| Response message 01170200C8                              |                        |                           |                      |
|--|------------------------|---------------------------|----------------------|
| Field name   | Example (HEX)          | ASCII mode character data | RTU mode binary data |
| Header   | -                      | “:”                       | None                 |
| Slave Address  | 0x01                   | “0”, “1”                  | 0x01                 |
| Function   | 0x17                   | “1”, “7”                  | 0x17                 |
| Quantity of byte to read                                 | 0x02                   | “0”, “2”                  | 0x02                 |
| Information of 0009 (TH1(Circulating fluid return temp)) | 0x00C8                 | “0”, “0”, “C”, “8”        | 0x00, 0xC8           |
| Checksum ASCII:LRC RTU:CRC                               | -                      | “1”, “E”                  | 0xBC, 0x22           |
| Trailer  | -                      | CR/LF                     | None                 |
|  | Total quantity of byte | 15                        | 7                    |



# Chapter 4 Communication alarm function

Monitors whether the serial communication is sent/received properly between the product and the customer's device. This feature is only valid when the communication mode is set to SERIAL mode.

Abnormal signals or disconnection of the communication cable can be notified immediately by setting the alarm function to match the interval at which messages are sent from the customer device. When the communication is restored, the alarm is automatically reset.

Do not use this function when the customer device does not send messages regularly.

## 4.1 Communication alarm occurs

Fig 4.1-1 shows when an alarm occurs. Refer to 4.3 "Setting and checking" for the setting method.

- Changing of communication error
  - Operation continues when an alarm occurs.
- Time for monitoring the communication error
  - 180 sec

When the customer's device is sending messages every 60sec, if the communication cable is disconnected and no message is received for 180sec, the product generates AL29 communication error alarm to notify the error.

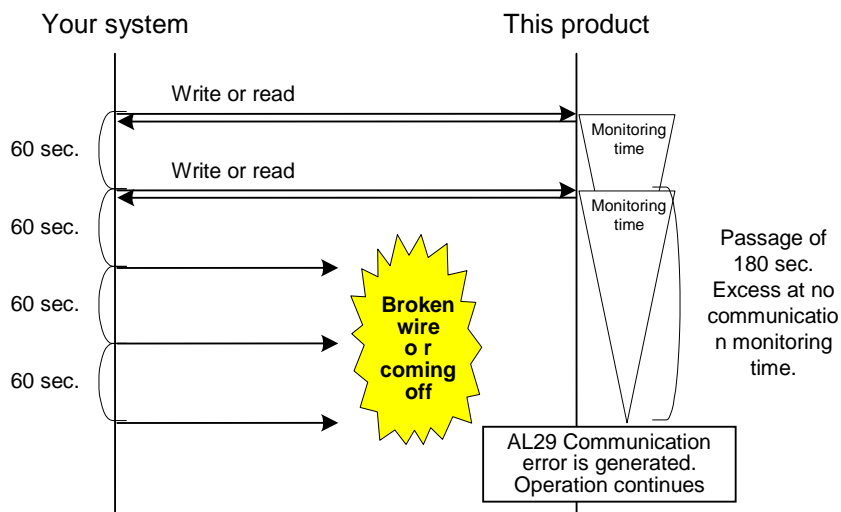

Fig 4.1-1 Communication alarm example

## 4.2 Communication alarm reset

When AL29 communication error has been generated, the alarm is automatically reset when the disconnection of the communication cable is fixed, and the message from the customer is received. If operation is set to stop when a communication alarm occurs, restart the operation if necessary.

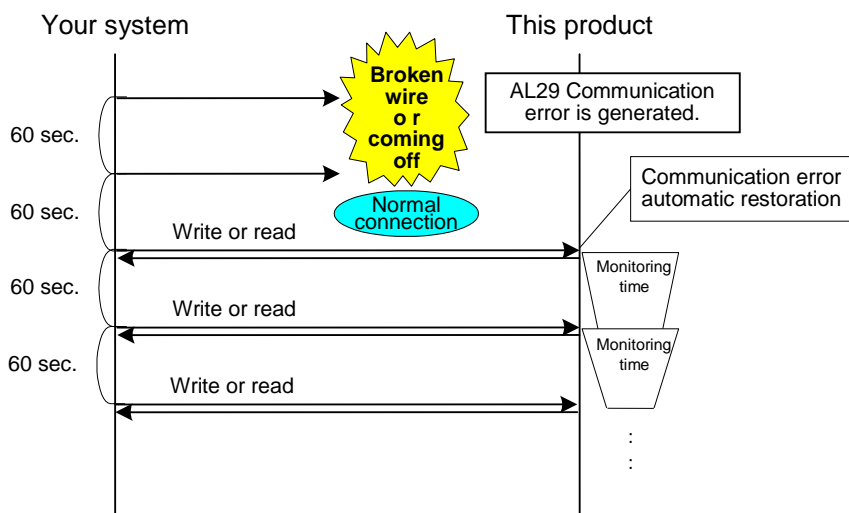

Fig 4.2-1 Communication alarm restoration example

## 4.3 Setting and checking

### 4.3.1 Setting and checking items

The table below explains the setting items of the communication alarm function and default values.

Table 4.3-1 Communication error setting item

| Screen No.   | Item   | Display unit        |                      |                     | Unit display | Contents   |
|--------------|--|---------------------|----------------------|---------------------|--------------|--|
|              |  | Upper stage (White) |                      | Lower stage (Green) |              |  |
|              |  | Initial value       | Select/setting range |                     |              |  |
| TOP screen   | —  | AL.ST               | —                    | MENU                | —            | —  |
| No.24 screen | Changing of「AL29: Communication error alarm」         | WRN                 | OFF/WRN/FLT          | COMM⇒ALARM          | —            | Set the operation when "AL29: Communication error alarm" is generated.   |
| No.25 screen | Detection time for 「AL29: Communication error alarm」 | 30                  | 1~600                | COMM⇒TIME           | SEC          | Set the alarm monitoring time when "AL29: Communication error alarm" is generated. Alarm signal is generated when the monitoring time is exceeded. |



### 4.3.2 Setting and checking

Alarm setting menu Top page

1. Displays Communication Setting Menu.

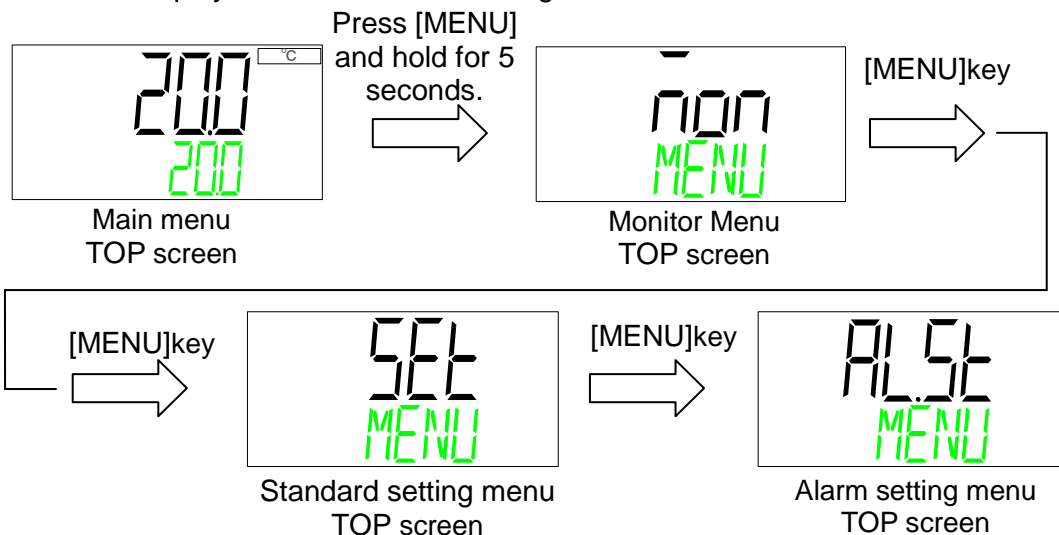

Switching of communication error alarm

2. Press the [▼] key. Displays screen for setting the communication error alarm operation.

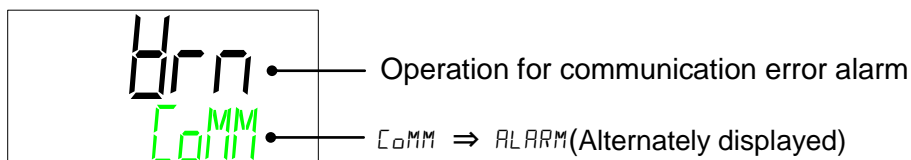

Operation for alarm AL29: Communication error can be selected.

| Set value | Contents   | Initial value |
|-----------|--|---------------|
| oFF       | Alarm is not generated.  | —             |
| brn       | Operation of this product will continue when the alarm occurs. | ○             |
| FLt       | Operation of this product will stop when the alarm occurs.     | —             |

Communication error alarm detection time

---

- 3.** Press the [▼] key. Displays screen for setting the communication error alarm detection time.

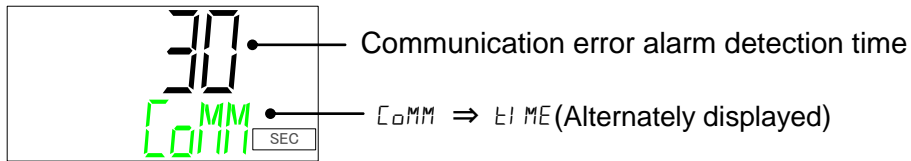

Time (sec.) to generate alarm AL29: Communication error can be changed.  
•Setting range: 1 to 600sec. (Initial value: 30sec.)



| Revision            |
|---------------------|
| Rev D : [June 2020] |

# SMC Corporation

4-14-1, Sotokanda, Chiyoda-ku, Tokyo 101-0021 JAPAN

Tel: + 81 3 5207 8249 Fax: +81 3 5298 5362

URL <http://www.smcworld.com>

---

Note: Specifications are subject to change without prior notice and any obligation on the part of the manufacturer.

© 2020 SMC Corporation All Rights Reserved