



Operation Manual

Product name

Flow Monitor

MODEL/ Series/ Product Number

LFE0###

SMC Corporation



Contents

Safety Instructions	2
Model Indication Method	9
Summary of product parts	12
Definitions and terminology	13
Mounting and Installation	15
Installation	15
Wiring	16
Flow Setting	20
Function Settings	22
Default Setting	22
F0 Selection of sensor	24
F1 Setting of OUT1	25
F2 Setting of OUT2	33
F3 Response Time Setting	39
F10 Selection of display of sub screen	40
F20 Setting of external input	44
F22 Setting of analog output	45
F30 Storing of accumulated flow	47
F80 Setting of Power Saving Mode	48
F81 Setting of Security Code	49
F82 Input of Line Names	50
F90 Settings of All Functions	51
F96 Input value check	52
F97 Selection of copy function	53
F98 Output check	56
F99 Reset to the default settings	57
Other Settings	58
Maintenance	60
Troubleshooting	61
Specification	64
Specifications	64
Dimensions	67



Safety Instructions

These safety instructions are intended to prevent hazardous situations and/or equipment damage. These instructions are categorized into three groups, "Caution", "Warning" and "Danger" depending on the level of hazard and damage, and the degree of emergency. They are all important notes for safety and must be followed in addition to International Standards (ISO/ IEC), Japan Industrial Standards (JIS)^{*1)} and other safety regulations^{*2)}.

*1) ISO 4414: Pneumatic fluid power -- General rules relating to systems.

ISO 4413: Hydraulic fluid power -- General rules relating to systems.

IEC 60204-1: Safety of machinery -- Electrical equipment of machines. (Part 1: General requirements)

ISO 10218-1992: Manipulating industrial robots-Safety.

JIS B 8370: General Rules for Pneumatic Equipment

JIS B 8361: Hydraulic fluid power - General rules relating to systems

JIS B 9960-1: Safety of machinery - Electrical equipment of machines (Part 1: General requirements)

JIS B 8433-1993: Manipulating industrial robots - Safety, etc

*2) Labor Safety and Sanitation Law, etc.

	Caution	Caution indicates a hazard with a low level of risk. Which if not avoided, could result in minor or moderate injury.
	Warning	Warning indicates a hazard with a medium level of risk. Which if not avoided, could result in death or serious injury.
	Danger	Danger indicates a hazard with a high level of risk. Which if not avoided, will result in death or serious injury.

Warning

1. The compatibility of the product is the responsibility of the person who designs the equipment or decides its specifications.

Since the product specified here is used under various operating conditions, its compatibility with specific equipment must be decided by the person who designs the equipment or decides its specifications based on necessary analysis and test results.

The expected performance and safety assurance of the equipment will be the responsibility of the person who has determined its compatibility with the product.

This person should also continuously review all specifications of the product referring to its latest catalog information, with a view to giving due consideration to any possibility of equipment failure when configuring the equipment.

2. Only personnel with appropriate training should operate machinery and equipment.

The product specified here may become unsafe if handled incorrectly.

An operator who is appropriately trained and experienced must perform the assembly, operation and maintenance of machines or equipment.

3. Do not service or attempt to remove product and machinery/equipment until safety is confirmed.

1. The inspection and maintenance of machinery/equipment should only be performed after measures to prevent dropping of driven objects or run-away of machinery/equipment have been confirmed.

2. When the product is to be removed, confirm that the safety measures as mentioned above are implemented and the power from any appropriate source is cut, and read and understand the specific product precautions of all relevant products carefully.

3. Before machinery/equipment is restarted, take measures to prevent unexpected operation and malfunction.

4. Contact SMC beforehand and take special consideration of safety measures if the product is to be used in any of the following conditions.

1. Conditions and environments outside of the given specifications, or used outdoors or in a location exposed to direct sunlight.

2. Installation of equipment in conjunction with atomic energy, railways, air navigation, space, shipping, vehicles, military, medical treatment, combustion and recreation, or equipment in contact with food and beverages, emergency stop circuits, clutch and brake circuits in press applications, safety equipment or other applications unsuitable for the standard specifications described in the product catalog.

3. An application that could have negative effects on people, property, or animals requiring special safety analysis.

4. Use in an interlock circuit, which requires the provision of double interlock for possible failure by using a mechanical protective function, and periodical checks to confirm proper operation. Check the product regularly in order to confirm normal operation.



Safety Instructions

Caution

The product is provided for use in manufacturing industries.

The product herein described is basically provided for use in manufacturing industries.

If the product is being considered for use in other industries, consult SMC beforehand and exchange specifications or a contract if necessary.

If anything is unclear, contact your nearest sales branch.

Limited Warranty and Disclaimer/ Compliance Requirements

The product used is subject to the following "Limited warranty and Disclaimer" and "Compliance Requirements". Read and accept them before using the product.

[Limited Warranty and Disclaimer]

1. The warranty period of the product is 1 year in service or within 1.5 years after the product is delivered. ^{*3)}

Also, the product may have specified durability, running distance or replacement parts. Please consult your nearest sales branch.

2. For any failure or damage reported within the warranty period, which is clearly our responsibility, a replacement product or necessary parts will be provided.

This limited warranty applies only to the SMC product independently, and not to any other damage incurred due to the failure of the product.

3. Prior to using SMC products, please read and understand the warranty terms and disclaimers noted in the specified catalog for the particular products.

^{*3)} Vacuum pads are excluded from this 1 year warranty.



A vacuum pad is a consumable part, so it is warranted for a year after it is delivered.

Also, even within the warranty period, the wear of a product due to the use of the vacuum pad or failure due to the deterioration of rubber material are not covered by the limited warranty.

[Compliance Requirements]

When the product is exported, strictly follow the laws required by the Ministry of Economy, Trade and Industry (Foreign Exchange and Foreign Trade Control Law).









■ Explanation of Symbols

Symbol	Definition
	Things you must not do. Instructions are provided as a drawing or sentence next to the symbol.
	Things you must do Instructions are provided as a drawing or sentence next to the symbol.



■ Operator

<p>(1) This Operation Manual is intended for those who have knowledge of machinery using pneumatic equipment, and have sufficient knowledge of assembly, operation and maintenance of such equipment. Only those persons are allowed to perform assembly, operation and maintenance.</p> <p>(2) Read and understand this Operation Manual carefully before assembling, operating or providing maintenance to the product.</p>

■ Safety Instructions

 Warning	
 Disassembly prohibited	<ul style="list-style-type: none"> ■ Do not disassemble, modify (including the replacement of board) or repair. Otherwise, an injury or failure can result.
 Do not	<ul style="list-style-type: none"> ■ Do not operate the product outside of the specifications. Do not use for flammable or harmful fluids. Fire, malfunction, or damage to the product can result. Please check the specifications before use.
 Do not	<ul style="list-style-type: none"> ■ Do not use in an atmosphere containing flammable or explosive gases. Fire or an explosion can result. The product is not designed to be explosion proof.
 Do not	<ul style="list-style-type: none"> ■ Do not use the product for flammable or highly permeable fluids. Fire, explosion, breakage or corrosion can result.
 Do not	<ul style="list-style-type: none"> ■ Do not use the product in a place where static electricity is a problem. Otherwise failure or malfunction of the system can result.
 Instruction	<ul style="list-style-type: none"> ■ If using the product in an interlocking circuit <ul style="list-style-type: none"> - Provide a double interlocking system, for example a mechanical system. - Check the product for proper operation. Otherwise malfunction can result, causing an accident.
 Instruction	<ul style="list-style-type: none"> ■ The following instructions must be followed during maintenance <ul style="list-style-type: none"> - Turn off the power supply - Stop supplying fluid before maintenance. It may cause an injury.

⚠ Caution

 Do not touch	<ul style="list-style-type: none"> ■ Do not touch the terminals and connectors while the power is on. Otherwise electric shock, malfunction or damage to the switch can result.
 Do not touch	<ul style="list-style-type: none"> ■ Do not touch the piping joint or piping when hot fluid is used. It may lead to burn. Check that the piping is cooled down before touching it.
 Instruction	<ul style="list-style-type: none"> ■ After maintenance is complete, perform appropriate functional inspections and leak test. <ul style="list-style-type: none"> Stop operation if the equipment does not function properly or there is leakage of fluid. When leakage occurs from parts other than the piping, the product itself may be damaged. Cut off the power supply and stop the fluid supply. Do not apply fluid if the system is leaking. Safety cannot be assured in the case of unexpected malfunction.

■ Handling Precautions

- Follow the instructions given below for selecting and handling.



- The instructions on design and selection (installation, wiring, environment, adjustment, operation, maintenance, etc.) described below must be followed.

*Product specifications

Use the UL-certified products below for combined direct current power supply.

Circuit (class 2) of maximum 30vrms (42.4V peak) or less, with UL 1310 class 2 power supply unit or UL 1585 class 2 transformer.

Circuit of (42.4[V peak]) or less (Class 2)

- The product is a  approved product only if it has a  UL mark on the product body and name plate.

- Use the specified voltage.

Otherwise failure or malfunction can result.

Insufficient supply voltage may not drive a load due to a voltage drop inside the product.

Verify the operating voltage of the load before use.

Do not exceed the specified maximum allowable load.

This may cause damage or shorten the lifetime of the product.

Data stored by the product is not deleted, even if the power supply is cut off. (Write limit: 1000000 cycles, Data duration: 20 years after power off.)

- Reserve a space for maintenance.

When designing an application, allow sufficient clearance for maintenance and inspection.

- Product handling

- *Installation

- Tighten to the specified tightening torque.

- If the tightening torque is exceeded, the mounting screws and brackets may be damaged. Insufficient torque can cause displacement of the product from its proper position and the looseness of the mounting screws.

- (Refer to Mounting and Installation (page 15.))

- If a commercially available switching power supply is used, be sure to ground the frame ground (FG) terminal.

- Do not use where the product is subjected to vibration or impact.

- Otherwise damage to the internal components may result, causing malfunction.

- Do not pull the lead wire forcefully, or lift the product by the lead wire. (Tensile strength 30 N or less)

- Hold the product body when handling to prevent damage, failure or malfunction.

- The product will be damaged, leading to failure and malfunction.

- Never mount the product in a place that will be used as a scaffold during piping.

- The product may be damaged if excessive force is applied by stepping or climbing onto it.

- *Wiring (Including connecting/disconnecting of the connectors)

- Do not pull hard on the lead wire, or lift the product by holding the lead wires (Tensile strength 49 N or less).

- Do not carry the product by pulling the lead wire.

- Damage to the connector, circuit board, cover or internal components may result, causing failure or malfunction.

- Avoid repeatedly bending, stretching or applying a heavy object or force to the lead wire.

- Repetitive bending stress or tensile stress can cause the sheath of the wire to peel off, or breakage of the wire.

- If the lead wire can move, fix it near the body of the product.

- The recommended bend radius of the lead wire is 6 times the outside diameter of the sheath, or 33 times the outside diameter of the insulation material, whichever is larger.

- Replace the damaged lead wire with a new one.

- Wire correctly.

- Incorrect wiring can cause malfunction or damage the product.

- Do not perform wiring while the power is on.

- Otherwise damage to the internal components may result, causing malfunction.

- Do not route wires and cables together with power or high voltage cables.

- Route the wires of the product separately from power or high voltage cables to prevent noise and surge from entering the product.

- Confirm proper insulation of wiring.

- Poor insulation (interference with other circuits, poor insulation between terminals etc.) can apply excessive voltage or current to the product causing damage.

- Design the system to prevent reverse current when the product is performing an operational check.

- Depending on the circuit used, insulation may not be maintained when operation is forced, allowing reverse current to flow, which can cause malfunction and damage to the product.

- Keep wiring as short as possible to prevent interference from electromagnetic noise and surge voltage.

- Do not use a cable longer than 10 m.

- Wire the DC (-) line (blue) as close as possible to the power supply.

- When analogue output is used, install a noise filter (line noise filter, ferrite element, etc.) between the switch-mode power supply and the product.

• Operating environment

- Do not use the product in an environment where the product is constantly exposed to water splashes.
Otherwise failure or malfunction can result. Take measures such as using a cover.

- Do not use in an environment where the product could be exposed to corrosive gas or liquids.
Otherwise damage to the internal parts can result, causing malfunction.

Do not use the product in a place where the product could be splashed by oil or chemicals.

If the product is to be used in an environment containing oils or chemicals such as coolant or cleaning solvent, even for a short time, it may be adversely affected (damage, malfunction, or hardening of the lead wires).

- Do not use in an area where surges are generated.

When there are machines or equipment that generate large surges near the product (magnetic type lifter, high frequency inductive furnace, motor, etc.), this can result in deterioration and damage of the internal elements. Take measures against the surge sources, and prevent the lines from coming into close contact.

Do not use a load which generates surge voltage.

When a surge-generating load such as a relay or solenoid is directly driven, use the product with a surge absorbing element built-in.

- The product is CE marked, but not immune to lightning strikes. Take measures against lightning strikes in the system.

- Mount the product in a location that is not affected by vibration or impact.

Failure, malfunction or inaccurate measurements from the pressure switch may occur.

- Do not use the product in the presence of a magnetic field.

Malfunction can result.

- Do not let foreign matter, such as wire debris, get inside the product.

- In order to avoid failure and malfunction, do not let foreign matter, such as wire debris, get inside the product.

Do not use the product in an environment that is exposed to temperature cycle.

Heat cycles other than ordinary changes in temperature can adversely affect the internal components of the product.

- Do not expose the product to direct sunlight.

If using in a location directly exposed to sunlight, protect the product from the sunlight.

Failure or malfunction may occur.

- Keep within the specified ambient temperature range.

The ambient temperature range is 0 to 50°C.

Avoid abrupt temperature changes even within the specified temperature range. Failure, malfunction or inaccurate measurements from the pressure switch may occur.

- Do not operate close to a heat source, or in a location exposed to radiant heat.

Insufficient air quality may cause operation failure.

* Adjustment and Operation

- Connect a load before turning the power supply on.

If the power supply is turned on with no load, over current may flow, causing the product to break instantly.

- Do not short-circuit the load.

Although error is displayed when the product load has a short circuit, generated over current may lead to the damage of the product.

- Do not press the setting buttons with a sharp pointed object.

This may damage the setting buttons.

- Supply power under no flow conditions.

The measurement output of the flow switch is turned off for 3 seconds after the power is supplied.

- Perform settings suitable for the operating conditions.

Incorrect setting can cause operation failure.

For details of each setting, refer to page 20 to 59 of this Operation Manual.

- During the initial setting and flow rate setting, the product will switch the measurement output with the condition before setting.

Confirm the output has no adverse effect on machinery and equipment before setting.

Stop the control system before setting if necessary.

- Do not touch the LCD during operation.

The display can vary due to static electricity.

* Maintenance

- Confirm safety by turning off the power supply and stopping the flow before performing maintenance.

There is a risk of unexpected malfunction.

- Perform regular maintenance and inspections.

There is a risk of unexpected failure of components due to the malfunction of equipment and machinery.

- Do not use solvents such as benzene, thinner etc to clean the switch.

This may damage the surface of the body or erase the markings on the body.

Use a soft cloth to remove stains. For heavy stains, use a cloth soaked with diluted neutral detergent and fully squeezed, then wipe up the stains again with a dry cloth.

Model Indication Method

LFE 0 □ □ - □ □ □

Separate monitor

Output

Symbol	OUT1	OUT2
A	NPN	NPN
B	PNP	PNP
C	NPN	Analogue 1 to 5V
D	NPN	Analogue 4 to 20mA

Lead wire

Symbol	Content
Nil	Power and output lead wire (2m)
N	None

Connector

Symbol	Content
Nil	Non
C	Sensor connector (1 pcs.)

Panel type

Symbol	Content
Nil	None
T	Panel mount adapter
V	Front protective cover Panel mount adapter

Unit

Symbol	Instantaneous flow	Accumulated flow	Temp.
M	L/min	L	°C
G	gal/min	gal	°C

*G is made to order

Reference: 1 [L/min] ↔ 0.2642 [gal/min]

Reference: 1 [gal/min] ↔ 3.785 [L/min]

*: For the remote sensor, select analogue output: 1 to 5 V type . Applicable sensor: LFE□J□□

Connector

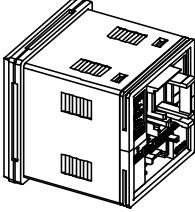
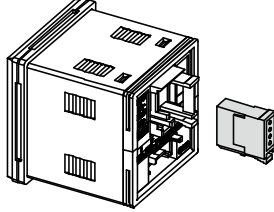
Nil	C
<p data-bbox="316 300 373 327">None</p> 	<p data-bbox="584 300 863 327">Sensor connector (1 pcs.)</p> 

Panel type

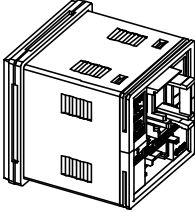
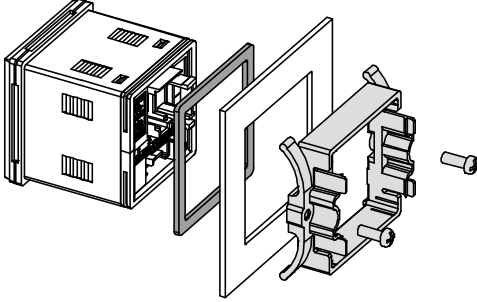
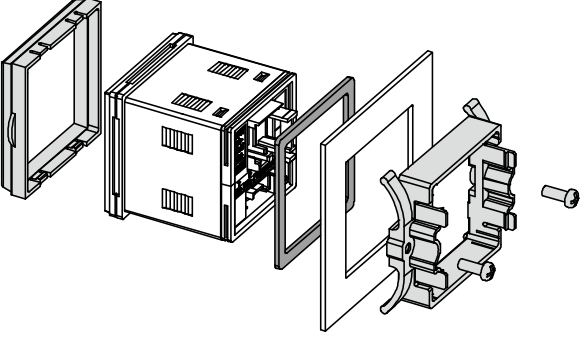
Nil	T
<p data-bbox="316 779 373 806">None</p> 	<p data-bbox="799 779 1027 806">Panel mount adapter</p> 
<p data-bbox="715 1182 737 1209">V</p>	
<p data-bbox="480 1240 970 1267">Front protective cover + Panel mount adapter</p> 	

Accessories/ Part numbers

If an accessory is required, order using the following part number.

Accessories	Part No.	Note
Panel mount adapter	ZS-26-B	Waterproof seal with screw
Front protective cover Panel mount adapter	ZS-26-C	Waterproof seal with screw
Protective cover only	ZS-26-01	Please order panel mount adapters etc. separately
Power supply/output lead wire	ZS-40-W	Lead wire length: 2 m
Sensor connector (e-con)	ZS-28-C-5	1 pc
Copy lead wire	ZS-40-Y	Possible to connect up to 10 slaves

Summary of product parts

Front

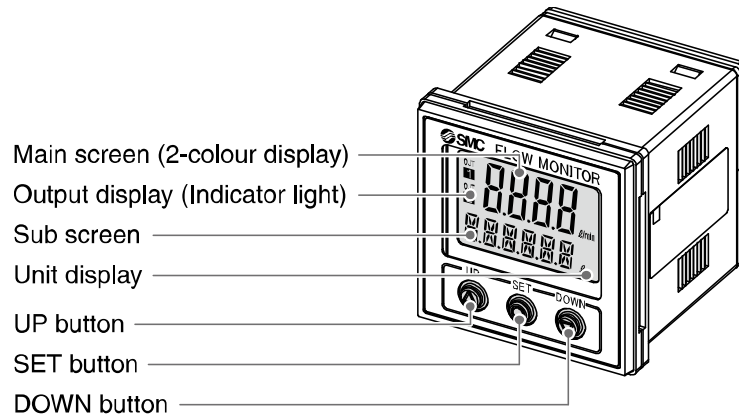

Title	Function
Main screen (2 colour display)	Displays the flow value, setting mode and error codes.
Sub screen	Displays the accumulated flow, set value, peak/bottom value, fluid temperature and line names. In the measurement mode, the set status is displayed.
Output display (Indicator light)	Displays the output status of OUT1 and OUT2. When ON: Orange LED is ON.
Units display	Indicates the unit currently selected.
UP button	Selects the mode and the display shown on the Sub display, or increases the ON/OFF set value.
SET button	Press this button to change the mode and to set a value.
DOWN button	Selects the mode and the display shown on the Sub display, or decreases the ON/OFF set value.

Back

Sensor connector

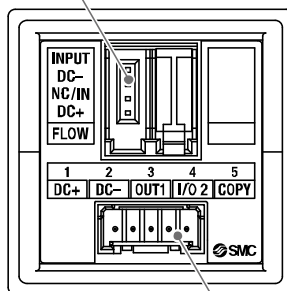

Power supply/output connector

■ Definition and terminology

	Term	Meaning
A	Accumulated flow	The total amount of fluid that has passed through the device. If an instantaneous flow of 10 L/min lasts for 5 minutes, the accumulated flow will be $10 \times 5=50$ L.
	Accumulated pulse output	A type of output where a pulse is generated every time a predefined accumulated flow passes. It is possible to calculate the total accumulated flow by counting the pulses.
	Accumulated value hold	A function to store the cumulative flow value in the product's internal memory at a certain time intervals. When the power supply is turned on, the memorized flow value will be read out, and accumulation will be started with that value. The time interval for memorizing can be selected from 2 or 5 minutes.
	Ambient temperature range	Ambient temperature range in which the product can operate.
	Analogue output	Outputs a value proportional to the flow rate. When the analogue output is in the range 1 to 5V, it will vary between 1 to 5V according to the rate of flow. The same for analogue output of 4 to 20mA.
C	Chattering	The problem of the switch output turning ON and OFF repeatedly around the set value at high frequency due to the effect of pulsation.
	Copy function	A function to copy flow rate setting values and function settings (excluding fine adjustment of indication value).
D	Display flow range	The range of measured values that can be displayed for a product with a digital display.
F	F.S.(full span/full scale)	This means "full span" or "full scale", and indicates varied analogue output range at rated value. For example, when analogue output is 1 to 5V, $F.S.=5[V] - 1[V]=4[V]$. (Reference: $1\%F.S. = 4[V] \times 1\% = 0.04[V]$)
H	Hysteresis	The difference between ON and OFF points used to prevent chattering. Hysteresis can be effective in avoiding the effects of pulsation.
	Hysteresis mode	Mode where the switch output will turn ON when the flow is greater than the set value, and will turn OFF when the flow falls below the set value by the amount of hysteresis or more.
I	Instantaneous flow	The flow passing per unit of time. If it is 10 L/min, there is a flow of 10 L passing through the device in 1 minute.
	Internal voltage drop	The voltage drop across the product (and therefore not applied to the load), when the switch output is ON. The voltage drop will vary with load current, and ideally should be 0 V.
K	Key-lock function	Function that prevents changes to the settings of the product (disables button operation).
M	Min. setting unit	The resolution of set and display values. If the minimum setting unit is 1 L/min, the display will change in 1 L/min steps, e.g. 10.....11.....12 L/min.
O	Operating fluid temperature	Fluid temperature range which can be applied to the product.

	Term	Meaning
P	Power saving mode	Number display is turned off to reduce power consumption.
R	Repeatability	Reproducibility of the display or analogue output value, when the measured quantity is repeatedly increased and decreased.
	Response time	Time from when the target flow is applied until the flow reaches 63% of the set value.
S	Set flow range	The range of ON/OFF threshold values that can be set for those products with a switch output.
	Switch output	Output type that has only 2 conditions, ON or OFF. In the ON condition an indicator LED will show, and any connected load will be powered. In the OFF condition, there will be no indicator LED and no power supplied to the load. An output showing such behavior is called switch output.
T	Temperature characteristics	Indicates the change in the display value and analogue output caused by ambient temperature changes.
U	Unit selection function	A function to select display units other than the international unit (SI unit) specified in the new Japanese measurement law.
W	Water hammer	A momentary steep pressure increase due the spread of pressure by closing a contactor such as a valve for an extremely short time while there is a flow. This pressure increase is known as water hammer or impact pressure.
	Window comparator mode	An operating mode in which the switch output is turned on and off depending on whether the flow is inside or outside the range of two set values

Mounting and Installation

■ Installation

Mounting by panel mount adapter

Fix the panel mount adapter to the controller by the mounting screws M3 x 8L (2 pcs.).

Panel mount adapter (Part number: ZS-26-B)

Front protective cover (Part number: ZS-26-01)

Water proof seal
(Accessory)

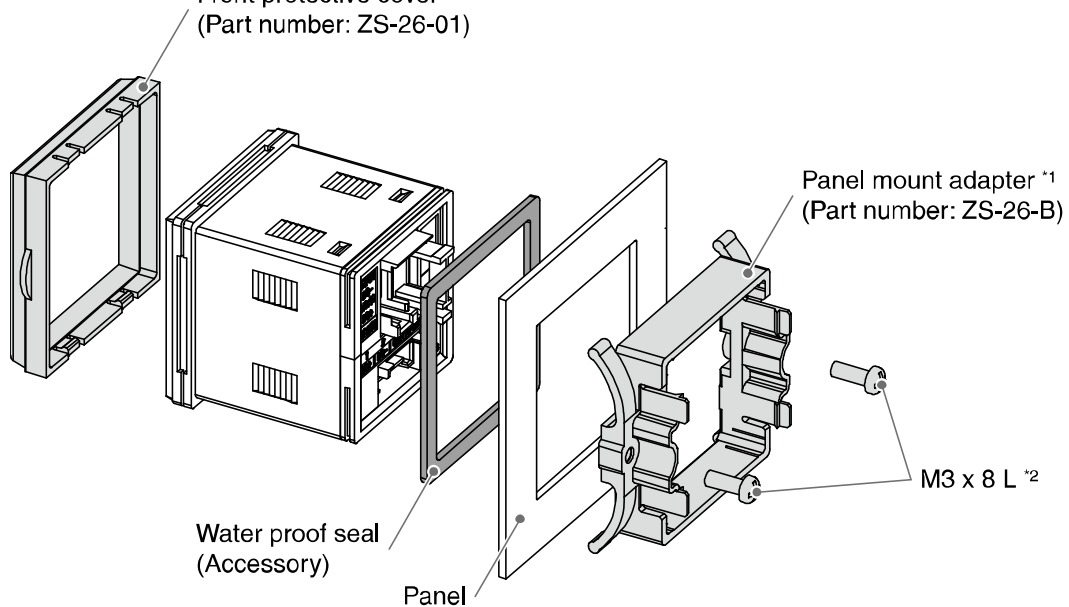

*1: The panel mount adapter can be rotated through 90 degrees for mounting.

*2: The panel mount adapter should be fixed firmly with screws. Otherwise, fluids such as water may enter. After the product makes contact with the panel, the screws should be further tightened 1/4 to 1/2 turn.

Cut-out dimensions for panel mounting

*: See page 68 for panel cut-out dimensions.

How to remove the panel mount adapter

The product with panel mount adapter can be removed from the panel after removing the two screws, and by disconnecting the hooks on both sides.

This can be done by inserting a suitable piece of thin card (as shown in the figure).

Pull the panel mount adapter to the front, and remove the flow monitor.

If the panel mount adapter is pulled forward with the hook caught, the product and the adapter may be damaged.

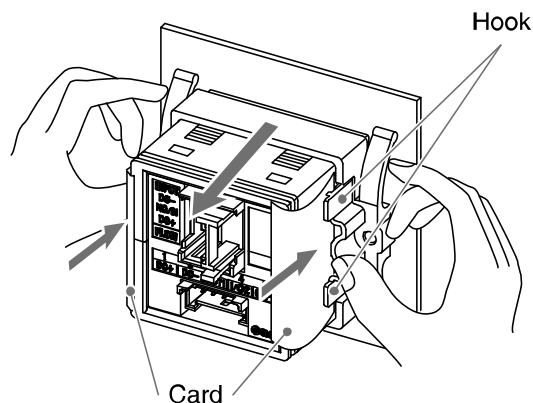

■ Wiring

Connecting and disconnecting of the sensor connector and power supply/output connector

When connecting, insert the connectors straight into the body until it clicks.

- When removing the connector, press down the lever to release the hook from the housing and pull the connector straight out.

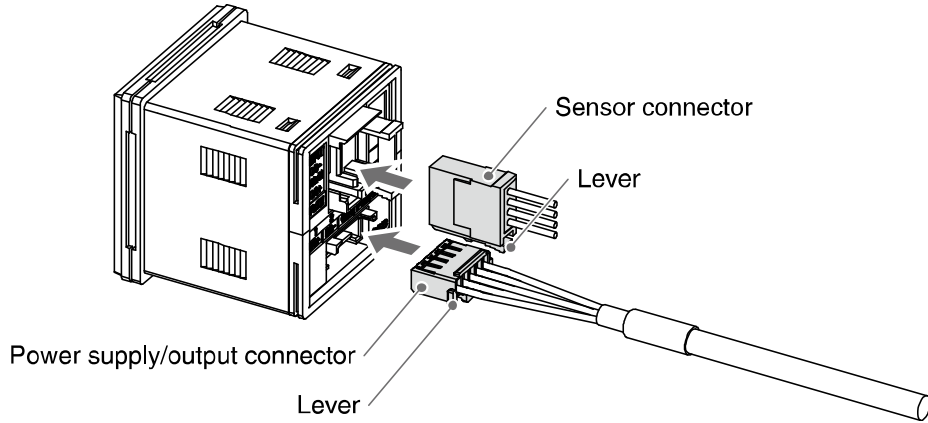

Sensor connector

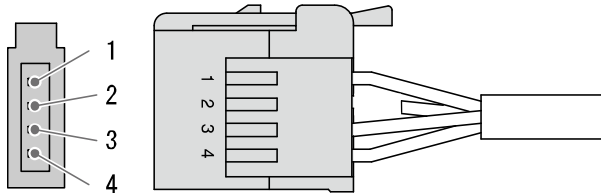

1	DC (+): Brown
2	N.C./ IN: Unused Do not connect to Black.
3	DC (-): Blue
4	INPUT : White (flow sensor 1 to 5 V)

Power supply / output connector

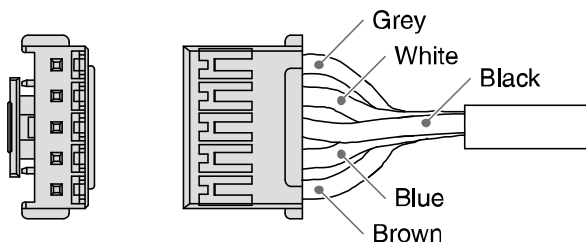

COPY: Grey
OUT2: White
OUT1: Black
DC (-): Blue
DC (+): Brown

Wiring of connector

Attaching/detaching of the connector should be done while the power supply is turned off.

Use a separate route for the product wiring and any power or high voltage wiring.

Otherwise, malfunction may result due to noise.

Ensure that the FG terminal is connected to ground when using a commercially available switch-mode power supply.

If the switch-mode power supply is connected for use, switching noise will be superimposed and it will not be able to meet the product specifications. This can be prevented by inserting a noise filter such as a line noise filter and a ferrite element between the switch-mode power supply and the pressure switch, or by using a series power supply instead of a switch-mode power supply.

Connection of the sensor lead wire and connector

•Strip the sensor lead wire as shown in the figure on the right.

(Refer to the following table for the connector and applicable wire size.)

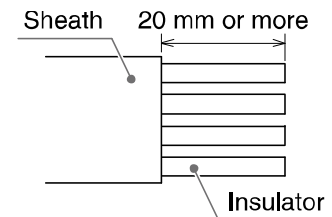

Applicable wire

SMC product No. (1 pc.)	Colour of cover	Insulator outside diameter
ZS-28-C-5 (Included in the product)	Grey	ø 1.6~ø 2.0

- Do not cut the insulator.
- The core of the corresponding colour shown in the table below is put into the pin of the number stamped on the connector for sensor connection to the back.

Number stamped on connector	Lead wire core colour *
1	Brown
2	Empty
3	Blue
4	White

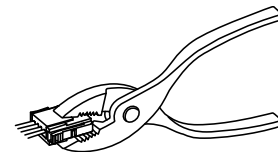
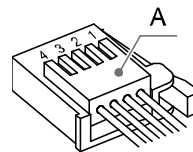

*: When using the lead wire with M12 connector included with the LFE series.

- It checks that the above-mentioned preparation work has been performed correctly, and "A" part shown in the left figure is pushed by hand and makes temporary connection.
- "A" part's center is straightly pushed in by tools, such as pliers.
- The connector for sensor cannot be reused once crimped.
- For the connection failure such as incorrect order of wire and incomplete insertion, please use the new connector for sensor connection.
- When the sensor is not connected correctly, "LLL" can be displayed.

Internal Circuit and Wiring examples

NPN 2 output type
LFE0A

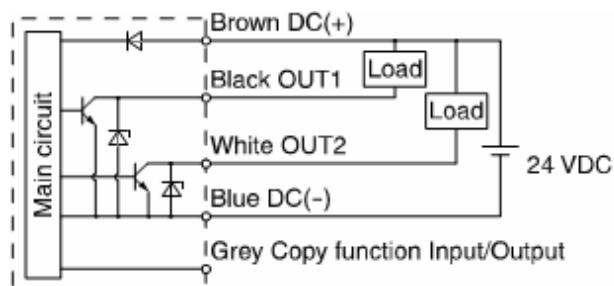

Max.28 V, 80 mA
Internal voltage drop 1 V max.

PNP 2 output type
LFE0B

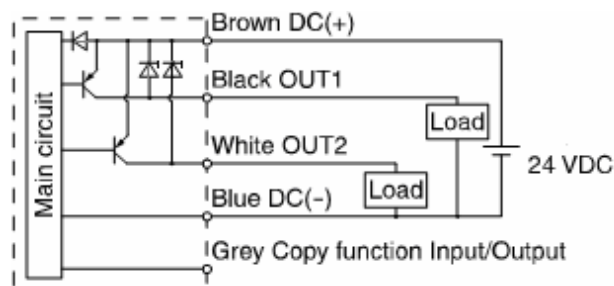

Max.80 mA
Internal voltage drop 1.5 V max.

NPN + Analogue output type
LFE0C

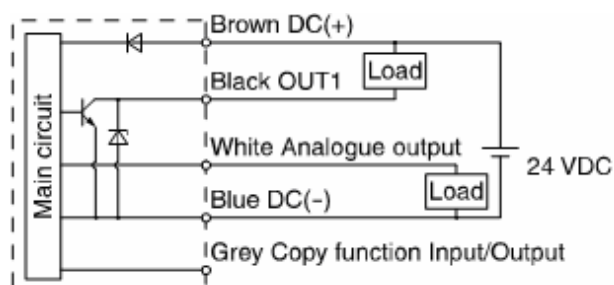

Max.28 V, 80 mA
Internal voltage drop 1 V max.
Analogue output 1 to 5 V
Output impedance 1 kΩ

NPN + Analogue output type
LFE0D

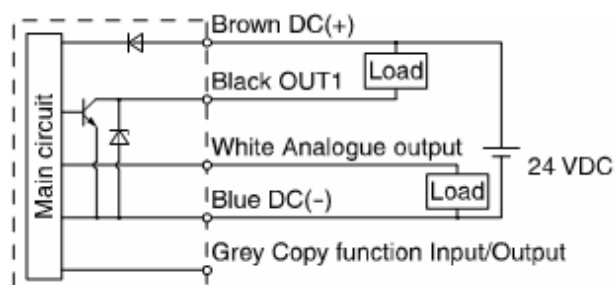

Max.28 V, 80 mA
Internal voltage drop 1 V max.
Analogue output 4 to 20mA
Max. load impedance 600 Ω

Example of wiring for accumulated pulse output

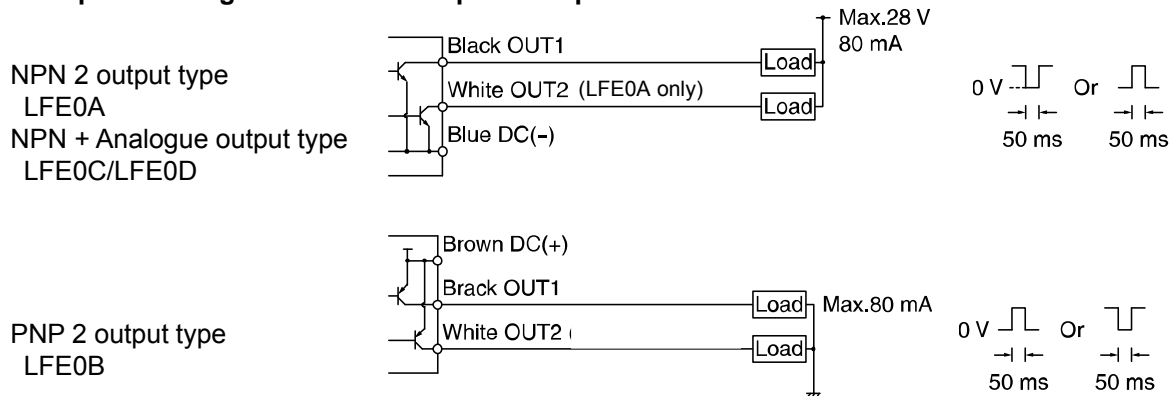

When accumulated pulse output is selected, the indicator light is turned off.

Flow Setting

Measurement mode

Measurement mode is the condition where the flow is detected and displayed, and the switch function is operating.

This is the basic mode; other modes should be selected for set-point changes and other function settings.

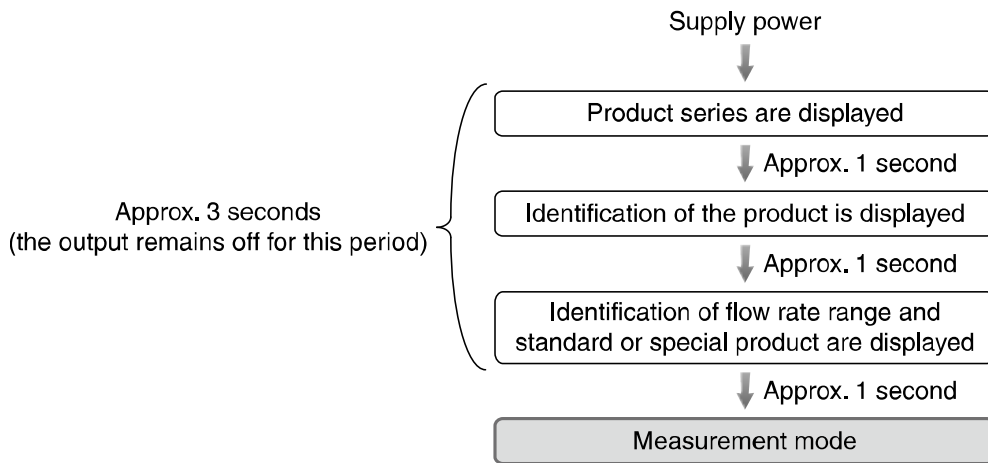

Be sure to select the correct sensor to be connected. (Page 24)

Set ON and OFF points of the switch output.

Switch operation

When the flow exceeds the set value, the switch will be turned on.

When the flow falls below the set value by the amount of hysteresis or more, the switch will be turned off.

If the operation shown below is acceptable, then keep these settings.

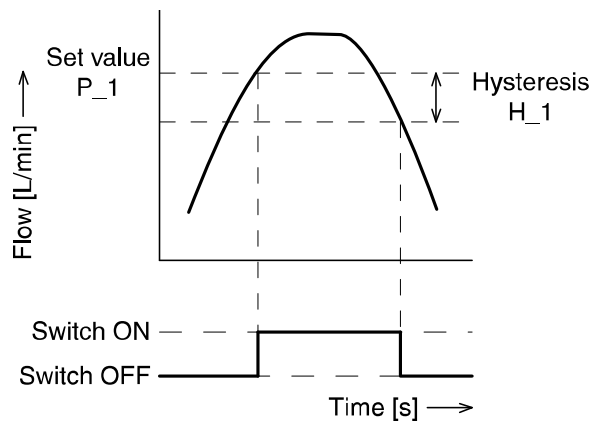

<Operation>

1. Press the  button in measurement mode.

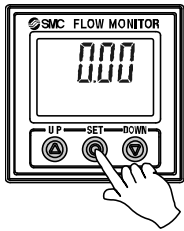

2. [P_1] or [n_1] and the set value are displayed alternately.

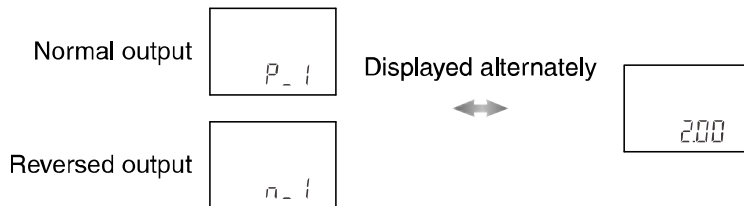

3. Press the  or  button to change the set value.
The button  is to increase and the  button is to decrease the set value.

• Press the  button once to increase by one digit, or press and hold to continuously increase.

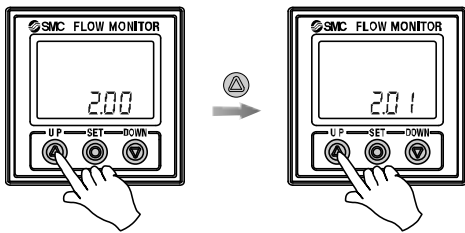

Press the  button once to decrease by one digit, or press and hold to continuously decrease.

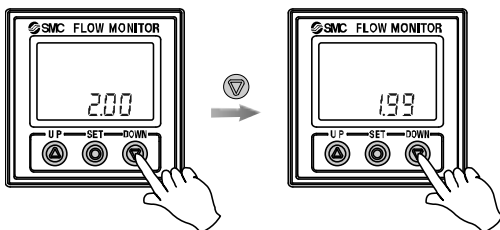

4. Press the  button to finish the setting.

The Flow switch turns on within a set flow range (from P1L to P1H) during window comparator mode. Set P1L (switch lower limit) and P1H (switch upper limit) using the setting procedure above.



When reversed output is selected, the main screen displays [n1L] and [n1H]

For models with 2 outputs [P_2] or [n_2] will be displayed. Set as above.

*: If a button operation is not performed for 30 seconds during the change of setting, the set value will start flashing.



Function setting

Function selection mode

In measurement mode, when the  button is pressed for 2 seconds or longer, [F 0] is displayed. This [F] indicates the mode for changing each functional setting. Press and hold the  button for 2 seconds or longer to return to measurement mode.

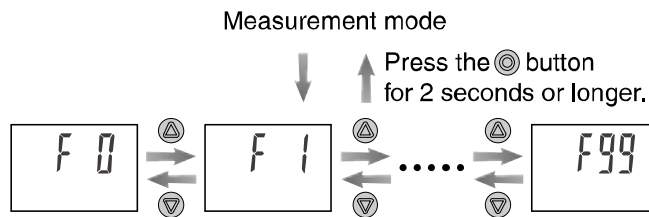
*: The sub screen displays the content of the function and the function setting in turn.



 The function is increased and decreased by the  button. Display the required function number and press the  button.

Default Setting

The default settings are as follows.

If these settings are acceptable, retain for use.

To change a setting, enter function selection mode (Refer to the table below).

• [F 0] Selection of sensor ➡ See page 24

Item	Description	Default setting
Range selection of the sensor to be connected	The flow rate range of the sensor to be connected is set.	Rated flow rate 20 L/min type

• [F 1] Setting of OUT1 ➡ See page 25

Item	Description	Default setting
Output mode	Selects the switch output type from: Instantaneous flow (either hysteresis or window comparator mode), accumulated flow, accumulated pulse.	Hysteresis mode
Reversed output	Selects which type of switch output is to be used, normal or reversed.	Normal output
Set value	Sets the ON and OFF point of the switch output	50% of rated flow
Hysteresis	Setting of hysteresis can prevent chattering.	5% of rated flow
Display colour	Select the colour of the main display.	Output ON: Green Output OFF: Red

• [F 2] Setting of OUT2 ➡ See page 33

Item	Description	Default setting
Output mode	Selects the switch output type from: Instantaneous flow (either hysteresis or window comparator mode), accumulated flow, accumulated pulse or fluid temperature (either hysteresis mode or window comparator mode).	Hysteresis mode for instantaneous flow
Reversed output	Selects which type of switch output is to be used, normal or reversed.	Normal output
Set value	Sets the ON and OFF point of the switch output	50% of rated flow
Hysteresis	Setting of hysteresis can prevent chattering.	5% of rated flow



*: Display colour is linked to the setting of OUT1, and can not be selected.

• Other parameter setting

Item	Page	Default setting
[F3] Response time	39	1 sec.
[F10] Sub screen	40	Display of set value
[F20] Setting of external input	44	-
[F22] Analogue output	45	Free range analogue output for instantaneous flow: OFF*
[F30] Storing of accumulated flow	47	OFF
[F80] Power saving mode	48	OFF (display is turned on)
[F81] Setting of security code	49	OFF
[F82] Input of line names	50	No name
[F90] Setting of all functions	51	OFF
[F96] Input value check	52	Display of input voltage (sensor output voltage)
[F97] Selection of copy function	53	OFF
[F98] Output check	56	OFF
[F99] Reset to the default settings	57	OFF

*: There is no analogue output free range function for fluid temperature.

Display of sub screen

In measurement mode, the display of the sub screen can be temporarily changed by pressing the  or  buttons.

*: After 30 seconds, it will automatically reset to the display selected in [F10]. (Page 40)

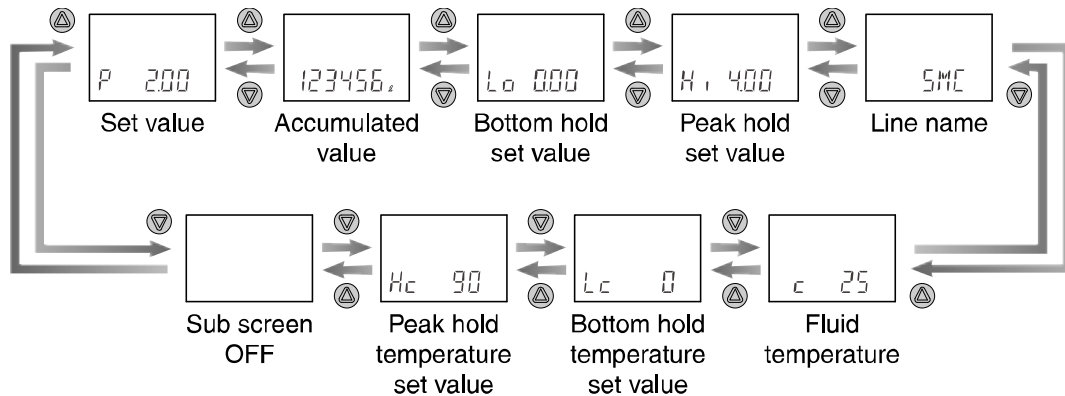

The set values of OUT2 and accumulated output cannot be displayed. (Example for 20 L/min type the above)

* Temperature peak, temperature bottom, and fluid temperature display are items which are not used for this product.

•[F 0] Selection of sensor

Select the connected sensor before use.

In measurement mode, when the  button is pressed for 2 seconds or longer, [F 0] is displayed.



➡ The sub screen displays [RANGE] and the currently selected flow rate alternately.

↓ Press the  button.

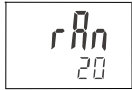

↓ Sub screen

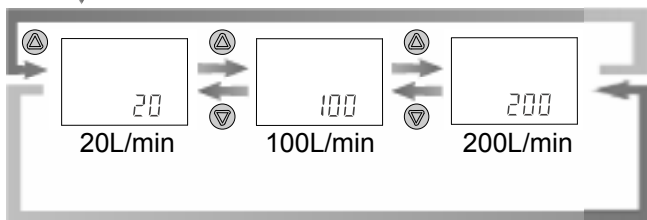

Press the  or  button to select the sensor to be connected.

Press the  button to confirm. ↓ Return to function selection mode.

[F 0] Sensor selection is completed.

- [F 1] Setting of OUT1
Set the output mode of OUT1.

<Function setting Flowchart>

1. Selection of output mode

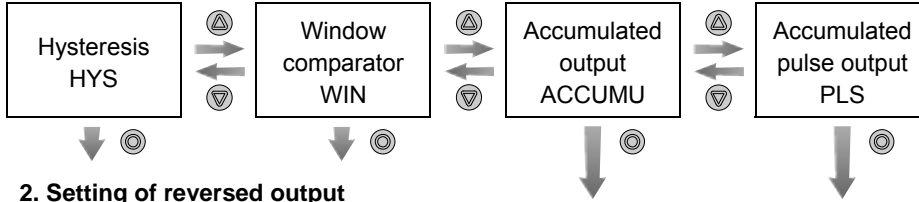

2. Setting of reversed output

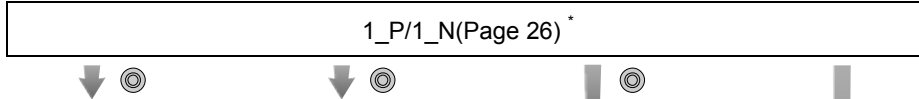

3. Input of set values

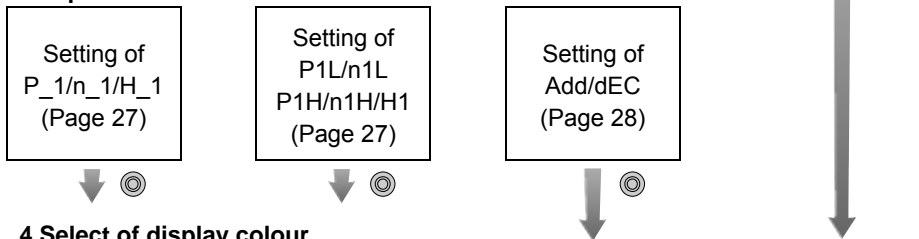

4 Select of display colour



5. Completed

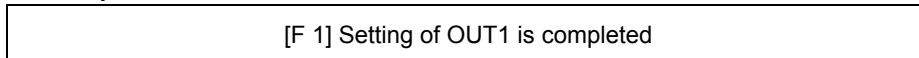

*: By switching to reversed output, the display colour will change in relation to the setting.

<Operation>

1. Selection of output mode

Press the or button in function selection mode to display [F 1] on the main screen.

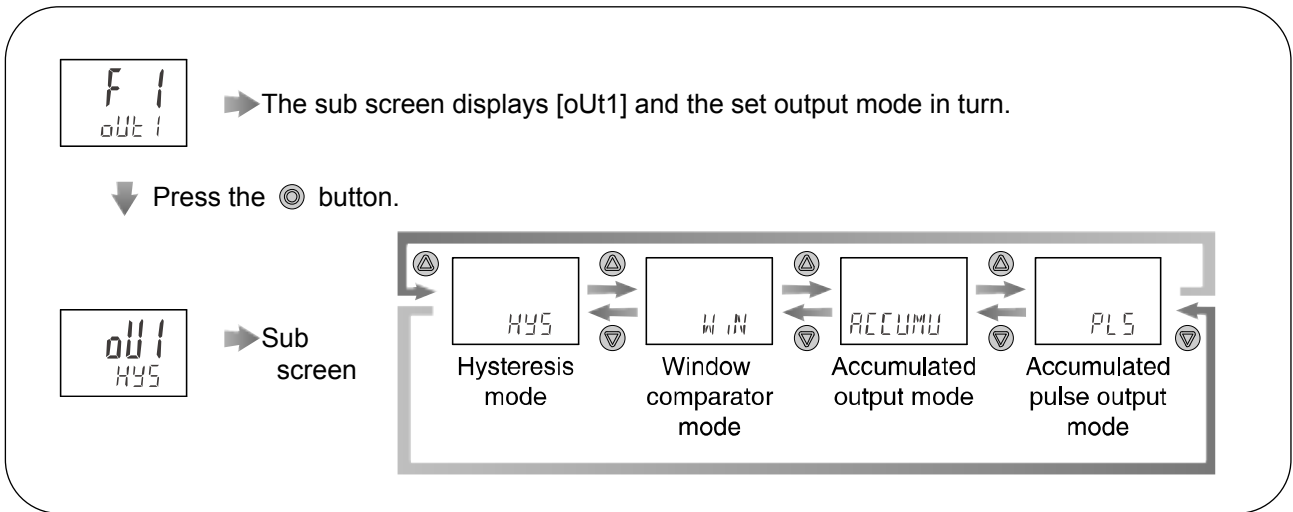

Press the or button to select the desired output mode.

Press the button to confirm. Move on to the setting of reversed output.

*: If a button operation is not performed for 30 seconds during the change of setting, the display will flash.

(This is to prevent the setting from remaining incomplete if, for instance, an operator were to leave during setting.)

*: When the accumulated pulse output is selected, the output display will turn off.

2. Setting of reversed output

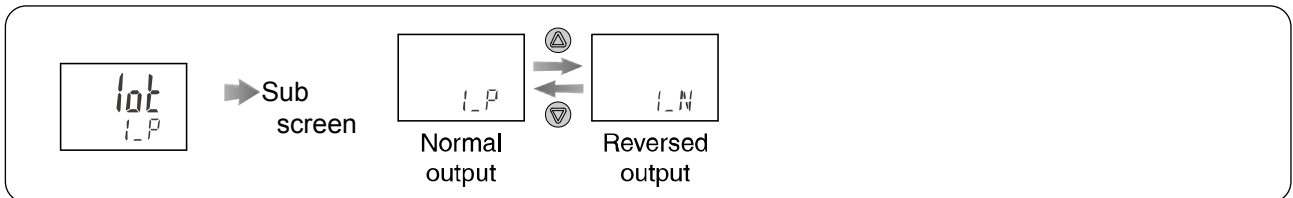

Press the or button to select the reversed output.

Press the button to confirm. Move on to the input of set values.
(ON and OFF points)

3. Input of set values

a. When hysteresis mode is selected



➡ The sub screen displays the set value. Change it with the ▲ or ▼ button.
(When reversed output is selected, the main screen displays [n_1].)

Press the ● button to confirm. ↓ Move on to the setting of hysteresis.

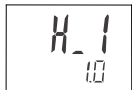

➡ The sub screen displays the hysteresis value. Change it with the ▲ or ▼ button.

Press the ● button to confirm. ↓ Move on to the selection of display colour (Page 30).

*: The set value and hysteresis settings limit each other.

b. When window comparator output mode is selected.

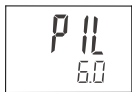

➡ The sub screen displays the set value. Change it with the ▲ or ▼ button.
(When reversed output is selected, the main screen displays [n1L].)

Press the ● button to confirm. ↓ Move on to the input of set value for [P1H] (or [n1H]).

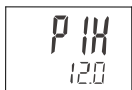

➡ The sub screen displays the set value. Change it with the ▲ or ▼ button.
(When reversed output is selected, the main screen displays [n1H].)

Press the ● button to confirm. ↓ Move on to the setting of hysteresis.



➡ The sub screen displays the hysteresis value. Change it with the ▲ or ▼ button.

Press the ● button to confirm. ↓ Move on to the selection of display colour (Page 30).

c. When Accumulated output is selected

Selection of accumulated increment (addition) or decrement (subtraction)

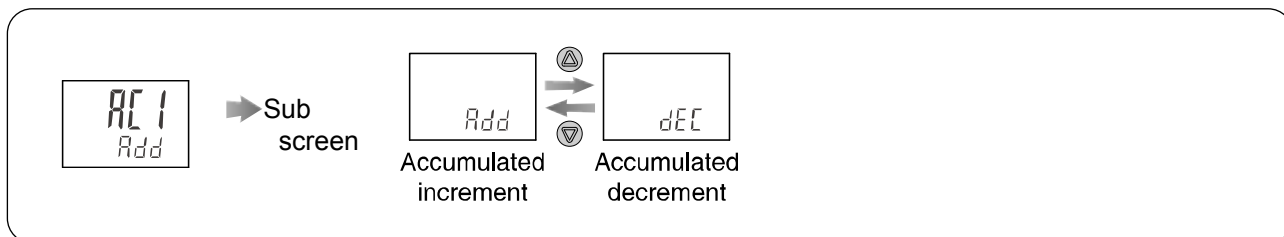

Press the ▲ or ▼ button to select the desired output mode.

Press the ◎ button to confirm. ↓ Move on to the input of set values.

Accumulated increment more

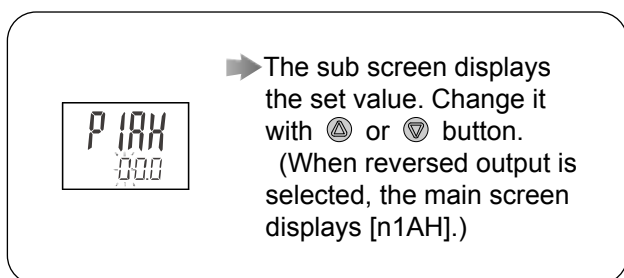

Accumulated decrement mode

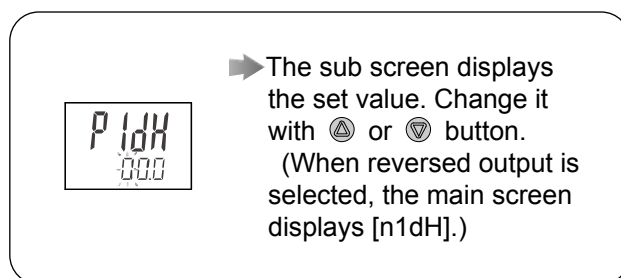

↓ (Continued)

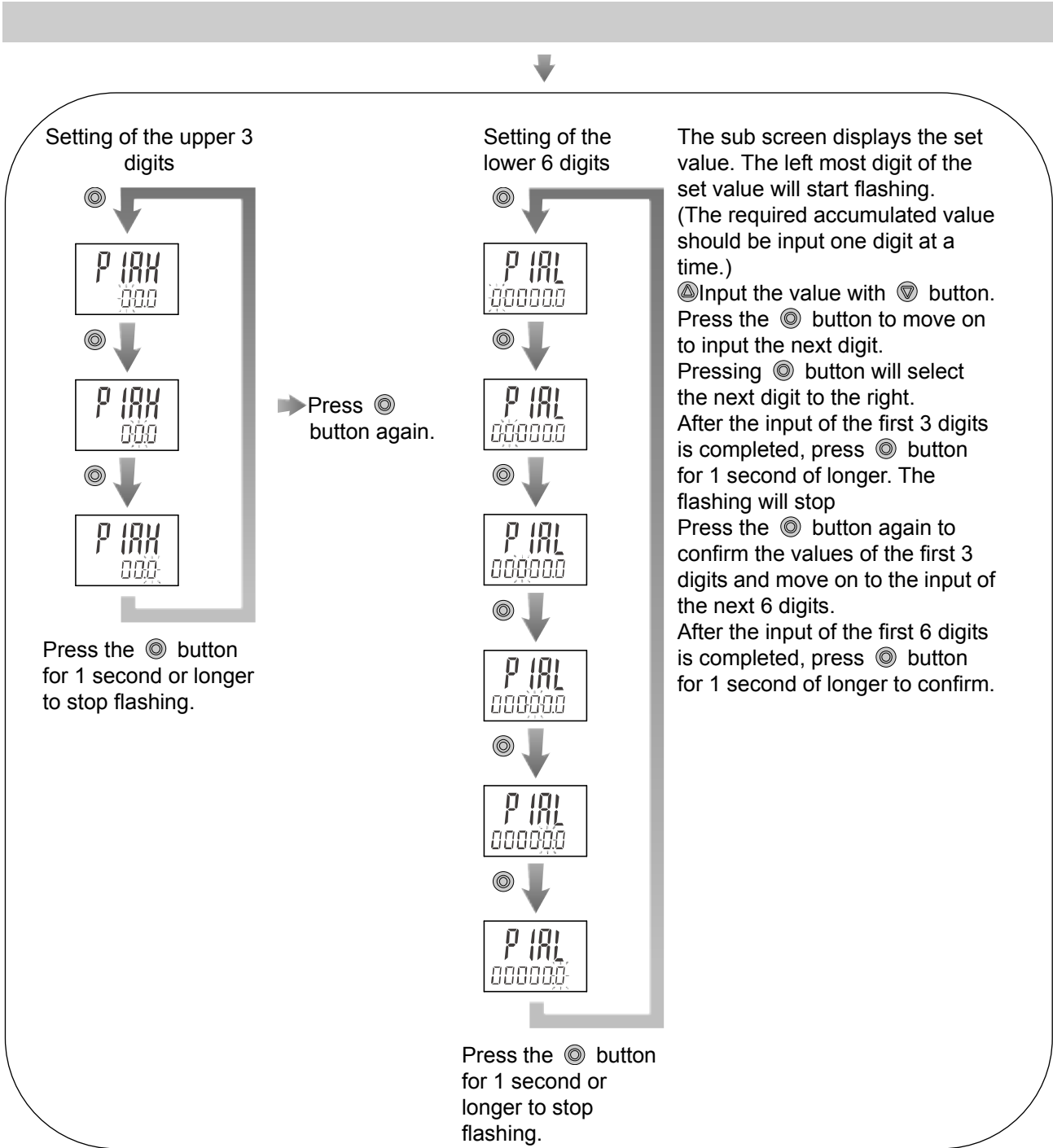

Press the [confirm] button to confirm. ↓ Move on to the selection of display colour.

4. Selection of display colour

The display colour can be set to change depending upon the status of OUT1.

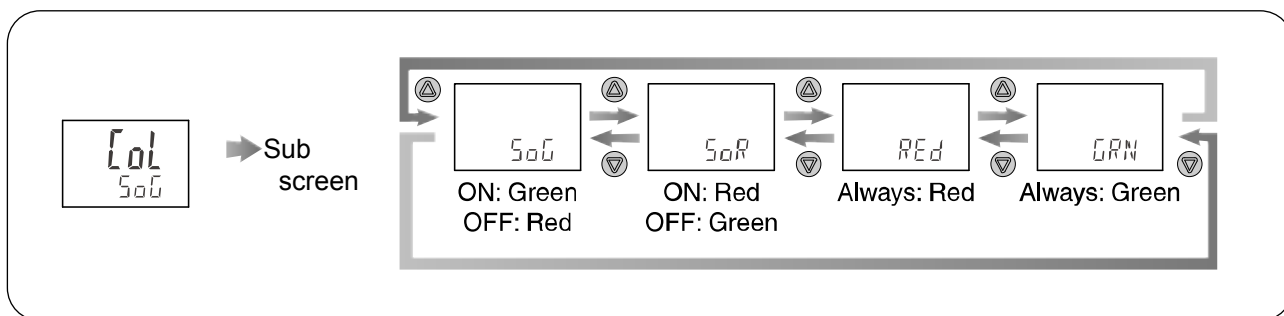

Press the ▲ or ▼ button to select the display colour.

Press the ● button to confirm. ↓ Return to function selection mode.

5. Completed

[F 1] Setting of OUT1 is completed

• List of output mode

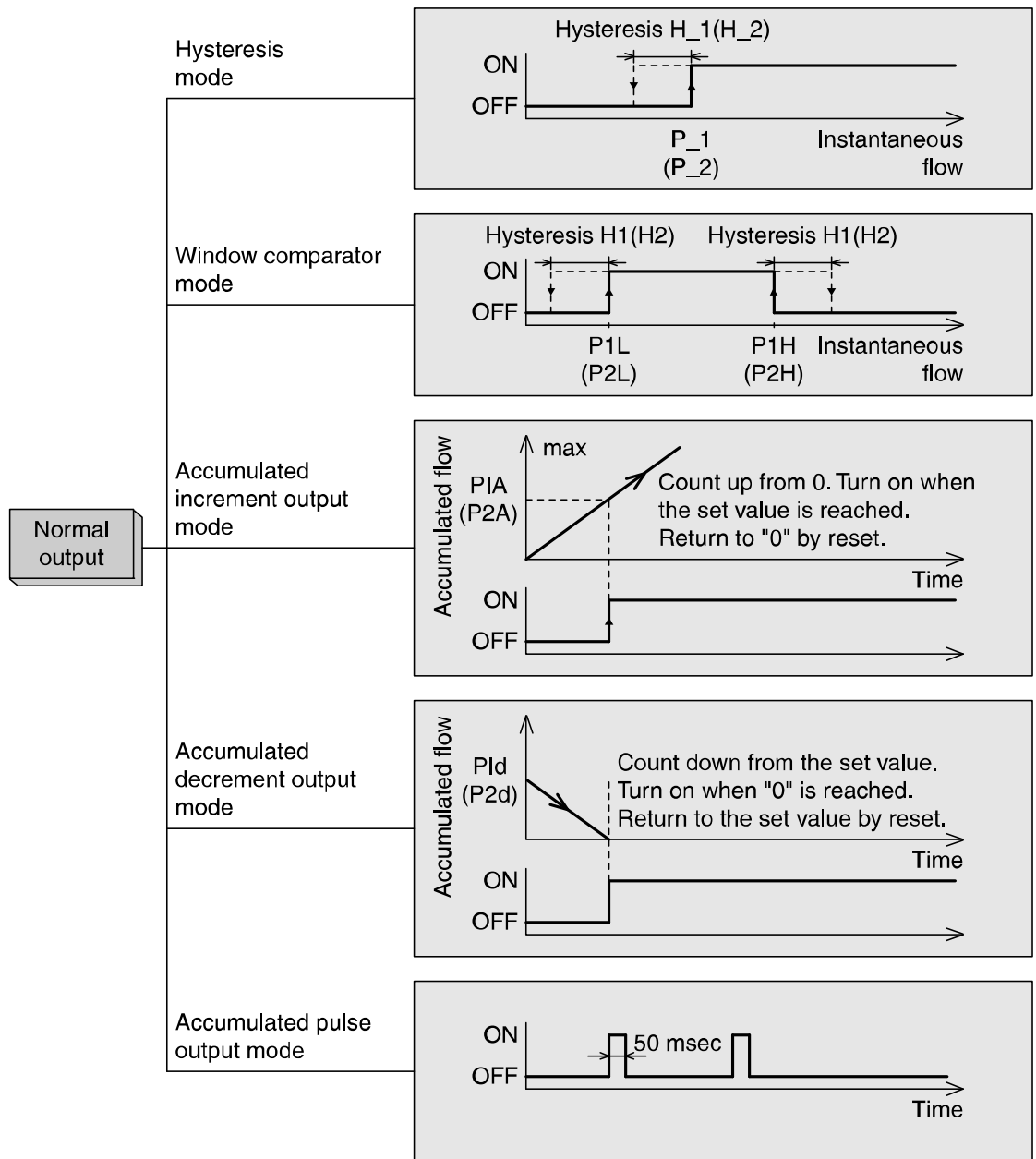

*: If hysteresis or window comparator mode are selected during unstable flow conditions (due to fluid pulsation, for example), unstable output operation can result.

In such situations, keep sufficient margin between the set values and confirm that the output operation stabilizes.

*: When the accumulated pulse output is selected, the output display will turn off.

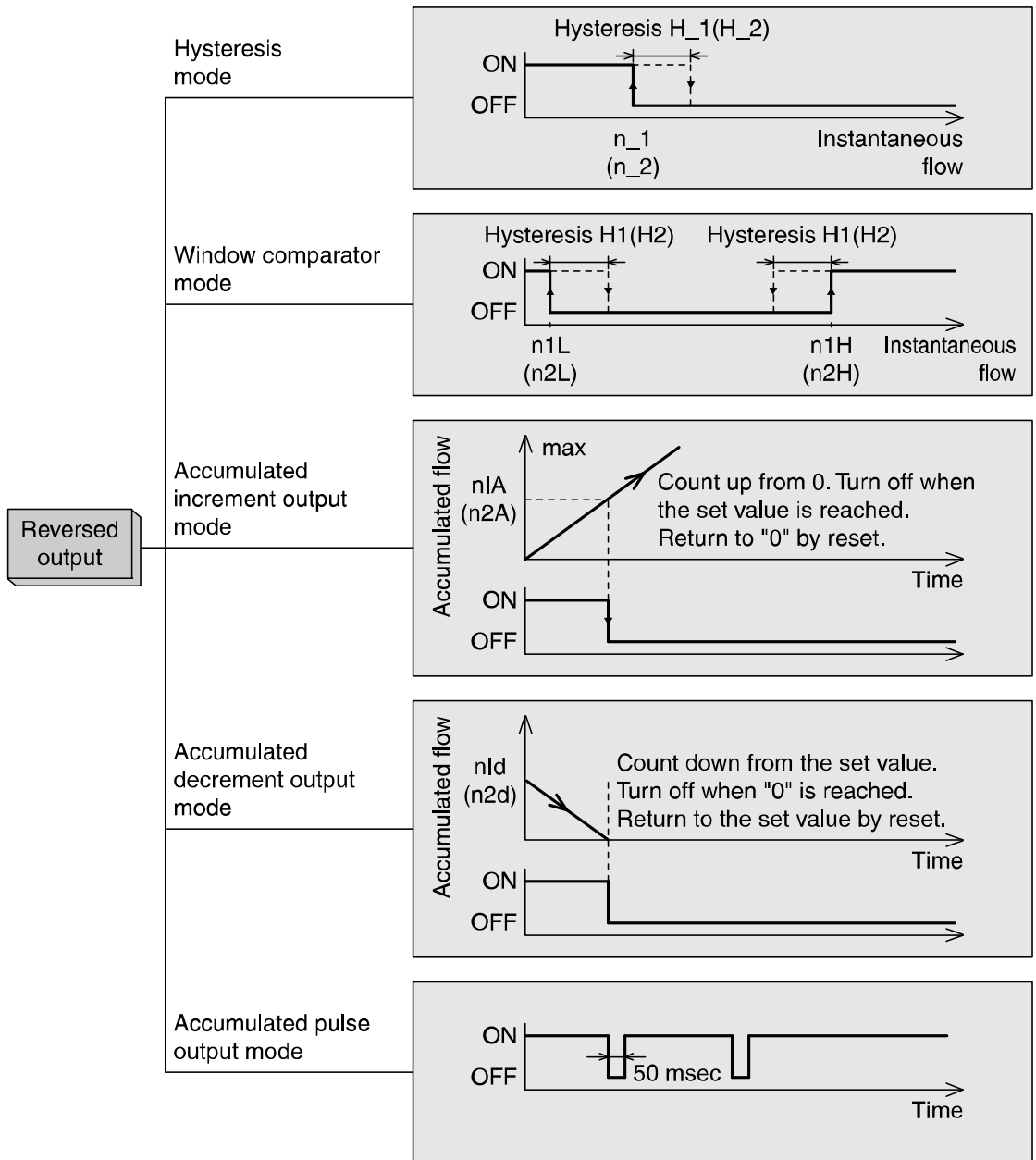

■ [F 2] Setting of OUT2

Set the output mode of OUT2.

The display colour is defined by OUT1 and cannot be changed with any OUT2 settings

<Function setting Flowchart>

1. Selection of output mode

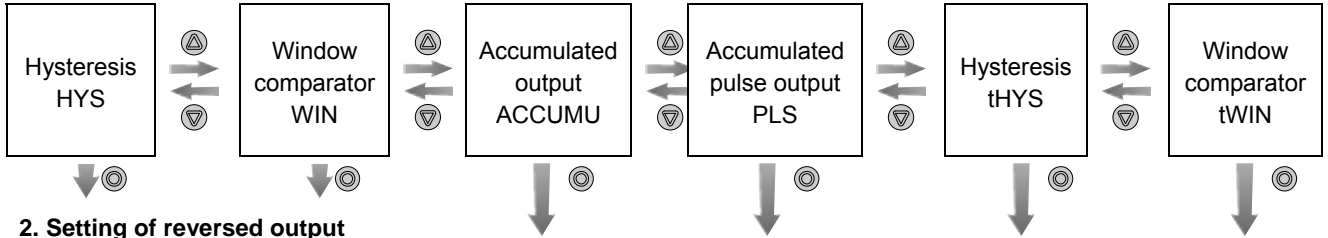

2. Setting of reversed output

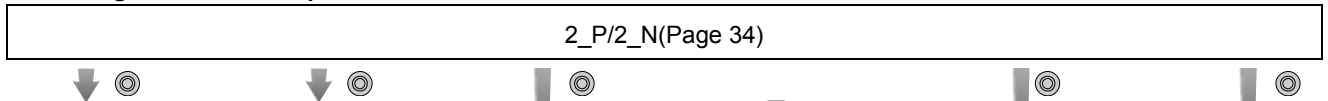

3. Input of set values

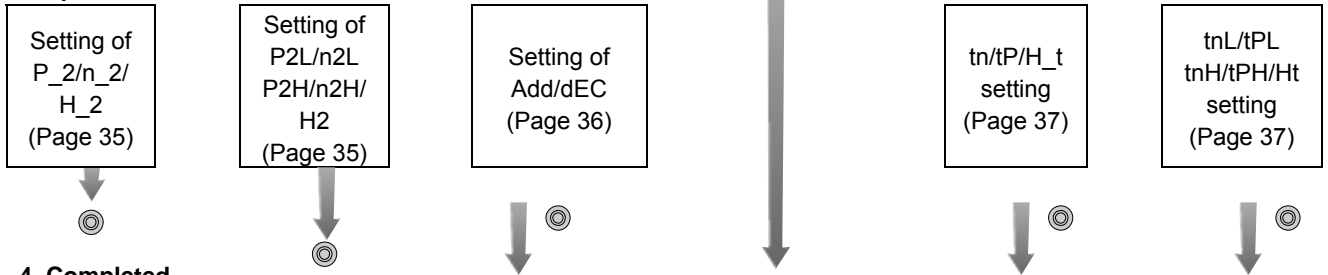

4. Completed

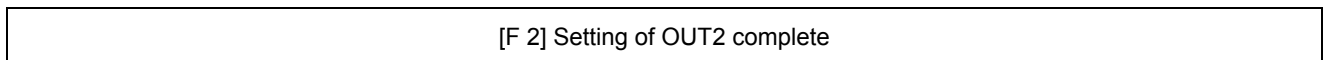

<Operation>

1. Selection of output mode

Press the or button in function selection mode to display [F 2] on the main screen.

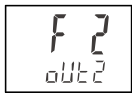

➔ The sub screen displays [oUt2] and the currently set output mode alternately.
: If OUT2 is not provided, the display will be [---].

↓ Press the button.



↓ Sub screen

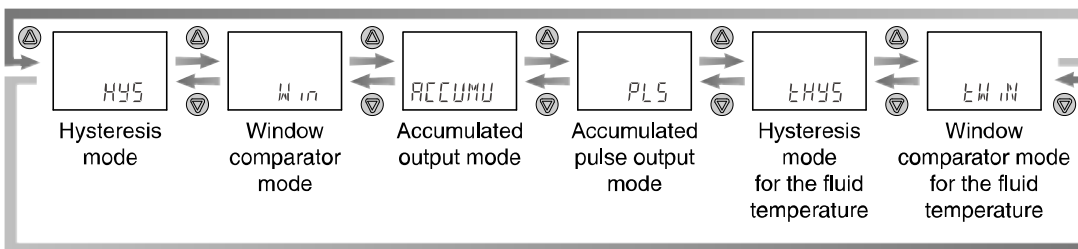

Press the or button to select the desired output mode.

Press the button to confirm. ↓ Move on to the setting of reversed output.

* Hysteresis/ comparator mode for fluid temperature are items which are not used for this product.

2. Setting of reversed output



➔ Sub screen

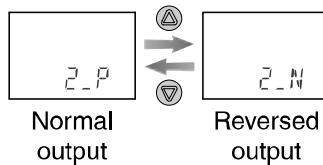

Press the or button to select reversed output mode.

Press the button to confirm. ↓ Move on to the input of set values.
(ON and OFF points)

3. Input of set values

a. When hysteresis mode is selected



➡ The sub screen displays the set value. Change it with the or button.
(When reversed output is selected, the main screen displays [n_2].)

Press the button to confirm. Move on to the setting of hysteresis.



➡ The sub screen displays the hysteresis value. Change it with the or button.

Press the button to confirm. Return to function selection mode.

4. Completed

[F 2] Setting of OUT2 is completed

*: The set value and hysteresis settings limit each other.

b. When window comparator output mode is selected.



➡ The sub screen displays the set value. Change it with the or button.
(When reversed output is selected, the main screen displays [n2L].)

Press the button to confirm. Move on to the input of set value for [P2H] (or [n2H])

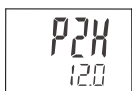

➡ The sub screen displays the set value. Change it with the or button.
(When reversed output is selected, the main screen displays [n2H].)

Press the button to confirm Move on to the setting of hysteresis.



➡ The sub screen displays the hysteresis value. Change it with the or button.

Press the button to confirm. Return to function selection mode.

4. Completed

[F 2] Setting of OUT2 is completed

c. When Accumulated output is selected

Selection of accumulated increment (addition) or decrement (subtraction)

The setting of Add/dEC is linked to the setting of OUT1, and can not be selected. (Page 28)

Accumulated increment more



➔ The sub screen displays the set value. Change it with the ▲ or ▼ button. (When reversed output is selected, the main screen displays [n2AH].)

Accumulated decrement mode



➔ The sub screen displays the set value. Change it with the ▲ or ▼ button. (When reversed output is selected, the main screen displays [n2dH].)

For details, refer to c. When accumulated output mode is selected" on page 28.

Press the ● button to confirm. ↓ Return to the function selection mode.

4. Completed

[F 2] Setting of OUT2 is completed

d. When hysteresis mode for fluid temperature is selected

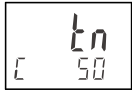

➔ The sub screen displays the set value. Change it with the or button.
(When normal output is selected, [P1dH] will be displayed.)

Press the button to confirm. Move on to the setting of hysteresis.

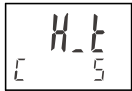

➔ The sub screen displays the set value. Change it with the or button.

Press the button to confirm. Return to function selection mode.

4. Completed

[F 2] Setting of OUT2 is completed

* Items which are not used for the this product.

e. When window comparator mode for fluid temperature is selected.

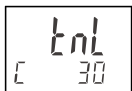

➔ The sub screen displays the set value. Change it with the or button.
(When normal output is selected, the main screen displays [tPL].)

Press the button to confirm. Move on to the input of set values for [tPH] (or [tNH]).

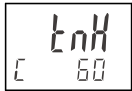

➔ The sub screen displays the set value. Change it with the or button.
(When normal output is selected, the main screen displays [tPH].)

Press the button to confirm. Move on to the setting of hysteresis.



➔ The sub screen displays the set value. Change it with the or button.

Press the button to confirm. Return to function selection mode.

4. Completed

[F 2] Setting of OUT2 is completed

*: The left most digit [c] shows Centigrade (°C). [F] shows Fahrenheit [°F] shows Fahrenheit. (Fahrenheit is available as made to order.)

* Items which are not used for the this product.

• List of output modes for fluid temperature

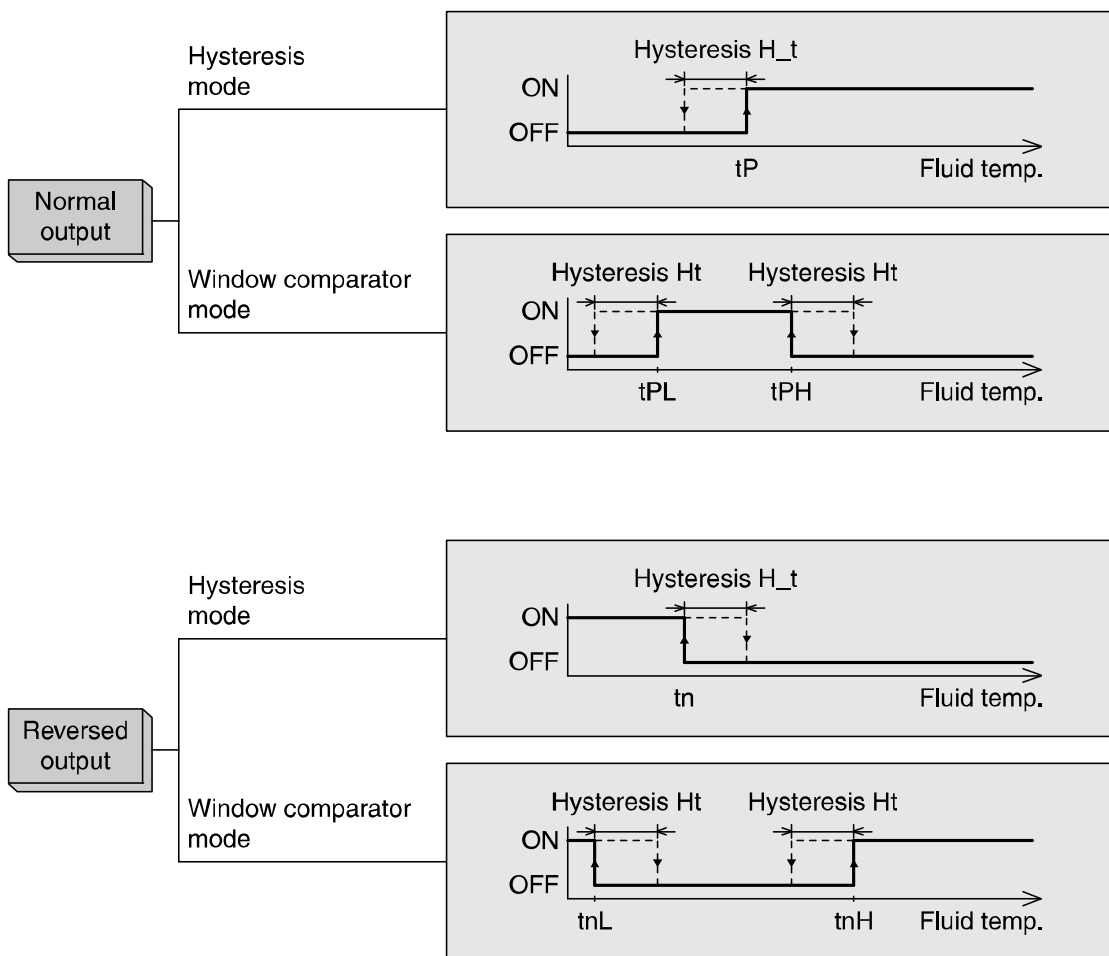



■[F3] Response time setting

The response time of the switch output can be set.

Appropriate setting of the response time can prevent the switch output from chattering.

<Operation>

Press the  or  button in function selection mode to display [F 3] on the main screen.

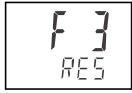



➔ The sub screen alternately displays [RES] and the current set value.

↓ Press the  button.

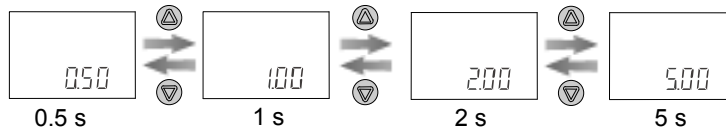

➔ Sub screen



Press the  or  button to select the response time.

Press the  button to confirm. ↓ Return to the function selection mode.

[F3] Response time setting is completed.

■[F10] Selection of sub screen

The display shown on the sub screen during measurement mode can be set.

- Switch point value display: Displays the set value for switch point of OUT1.
(The set value for the switch point of OUT2 can not be displayed.)
- Accumulated value display: Displays the accumulated value of OUT1.
(The accumulated value of OUT2 can not be displayed.)
- Bottom value display: Displays the minimum measured flow rate value since the last reset.
- Peak value display: Displays the maximum measured flow rate value since the last reset.
- Display of line name: Displays the name of the line.
- Fluid temperature display: Shows fluid temperature
- Temperature bottom display: The bottom value of fluid temperature is displayed.
- Temperature peak display: The peak of fluid temperature is displayed.
- OFF: Displays nothing

<Operation>

Press the or button in function selection mode to display [F10] on the main screen.

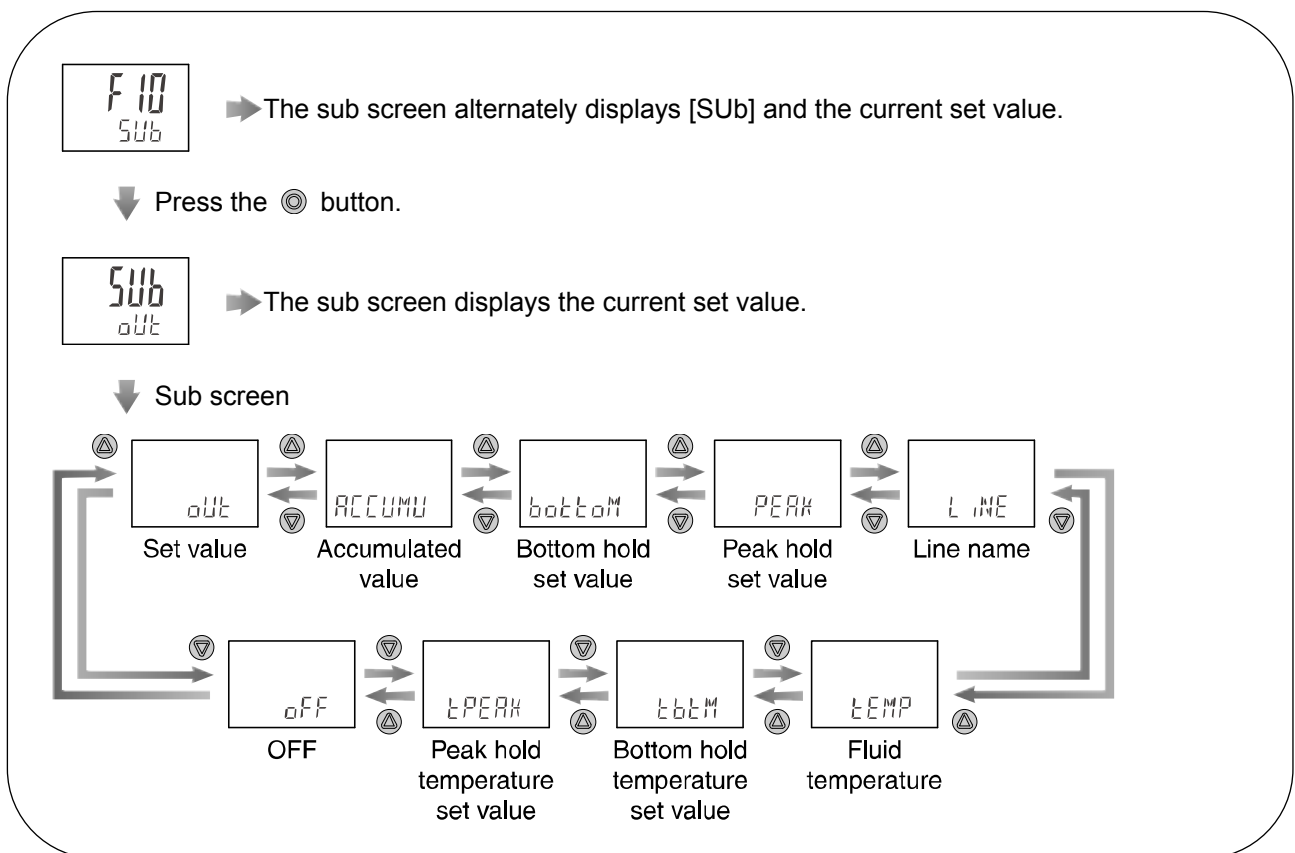

Press the or button to select the display.

Press the button to confirm. Return to the function selection mode.

[F10] Selection of sub screen is completed

* Temperature peak, temperature bottom, and fluid temperature display are features which are not used for this product.

<Example of sub screen display>

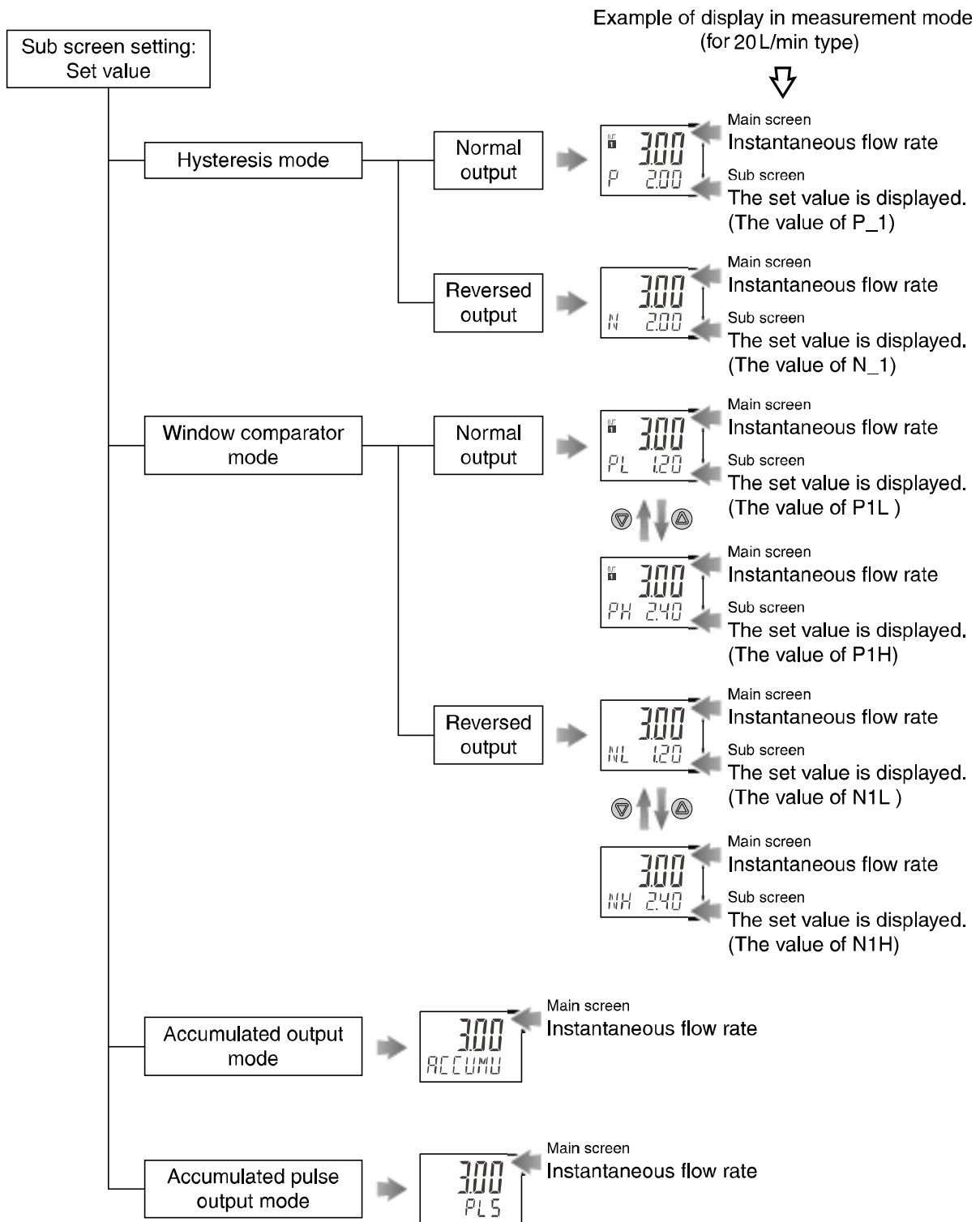

<Example of sub screen display (continued)>

Sub screen setting:
Accumulated value

Accumulated increment mode

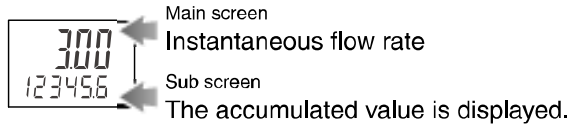

- The accumulated value increases according to the instantaneous flow.
- When the value exceeds 999999 L, the higher 3 digits (1.5 s) and lower 6 digits (3 s) are displayed alternately.
- When 999999999 L is reached, the display stops with [999999999] flashing.
Accumulation will start automatically in measurement mode after the power is supplied.
(When the option to memorize the cumulated value is selected, it will start from the memorized value. (Refer to [F30] Storing of accumulated flow.))
- Pressing the and button for 1 second resets the accumulated value (to 0).

Accumulated decrement mode

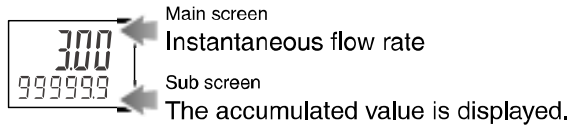

- The accumulated value decreases from the set value according to the instantaneous flow.
- When the value exceeds 999999 L, the higher 3 digits (1.5 s) and lower 6 digits (3 s) are displayed alternately.
- Below 999999 L, only the lower 6 digits are displayed.
When the accumulated value decreases to 0, the display stops with [0] flashing.
Accumulation will start automatically in measurement mode after the power is supplied.
(When the option to memorize the cumulated value is selected, it will start from the memorized value. (Refer to [F30] Storing of accumulated flow.))
- Pressing the and buttons for 1 second resets the accumulated value (to the set value).

<Example of sub screen display (continued)>

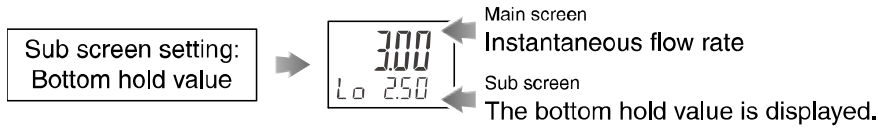
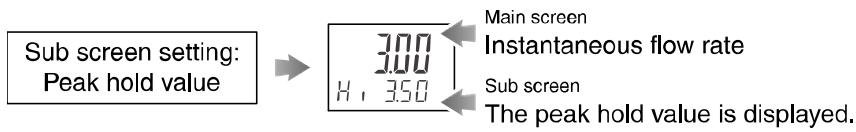

The maximum (peak) and minimum (bottom) flow from when the power is supplied to this moment is detected and updated.

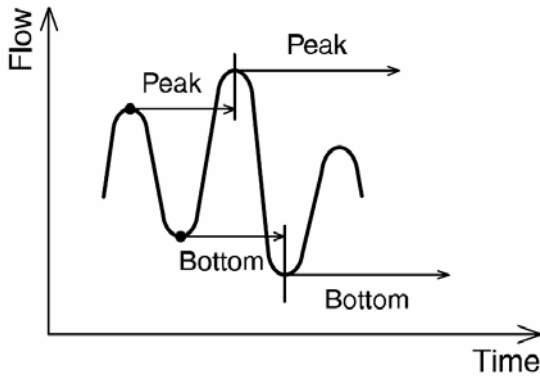

- Pressing the  and  buttons for 1 second clears the peak and bottom values.



The name of the piping line where the product is installed can be displayed. Refer to [F82] Input of line names on page 50 for how to input the line name.

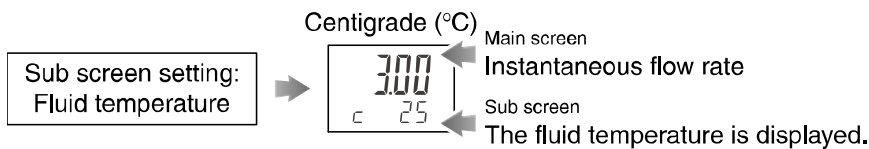

If a fluid temperature sensor is attached, the fluid temperature can be displayed as well. The left most digit shows Centigrade (°C).



The sub screen can be turned off.

- [F20] Setting of external input
This item is not used for this specification.



■ [F22] Setting of analogue output

This function can be used only when the optional analogue output is present.

If the optional temperature sensor is fitted, the analogue output of fluid temperature can be selected.

The flow that generates the output voltage (= 5 V) or output current (= 20 mA) at the span side of analogue output can be variable.

<Operation>

Press the  or  button in function selection mode to display [F22] on the main screen.

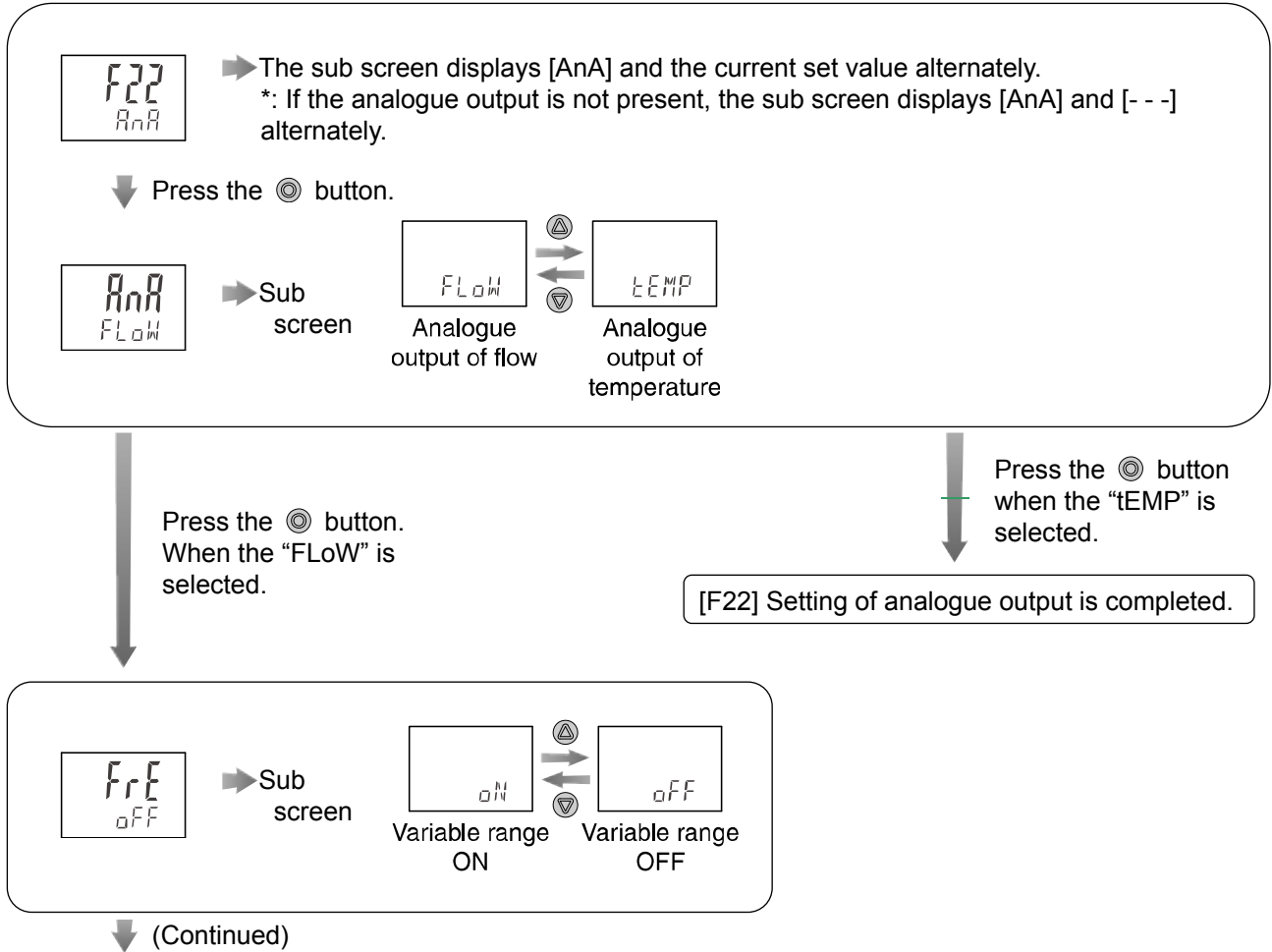

* Temperature analogue output is not used for this product.

■ [F30] Storing of accumulated flow

The default setting is to clear the accumulated flow value when the power supply is turned off. In the default setting, the accumulated flow value is not held when the power supply is turned off. The maximum writable limit of the memory device is 1 million cycles, which should be taken into consideration. If the product is operated 24 hours per day, the product life will be as follows:
 Data memorized every 5 minutes --- 5 minutes x 1 million cycles = 5 million minutes = 9.5 years
 Data memorized every 2 minutes --- 2 minutes x 1 million cycles = 2 million minutes = 3.8 years

<Operation>

Press the or button in function selection mode to display [F30] on the main screen.

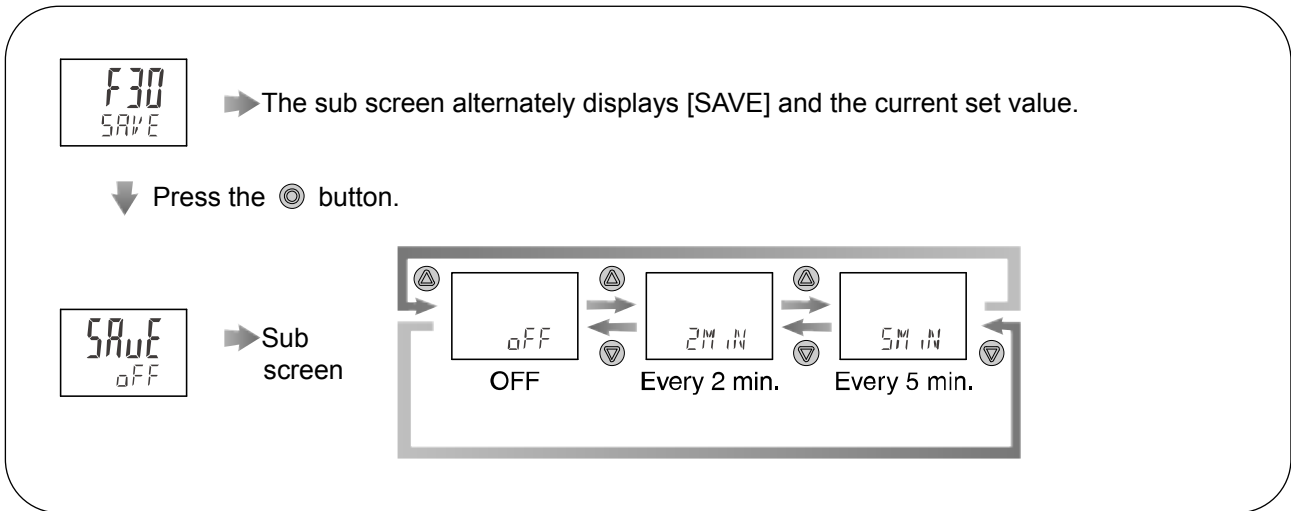

Press the or button to select the setting for storing accumulated flow.

Press the button to confirm. Return to the function selection mode.

[F30] Setting of accumulated flow storing function is completed.

*: Data memorization is performed every 2 or 5 minutes (depending upon the setting chosen), this means that the accumulated flow value for up to 2 or 5 minutes before the power supply is turned off will not be added to the device memory.

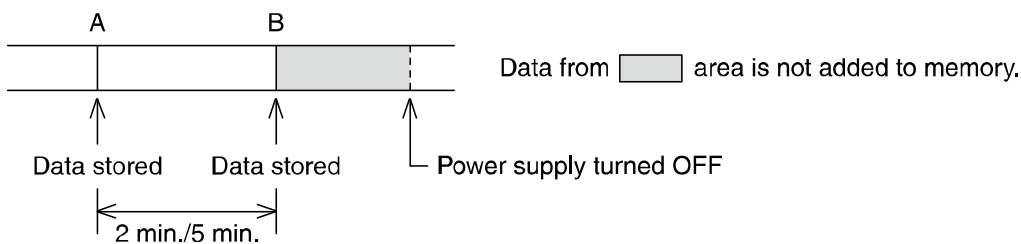

When the power supply is turned on again, the accumulated flow count will start from the last value recorded at B.

■[F80] Setting of power saving mode



The display can be turned off to reduce power consumption. (Reduced by approx. 12%)

When this function is selected, if no buttons are pressed for 30 seconds, the display will enter power saving mode.

While the display is off, the decimal points of the main display will flash.

In the default setting, power saving mode is OFF (normal mode).

<Operation>

Press the  or  button in function selection mode to display [F80] on the main screen.



➔ The sub screen alternately displays [dSP] and the current set value.

↓ Press the  button.



➔ Sub screen

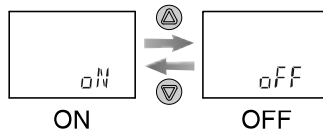

The display can be turned off to save power.

Press the  or  button to select the power saving mode setting

Press the  button to confirm. ↓ Return to the function selection mode.

[F80] Setting of power saving mode is completed

In power saving mode, the decimal points on the main display will flash. When any button is operated, the display will turn on. If no button operation is performed for another 30 seconds the display will turn off again.



■[F81] Setting of security code

Select whether a security code must be entered to unlock the keys.

For the key-lock function, refer to page 58.

In the default setting, security code entry is not necessary.

<Operation>

Press the  or  button in function selection mode to display [F81] on the main screen.



➔ The sub screen displays [PiN] and the current set value in turn.

↓ Press the  button.

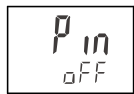

➔ Sub screen

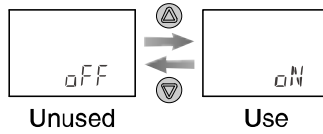

Press the  or  button to select the setting of security code.



Press the  button to confirm. ↓ Return to the function selection mode.

[F81] Setting of security code is completed

■[F82] Input of line names

A line name can be input (up to 6 characters and/or numbers).
The sub screen setting can be changed to show a line name.
(Refer to [F10] Selection of sub screen display on page 40.)

<Operation>

Press the  or  button in function selection mode to display [F82] on the main screen.

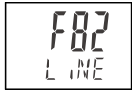

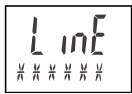

➡ The sub screen displays [LINE] and the line name alternately.

↓ Press the  button.



➡ Sub screen

The left most digit starts flashing. Select the required character from space→A→b→C X→y→Z→0→1 8→9→_→—→_→/→*→space→A by pressing  or  buttons.

Press the  button. (Less than 1second.) ↓ The next digit to the right will flash and can be edited.
(Follow the same procedure for the remaining digits)



After all 6 digits are input

Press the  button for 1 seconds or longer. ↓ Flashing stops.

Press the  button to confirm. ↓ Return to the function selection mode.

[F82] Input of line name is completed

A dot "." can be displayed at the bottom left of each digit

During setting, when the appropriate digit is flashing, press the  and  buttons simultaneously for 1 second or longer. A dot will be displayed.

To remove the dot, perform the same button operation.

■ [F90] Setting of all functions

All functions can be set one after the other, without having to select each one separately from the function selection mode.

<Operation>

Press the or button in function selection mode to display [F90] on the main screen.

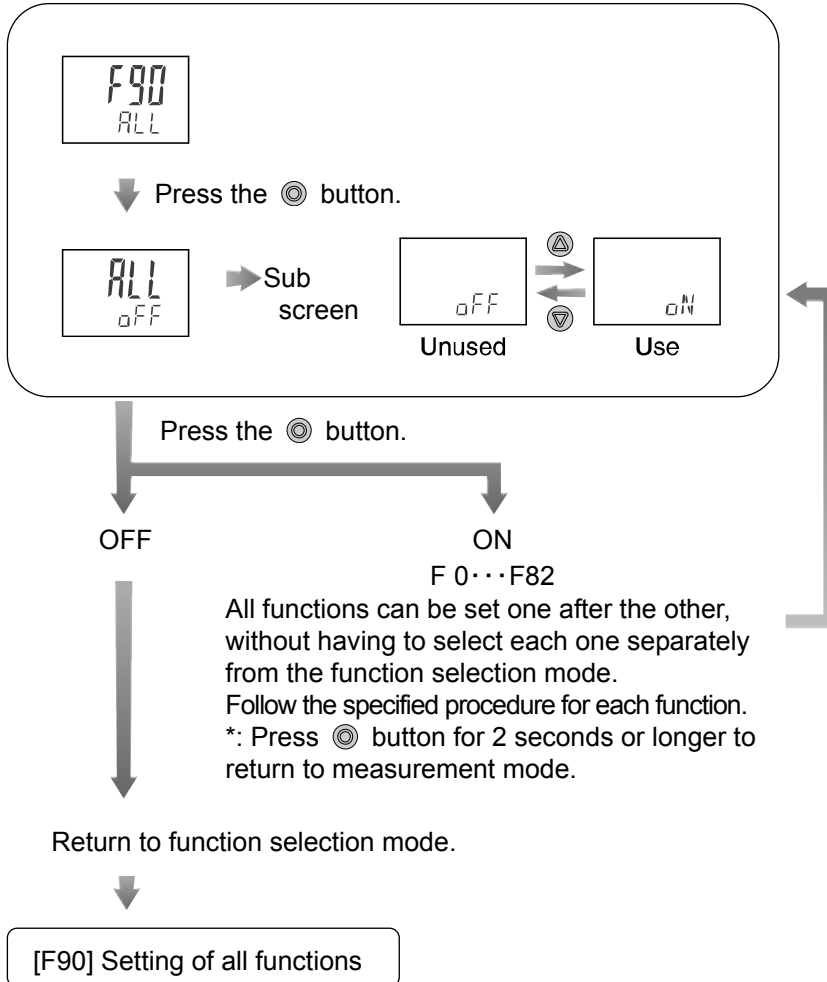



■[F96] Input value check

It is possible to check the voltage values (sensor output values) input to INPUT 1 and 2.

<Operation>

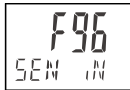
Press the  or  button in function selection mode to display [F99] on the main screen.



↓ Press the  button.

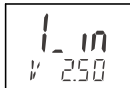

Displays the voltage value currently selected on the sub screen.

↓ Press the  button.

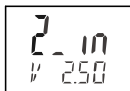

Displays the voltage value currently selected on the sub screen.

Press the  button to select INPUT 1 or INPUT2.

Press the  button to confirm. ↓ Return to the function selection mode.

[F96] Input value check is completed

*: If zero is input to INPUT1 and INPUT2, the input displayed may not be zero due to the adjustment error of the electric circuit. However, this is not an error. When input values are entered, they will be displayed correctly.

■[F97] Selection of copy function

The set values can be copied. The set values of flow rate and functions (except for fine adjustment of display value) can be copied. When the output specifications (switch output or analogue output) and/or unit specifications are the same, this function becomes available. The set value can be copied up to 10 switches simultaneously.

<Connection>

The power supply should be turned off before connecting the pressure switches.

Connect the master flow monitor and the slave flow monitors with copy lead wire (ZS-40-Y), and turn on the power supply.

The master flow monitor is the flow monitor from which the setting is copied.

The slave flow monitor is the monitor to which the setting is copied.

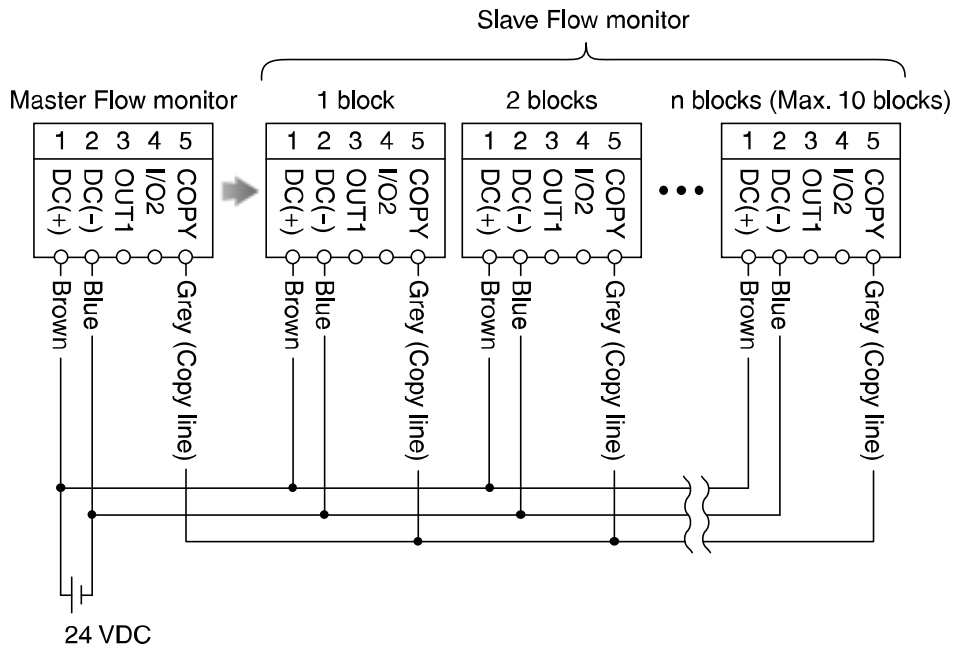



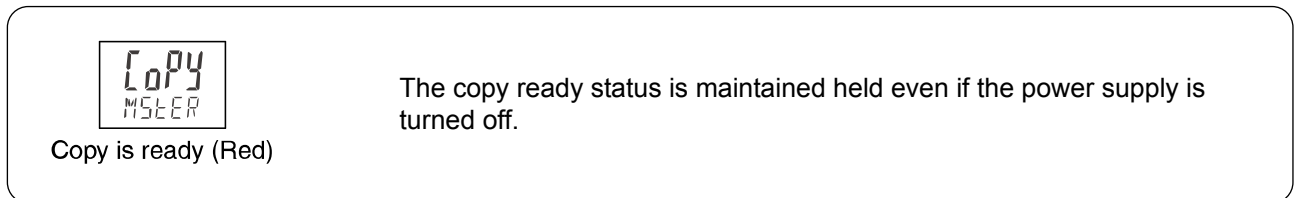
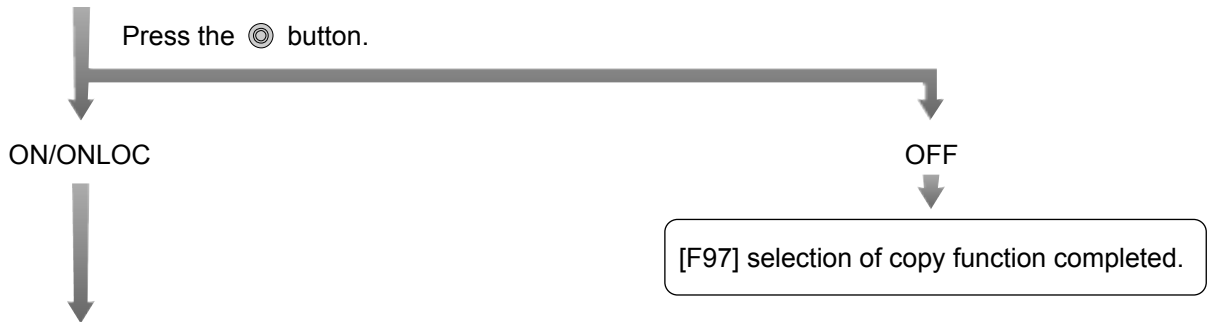
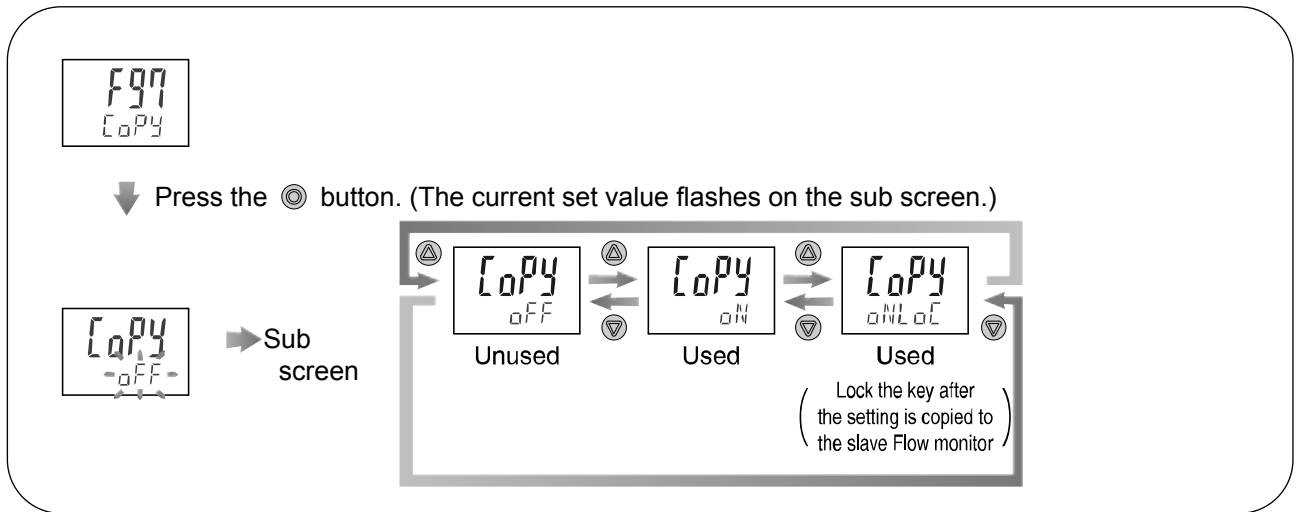

<Operation>

Press the or buttons to operate the master flow monitor in the function selection mode, and display [F97] on the main screen.

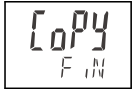

Press the button to start copying. (continued on next page)

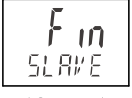
	Master flow monitor	Slave flow monitor
Sending/Receiving	 Blinks* (Red)	 Blinks* (Green)
Copy completed	 ON (Red)	Displayed alternately  ↔  (Green)

*They may not flash due to the timing.

⊙ Press the button

Successive copying is possible
The copy ready status is maintained held even if the power supply is turned off.



Copy is ready (Red)

When completing copy function, press the ▲ and ▼ buttons simultaneously for 1 second at least.

*: Press the ▲ and ▼ buttons simultaneously for 1 seconds at least.

Press the ⊙ button

[F97] selection of copy function is completed.

Return to measurement mode.

*: If the copy to the slave flow monitor is not completed, it is detected as a copying function sending/receiving error. Press the ▲ and ▼ buttons simultaneously for 1 second at least to return to measurement mode. Then check the wiring of the switches and retry the copy function.

■[F98] Output check

The output check can be turned on irrespective of flow conditions so that the circuit wiring can be checked. For the analogue output type, when ON the output will be 5 V or 20 mA , and when OFF 1 V or 4 mA.

<Operation>

Press the or button in function selection mode to display [F98] on the main screen.

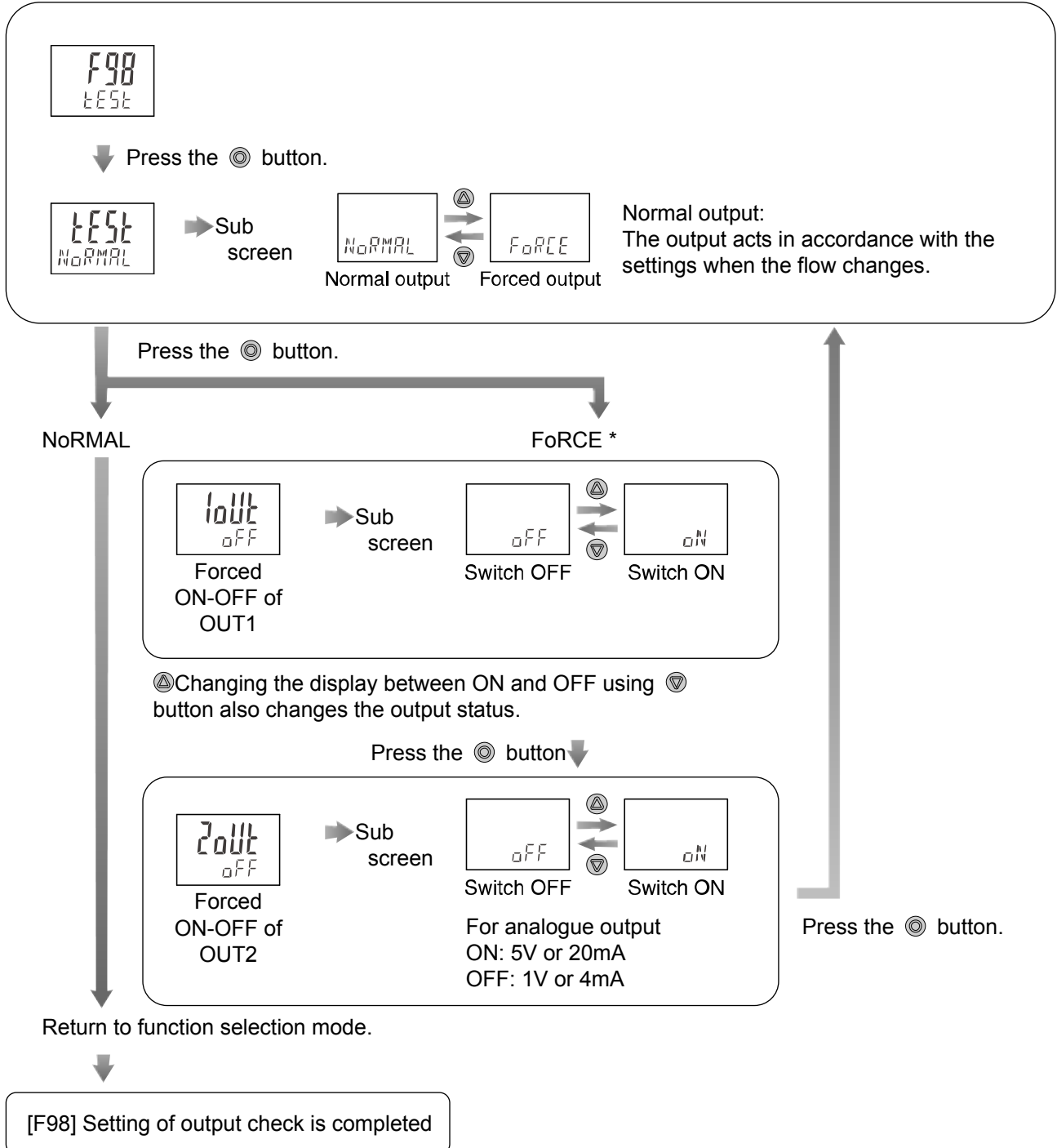



*: Press button for 2 seconds or longer to return to measurement mode.

*: An increase or decrease in flow will have no effect on the output while the output check is being performed.

■[F99] Reset to the default settings



The product can be returned to the default settings.

<Operation>

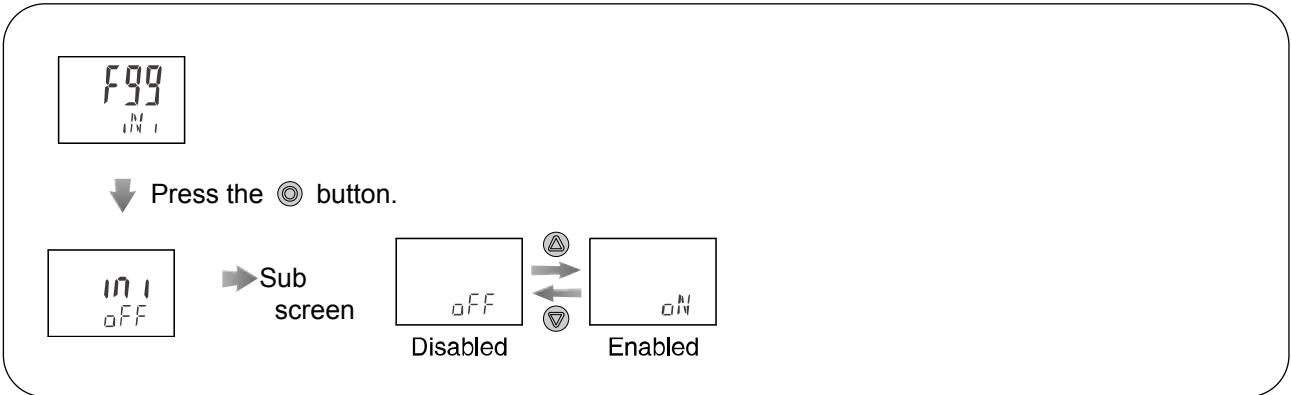
Press the  or  button in function selection mode to display [F99] on the main screen.



Press  or  button to display "ON".

Press the  and  button simultaneously for 5 seconds to restore the default settings.

*: Press  button for 1 second or longer, the display returns to measurement mode without changing the setting.

The device automatically returns to function selection mode.

[F99] Reset to the default settings is completed.

Other Settings

● Key lock

The key-lock function is used to prevent errors occurring due to unintentional changes of the set values. During key lock setting, it is possible to change the display (simple display of set value <--> sub screen)

<Operation with keys locked>

Simple check of set values

If the  button is pressed, [LoC] is displayed on the sub screen for approximately 1 second.

When the  button is released with [LoC] displayed, the sub screen will scroll through the set values.

After the scrolling of set values is finished, [LoC] is displayed for approx. 1 second, the Flow switch then returns to measurement mode.



Pressing the  or  buttons will change the sub screen display.

* The peak and bottom hold values and the accumulated flow can be viewed, but not cleared.

< Operation – Without security code input >

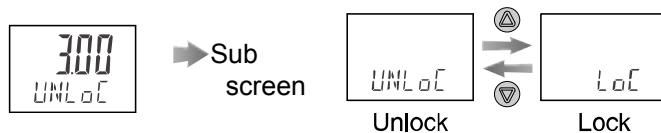
1. Press and hold the  button for 5 seconds or longer in measurement mode.
The current setting [LoC] or [UNLoC] will be displayed on the sub screen.



2. Press either the  or  button to select locking/unlocking the keys.
3. Press the  button to confirm. Return to the measurement mode.

To release key-lock, repeat the above operation.

The keys cannot be locked or released while the sub screen is displayed the set values under this function. Perform the operation in measurement mode.



< Operation – With security code input >

The procedure to lock the keys is the same as that for "without security code".

• Unlocking

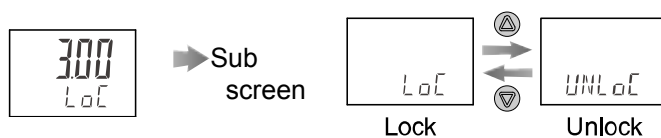
1. Press the  button for 5 seconds or longer in measurement mode.
[LoC] will be displayed on the sub display.



2. Press either  or  button to select unlocking the keys [UNLoC].
3. After the  button is pressed, the security code must be input.

4. Input of security code (3 digit setting)

The first digit will start flashing.

▲ Press the ▼ button to change the value.

◎ Press the S button to make the next value to the right flash.
(If the ◎ button is pressed on the far right digit, the hundreds digit will flash)

After the input is complete, press and hold the ◎ button for 1 second or longer.

(If no key operation is performed for 30 seconds during input or change of the security code, the display will return to measurement mode with LoC status.)

If the password is wrong, [FAL] will be displayed on the sub screen.

In this case, input the password again.

If an incorrect security code is entered 3 times, the display will return to measurement mode with LoC status.

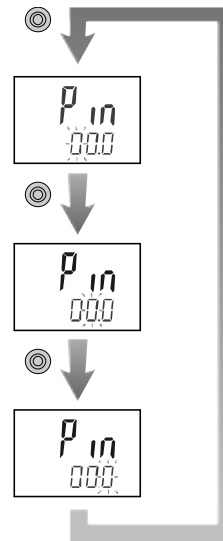

➡ [UNLoC] is displayed on the sub screen.

↓
Press the ◎ button to complete the unlocking operation.

• Change of security code

In the default setting, the security code is set to [000], but this can be changed to any number.

<Operation>

1. After the key lock setting is completed, perform all four steps in the key unlocking procedure. (Refer to Key-lock function on page 58).
2. When [UNLoC] is displayed in the sub screen, press ◎ and ▼ buttons simultaneously for 5 seconds or longer.

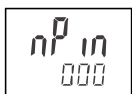

➡ [000] is displayed on the sub screen and the new security code should be entered.
For how to input the security code, refer to "4" Input of security code on page 59.

↓ Press the ◎ button for 1 seconds or longer.

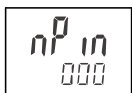

➡ The new security code is displayed on the sub screen.

↓ Press the ◎ button for 1 seconds or longer.

The change of security code is complete.

The status remains [UNLoC] after the change is completed, so perform the key lock setting again to change it to [LoC].

Maintenance

How to reset the product after a power cut or when the power has been unexpectedly removed

The settings of the product are retained from before the power cut or de-energizing.

The output condition also recovers to that before power cut or de-energizing, but may change depending on the operating environment. Therefore, check the safety of the whole installation before operating the product.

Troubleshooting

Troubleshooting

Applicable Flow switch: LFE series

If an operation failure occurs with the product, use the chart below to find out the cause of problem.

If a cause applicable to the failure cannot be identified and normal operation can be recovered by replacement with a new product, this indicates that the product itself was faulty. The damage to the product may have been caused by operating environment (network construction, etc.). Consult with SMC separately to obtain countermeasures.

Cross-reference for troubleshooting

Fault	Problem	Possible cause	Investigation method	Countermeasure
Incorrect display	No display.	Incorrect wiring	Check that the brown wire is connected to DC (+), blue wire is connected to DC (-).	Check and correct the wiring.
		Loose connector	Check the connection of the connector.	Connect the connector.
	Unstable display	Insufficient water supply	- Confirm whether the fluid path is full.	Fill up the fluid path.
		Pulsation in the flow.	Confirm whether the supply pressure fluctuates, or whether pulsation is generated due to the characteristics of the compressor or pump used as the pressure source.	Change to a pump with less pulsation. Install a tank to reduce the pressure fluctuation. Change the piping to elastic piping such as rubber hose.
	Incorrect display	The piping is connected in the wrong direction.	Confirm if the mounting direction is aligned with the flow direction.	Align the direction of the mounting and flow.
		Insufficient water supply	- Confirm whether the fluid path is full.	Fill up the fluid path.
		The flow rate range of the product to be connected is selected incorrectly.	Confirm whether the flow rate range is correctly selected.	Select the correct flow rate range.

Fault	Problem	Possible cause	Investigation method	Countermeasure
Output signal is abnormal	No output	Incorrect wiring	Check if the brown wire DC (+), blue wire DC (-) and white wire (OUT2) are connected.	Check and correct the wiring.
		Loose connector	Check the connection of the connector.	Connect the connector.
	Unstable output	Foreign matters in the sensor fluid path.	Check the presence of foreign matter	Remove foreign matter.
		Insufficient water supply	- Confirm whether the fluid path is full.	Fill up the fluid path.
		Pulsation in the flow.	Confirm whether the supply pressure fluctuates, or whether pulsation is generated due to the characteristics of the compressor or pump used as the pressure source.	Change to a pump with less pulsation. Install a tank to reduce the pressure fluctuation. Change the piping to elastic piping such as rubber hose.
		Hysteresis is too small.	Confirm to what level the hysteresis is set.	Increase the hysteresis.
The push buttons do not work	The push buttons do not react.	Key-lock mode is activated.	Check if "LoC" is displayed when the button is pressed.	Unlock the keys. (Page 58)

Error Display Function

Error Name	Display	Description	Measures
OUT1 over current error	Er 1	A load current of 80 mA or more is flowing to the switch output (OUT1).	Turn the power off and remove the cause of the over current. Then turn the power on again.
OUT2 over current error	Er 2	A load current of 80 mA or more is flowing to the switch output (OUT2).	
Excessive instantaneous flow	HHH	The applied flow rate is above approx. 120% of the rated flow rate.	Reduce the flow.
Sensor disconnection error	LLL	The remote sensor is not connected to the monitor. Or sensor output is below 0.6V.	Connect the sensor, or check the sensor output voltage.
Excessive accumulated flow	 (Displays in turn)	The accumulated flow range has been exceeded. (In some flow ranges, the decimal point may flash.)	Reset the accumulated flow. (This will not be a problem if the accumulated flow is not used.)
Exceeding upper limit of the temperature	cHHH	The fluid temperature is above 110°C.	Reduce the fluid temperature.
Temperature sensor is not connected	cLLL	The temperature sensor output line is not connected.	—
System error	Er 0	Displayed if an internal data error has occurred.	Turn the power off and turn it on again. If the failure cannot be solved, contact SMC.
	Er 4		
	Er 6		
	Er 8		

If the error cannot be reset after the above measures are taken, then please contact SMC

Specifications

■ Specifications

Specification of the product

Model	LFE0□																													
Display range	0.4 to 24.0 L/min (Displays 0.0 when the value is below 0.4 L/min.)	2.0 to 120.0 L/min (Displays 0.0 when the value is below 2.0 L/min.)	4 to 240 L/min (Displays 0 when the value is below 4 L/min.)																											
Set point range	0.4 to 24.0 L/min	2.0 to 120.0 L/min	4 to 240 L/min																											
Min. setting unit	0.1 L/min	0.5 L/min	1 L/min																											
Accumulated volume per pulse (Pulse width=50ms)	0.1 L/pulse	0.5 L/pulse	1 L/pulse																											
Display unit	Instantaneous flow L/min, accumulated flow L																													
Accuracy	Display value: $\pm 0.5\%$ F.S. Analogue output: $\pm 0.5\%$ F.S.																													
Repeatability	$\pm 0.5\%$ F.S.																													
Temperature characteristics	$\pm 0.5\%$ F.S.(25 °C reference)																													
Accumulated flow range* ¹	99999999.9 L	999999999 L																												
	By 0.1L	By 1L																												
Switch output	NPN or PNP open collector output																													
<table border="1"> <tr> <td>Maximum load current</td> <td colspan="3">80 mA</td> </tr> <tr> <td>Maximum applied voltage</td> <td colspan="3">28 VDC</td> </tr> <tr> <td>Internal voltage drop</td> <td colspan="3">NPN: 1 V max. (at 80 mA load current) PNP: 1.5 V max. (at 80 mA load current)</td> </tr> <tr> <td>Response time*²</td> <td colspan="3">0.5 s/1 s/2 s/5 s</td> </tr> <tr> <td>Output protection</td> <td colspan="3">Short circuit protection</td> </tr> <tr> <td rowspan="2">Output Mode</td> <td>Flow</td> <td colspan="2">Hysteresis mode, Window comparator mode, Accumulated output mode or Accumulated pulse output mode</td> </tr> <tr> <td>Temp.</td> <td colspan="2">Selects the output for fluid temperature (hysteresis mode or window comparator mode).</td> </tr> </table>	Maximum load current	80 mA			Maximum applied voltage	28 VDC			Internal voltage drop	NPN: 1 V max. (at 80 mA load current) PNP: 1.5 V max. (at 80 mA load current)			Response time* ²	0.5 s/1 s/2 s/5 s			Output protection	Short circuit protection			Output Mode	Flow	Hysteresis mode, Window comparator mode, Accumulated output mode or Accumulated pulse output mode		Temp.	Selects the output for fluid temperature (hysteresis mode or window comparator mode).				
	Maximum load current	80 mA																												
	Maximum applied voltage	28 VDC																												
	Internal voltage drop	NPN: 1 V max. (at 80 mA load current) PNP: 1.5 V max. (at 80 mA load current)																												
	Response time* ²	0.5 s/1 s/2 s/5 s																												
	Output protection	Short circuit protection																												
Output Mode	Flow	Hysteresis mode, Window comparator mode, Accumulated output mode or Accumulated pulse output mode																												
	Temp.	Selects the output for fluid temperature (hysteresis mode or window comparator mode).																												
Analogue output	Response time* ³	0.5 s/1 s/2 s/5 s																												
	Voltage output	Output voltage: 1 to 5 V, Output impedance: 1 k Ω min.																												
	Current output	Output current : 4 to 20 mA Max. load impedance 600 Ω																												
Hysteresis	Variable																													
Input and output	Input for copy mode																													
Display type	2 screen display (Main screen: 4 digit, 7-segment, 2 colour; red/green, Sub screen: 6 digit, 11 segment, White) Display updating interval 5 times/sec.																													
Operation LED	Output 1 and 2: Orange																													
Power supply voltage	DC24 V $\pm 10\%$																													
Current consumption	50 mA or less																													
Connection method	Power supply output 5P connector, sensor connection 4P connector (e-con)																													

Model		LFE0□
Environmental	Enclosure	IP40 (Note that the display front is only certified as IP65 by using optional parts (panel mount adapter and waterproof seal).
	Operating temperature range	0 to 50°C (No condensation or freezing)
	Ambient humidity range	Operation, Storage: 35 to 85%RH (No condensation)
	Withstand voltage	1000 V AC for 1 minute between external terminals and FE
	Insulation resistance	50 MΩ or more (at 500VDC) between external terminals and case
Standards		CE marking, UL (CSA), RoHS
Weight	Without lead wire	50 g
	With lead wire	100 g

- *1: The response time will be cleared by turning off the power supply. It is possible to select the function to memorize it. (Every 2 or 5 minutes)
When 5 minutes interval is selected, take into consideration the maximum number of times it is possible to write to the memory device (electronic part), which is 1 million times (5 minutes x 1 million times = 5 million minutes = Approx. 9.5 years for 24 hour energizing).
Calculate the life in your operating conditions before using the memorizing function and use within this range.
- *2: The response time is when the set value is 63% in relation to the step input. (7 seconds for temperature sensor)
- *3: The response time is when the set value reaches 63% in relation to the step input. Linked with the switch output.

Specifications of lead wire (ZS-40-W)

Item		Specifications
Conductor	Nominal cross section	AWG26
	O.D.	Approx. 0.51 mm
Insulator	Material	Bridge vinyl
	O.D.	Approx. 1.00 mm
	Colours	Brown, blue, black, white, grey
Sheath	Material	Heat and oil resistant plastic
Finished O.D.		ø3.5 mm

■ Analogue output

Flow/Analogue output

	A	B	C
Voltage output	1 V	1.1 V	5 V
Current output	4 mA	4.4 mA	20 mA

Sensor	Rated flow [L/min]	
	Minimum	Maximum
LFE1	0.5	20
LFE2	2.5	100
LFE3	5	200

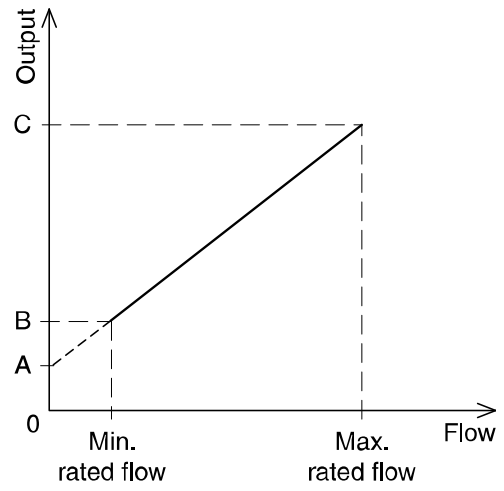

■ Dimensions

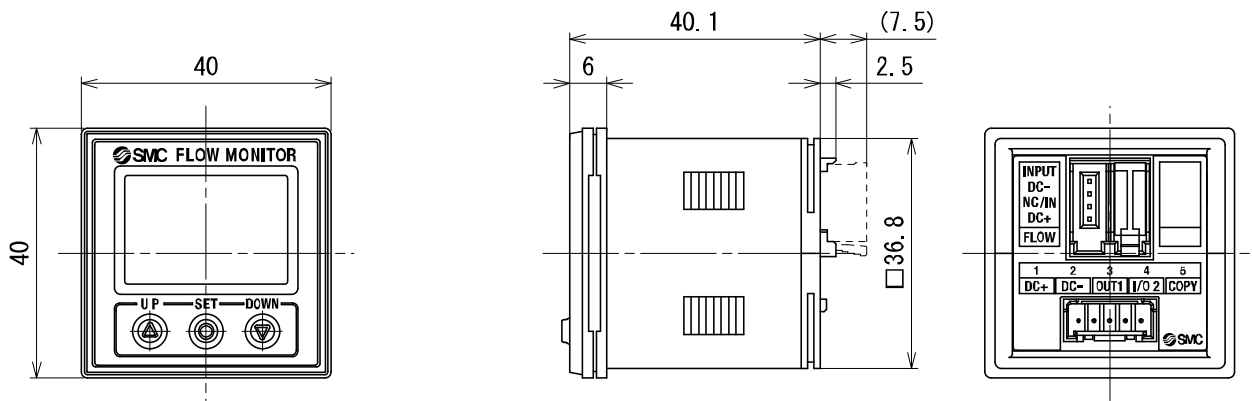

Front protective cover + Panel mount adapter

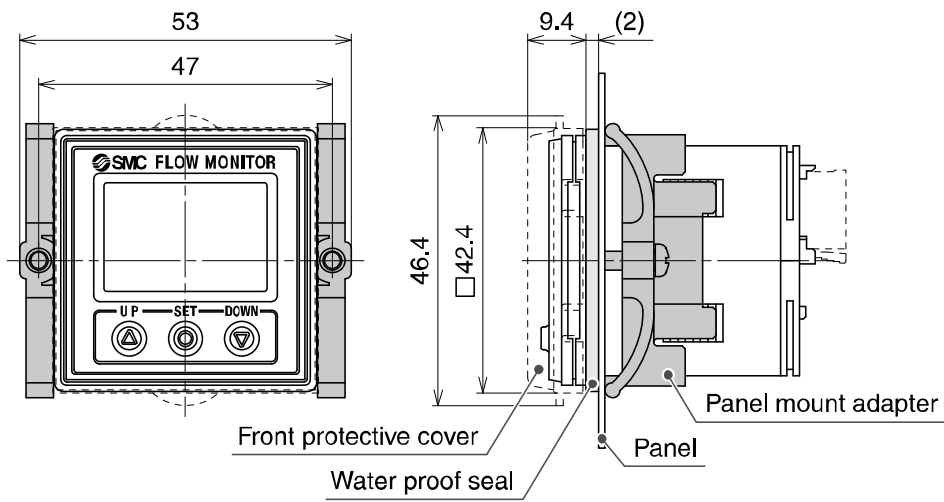

Cut-out dimensions for panel mounting

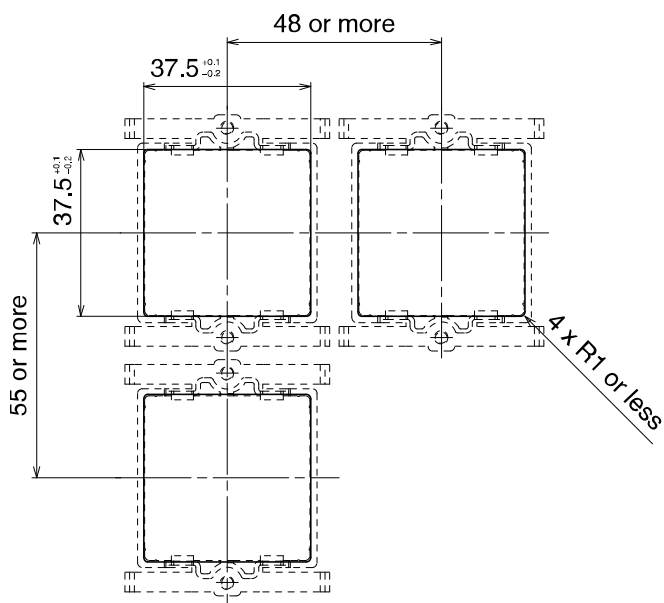

*: The thickness of the panel is 0.5 to 0.8mm (with a waterproof seal: 0.5 to 6mm).

Dimensions of power supply/output lead wire (ZS-40-W)

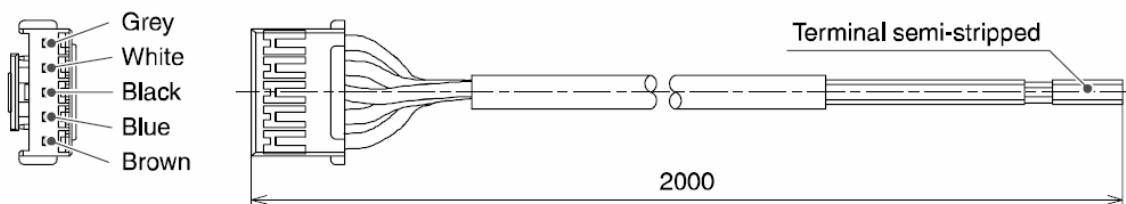

Revision history

SMC Corporation

4-14-1, Sotokanda, Chiyoda-ku, Tokyo 101-0021 JAPAN

Tel: + 81 3 5207 8249 Fax: +81 3 5298 5362

URL <http://www.smcworld.com>

Note: Specifications are subject to change without prior notice and any obligation on the part of the manufacturer.

© 2012 SMC Corporation All Rights Reserved

