



Operation Manual

PRODUCT NAME

Digital Flow Switch
(Remote type monitor unit)

MODEL / Series / Product Number

PF3W3##

SMC Corporation

Table of Contents

Safety Instructions	2
Model Indication and How to Order	9
Summary of Product parts	12
Definition and terminology	13
Mounting and Installation	15
Installation	15
Wiring	16
Flow Setting	21
Function Setting	24
Default settings	25
F0 Selection of sensor	26
F1 Setting of OUT1	27
F2 Setting of OUT2	35
F3 Response time setting	41
F10 Selection of sub screen	42
F20 Setting of external input	46
F22 Setting of analogue output	47
F30 Storing of accumulated flow	49
F80 Setting of power saving mode	50
F81 Setting of security code	51
F82 Input of line names	52
F90 Setting of all functions	53
F96 Input value check	54
F97 Selection of copy function	55
F98 Output check	58
F99 Reset to the default settings	59
Other Settings	60
Maintenance	63
Troubleshooting	64
Specification	67
Specifications	67
Characteristics graph	70
Dimensions	71



Safety Instructions

These safety instructions are intended to prevent hazardous situations and/or equipment damage. These instructions indicate the level of potential hazard with the labels of "Caution", "Warning" or "Danger". They are all important notes for safety and must be followed in addition to International Standards (ISO/IEC)*1, and other safety regulations.

*1) ISO 4414: Pneumatic fluid power -- General rules relating to systems.

ISO 4413: Hydraulic fluid power -- General rules relating to systems.

IEC 60204-1: Safety of machinery -- Electrical equipment of machines. (Part 1: General requirements)

ISO 10218: Manipulating industrial robots -Safety.

etc.



Caution

Caution indicates a hazard with a low level of risk which, if not avoided, could result in minor or moderate injury.



Warning

Warning indicates a hazard with a medium level of risk which, if not avoided, could result in death or serious injury.



Danger

Danger indicates a hazard with a high level of risk which, if not avoided, will result in death or serious injury.

Warning

1. The compatibility of the product is the responsibility of the person who designs the equipment or decides its specifications.

Since the product specified here is used under various operating conditions, its compatibility with specific equipment must be decided by the person who designs the equipment or decides its specifications based on necessary analysis and test results.

The expected performance and safety assurance of the equipment will be the responsibility of the person who has determined its compatibility with the product.

This person should also continuously review all specifications of the product referring to its latest catalog information, with a view to giving due consideration to any possibility of equipment failure when configuring the equipment.

2. Only personnel with appropriate training should operate machinery and equipment.

The product specified here may become unsafe if handled incorrectly.

The assembly, operation and maintenance of machines or equipment including our products must be performed by an operator who is appropriately trained and experienced.

3. Do not service or attempt to remove product and machinery/equipment until safety is confirmed.

1. The inspection and maintenance of machinery/equipment should only be performed after measures to prevent falling or runaway of the driven objects have been confirmed.

2. When the product is to be removed, confirm that the safety measures as mentioned above are implemented and the power from any appropriate source is cut, and read and understand the specific product precautions of all relevant products carefully.

3. Before machinery/equipment is restarted, take measures to prevent unexpected operation and malfunction.

4. Contact SMC beforehand and take special consideration of safety measures if the product is to be used in any of the following conditions.

1. Conditions and environments outside of the given specifications, or use outdoors or in a place exposed to direct sunlight.

2. Installation on equipment in conjunction with atomic energy, railways, air navigation, space, shipping, vehicles, military, medical treatment, combustion and recreation, or equipment in contact with food and beverages, emergency stop circuits, clutch and brake circuits in press applications, safety equipment or other applications unsuitable for the standard specifications described in the product catalog.

3. An application which could have negative effects on people, property, or animals requiring special safety analysis.

4. Use in an interlock circuit, which requires the provision of double interlock for possible failure by using a mechanical protective function, and periodical checks to confirm proper operation.



Safety Instructions

Caution

1. The product is provided for use in manufacturing industries.

The product herein described is basically provided for peaceful use in manufacturing industries. If considering using the product in other industries, consult SMC beforehand and exchange specifications or a contract if necessary.
If anything is unclear, contact your nearest sales branch.

Limited warranty and Disclaimer/Compliance Requirements

The product used is subject to the following "Limited warranty and Disclaimer" and "Compliance Requirements".

Read and accept them before using the product.

Limited warranty and Disclaimer

1. The warranty period of the product is 1 year in service or 1.5 years after the product is delivered, whichever is first.*2)

Also, the product may have specified durability, running distance or replacement parts. Please consult your nearest sales branch.

2. For any failure or damage reported within the warranty period which is clearly our responsibility, a replacement product or necessary parts will be provided.

This limited warranty applies only to our product independently, and not to any other damage incurred due to the failure of the product.

3. Prior to using SMC products, please read and understand the warranty terms and disclaimers noted in the specified catalog for the particular products.

***2) Vacuum pads are excluded from this 1 year warranty.**

A vacuum pad is a consumable part, so it is warranted for a year after it is delivered.

Also, even within the warranty period, the wear of a product due to the use of the vacuum pad or failure due to the deterioration of rubber material are not covered by the limited warranty.

Compliance Requirements

1. The use of SMC products with production equipment for the manufacture of weapons of mass destruction (WMD) or any other weapon is strictly prohibited.

2. The exports of SMC products or technology from one country to another are governed by the relevant security laws and regulation of the countries involved in the transaction. Prior to the shipment of a SMC product to another country, assure that all local rules governing that export are known and followed.

Caution

SMC products are not intended for use as instruments for legal metrology.

Products that SMC manufactures or sells are not measurement instruments that are qualified by pattern approval tests relating to the measurement laws of each country.

Therefore, SMC products cannot be used for business or certification ordained by the measurement laws of each country.

Operator

- ◆ This operation manual is intended for those who have knowledge of machinery using pneumatic equipment, and have sufficient knowledge of assembly, operation and maintenance of such equipment. Only those persons are allowed to perform assembly, operation and maintenance.
- ◆ Read and understand this operation manual carefully before assembling, operating or providing maintenance to the product.

■ Precautions

Warning

- Do not disassemble, modify (including changing the printed circuit board) or repair.
An injury or failure can result.
- Do not operate the product outside of the specifications.
Do not use for flammable or harmful fluids.
Fire, malfunction, or damage to the product can result.
Verify the specifications before use.
- Do not operate in an atmosphere containing flammable or explosive gases.
Fire or an explosion can result.
This product is not designed to be explosion proof.
- Do not use with flammable or highly permeable fluids.
Fire, explosion, damage or corrosion can result.
- Do not use the product in a place where static electricity is a problem.
Otherwise it can cause failure or malfunction of the system.
- If using the product in an interlocking circuit:
 - Provide a double interlocking system, for example a mechanical system.
 - Check the product regularly for proper operation.Otherwise malfunction can result, causing an accident.
- The following instructions must be followed during maintenance:
 - Turn off the power supply.
 - Ensure the flow is shut off before performing maintenance.Otherwise an injury can result.

Caution

- Do not touch the terminals and connectors while the power is on.
Otherwise electric shock, malfunction or damage to the product can result.
- Do not touch the piping or its connected parts when the fluid is at high temperature.
It may lead to burnt.
Ensure the piping cools sufficiently before touching.
- After maintenance is complete, perform appropriate functional inspections and leak tests.
Stop operation if the equipment does not function properly or there is a leakage of fluid.
When leakage occurs from parts other than the piping, the product might be faulty.
Disconnect the power supply and stop fluid supply.
Do not apply fluid under leaking conditions.
Safety cannot be assured in the case of unexpected malfunction.

■ NOTE

- Follow the instructions given below when designing, selecting and handling the product.
- The instructions on design and selection (installation, wiring, environment, adjustment, operation, maintenance, etc.) described below must also be followed.
 - * Product specifications
 - The direct current power supply to be used should be UL approved as follows.
Circuit (of class 2) which is of maximum 30 Vrms (42.4 V peak) or less, with UL 1310 class 2 power supply unit or UL 1585 class 2 transformer.
 - The product is a UL approved product only if it has a  mark on the body.
 - Use the specified voltage.
Otherwise failure or malfunction can result.
Insufficient supply voltage may not drive a load due to a voltage drop inside the product.
Verify the operating voltage of the load before use.
 - Do not exceed the specified maximum allowable load.
Otherwise it can cause damage or shorten the life of the product.
 - Input data to the product is not deleted, even if the power supply is cut off. (Number of times of rewriting: 1000000 times)
 - Reserve a space for maintenance.
Allow sufficient space for maintenance when designing the system.

●Product handling

*Installation

- Tighten to the specified tightening torque.

If the tightening torque is exceeded the mounting screws, brackets and the product can be broken. Insufficient torque can cause displacement of the product from its proper position and the looseness of the mounting screws. (Refer to "Mounting and Installation" on page 15.)

- Be sure to ground terminal FG when using a commercially available switch-mode power supply.

- Do not use in a place subject to heavy vibration and/or shock.

Otherwise damage to the internal parts can result, causing malfunction.

- Do not pull the lead wire forcefully, not lift the product by pulling the lead wire. (Tensile force 30 N or less)

Hold the body when handling to avoid the damage of the product.

The product will be damaged, leading to failure and malfunction.

- Never mount the product in a location that will be used as a scaffold.

The product may be damaged if excessive force is applied by stepping or climbing onto it.

*Wiring

- Do not pull the lead wires. In particular, never lift a product equipped with fitting and piping by holding the lead wires.

Otherwise damage to the internal parts can result, causing malfunction or disconnection from the connector.

- Avoid repeatedly bending, stretching or applying a heavy object or force to the lead wire.

Repetitive bending or tensile stress can cause the sheath of the wire to peel off, or break the wire.

If the lead wire can move, fix it near the body of the product.

The recommended bend radius of the lead wire is 6 times the outside diameter of the sheath, or 33 times the outside diameter of the insulation material, whichever is larger.

Replace a damaged lead wire with a new one.

- Wire correctly.

Incorrect wiring can break the product.

- Do not perform wiring while the power is on.

Otherwise damage to the internal parts can result, causing malfunction.

- Do not route wires and cables together with power or high voltage cables.

Otherwise the product can malfunction due to interference of noise and surge voltage from power and high voltage cables to the signal line. Route the wires (piping) of the product separately from power or high voltage cables.

- Confirm proper insulation of wiring.

Poor insulation (interference from another circuit, poor insulation between terminals, etc.) can lead to excess voltage or current being applied to the product, causing damage.

- Keep wiring as short as possible to prevent interference from electromagnetic noise and surge voltage.

Do not use a cable longer than 30 m.

Wire the DC(-) line (blue) as close as possible to the power supply.

- When the analogue output is used, install a noise filter (line noise filter, ferrite element, etc.) between the switch-mode power supply and this product.

*Environment

- Do not use the product in an environment that is constantly exposed to the splash of water.
Otherwise failure or malfunction can result. Take measures such as using a cover.
- Do not use the product in an environment where corrosive gases or fluids could be splashed.
Otherwise damage to the product and malfunction can result.
- Do not use in a place where the product could be splashed by oil or chemicals.
If the product is used in an environment containing oils or chemicals such as coolant or cleaning solvent, even for a short time, it may be adversely affected (damage, malfunction, or hardening of the lead wires).
- Do not use in an area where surges are generated.
When a machine or equipment generating large surge near the product (magnetic type lifter, high frequency inductive furnace, motor, etc.), this can result in malfunction (display of incorrect value), deterioration and damage of internal elements. Take measures against the surge sources, and prevent the lines from coming into close contact.
- Do not use a load which generates surge voltage.
When a surge-generating load such as a relay or solenoid is driven directly, use a Flow switch with a built-in surge absorbing element.
- The product is CE marked, but not immune to lightning strikes. Take measures against lightning strikes in the system.
- Mount the product in a location that is not affected by vibration or impact.
Otherwise failure or malfunction can result.
- Do not use the product in the presence of a magnetic field.
Such use can result in malfunction of the product.
- Do not let foreign matter, such as wire debris, get inside the product.
To prevent malfunction or failure take measures to prevent the debris entering the product.
- Do not use this product in places where there are cyclic temperature changes.
Heat cycles other than ordinary changes in temperature can adversely affect the inside of the product.
- Do not expose the product to direct sunlight.
If using in a location directly exposed to sunlight, shade the product from the sunlight.
Otherwise failure or malfunction can result.
- Keep within the specified ambient temperatures range.
Protection against freezing is necessary.
Avoid sudden temperature change even within specified temperature. Otherwise failure or malfunction can result.
- Do not operate close to a heat source, or in a location exposed to radiant heat.
This can cause operating failure.

*Adjustment and Operation

- Connect a load before turning the power supply on.
- Do not short-circuit the load.
Although error is displayed when the product load has a short circuit, generated over current lead to cause the damage of the product.
- Do not press the setting buttons with a sharp pointed object.
It may damage the setting buttons.
- Supply the power when there is no flow.
- The product is compulsory turned off for 3 seconds after the power is supplied.
- Perform settings suitable for the operating conditions.
Incorrect settings can cause operational failure.
For details of each setting, refer to page 21 to 62 of this manual.
- During the initial setting and flow rate setting, the product will switch the measurement output with the condition before setting.
Confirm the output has no adverse effect on machinery and equipment before setting.
Stop the control system before setting if necessary.
- Do not touch the LCD display during operation.
The display can vary due to static electricity.

*Maintenance

- Turn off the power supply, stop the fluid and check the safety before performing any maintenance.
There is a risk of unexpected malfunction.
- Perform regular maintenance and inspections.
There is a risk of unexpected malfunction of components due to the malfunction of equipment and machinery.
- Do not use solvents such as benzene, thinner etc. to clean the product.
They could damage the surface of the product and erase the indication on the product.
Use a soft cloth to remove stains. For heavy stains, use a cloth soaked with diluted neutral detergent and fully squeezed, then wipe up the stains again with a dry cloth.

Model Indication and How to Order

PF3W30 -

Separate type monitor part

Output specification

Symbol	OUT1	OUT2
A	NPN	NPN
B	PNP	PNP
C	NPN	Analogue 1 to 5 V
D	NPN	Analogue 4 to 20 mA
E	PNP	Analogue 1 to 5 V
F	PNP	Analogue 4 to 20 mA
G	NPN	External input
H	PNP	External input
J	Analogue 1 to 5 V	Analogue 1 to 5 V
K	Analogue 4 to 20 mA	Analogue 4 to 20 mA

*: When the flow sensor with a temperature sensor is connected, The temperature sensor output is available at OUT2 only.

Lead wire

Symbol	Content
Nil	Power and output lead wire (2 m)
N	None

Calibration certificate
(Only flow monitor)

Symbol	Content
Nil	None
A	With calibration certificate

*: Written in both Japanese and English.

Connector

Symbol	Content
Nil	None
C	Connector for sensor lead wire (1 pc.)

Panel mount

Symbol	Content
Nil	None
T	Panel mount adapter
V	Front protective cover + Panel mount adapter

Unit specification

Symbol	Instantaneous flow	Accumulated flow	Temp.
M	L/min	L	°C
G	gal/min	gal	°C
F	gal/min	gal	°F
J	L/min	L	°F

*: The symbol of G, F, J are specified to order.

Ref.: 1 [L/min] ⇔ 0.2642 [gal/min]

1 [gal/min] ⇔ 3.785 [L/min]

[°F] = 9/5 x [°C] + 32

*: For the remote sensor, select analogue output: 1 to 5 V type. Applicable sensor: PF3W5--1(T)

Connector

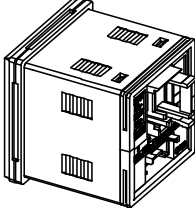
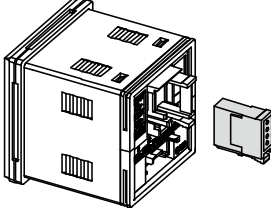
NIL	C
<p data-bbox="268 376 416 405">No connector</p> 	<p data-bbox="587 376 855 405">Sensor connector (1 pc.)</p> 

Panel mount

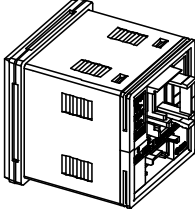
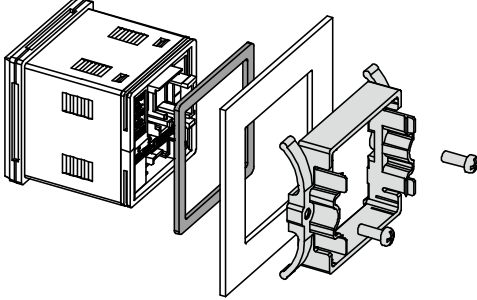
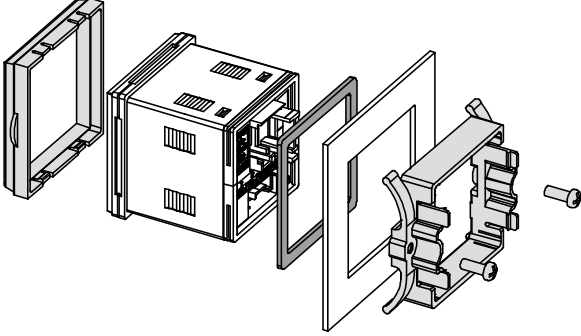
NIL	T
<p data-bbox="280 855 405 884">No adapter</p> 	<p data-bbox="799 855 1026 884">Panel mount adapter</p> 
<p data-bbox="715 1261 730 1283">V</p>	
<p data-bbox="480 1312 967 1341">Front protective cover + Panel mount adapter</p> 	

Options/Part number

If an option is required independently, order using the following part number.

Option	Part number	Remarks
Panel mount adapter	ZS-26-B	Waterproof seal with screws
Front protective cover + Panel mount adapter	ZS-26-C	Waterproof seal with screws
Protective cover only	ZS-26-01	Please order panel mount adapters etc. separately.
Power supply/output lead wire	ZS-40-W	Lead wire length 2 m
Sensor connector (e-con)	ZS-28-CA-4	1 pc.
Copy lead wire	ZS-40-Y	Possible to connect up to 10 slaves.

Summary of Product parts

Front

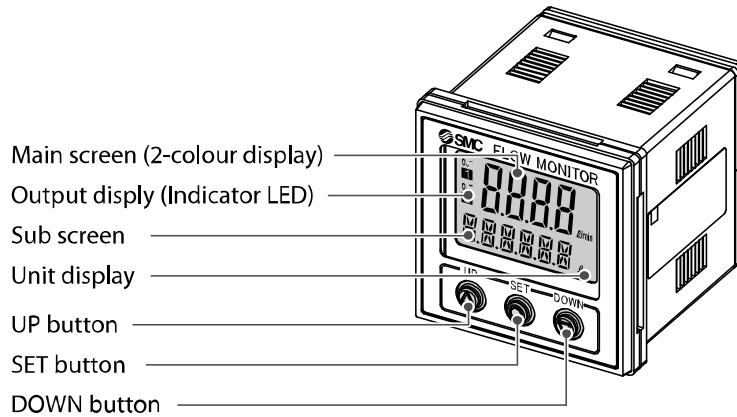

Element	Description
Main screen (2-colour display)	Displays the flow, the status of setting mode and error code.
Sub screen	Displays the accumulated flow, set value, peak/bottom value, fluid temperature and line names.
Output display (Indicator LED)	Displays the output status of OUT1 and OUT2. When ON: Orange LED is ON.
Unit display	Displays the unit selected.
UP button	Selects a mode and the display shown at the sub screen, and increases the ON/OFF set values.
SET button	Press this button to select mode and to confirm a set value.
DOWN button	Selects a mode and the display shown at the sub screen, and decreases the ON/OFF set values.

Back

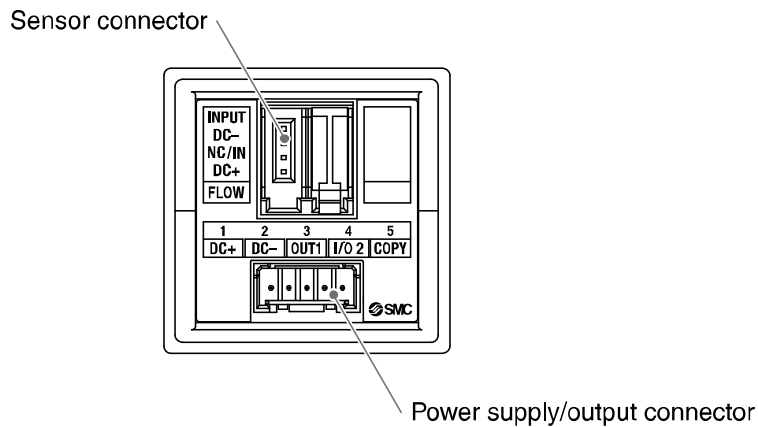

■ Definition and terminology

	Terms	Meaning
A	Accumulated flow	The total amount of fluid that has passed through the device. If an instantaneous flow of 10 L/min continues for 5 minutes, the accumulated flow will be $10 \times 5=50$ L.
	Accumulated flow external reset	A function to reset the accumulated flow to zero by using an external signal.
	Accumulated pulse output	A type of output where a pulse is generated every time a predefined accumulated flow passes. It is possible to calculate the total accumulated flow by counting the pulses.
	Analogue output	Outputs a value proportional to the flow rate. When the analogue output is in the range 1 to 5 V, it will vary between 1 to 5 V according to the rate of flow. The same for analogue output of 4 to 20 mA.
C	Chattering	The problem of the switch output turning ON and OFF repeatedly around the set value at high frequency due to the effect of pulsation.
	Copy function	A function to copy flow rate setting values and function settings (excluding fine adjustment of indication value).
D	Display flow range	The range of measured values that can be displayed for a product with a digital display.
F	Fluid temperature	Range of fluid temperature that can be measured by the product.
	F.S. (Full span, Full scale)	Stands for "full span" or "full scale", and indicates varied display value and analogue output range at rated value. For example, when analogue output is 1 to 5 V, F.S. = $5[V] - 1[V] = 4[V]$, (ref. $1\%F.S. = 4[V] \times 1\% = 0.04[V]$)
H	Holding of accumulated flow	A function to store the accumulated flow value in the product's internal memory. The flow value will be stored at a set time interval of either 2 or 5 minutes. When the power supply is turned on, the stored accumulated flow value will be displayed and accumulated flow will continue from that point.
	Hysteresis	The difference between ON and OFF points used to prevent chattering. Hysteresis can be effective in avoiding the effects of pulsation.
	Hysteresis mode	Mode where the switch output will turn ON when the flow is greater than the set value, and will turn off when the flow falls below (set value – hysteresis value).
I	Instantaneous flow	The flow passing per unit of time. If it is 10 L/min, there is a flow of 10 L passing through the device in 1 minute.
	Internal voltage drop	The voltage drop across the product (and therefore not applied to the load), when the switch output is ON. The voltage drop will vary with load current, and ideally should be 0 V.
K	Key-lock function	This function prevents the set value from being changed by mishandling.
M	Min. setting unit	The resolution of set and display values. If the minimum setting unit is 1 L/min, the display will change in 1 L/min steps, e.g. 10.....11.....12 L/min.
O	Operating temp. range	Ambient temperature range in which product is operable.
P	Power saving mode	The condition in which the digital display turns off and the current consumption is reduced.
R	Repeatability	Reproducibility of the display or analogue output value, when the measured quantity is repeatedly increased and decreased.
	Response time	Time from when the target flow is applied until the flow reaches 90% of the set value.

	Terms	Meaning
S	Set flow range	The range of ON/OFF threshold values that can be set for those products with a switch output.
	Switch output	Output type that has only 2 conditions, ON or OFF. When in the ON condition an indicator light will show, and any connected load will be powered. When in the OFF condition, there will be no indicator light and no power supplied to the load.
T	Temperature characteristics	Indicates the change in the display value and analogue output caused by ambient temperature changes.
U	Unit selection function	A function to select display units other than the international unit (SI unit) specified in the new Japanese measurement law. Flow can only be displayed by SI units in Japan.
W	Water hammer	A momentary steep pressure increase due the spread of pressure by closing a contactor such as a valve for an extremely short time while there is a flow. This pressure increase is known as water hammer or impact pressure.
	Window comparator mode	An operating mode in which the switch output is turned on and off depending on whether the flow is inside or outside the range of two set values.

Mounting and Installation

■ Installation

Mounting with panel mount adapter

Fix the panel mount adapter to the flow monitor with the screws supplied M3 x 8 L (2 pcs.).

Panel mount adapter (Part number: ZS-26-B)

Front protective cover (Part number: ZS-26-01)

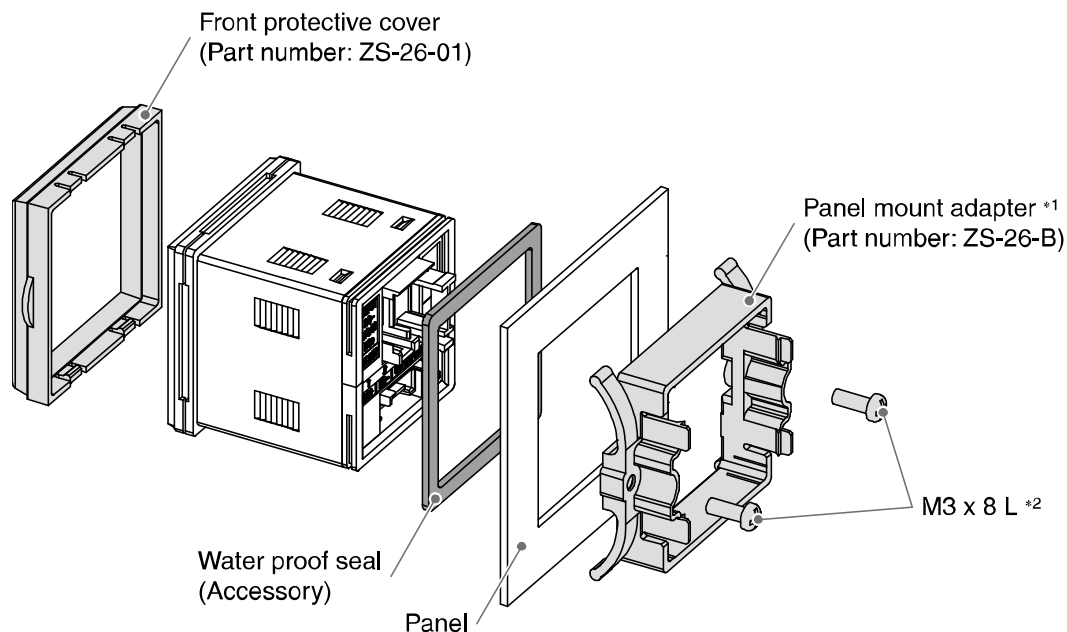

*1: The panel mount adapter can be rotated through 90 degrees for mounting.

*2: The panel mount adapter should be fixed firmly with screws. Otherwise, fluids such as water may enter. After contact with the panel, tighten screws by 1/4 to 1/2 turn.

Cut-out dimensions for panel mounting

*: Refer to page 72 for panel cut-out dimensions.

Notice when removing the product

The product with panel mount adapter can be removed from the panel after removing the two screws, and by disconnecting the hooks on both sides.

This can be done by inserting a suitable piece of thin card (as shown in the figure).

Pull the panel mount adapter to the front, and remove the flow monitor.

If the panel mount adapter is pulled forward with the hook caught, the product and the adapter may be damaged.

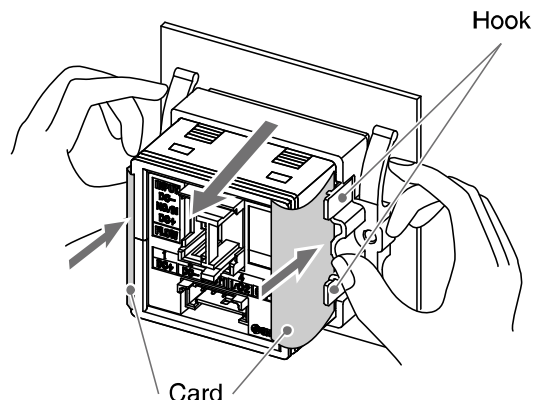

■Wiring

Connecting and disconnecting of the sensor connector and power supply/output connector

- When connecting, insert the connectors straight into the body until it clicks.
- To remove the connectors, push the lever downward with your thumb, and pull the connectors out straight.

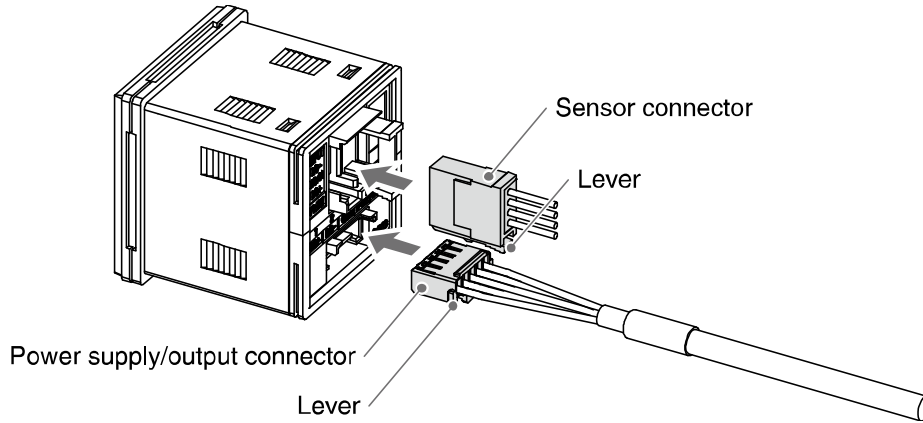

Sensor connector

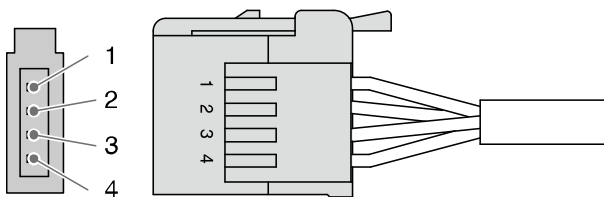

Pin No.	Description	Wire colour
1	DC(+)	Brown
2	N.C. / temp. analogue input (1 to 5 V)	White
3	DC(-)	Blue
4	flow analogue input (1 to 5 V)	Black

Power supply/output connector

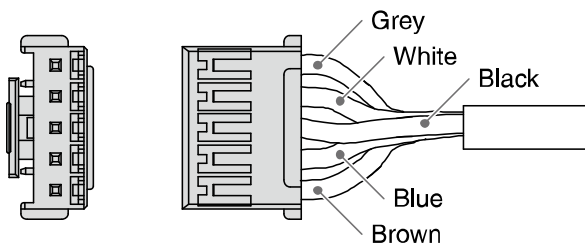

Description	Wire colour
COPY	Grey
OUT2	White
OUT1	Black
DC(-)	Blue
DC(+)	Brown

Connector connection

Connections should only be made with the power supply turned off.

Use separate routes for the Flow monitor wiring and any power or high voltage wiring. Otherwise, malfunction may result due to noise.

Ensure that the FG terminal is connected to ground when using a commercially available switch-mode power supply. When a switch-mode power supply is connected to the product, switching noise will be superimposed and the product specification can no longer be met. This can be prevented by inserting a noise filter, such as a line noise filter and ferrite core, between the switch-mode power supply and the product, or by using a series power supply instead of a switch-mode power supply.

Connection of the sensor lead wire and connector

- Strip the sensor lead wire as shown in the figure on the right.
(Refer to the following table for the connector and applicable wire size)

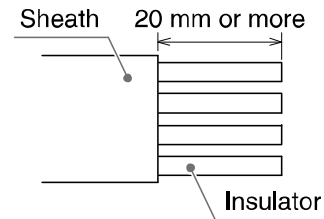

Lead wire table

SMC product No. (1 pc.)	Colour of cover	Insulator outside diameter
ZS-28-CA-4 (option)	Blue	$\phi 1.15$ to $\phi 1.35$
ZS-28-C-1	Yellow	$\phi 1.0$ to $\phi 1.2$

*: The standard value of the insulation outside diameter of AWG No.23 is $\phi 1.14$, but ZS-28-CA-4 is recommended as an applicable connector, taking outside diameter error into consideration.

- Do not cut the insulator.
- The core of the corresponding colour shown in the table below is put into the pin of the number stamped on the connector for sensor connection to the back.

Pin No.	Wire colour *
1	Brown
2	White
3	Blue
4	Black

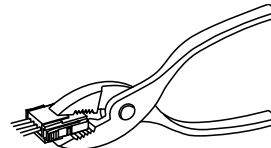
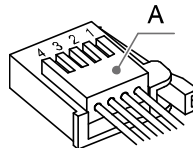

*: When using the lead wire with M8 connector included with the PF3W5 series.

- It checks that the above-mentioned preparation work has been performed correctly, and "A" part shown in the left figure is pushed by hand and makes temporary connection.
- "A" part's center is straightly pushed in by tools, such as pliers.
- Connector for sensor connection is cannot be reused once crimped for connection.
- For the connection failure such as incorrect order of wire and incomplete insertion, please use the new connector for sensor connection.
- When the sensor is not connected correctly, "LLL" can be displayed.

Examples of Internal Circuit and Wiring

NPN2 output type
PF3W30A

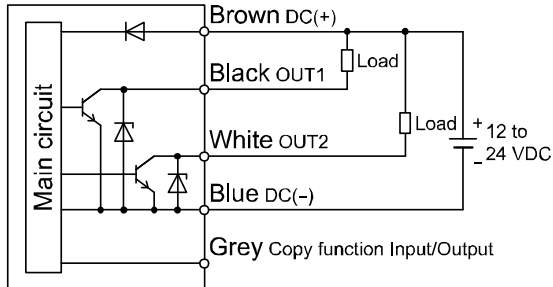

Maximum 28 V, 80 mA
Internal voltage drop 1 V or less

PNP2 output type
PF3W30B

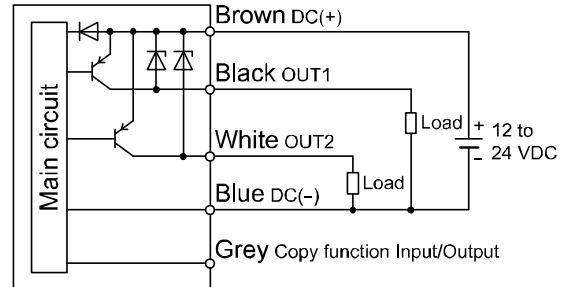

Maximum 80 mA
Internal voltage drop 1.5 V or less

NPN + Analogue output type
PF3W30C
NPN + Analogue output type
PF3W30D

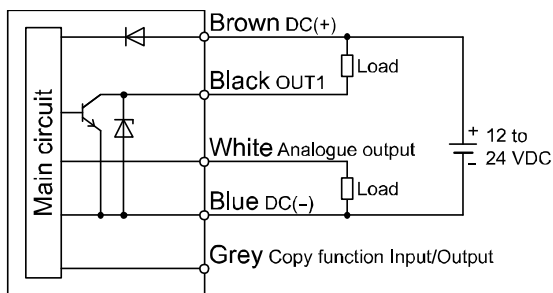

Maximum 28 V, 80 mA
Internal voltage drop 1 V or less
C: Analogue output 1 to 5 V
Output impedance 1 k Ω
D: Analogue output 4 to 20 mA
Maximum load impedance
When power supply is 12 V: 300 Ω
When power supply is 24 V: 600 Ω

PNP + Analogue output type
PF3W30E
PNP + Analogue output type
PF3W30F

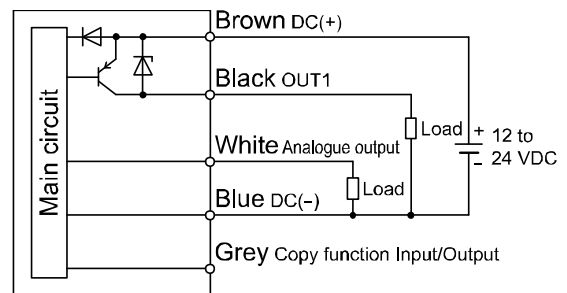

Maximum 80 mA
Internal voltage drop 1.5 V or less
E: Analogue output 1 to 5 V
Output impedance 1 k Ω
F: Analogue output 4 to 20 mA
Maximum load impedance
When power supply is 12 V: 300 Ω
When power supply is 24 V: 600 Ω

NPN + External input type
PF3W30G

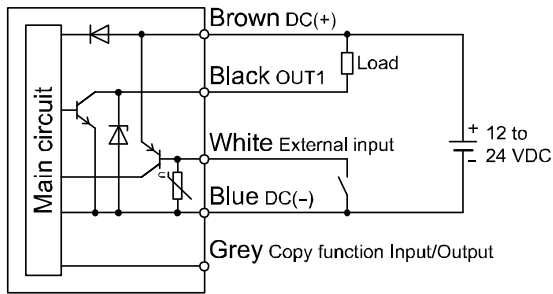

Maximum 28 V, 80 mA
Internal voltage drop 1 V or less
External input: Voltage free contact
Reed or solid state input 30 ms
minimum duration

PNP+ External input type
PF3W30H

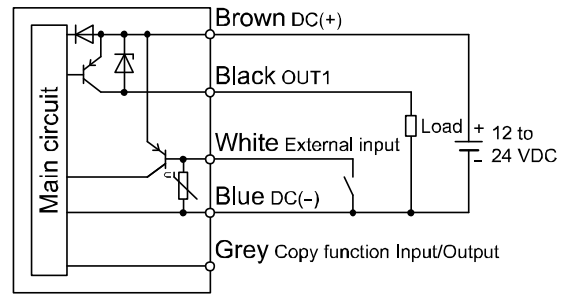

Maximum 80 mA
Internal voltage drop 1.5 V or less
External input: Voltage free contact
Reed or solid state input 30 ms
minimum duration

Analogue 2 output type
PF3W30J/PF3W30K

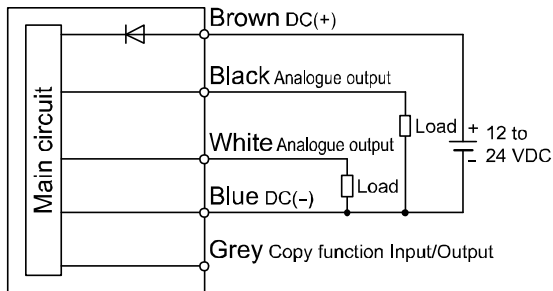

J: Analogue output 1 to 5 V
Output impedance 1 k Ω
K: Analogue output 4 to 20 mA
Maximum load impedance
When power supply is 12 V: 300 Ω
When power supply is 24 V: 600 Ω

Example of wiring for accumulated pulse output

NPN 2output type

PF3W30A

NPN + Analogue output type

PF3W30C/PF3W30D

NPN + External input type

PF3W30G

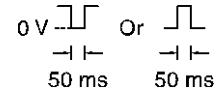
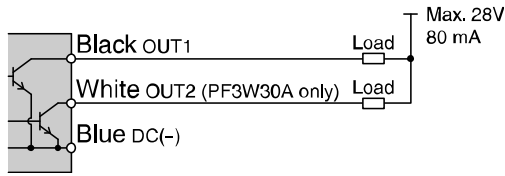

PNP 2 output type

PF3W30B

PNP + Analogue output type

PF3W30E/PF3W30F

PNP + External input type

PF3W30H

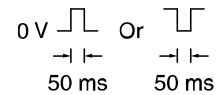
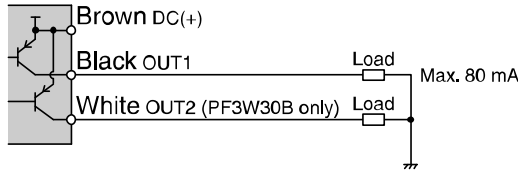

When accumulated pulse output is selected, the indicator light is turned off.

With the temperature sensor

The temperature sensor output is available at OUT2 only.

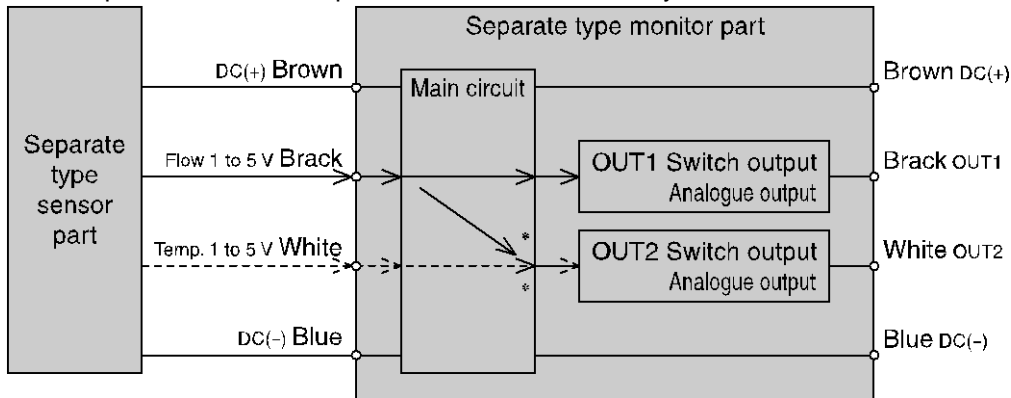

*: The output at OUT2 can be selected between temperature and flow by setting.

Flow Setting

Measurement mode

The mode in which the flow is detected and displayed, and the switch function is operating. This is the basic operating mode; other modes should be selected for set-point and other function setting changes.

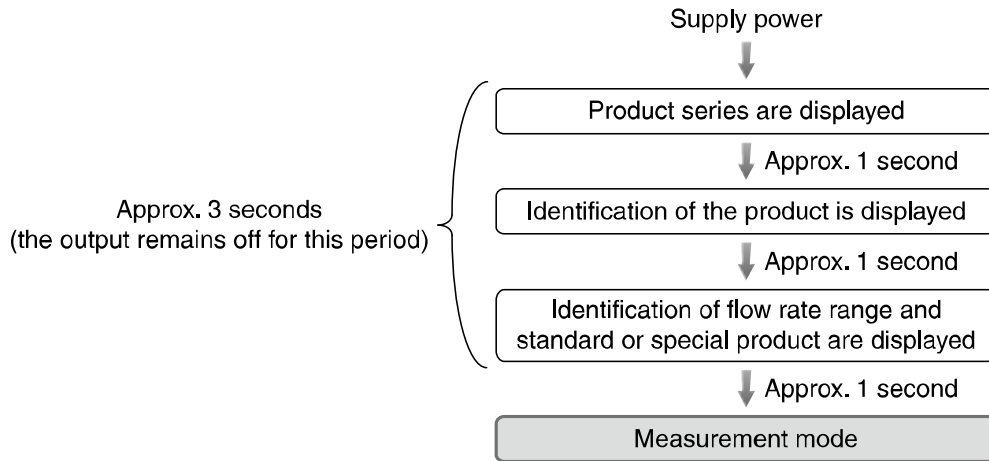

- *: The outputs will continue to operate during setting.
- *: If a button operation is not performed for 30 seconds during the setting, the display will flash (This is to prevent the setting from remaining incomplete if, for instance, an operator were to leave during setting).
- *: 3 step setting mode and Function selecting mode are reflected on each other.

Display of sub screen

In measurement mode, the display of the sub screen can be temporarily changed by pressing the Δ or ∇ buttons.

After 30 seconds, it will automatically reset to the display selected in [F10]. (Refer to page 42.)
(Example shown is for 4 L/min type)

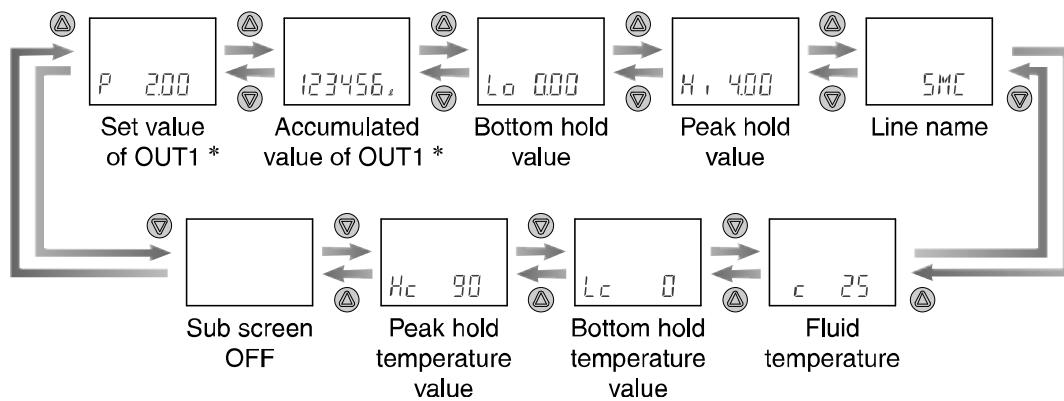

- *: The set values and accumulated output of OUT2 cannot be displayed.

Default settings

When the flow exceeds the set value, the switch will be turned ON.

When the flow falls below the set value by the amount of hysteresis or more, the switch will be turned OFF.

If the operation shown the below is acceptable, please keep this setting.

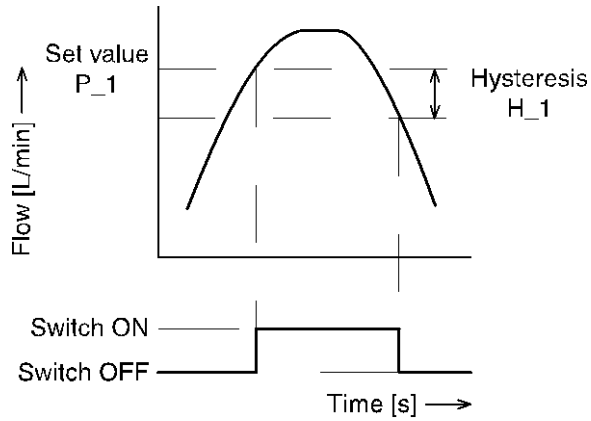

Refer to the following pages for how to change the settings.

*: For input of hysteresis, perform the settings referring to [F 1] Setting of OUT1 (page 27 to) and [F 2] Setting of OUT2 (page 35 to).

<Operation of the set value change > (3 step setting mode)

*: Be sure to select the correct sensor to be connected. (Refer to page 26.)

1. Press the  button in measurement mode to display set values.

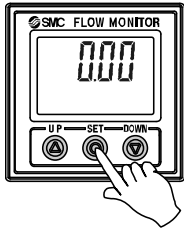

2. [P_1] or [n_1] and the set value are displayed alternately.

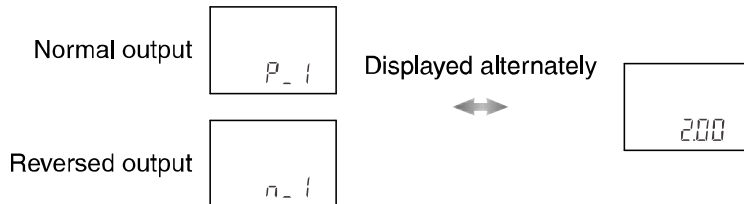

3. Press the  or  button to change the set value.

The  button is to increase and the  button is to decrease the set value.

• Press the  button once to increase by one digit, or press and hold to continuously increase.

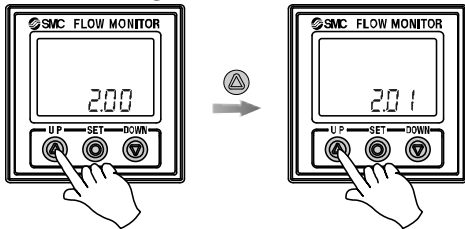

• Press the  button once to decrease by one digit, or press and hold to continuously decrease.

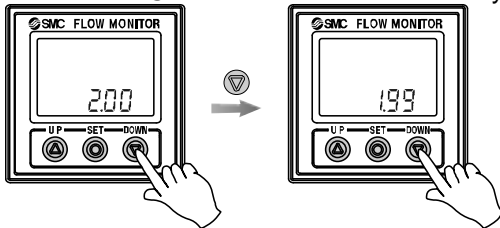

4. Press the  button to finish the setting.

*: For models with switch outputs for both OUT1 and OUT2, [tn] or [tp] will be displayed too. Set as above.

*: For models with the temperature sensor attached, [P_2] or [n_2] will be displayed too. Set as above.

*: For input of hysteresis, perform the settings referring to [F 1] Setting of OUT1 (page 27) and [F 2] Setting of OUT2 (page 35).

*: When a mode other than hysteresis mode is selected, "Set value" of page 29 is displayed.

*: Note that the set value and hysteresis are limited by each other.

*: For more detailed settings, set each function in function selection mode (page 24).

Function Setting



Function selection mode

In measurement mode, when the  button is pressed for 2 seconds or longer, [F 0] is displayed.

This [F□□] indicates the mode for changing each functional setting.

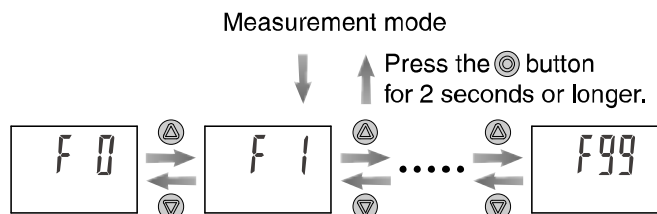
Press the  button for 2 seconds or longer to return to measurement mode.



The function number is increased and decreased by the  and  buttons. Display the required function number and press the  button.

*: The sub screen displays the content of function and the setting of the function alternately.

■ Default settings

Item		Default setting	Page
[F 0]/[RANGE]	[rAn] Selection of sensor	[4] 4 L type	Page 26
[F 1]/[oUt1]	[oU1] Output mode (OUT1)	[HYS] Hysteresis mode	Page 28
	[1ot] Switch operation (OUT1)	[1_P] Normal output	Page 28
	[P_1] Set value (OUT1)	50% of maximum rated flow [2,00] 2.00 L/min (4 L type) [8,0] 8.0 L/min (16 L type) [20,0] 20.0 L/min (40 L type) [50] 50 L/min (100 L type) [126] 126 L/min (250 L type)	Page 29
	[H_1] Hysteresis (OUT1)	5% of maximum rated flow [0,20] 0.20 L/min (4 L type) [0,8] 0.8 L/min (16 L type) [2,0] 2.0 L/min (40 L type) [5] 5 L/min (100 L type) [12] 12 L/min (250 L type)	
	[CoL] Display colour (OUT1)	[SoG] ON: Green, OFF: Red	Page 32
[F 2]/[oUt2]	[oU2] Output mode (OUT2)	[HYS] Hysteresis mode (Flow)	Page 36
	[2ot] Switch operation (OUT2)	[2_P] Normal output	Page 36
	[P_2] Set value (OUT2)	50% of maximum rated flow [2,00] 2.00 L/min (4 L type) [8,0] 8.0 L/min (16 L type) [20,0] 20.0 L/min (40 L type) [50] 50 L/min (100 L type) [126] 126 L/min (250 L type)	Page 37
	[H_2] Hysteresis (OUT2)	5% of maximum rated flow [0,20] 0.20 L/min (4 L type) [0,8] 0.8 L/min (16 L type) [2,0] 2.0 L/min (40 L type) [5] 5 L/min (100 L type) [12] 12 L/min (250 L type)	
	[F 3]/[RES]	[rES] Response time setting	[1,00] 1 second
[F10]/[SUB]	[SUB] Selection of sub screen	[oUt] Display of set value (OUT1)	Page 42
[F20]/[iNP]	[inP] Setting of external input	[REACUM] Accumulated flow external reset	Page 46
[F22]/[AnA]	[AnA] Setting of analogue output	[FLoW] Analogue output of flow	Page 47
	[FrE] Free range	[oFF] Free range: OFF	
[F30]/[SAVE]	[SAVE] Storing of accumulated flow	[oFF] OFF [not held]	Page 49
[F80]/[dSP]	[dSP] Setting of power saving mode	[oN] No setting [display is turned on]	Page 50
[F81]/[PiN]	[Pin] Setting of security code	[oFF] OFF	Page 51
[F82]/[LiNE]	[LinE] Input of line name	[* * * * *] No name *****	Page 52
[F90]/[ALL]	[ALL] Setting of all functions	[oFF] OFF	Page 53
[F96]/[SEN iN]	[1_iN] Input check (INPUT1)	[]	Page 54
	[2_iN] Input check (INPUT2)	[]	
[F97]/[CoPY]	[CoPY] Copy function	[oFF] OFF	Page 55
[F98]/[tESt]	[tESt] Output check	[NoRMAL] OFF	Page 58
[F99]/[iNi]	[ini] Reset to the default settings	[oFF] OFF	Page 59

■[F 0] Selection of sensor

Be sure to select the correct sensor to be connected before use.

In measurement mode, when the  button is pressed for 2 seconds or longer, [F 0] is displayed.



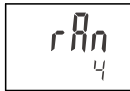

The sub screen displays [RANGE] and the currently selected flow rate alternately.

↓ Press the  button.

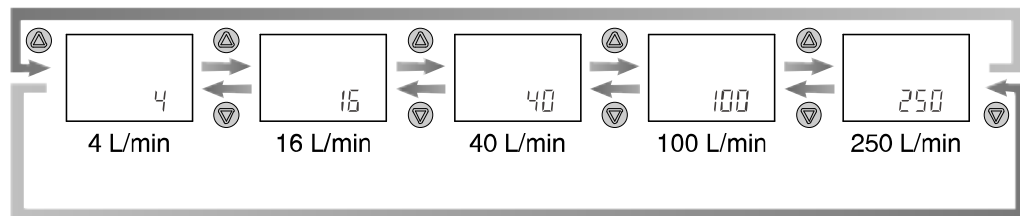

Sub screen



Press the  or  button to select the sensor to be connected.

Press the  button to confirm. ↓ Return to the function selection mode.

[F 0] Sensor selection is completed.

■[F 1] Setting of OUT1

The output mode of OUT1 can be selected.

<Flowchart of functions>

1. Selection of output mode

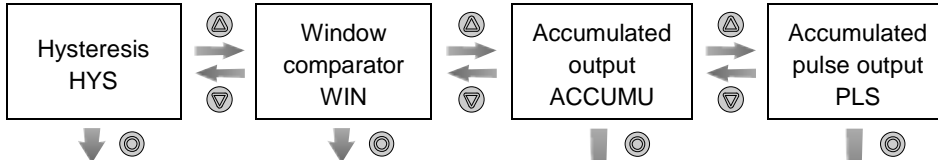

2. Setting of switch operation

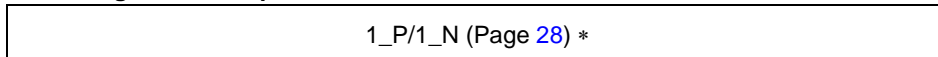

(Display type)

Setting of
Add/dEC
(Page 30)

3. Input of set values

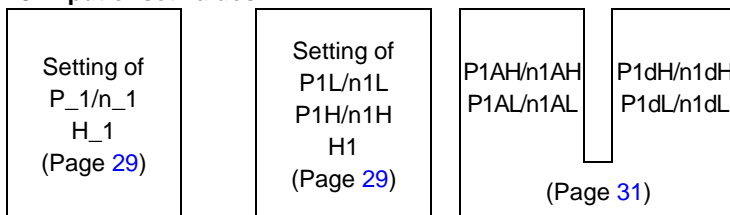

4. Selection of display colour

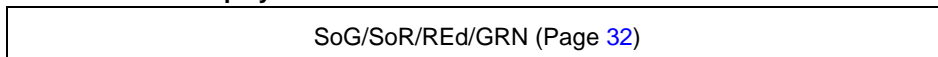

5. Completed

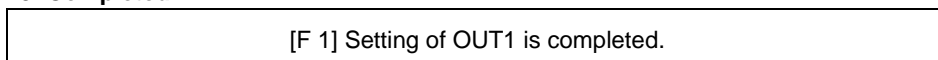

<Operation>

1. Selection of output mode

Press the or button in function selection mode to display [F 1] on the main screen.

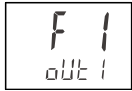

The sub screen displays [oUt1] and the currently set output mode alternately.

↓ Press the button.



Sub screen

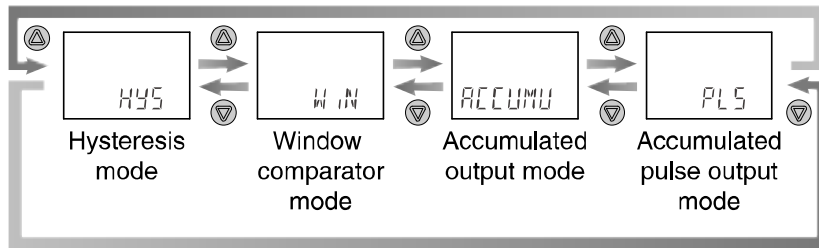

Press the or button to select the output mode.

*: When the accumulated pulse output is selected, the output display will turn off.

Press the button to confirm. ↓ Move on to the setting of switch operation.

2. Setting of switch operation



Sub screen

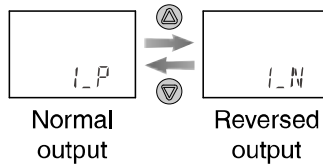

Press the or button to select the switch operation.

*: By switching the output, the display colour will change in relation to the setting.

Press the button to confirm. ↓ Move on to the input of set values.
(ON and OFF points)

3. Input of set values

a. When hysteresis output mode is selected.

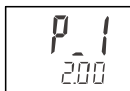

The sub screen displays the set value. Change it with the ▲ and ▼ buttons.
(When reversed output is selected, the main screen displays [n_1].)

Press the ● button to confirm. ↓ Move on to the setting of hysteresis.



The sub screen displays the hysteresis value. Change it with the ▲ and ▼ buttons.

Press the ● button to confirm. ↓ Move on to the selection of display colour.
(Refer to page 32.)

*: The set value and hysteresis limit each other.

b. When window comparator output mode is selected.

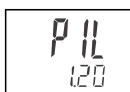

The sub screen displays the set value. Change it with the ▲ and ▼ buttons.
(When reversed output is selected, the main screen displays [n1L].)

Press the ● button to confirm. ↓ Move on to the input of set values for [P1H] (or [n1H]).

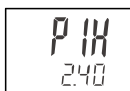

The sub screen displays the set value. Change it with the ▲ and ▼ buttons.
(When reversed output is selected, the main screen displays [n1H].)

Press the ● button to confirm. ↓ Move on to the setting of hysteresis.



The sub screen displays the hysteresis value. Change it with the ▲ and ▼ buttons.

Press the ● button to confirm. ↓ Move on to the selection of display colour.
(Refer to page 32.)

c. When accumulated output mode is selected.

Selection of accumulated increment or decrement

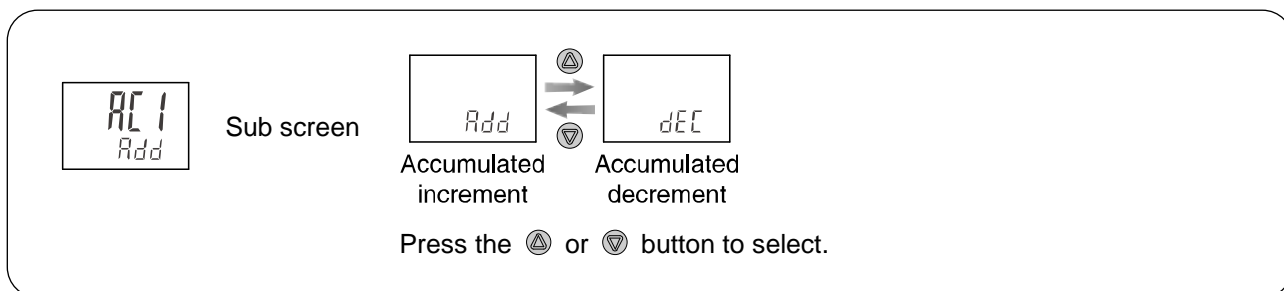

Press the  button to confirm.  Move on to the input of set values.

When accumulated increment is selected.

When accumulated decrement is selected.



(When the reversed output is selected, the main screen displays [n1AH].)



(When the reversed output is selected, the main screen displays [n1dH].)

Setting of the first 3 digits



When the button is pressed for 1 second or longer, the flashing will stop.

Press the button again.

Setting of the latter 6 digits

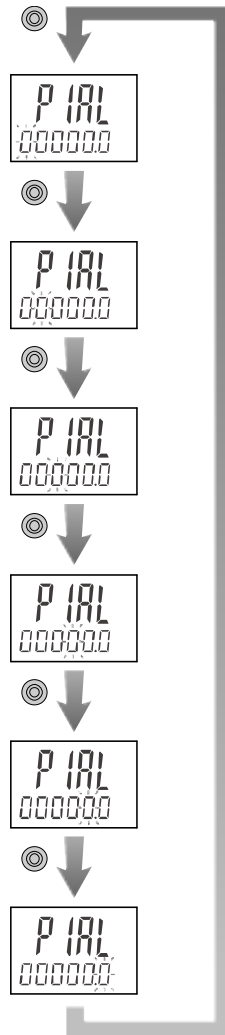

When the button is pressed for 1 second or longer, the flashing will stop.

The sub screen displays the value, and the leftmost digit of the set value will start flashing.

(The required accumulated value should be input one digit at a time.)

Press the and buttons to change the value.

Press the button to move onto the input to the next right digit.

Pressing the button again will select the next digit to the right.

After the input of the first 3 digits is complete, press the button for 1 second or longer. The flashing will stop.

Press the button again to confirm the values of the first 3 digits and move onto the input of the next 6 digits.

After the input to the next 6 digits is complete, press the button for 1 second or longer to confirm.

Press the button to confirm. Move on to the selection of display colour.

4. Selection of display colour

Display colour can be set to change depending upon the status of OUT1.

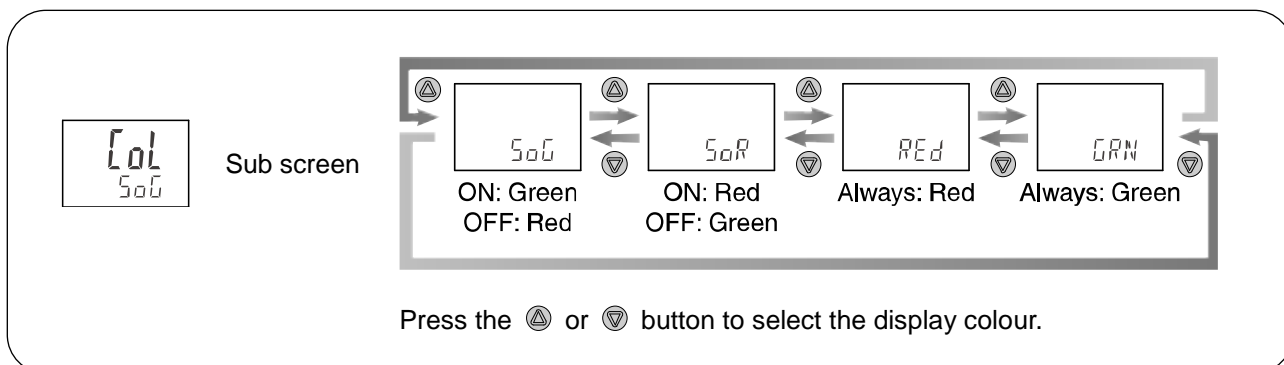

Press the button to confirm. Return to the function selection mode.

5. Completed

[F 1] Setting of OUT1 is completed.

oList of output modes

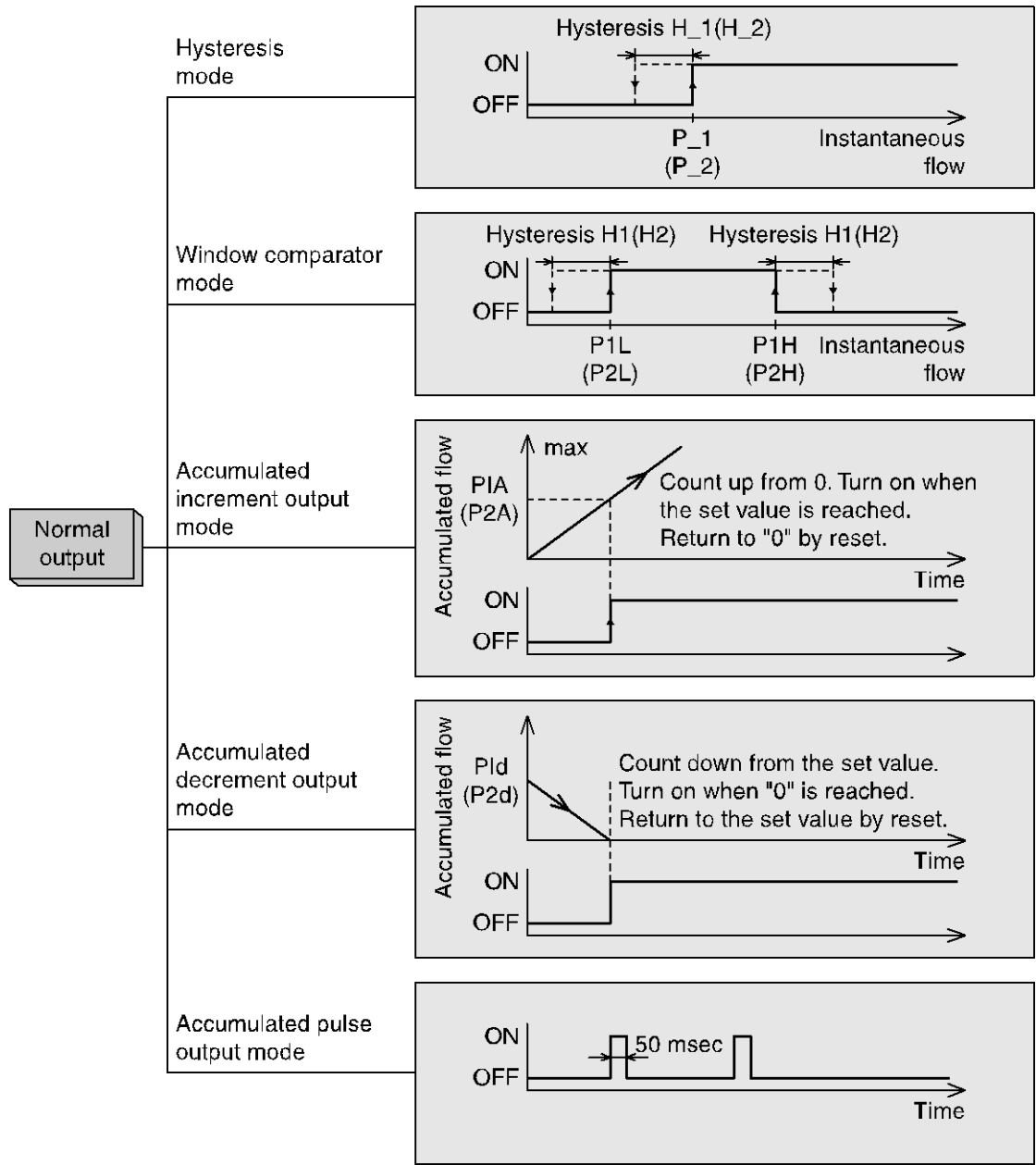

*: If hysteresis or window comparator mode is selected and there is an unstable flow condition (due to fluid pulsation, for example), unstable output operation can result.

In such situations, keep sufficient margin between the set values and confirm that the output operation stabilizes.

*: When the accumulated pulse output is selected, the output display will turn off.

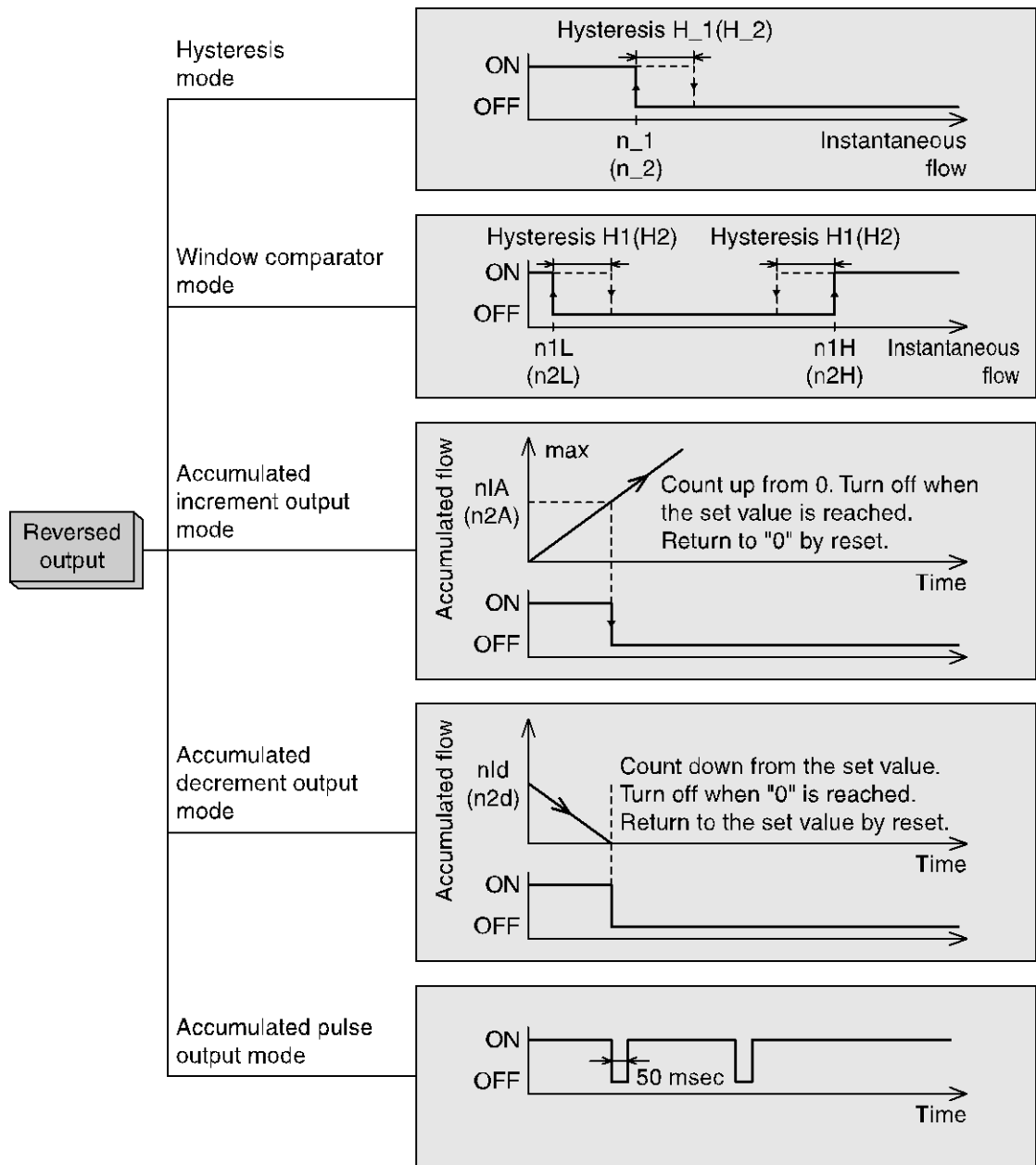

*: If hysteresis or window comparator mode is selected and there is an unstable flow condition (due to fluid pulsation, for example), unstable output operation can result.

In such situations, keep sufficient margin between the set values and confirm that the output operation stabilizes.

*: When the accumulated pulse output is selected, the output display will turn off.

■[F 2] Setting of OUT2

The output mode of OUT2 can be selected.

The display colour is defined by OUT1 and cannot be changed with any OUT2 settings.

<Flowchart of functions>

1. Selection of output mode

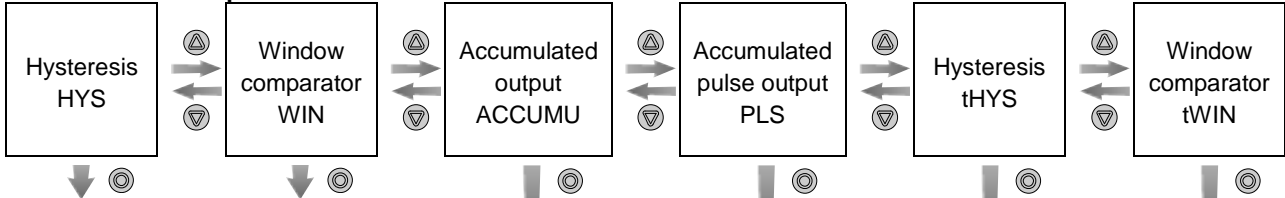

2. Setting of switch operation

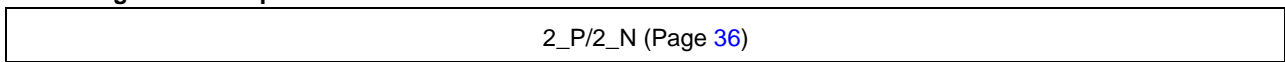

3. Input of set values

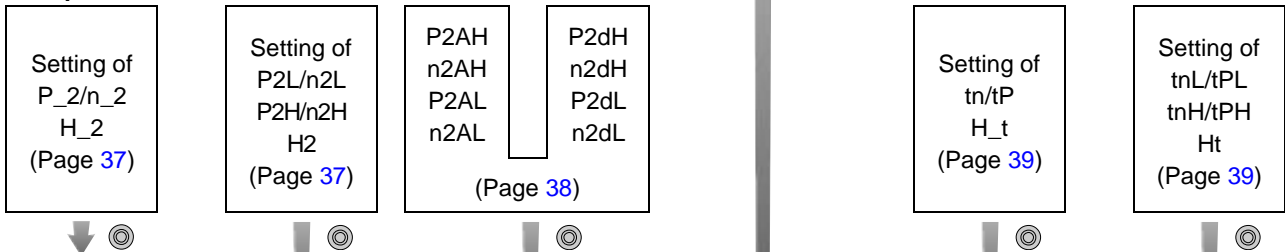

4. Completed

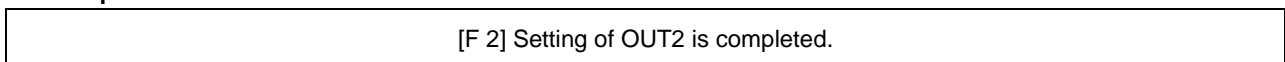

<Operation>

1. Selection of output mode

Press the or button in function selection mode to display [F 2] on the main screen.



The sub screen displays [oUt2] and the currently set output mode alternately.
*: If OUT2 is not provided, the display will be [---].

↓ Press the button.



Sub screen

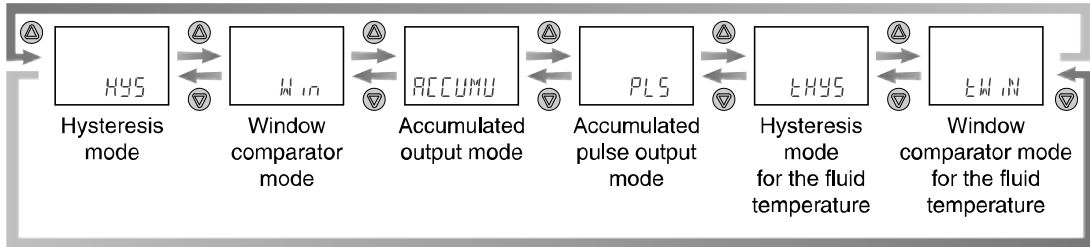

Press the or button to select the output mode.

Press the button to confirm. ↓ Move on to the setting of switch operation.

2. Setting of switch operation



Sub screen

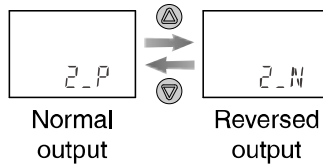

Press the or button to select switch operation.

Press the button to confirm. ↓ Move on to the input of set values.
(ON and OFF points)

3. Input of set values

a. When hysteresis output mode is selected.



The sub screen displays the set value. Change it with the ▲ and ▼ buttons.
(When reversed output is selected, the main screen displays [n_2].)

Press the ● button to confirm. ↓ Move on to the setting of hysteresis.



The sub screen displays the hysteresis value. Change it with the ▲ and ▼ buttons.

Press the ● button to confirm. ↓ Return to the function selection mode.

4. Completed

[F 2] Setting of OUT2 is completed.

*: The set value and hysteresis limit each other.

b. When window comparator output mode is selected.

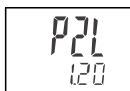

The sub screen displays the set value. Change it with the ▲ and ▼ buttons.
(When reversed output is selected, the main screen displays [n2L].)

Press the ● button to confirm. ↓ Move on to the input of set values for [P2H] (or [n2H]).



The sub screen displays the set value. Change it with the ▲ and ▼ buttons.
(When reversed output is selected, the main screen displays [n2H].)

Press the ● button to confirm. ↓ Move on to the setting of hysteresis.



The sub screen displays the hysteresis value. Change it with the ▲ and ▼ buttons.

Press the ● button to confirm. ↓ Return to the function selection mode.

4. Completed

[F 2] Setting of OUT2 is completed.

c. When accumulated output mode is selected.

The setting of Add/dEC is linked to the setting of OUT1, and can not be selected. (Refer to page 30.)

When accumulated increment is selected at the OUT1 setting.

When accumulated decrement is selected at the OUT1 setting.



(When the reversed output is selected, the main screen displays [n2AH].)



(When the reversed output is selected, the main screen displays [n2dH].)

Setting of the first 3 digits

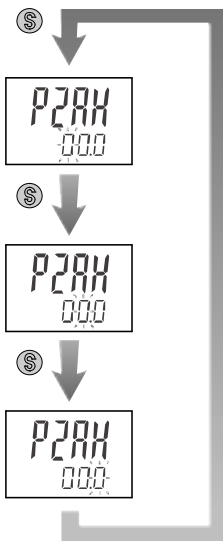

When the **S** button is pressed for 1 second or longer, the flashing will stop.

Setting of the latter 6 digits

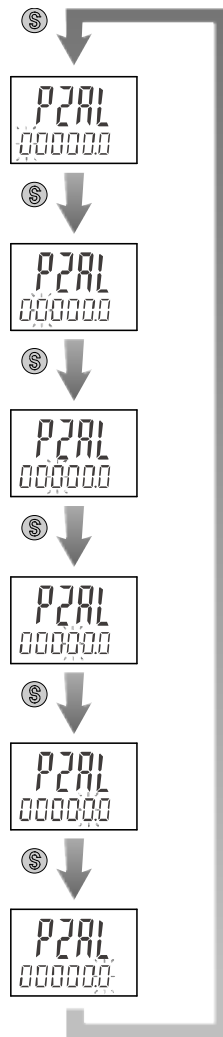

When the **S** button is pressed for 1 second or longer, the flashing will stop.

Press the **S** button again.

The sub screen displays the value, and the leftmost digit of the set value will start flashing.

(The required accumulated value should be input one digit at a time.)

Press the **▲** and **▼** buttons to change the value.

Press the **S** button to move onto the input to the next right digit.

Pressing the **S** button again will select the next digit to the right.

After the input of the first 3 digits is complete, press the **S** button for 1 second or longer. The flashing will stop.

Press the **S** button again to confirm the values of the first 3 digits and move onto the input of the next 6 digits.

After the input to the next 6 digits is complete, press the **S** button for 1 second or longer to confirm.

Press the **S** button to confirm. ↓ Return to the function selection mode.

4. Completed

[F 2] Setting of OUT2 is completed.

d. When hysteresis mode for fluid temperature is selected.

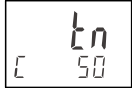

The sub screen displays the set value. Change it with the ▲ and ▼ buttons. (When the normal output is selected, the main screen displays [tP].)

Press the ● button to confirm. ↓ Move on to the setting of hysteresis.

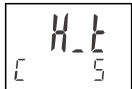

The sub screen displays the set value. Change it with the ▲ and ▼ buttons.

Press the ● button to confirm. ↓ Return to the function selection mode.

4. Completed

[F 2] Setting of OUT2 is completed.

e. When window comparator mode for fluid temperature is selected.

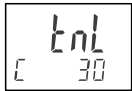

The sub screen displays the set value. Change it with the ▲ and ▼ buttons. (When the normal output is selected, the main screen displays [tPL].)

Press the ● button to confirm. ↓ Move on to the input of set values for [tPH] (or [tnH]).



The sub screen displays the set value. Change it with the ▲ and ▼ buttons. (When the normal output is selected, the main screen displays [tPH].)

Press the ● button to confirm. ↓ Move on to the setting of hysteresis.



The sub screen displays the set value. Change it with the ▲ and ▼ buttons.

Press the ● button to confirm. ↓ Return to the function selection mode.

4. Completed

[F 2] Setting of OUT2 is completed.

*: The left most digit [c] shows Centigrade (°C). The digit [F] shows Fahrenheit (°F). (Fahrenheit is available as made to order.)

oList of output modes for fluid temperature

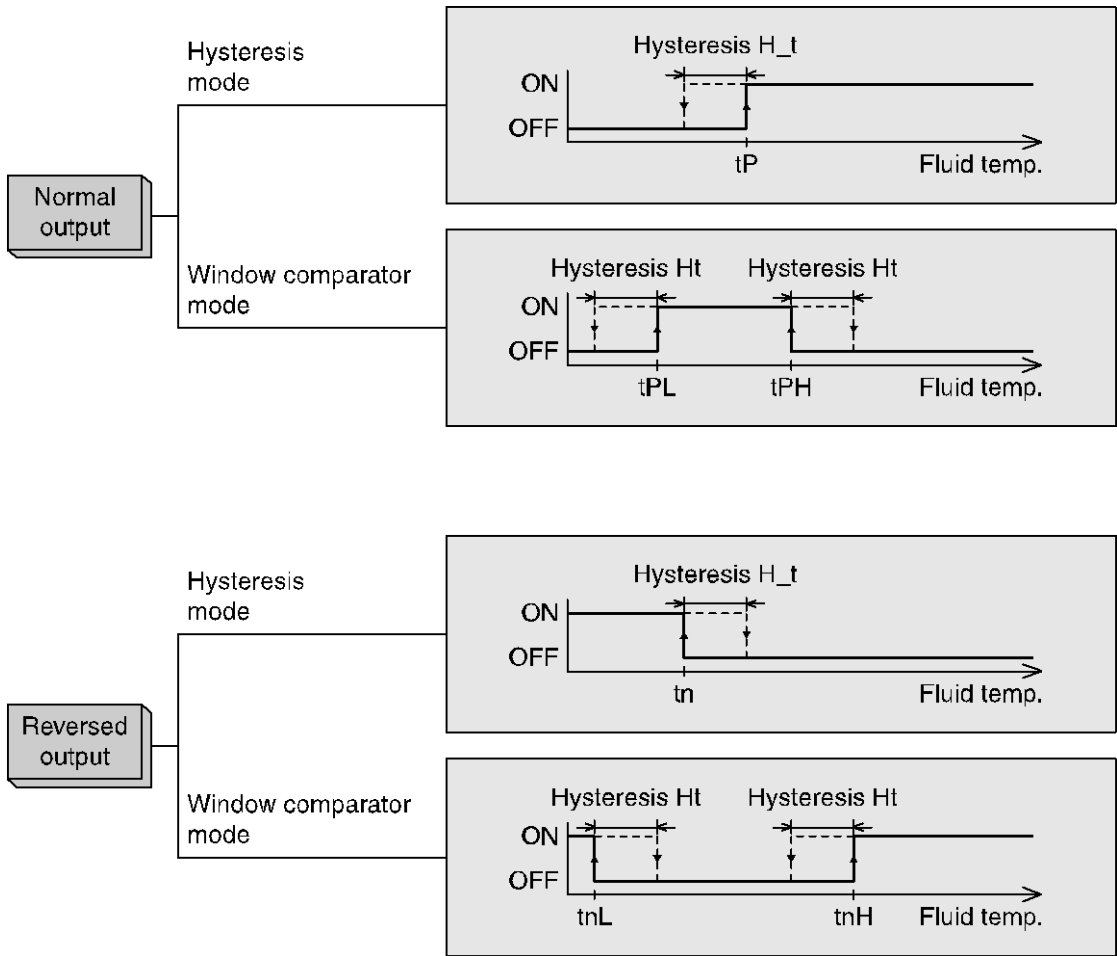



■[F 3] Response time setting

The response time of the switch output can be set.

Appropriate setting of the response time can prevent the switch output from chattering.

<Operation>

Press the  or  button in function selection mode to display [F 3] on the main screen.

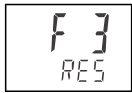



The sub screen displays [RES] and the current set value alternately.

↓ Press the  button.

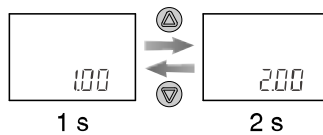

Sub screen



Press the  or  button to select the response time.

Press the  button to confirm. ↓ Return to the function selection mode.

[F 3] Response time setting is completed.



*: The response time of the temperature sensor is set about 7 seconds and no connection with this setting value.

■[F10] Selection of sub screen

The display shown on the sub screen during measurement mode can be set.

- Switch point value display: Displays the set value for switch point of OUT1.
(The set value for the switch point of OUT2 can not be displayed.)
- Accumulated value display: Displays the accumulated value of OUT1.
(The accumulated value of OUT2 can not be displayed.)
- Bottom value display: Displays the minimum measured flow rate value since the last reset.
- Peak value display: Displays the maximum measured flow rate value since the last reset.
- Display of line name: Displays the name of the line.
- Display of fluid temperature: Displays the temperature of fluid.
- Temperature bottom display: The bottom value of fluid temperature displayed.
- Temperature peak display: The peak value of fluid temperature displayed.
- OFF: Displays nothing.

<Operation>

Press the  or  button in function selection mode to display [F10] on the main screen.

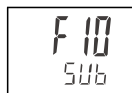

The sub screen displays [SUB] and the current set value alternately.

↓ Press the  button.

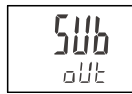

The sub screen displays the current set value.

Sub screen

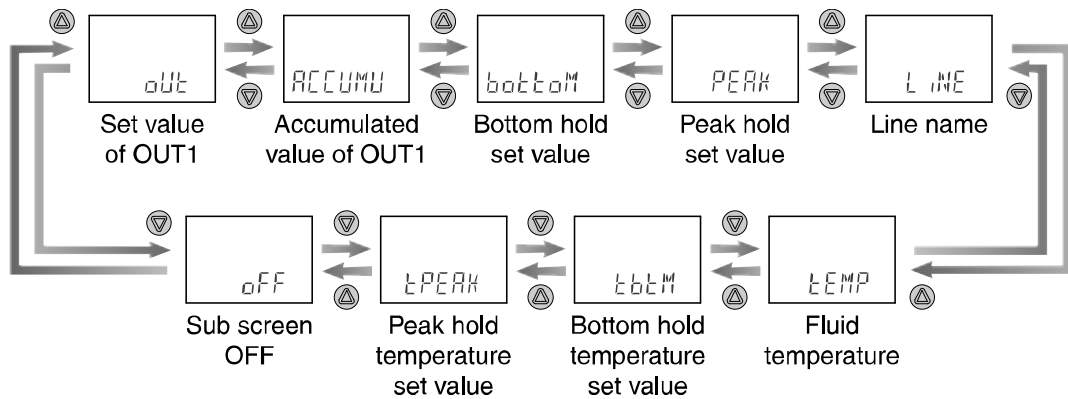

Press the  or  button to select the display.

Press the  button to confirm. ↓ Return to the function selection mode.

[F10] Selection of sub screen is completed.

<Example of display of sub screen>

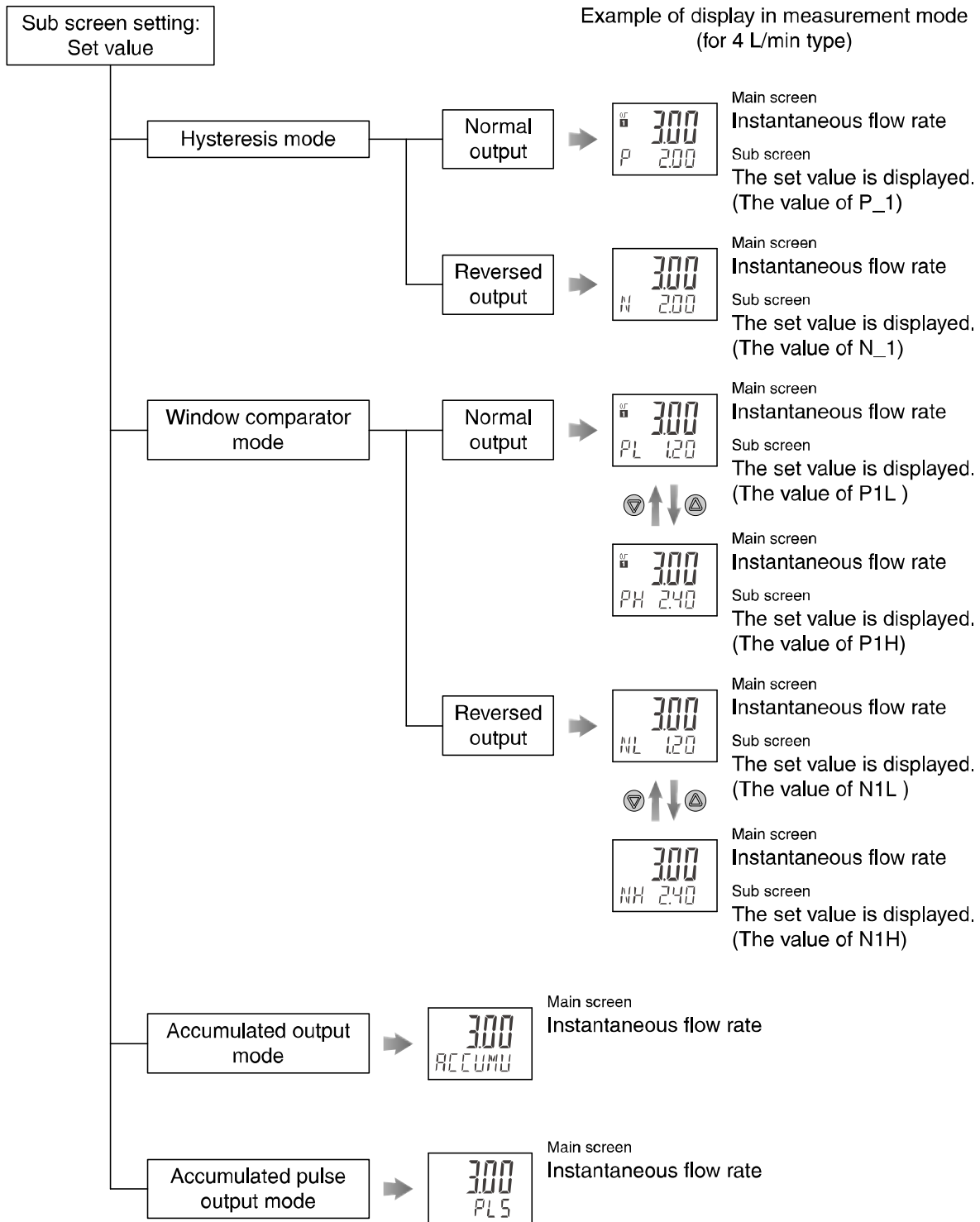

<Example of display of sub screen (continued)>

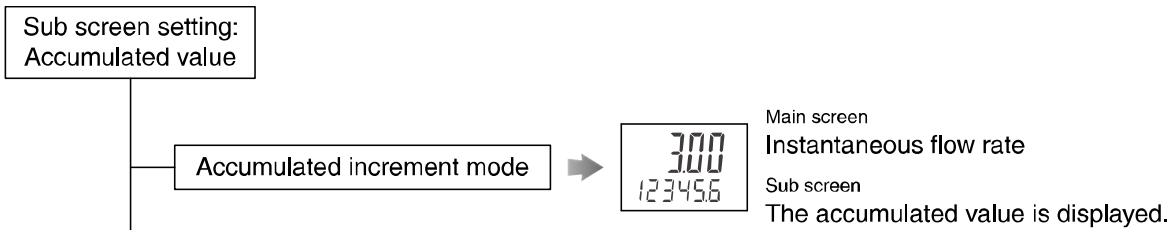

- The accumulated value increases according to the instantaneous flow.
- When the value exceeds 999999 L, the higher 3 digits (1.5 s) and lower 6 digits (3 s) are displayed alternately.
- When 999999999 L is reached, the display stops with [999999999] flashing.
Accumulation will start automatically in measurement mode after the power is supplied.
(When the option to memorize the cumulated value is selected, it will start from the memorized value. (Refer to [F30] Storing of accumulated flow.))
- Pressing the and button for 1 second resets the accumulated value (to 0).
- If the external input is available, the value can also be reset (to 0) by external input.
(Refer to [F20] Setting of external input on page 46.)



- The accumulated value decreases from the set value according to the instantaneous flow.
- When the value exceeds 999999 L, the higher 3 digits (1.5 s) and lower 6 digits (3 s) are displayed alternately.
- Below 999999 L, only the lower 6 digits are displayed.
When the accumulated value decreases to 0, the display stops with [0] flashing.
Accumulation will start automatically in measurement mode after the power is supplied.
(When the option to memorize the cumulated value is selected, it will start from the memorized value. (Refer to [F30] Storing of accumulated flow.))
- Pressing the and buttons for 1 second resets the accumulated value (to the set value).
- If the external input is available, the value can also be reset (to the set value) by external input.
(Refer to [F20] Setting of external input on page 46.)

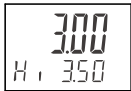

<Example of display of sub screen (continued)>

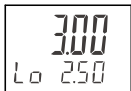
Sub screen setting: Peak hold value →  Main screen
Instantaneous flow rate
Sub screen
The peak hold value is displayed.

Sub screen setting: Bottom hold value →  Main screen
Instantaneous flow rate
Sub screen
The bottom hold value is displayed.

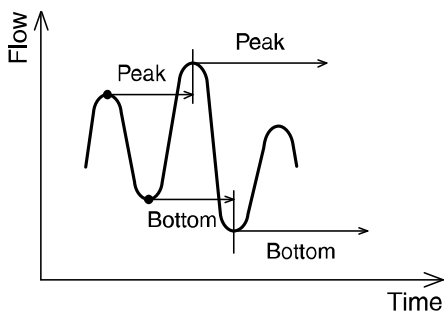
The maximum (peak) and minimum (bottom) flow from when the power is supplied to this moment is detected and updated.



- Pressing the  and  buttons for 1 second clears the peak and bottom values.
- If the external input is available, the values can also be reset by external input. (Refer to [F20] Setting of external input on page 46.)

Sub screen setting: Line name →  Main screen
Instantaneous flow rate
Sub screen
The line name is displayed.

The name of piping line at which the product is installed can be displayed. Refer to [F82] Input of line names on page 52 for how to input the line name.

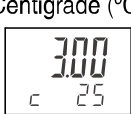
Sub screen setting: Fluid temperature →  Main screen
Instantaneous flow rate
Sub screen
The fluid temperature is displayed.

If a fluid temperature sensor is attached, the fluid temperature can be displayed as well. The left most digit shows Centigrade (°C).

Sub screen setting: OFF →  Main screen
Instantaneous flow rate
Sub screen
OFF

The sub screen can be turned off.

■[F20] Setting of external input

This function can be used only when the optional external input is present. The accumulated value, peak value and bottom value can be reset remotely.

●**Accumulated value external reset:** A function to reset the accumulated value when an input signal is applied.

In accumulated increment mode, the accumulated value will reset to, and increase from zero. In accumulated decrement mode, the accumulated value will reset to, and decrease from the set value.

*: When the accumulated value is memorized and each time the accumulated value external reset is activated, the memory device (EEPROM) will be accessed. The maximum writable limit of the memory device is 1 million cycles and should be considered. The total number of external input resets and accumulated value memorizations should not exceed 1 million.

●**Reset of peak and bottom values:** A function to clear the peak value or bottom value when an input signal is applied.



●**OFF:** The external input function will become invalid.

Input signal: The input line must be connected to GND for a minimum of 30 msec.

●When the input signal is applied, the sub screen will display [ooo] for 1 second.

●If successive input signals are applied at less than 1 second intervals the sub screen display will remain [ooo].

<Operation>

Press the  or  button in function selection mode to display [F20] on the main screen.



The sub screen displays [iNP] and current set value alternately.

*: If the external input is not present, the sub screen alternately displays [iNP] and [- - -].

↓ Press the  button.



Sub screen

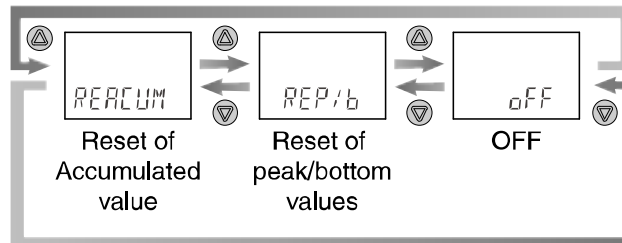

*: If the external input is not available, the sub screen displays [- - -].

Press the  or  button to select the setting of external input.

Press the  button to confirm. ↓ Return to the function selection mode.

[F20] Setting of external input is completed.

■[F22] Setting of analogue output

This function can be used only when the optional analogue output is present.

If the optional temperature sensor is fitted, the analogue output of fluid temperature can be selected.

The flow that generates the output voltage (= 5 V) or output current (= 20 mA) at the span side of analogue output can be variable. (This does not apply if the analogue output to the temperature sensor is selected.)

<Operation>

Press the or button in function selection mode to display [F22] on the main screen.



The sub screen displays [AnA] and the current set value alternately.

*: If the analogue output is not present, the sub screen displays [AnA] and [- - -] alternately.

↓ Press the button.



Sub screen

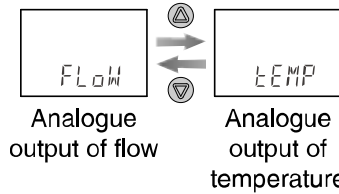

Press the or button to select.

Press the button.
When the "Flow" is selected.

Press the button.
When the "TEMP" is selected.

[F22] Setting of analogue output is completed.



Sub screen

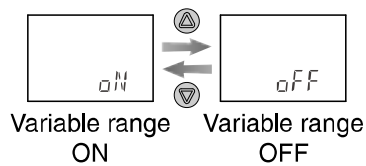

Press the or button to select.

↓ (Continued)

■[F30] Storing of accumulated flow

The default setting is not to store the accumulated flow when the power supply is turned off. This function enables the accumulated flow value to be stored in permanent memory every 2 or 5 minutes. The maximum writable limit of the memory device is 1 million cycles, which should be taken into consideration.

If the product is operated 24 hours per day, the maximum writable limit will be as follows:

Data memorized every 5 minutes --- 5 minutes x 1 million cycles = 5 million minutes = 9.5 years

Data memorized every 2 minutes --- 2 minutes x 1 million cycles = 2 million minutes = 3.8 years

<Operation>

Press the or button in function selection mode to display [F30] on the main screen.



The sub screen displays [SAVE] and the current set value alternately.

↓ Press the button.



Sub screen

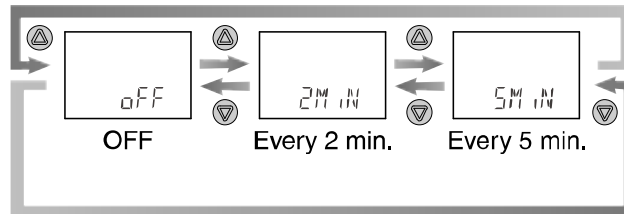

Press the or button to select the setting for storing accumulated flow.

Press the button to confirm. ↓ Return to the function selection mode.

[F30] Setting of accumulated flow storing function is completed.

*: Data memorization is performed every 2 or 5 minutes (depending upon the setting chosen), this means that the accumulated flow value for up to 2 or 5 minutes before the power supply is turned off will not be added to the device memory.

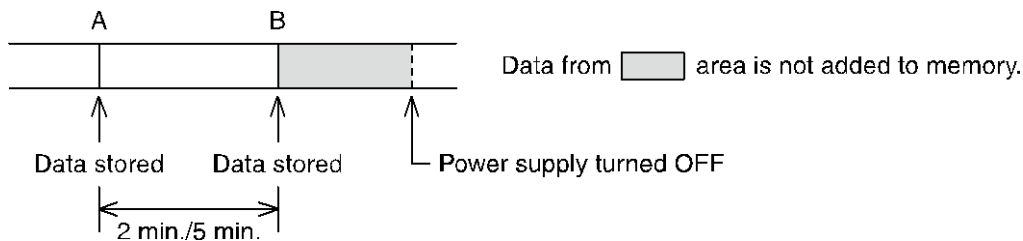

When the power supply is turned on again, the accumulated flow count will start from the value recorded at B.

■[F80] Setting of power saving mode



The display can be turned off to reduce power consumption. (About 12%)

This function is to turn to power saving mode when a button operation is not performed for 30 seconds.

While the display is off, the decimal points of the main screen will flash.

In the default setting, power saving mode is OFF (normal mode).

<Operation>

Press the  or  button in function selection mode to display [F80] on the main screen.



The sub screen displays [dSP] and the current set value alternately.

↓ Press the  button.



Sub screen

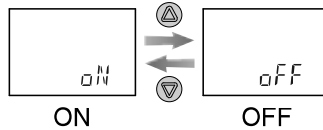

The display can be turned off to save power.

Press the  or  button to select the power saving mode setting.

Press the  button to confirm. ↓ Return to the function selection mode.

[F80] Setting of power saving mode is completed.

In power saving mode, the decimal points on the main screen flash. When any button is operated, the display will turn on. If no button operation is performed for another 30 seconds the display will turn off again.



■[F81] Setting of security code

The security code can be entered while the keys are locked.

For the key-lock function, refer to page 61.

In the default setting, security code entry is not necessary.

<Operation>

Press the  or  button in function selection mode to display [F81] on the main screen.



The sub screen displays [PiN] and the current set value alternately.

↓ Press the  button.

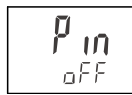

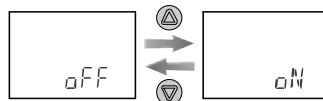

Sub screen



Unused

Use

Press the  or  button to select the setting of security code.



Press the  button to confirm. ↓ Return to the function selection mode.

[F81] Setting of security code is completed.

■[F82] Input of line names

The name of a line can be input. (Up to 6 English characters and/or numbers)
The sub screen setting needs to be changed to show line names.
(Refer to [F10] Selection of display of sub screen on page 42.)

<Operation>

Press the  or  button in function selection mode to display [F82] on the main screen.





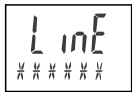

The sub screen displays [LiNE] and the line name alternately.

↓ Press the  button.



Sub screen



The left most digit starts flashing. Select the required character from space→A→b→C•••X→y→Z→0→1•••8→9→_→—→ $\bar{\quad}$ →/→*→space by pressing the  and  buttons.

Press the  button (less than 1 second).
The next digit to the right will flash and can be edited.
(Follow the same procedure for the remaining digits)
After all 6 digits are input, press the  button for 1 second or longer.
Flashing stops.

Press the  button to confirm. ↓ Return to the function selection mode.

[F82] Input of line names is completed.

<A dot "." can be displayed at the bottom left of each digit>



During setting, when the appropriate digit is flashing, press the  and  buttons simultaneously for 1 second or longer. A dot will be displayed.

To remove the dot, perform the same button operation.

■[F90] Setting of all functions

All functions can be set one after the other, without having to select each one separately from the function selection mode.

<Operation>

Press the  or  button in function selection mode to display [F90] on the main screen.

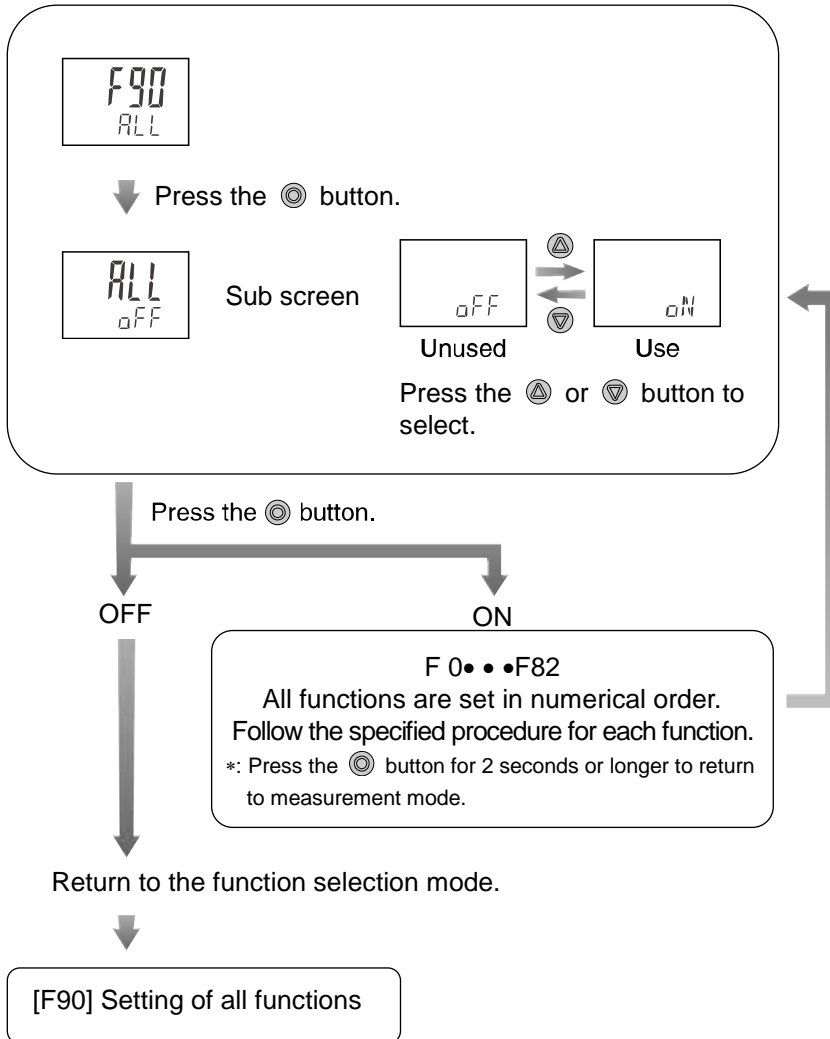



Turn the power off and turn it on again if the setting of analogue output is changed.

■[F96] Input value check

It is possible to check the voltage values (sensor output values) input to INPUT1 and 2.

<Operation>

Press the  or  button in function selection mode to display [F96] on the main screen.

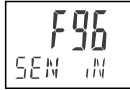

↓ Press the  button.

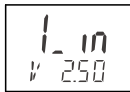

Displays the voltage value currently selected on the sub screen.

↓ Press the  button.

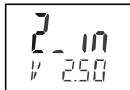

Displays the voltage value currently selected on the sub screen.

Press the  button. ↓ Return to the function selection mode.

[F96] Input value check is completed.

*: If 0 V is input to INPUT1 and INPUT2, the input displayed may not be zero due to the adjustment error of the electric circuit. However, this is not an error. When input values are entered, they will be displayed correctly.

■[F97] Selection of copy function

The set values can be copied. The set values of flow rate and functions can be copied. When the output specifications (switch output or analogue output) and/or unit specifications are the same, this function becomes available. The set value can be copied up to 10 switches simultaneously.

<Connection>

Connect the pressure switches after turning off the power supply.

Connect the master flow monitor and the slave flow monitors with copy lead wire (ZS-40-Y), and turn on the power supply.

The master flow monitor is the flow monitor from which the setting is copied.

The slave flow monitor is the monitor to which the setting is copied.

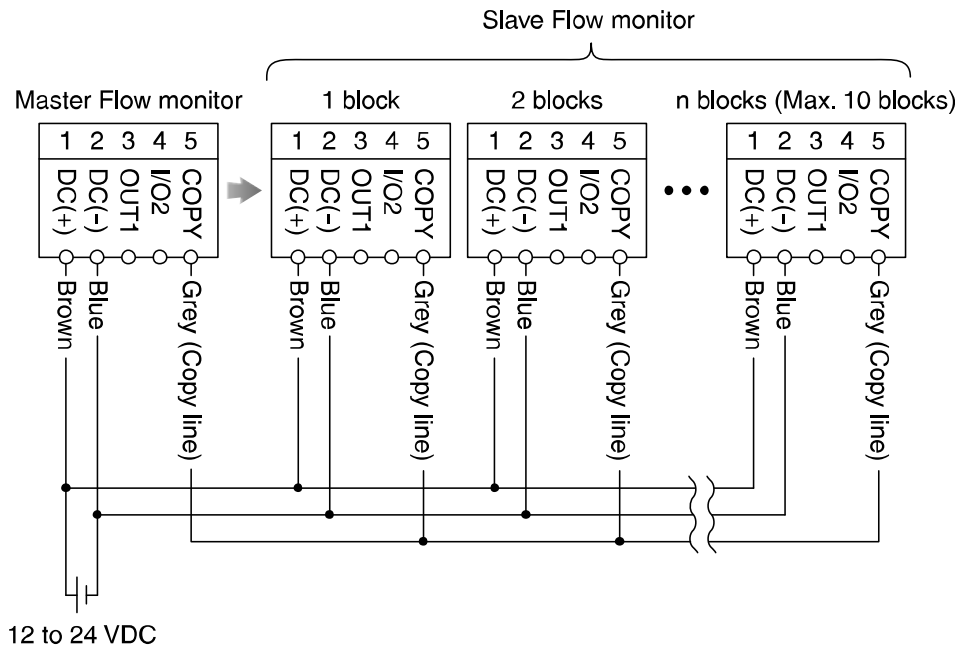



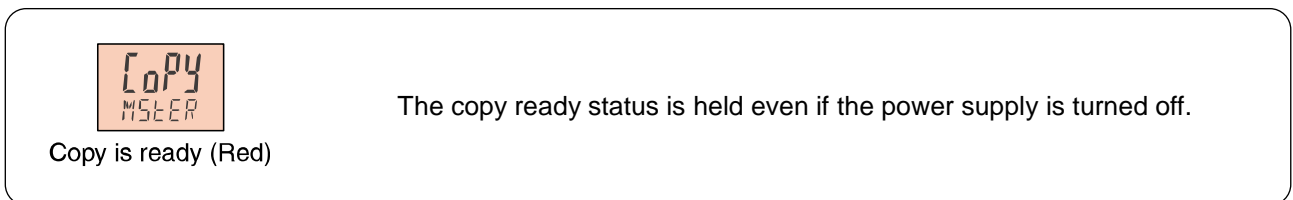
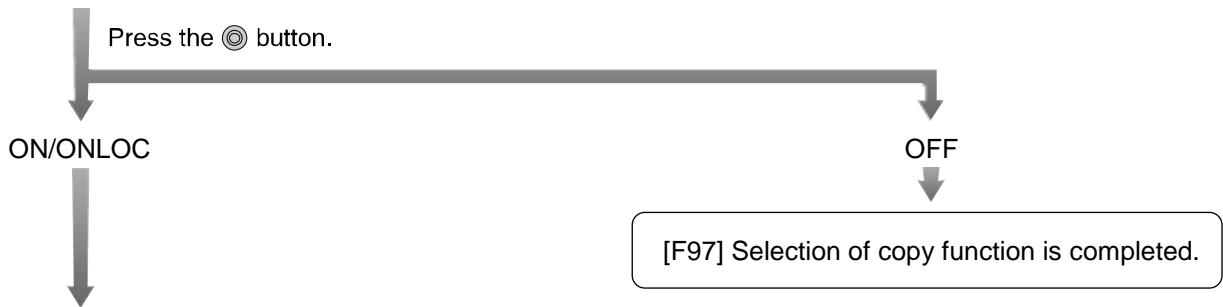
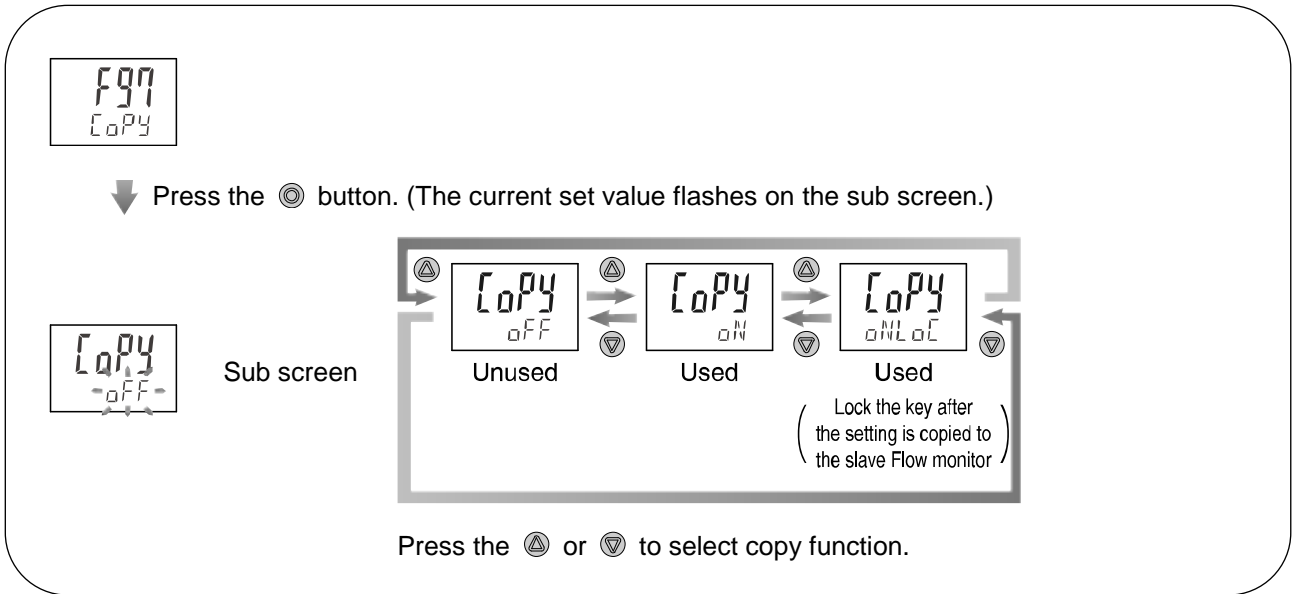

<Operation>

Press the ▲ or ▼ button to operate the master flow monitor in the function selection mode, and display [F97] on the main screen.

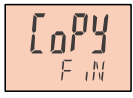

Press the ● button to start copying. ↓ (Continued)

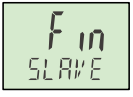

	Master flow monitor	Slave flow monitor
Sending/ Receiving	 Flashing * (Red)	 Flashing * (Green)
Copy completed	 Lights up (Red)	Displayed alternately  ↔  (Green)



*: They may not flash due to the timing.

Press the  button.

Successive copy is possible.
The copy ready status is held even if the power supply is turned off.

Copy is ready (Red)



When completing copy function, press the  and  buttons simultaneously for 1 second at least.

*: Press the  and  buttons simultaneously for 1 second at least.

Press the  button.

[F97] Selection of copy function is completed.

Return to the measurement mode.

*: If the copy to the slave flow monitor is not completed, it is detected as a copying function sending/receiving error. Press the  and  buttons simultaneously for 1 second at least to return to the measurement mode. Then, check the wiring of the switch and retry copy function.

■[F98] Output check

The output check can be turned on irrespective of flow conditions so that the circuit wiring can be checked. For the analogue output type, when ON the output will be 5 V or 20 mA, and when OFF 1 V or 4 mA.

<Operation>

Press the or button in function selection mode to display [F98] on the main screen.

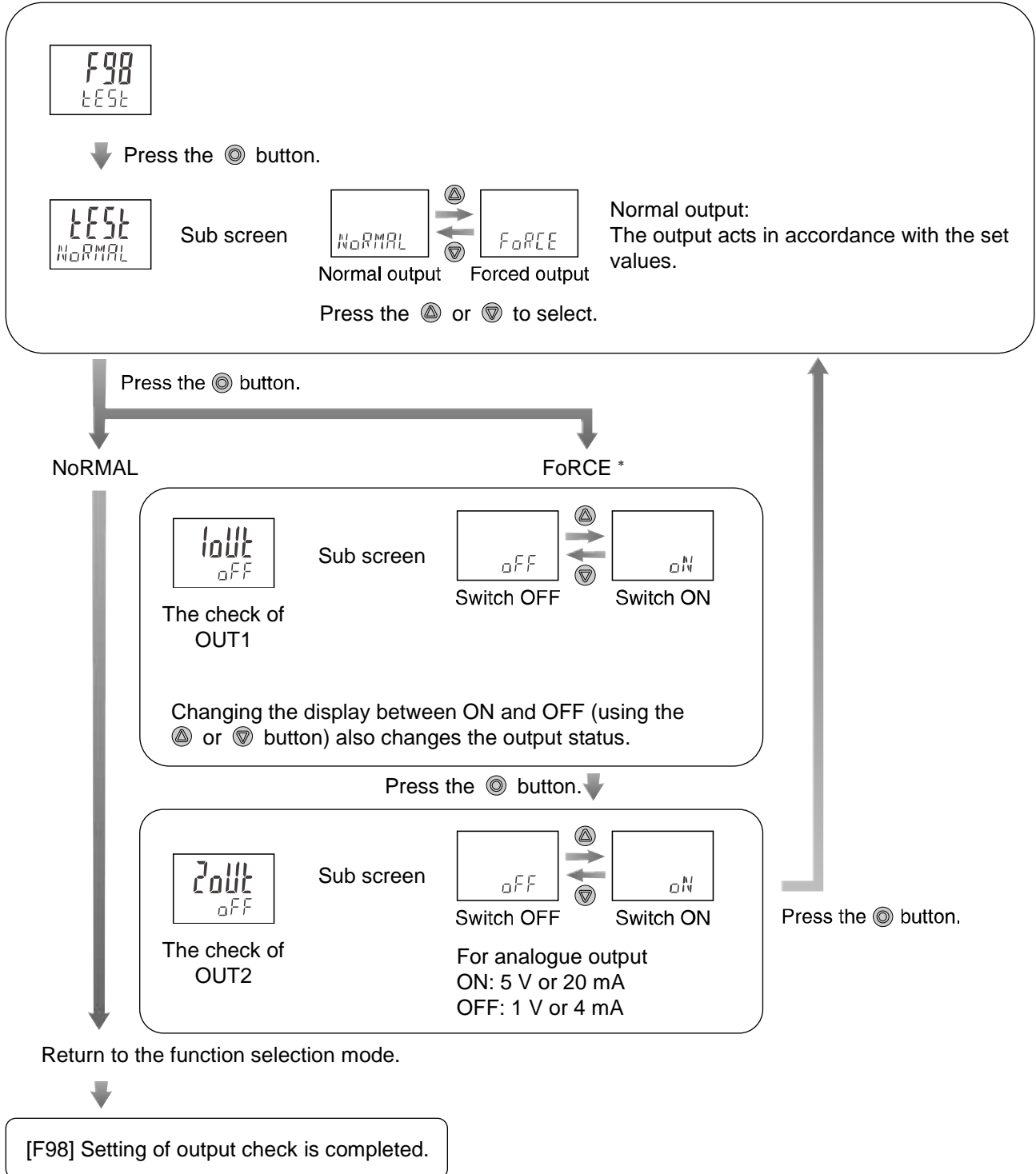



*: Press the button for 2 seconds or longer to return to measurement mode.

*: An increase or decrease in flow will have no effect on the output while the output check function is being performed.

■[F99] Reset to the default settings

The factory default values can be restored.

<Operation>

Press the  or  button in function selection mode to display [F99] on the main screen.





↓ Press the  button.



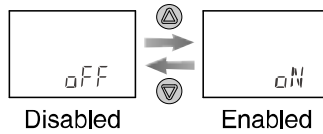

Sub screen



Press the  or  button to display "ON".

*: To return to measurement mode without changing any settings press the  button for 2 seconds or longer.

Press the  and  buttons simultaneously for 5 seconds or longer to restore the default settings.



The device automatically returns to function selection mode.



[F99] Reset to the default settings is completed.

Other Settings

- **Reset of the accumulated flow**

When the accumulated value display is selected, the accumulated value can be reset.



<Operation>

While the accumulated value is displayed, press the  and  buttons simultaneously for 1 second or longer.

- **Reset of the peak value**

When the peak value display is selected, the peak value can be reset to zero.



<Operation>

While the peak value is displayed, press the  and  buttons simultaneously for 1 second or longer.

- **Reset of the bottom value**

When the bottom value display is selected, the bottom value can be reset to zero.

<Operation>

While the bottom value is displayed, press the  and  buttons simultaneously for 1 second or longer.

●Key-lock function

This function is to prevent errors occurring due to such things as set values being accidentally changed. While the keys are locked, it is possible to view the set values on the sub screen.

<Operation with keys locked>

Simple check of set values

If the  button is pressed, [LoC] is displayed on the sub screen for approximately 1 second.

When the  button is released with [LoC] still displayed, the sub screen will scroll through the set values.

After the scrolling of set values is finished, [LoC] is displayed for approx. 1 second, the product then returns to measurement mode

Pressing the  or  buttons will change the sub screen display.

The peak and bottom hold values and the accumulated value can be viewed, but not cleared.

<Operation – Without security code input>

1. Press and hold the  button for 5 seconds or longer in measurement mode.

The current setting [LoC] or [UnL] will be displayed on the sub screen.

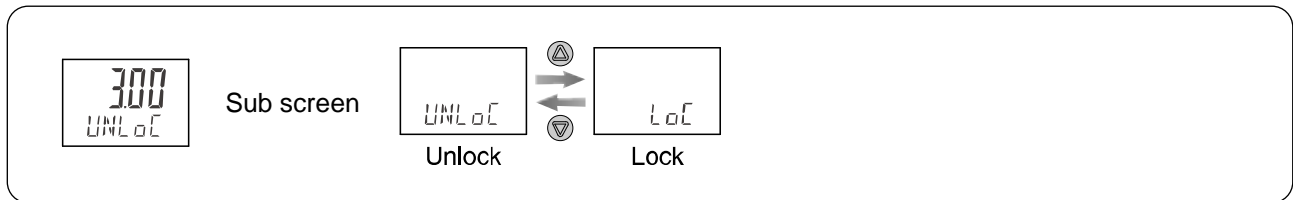

2. Press either the  or  button to select locking/unlocking the keys.

3. Press the  button to confirm. Return to the measurement mode.

To release key-lock, repeat the above operation.

*: The keys cannot be locked or released while the sub screen is displayed the set values under this function. Perform the operation in measurement mode.

<Operation – With security code>



The procedure to lock the keys is the same as that for "without security code".

●Unlocking

1. Press and hold the  button for 5 seconds or longer in measurement mode.

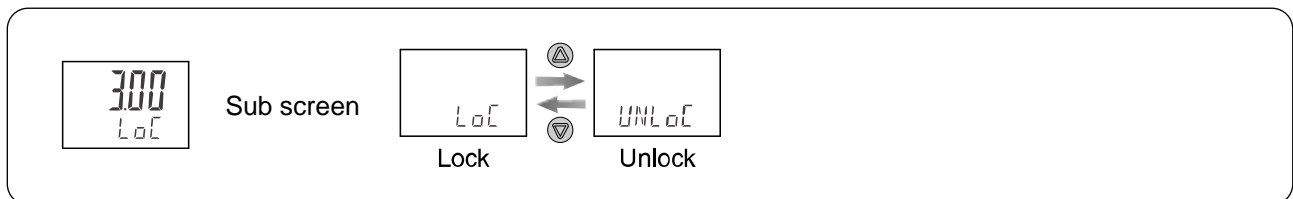
[LoC] will be displayed on the sub screen.



2. Press either the  or  button to select unlocking the keys [UnLoC].

3. After the  button is pressed, the security code must be input.

4. Input of security code (3 digit setting)

The hundreds digit starts flashing.

Press the ▲ or ▼ button to change the set value.

Press the ◎ button to make the next value to the right flash.

(If the ◎ button is pressed on the far right digit, the hundreds digit will flash.)

After the setting is complete, press the ◎ button continuously for 1 second or longer.

(If an operation is not performed for 30 seconds during input or change of the security code, it will return to measurement mode with [LoC] status.)

If the password is wrong, [FAL] will be displayed on the sub screen. In this case, input the password again.

If the wrong security code is entered 3 times, it will return to measurement mode.

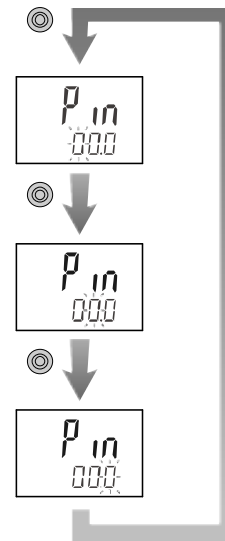

[UnLoC] is displayed on the sub screen.



Press the ◎ button to complete the unlocking operation.

● Change of security code

In the default setting, security code entry is set to [000], but this can be changed to any number.

<Operation>

1. After the key lock setting is complete, perform all four steps in the key unlocking procedure. (Refer to Key-lock function on page 61.)

2. After the security code is entered and the indication changes to [UnLoC] on the sub screen, press and hold the ◎ and ▼ buttons simultaneously for 5 seconds or longer.

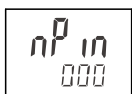

[000] is displayed and the new security code should be input. For how to input the security code, refer to "4" Input of security code on page 62.



Press the ◎ button for 1 second or longer.

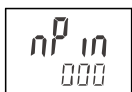

The new security code is displayed on the sub screen.



Press the ◎ button for 1 second or longer.

The change of security code is complete.

The status remains [UnLoC] after the change is completed, so perform the key lock setting again to change it to [LoC].

Maintenance

How to reset the product after a power cut or when the power has been unexpectedly removed

The settings of the product are retained from before the power cut or de-energizing.

The output condition also recovers to that before the power cut or de-energizing, but may change depending on the operating environment.

Therefore, check the safety of the whole system before operating the product.

Troubleshooting

Troubleshooting

Applicable Flow monitor: PF3W3 series

If an operation failure occurs with the product, use the chart below to find out the cause of problem.



If a cause applicable to the failure cannot be identified and normal operation can be recovered by replacement with a new product, this indicates that the product itself was faulty. The damage to the product may have been caused by operating environment (network construction, etc.). Consult with SMC separately to obtain countermeasures.

Cross-reference for troubleshooting

Fault	Detail	Possible cause	Item to check	Recommended action
Incorrect display	No display	Incorrect wiring	Check if the brown wire DC(+) and blue wire DC(-) are connected correctly.	Correct the wiring.
		Loose connector	Check that the connector is connected.	Connect the connector.
	The display is unstable.	Foreign matter has entered or got stuck inside the flow passage of the sensor.	Confirm whether foreign matter may enter.	We recommend a filter with filtration of approx. 40 mesh.
		Piping is connected in the wrong direction.	Confirm whether the mounting direction of the product corresponds to the flow direction.	Make the mounting direction correspond to the flow direction.
		Insufficient water supply	Confirm whether the fluid path is full.	Fill up the fluid path.
		Pulsation in the flow.	Confirm whether the supply pressure fluctuates, or whether pulsation is generated due to the characteristics of the compressor or pump used as the pressure source.	Change to a pump that has less pulsation. Install a tank to reduce the pressure fluctuation. Change the piping to elastic piping such as rubber hose.
	Incorrect display	Foreign matter has entered or got stuck inside the flow passage of the sensor.	Confirm whether foreign matter may enter.	We recommend a filter with filtration of approx. 40 mesh.
		Piping is connected in the wrong direction.	Confirm whether the mounting direction of the product corresponds to the flow direction.	Make the mounting direction correspond to the flow direction.
		Insufficient water supply	Confirm whether the fluid path is full.	Fill up the fluid path.
		The flow rate range of the product to be connected is selected incorrectly.	Confirm whether the flow rate range is correctly selected.	Select the correct flow rate range.
	Flow does not start.	The flow adjustment valve is closed.	Check the condition of the flow adjustment valve.	Open the flow adjustment valve to get appropriate flow.

Fault	Detail	Possible cause	Item to check	Recommended action
Incorrect display	Even though the flow rate is zero, it is displayed.	Operation of pump while the flow adjustment valve is closed.	Check the condition of the flow adjustment valve and pump.	Open the flow adjustment valve slightly, and let the pulsation (pressure) from the pump escape.
Incorrect output	No output	Incorrect wiring	Check if the brown wire DC(+), blue wire DC(-), black wire(OUT1) and white wire(OUT2) are connected correctly.	Correct the wiring.
		Loose connector	Check that the connector is connected.	Connect the connector.
	Output is unstable.	Foreign matter has entered or got stuck inside the flow passage of the sensor.	Confirm whether foreign matter may enter.	We recommend a filter with filtration of approx. 40 mesh.
		Piping is connected in the wrong direction.	Confirm whether the mounting direction of the product corresponds to the flow direction.	Make the mounting direction correspond to the flow direction.
		Insufficient water supply	Confirm whether the fluid path is full.	Fill up the fluid path.
		Pulsation in the flow.	Confirm whether the supply pressure fluctuates, or whether pulsation is generated due to the characteristics of the compressor or pump used as the pressure source.	Change to a pump that has less pulsation. Install a tank to reduce the pressure fluctuation. Change the piping to elastic piping such as rubber hose.
Hysteresis value too low.	Confirm to what level the hysteresis is set.	Increase the hysteresis set value.		
Push buttons not operating.	No reaction when the buttons are pressed.	Key-lock mode is activated.	Check if "LoC" displayed when the button is pressed.	Cancel the key-lock function. (Refer to page 61.)
Improper operation of the external input.	No reaction to the external input.	Incorrect wiring	Check if the brown wire DC(+), blue wire DC(-), black wire(OUT1) and white wire(OUT2) are connected correctly.	Correct the wiring.
		The input duration is too short.	Confirm whether the input line is connected to GND for a minimum of 30 msec.	When the external input is applied, the input line must be connected to GND for a minimum of 30 msec.
Incorrect temp. sensor displays.	The temp. is not displayed.	Setting condition of the sub screen	Check the content of the sub screen.	Set the sub screen to the temperature display.
		Connector loose	Check that the connector is connected.	Connect the connector.
	Incorrect display	Insufficient water supply	Confirm whether the fluid path is full.	Fill up the fluid path.
		Foreign matter	Check if foreign matter is stuck to the sensor.	Remove foreign matter.

Error indication function

Error Name	Display	Type	Troubleshooting
OUT1 over current error	Er 1	A load current of 80 mA or more is flowing to the switch output (OUT1).	Turn the power off and remove the cause of the over current. Then turn the power on again.
OUT2 over current error	Er 2	A load current of 80 mA or more is flowing to the switch output (OUT2).	
Excessive instantaneous flow	HHH	The applied flow rate is above approx. 110% of maximum rated flow.	Reset applied flow to a level within the display range.
Sensor disconnection error	LLL	The remote sensor is not connected to the monitor, or the sensor output is below 0.6 V.	Connect the sensor, or check the sensor output voltage.
Excessive accumulated flow	 (Displayed alternately)	The accumulated flow range is exceeded. (In some flow ranges, the decimal point may flash.)	Clear the accumulated flow. (Press the  and  buttons simultaneously for 1 second or longer.)
Temperature upper limit exceeded	cHHH	The fluid temperature is above 110 °C.	Reduce the fluid temperature.
Temperature lower limit exceeded	cLLL	The fluid temperature is below -10 °C.	Increase the fluid temperature.
Temperature sensor disconnection error		The temperature sensor output is not connected.	Connect the temperature sensor output line.
Temperature sensor failure		The remote sensor does not have a temperature sensor.	Check the whether the temperature can be measured with the remote sensor.
		If an error is displayed even if measures are taken to improve the "exceeding temperature lower limit" and "temperature sensor is not connected", the temperature sensor of the remote sensor might be broken.	Contact SMC for repair.
System error	Er 0 Er 4 Er 6 Er 8	Internal data error has occurred.	Turn the power off and turn it on again. If the failure cannot be solved, contact SMC for repair.

If the error cannot be reset after the above measures are taken, then please contact SMC.

Specification

■ Specifications

Specifications of the product

Model	PF3W30□																																													
Applicable sensor	PF3W504	PF3W520	PF3W540	PF3W511	PF3W521																																									
Rated flow range	0.5 to 4 L/min	2 to 16 L/min	5 to 40 L/min	10 to 100 L/min	50 to 250 L/min																																									
Display flow range	0.35 to 4.50 L/min (Displays 0.00 when the value is below 0.35 L/min)	1.7 to 18.0 L/min (Displays 0.0 when the value is below 1.7 L/min)	3.5 to 45.0 L/min (Displays 0.0 when the value is below 3.5 L/min)	7 to 112 L/min (Displays 0 when the value is below 7 L/min)	20 to 280 L/min (Displays 0 when the value is below 20 L/min)																																									
Switch point range	0.35 to 4.50 L/min	1.7 to 18.0 L/min	3.5 to 45.0 L/min	7 to 112 L/min	20 to 280 L/min																																									
Min. setting unit	0.01 L/min	0.1 L/min		1 L/min	2 L/min																																									
Conversion of accumulated pulse (Pulse width = 50 ms)	0.05 L/pulse	0.1 L/pulse	0.5 L/pulse	1 L/pulse	2 L/pulse																																									
Display unit	L/min for real-time flow and L for accumulated flow																																													
Accuracy	±0.5%F.S. max. Display and analogue output																																													
Repeatability	±0.5%F.S. max.																																													
Temperature characteristics	±0.5%F.S. max. (25 °C reference)																																													
Accumulated flow range *1	99999999.9 L		999999999 L																																											
	By 0.1 L	By 0.5 L	By 1 L																																											
Switch output	NPN or PNP open collector output																																													
<table border="1" style="width: 100%; border-collapse: collapse;"> <tr> <td style="width: 15%;">Max. load current</td> <td colspan="5" style="text-align: center;">80 mA</td> </tr> <tr> <td>Max. applied voltage</td> <td colspan="5" style="text-align: center;">28 VDC</td> </tr> <tr> <td>Internal voltage drop</td> <td colspan="5" style="text-align: center;">NPN: 1 V max. (at 80 mA load current) PNP: 1.5 V max. (at 80 mA load current)</td> </tr> <tr> <td>Response time *2</td> <td colspan="5" style="text-align: center;">1 s/2 s</td> </tr> <tr> <td>Output protection</td> <td colspan="5" style="text-align: center;">Short circuit protection</td> </tr> <tr> <td rowspan="2">Output mode</td> <td>Flow</td> <td colspan="4" style="text-align: center;">Select one of the output (hysteresis or window comparator mode), the output for the accumulated flow and the accumulated pulse output.</td> </tr> <tr> <td>Temp.</td> <td colspan="4" style="text-align: center;">Select the output for fluid temperature (hysteresis or window comparator mode).</td> </tr> </table>	Max. load current	80 mA					Max. applied voltage	28 VDC					Internal voltage drop	NPN: 1 V max. (at 80 mA load current) PNP: 1.5 V max. (at 80 mA load current)					Response time *2	1 s/2 s					Output protection	Short circuit protection					Output mode	Flow	Select one of the output (hysteresis or window comparator mode), the output for the accumulated flow and the accumulated pulse output.				Temp.	Select the output for fluid temperature (hysteresis or window comparator mode).								
	Max. load current	80 mA																																												
	Max. applied voltage	28 VDC																																												
	Internal voltage drop	NPN: 1 V max. (at 80 mA load current) PNP: 1.5 V max. (at 80 mA load current)																																												
	Response time *2	1 s/2 s																																												
	Output protection	Short circuit protection																																												
Output mode	Flow	Select one of the output (hysteresis or window comparator mode), the output for the accumulated flow and the accumulated pulse output.																																												
	Temp.	Select the output for fluid temperature (hysteresis or window comparator mode).																																												
Analogue output	Response time *3	1 s/2 s																																												
	Voltage output	Output voltage: 1 to 5 V, Output impedance: 1 kΩ																																												
	Current output	Output current: 4 to 20 mA Maximum load impedance: 300 Ω for 12 VDC, 600 Ω for 24 VDC.																																												

Model	PF3W30□	
Hysteresis	Variable	
External input	Voltage free input of 0.4 V or less (reed or solid state type) for 30 ms or longer	
Input/Output	Input for copy mode	
Display method	2-screen display (Main screen: 4-digit, 7-segment, 2-colour; red/green, Sub screen: 6-digit, 11-segment, white) Display updating frequency 5 times/sec.	
Indicator light	Output 1 and 2: Orange	
Power supply voltage	12 to 24 VDC ±10%	
Current consumption	50 mA max.	
Connection	Power supply output 5P connector, sensor connection 4P connector (e-con)	
Environment	Enclosure	IP40 (Note that the display front is only certified as IP65 by using optional parts (panel mount adapter and waterproof seal)).
	Operating temp. range	0 to 50 °C (No freezing and condensation)
	Operating humidity range	Operation, Storage: 35 to 85%R.H. (No condensation)
	Withstand voltage	1000 VAC, 1 minute between the terminals and housing
	Insulation resistance	50 MΩ min. (with 500 VDC) between the terminals and housing
Standards and regulations	CE marking, UL(CSA), RoHS	
Weight	Without lead wire	50 g
	With lead wire	100 g

*1: The accumulated value will be cleared by turning off the power supply. It is possible to select the function to memorize it. (Every 2 or 5 minutes.)

When 5 minutes interval is selected, take into consideration the maximum number of times it is possible to write to the memory device (electronic part), which is 1 million times (5 minutes x 1 million times = 5 million minutes = Approx. 9.5 years for 24 hour energizing). Calculate the life in your operating conditions before using the memorizing function and use within this range.

*2: The response time is when the set value is 90% in relation to the step input. (The value will be 7 s for the temperature sensor output.)

*3: The response time is when the set value reaches 90% in relation to the step input and linked with the switch output. (The value will be 7 s for the temperature sensor output.)

Specifications of lead wire (ZS-40-W)

Items	Specifications	
Conductor	Nominal cross-section area	AWG26
	Outside diameter	Approx. 0.51 mm
Insulator	Outside diameter	Approx. 1.00 mm
	Colours	Brown, blue, black, white and grey
Sheath	Outer diameter	φ3.5 mm

Specifications of temperature sensor

Items	Specifications
Rated temperature range	0 to 100 °C *1
Setting/display temperature range	-10 to 110 °C
Min. setting unit	1 °C
Display unit	°C
Analogue output accuracy	±3%F.S.
Response time	7 s *2
Ambient temperature characteristics	±5%F.S.

*1: The rated temperature range is only for the temperature sensor. As a whole product, the fluid temperature range is specified as 0 to 90 °C.

*2: The response time is only for the temperature sensor.

Flow specification of the specified order (flow unit: gal)

Model		PF3W504	PF3W520	PF3W540	PF3W511	PF3W521
Rated flow range		0.13 to 1.06 gal/min	0.53 to 4.23 gal/min	1.3 to 10.6 gal/min	2.6 to 26.4 gal/min	13 to 66 gal/min
Instantaneous flow	Display flow range	0.09 to 1.18 gal/min (Flow under 0.09 L/min is displayed as "0.00".)	0.45 to 4.75 gal/min (Flow under 0.45 L/min is displayed as "0.00".)	0.9 to 11.8 gal/min (Flow under 0.9 L/min is displayed as "0.0".)	1.8 to 29.5 gal/min (Flow under 1.8 L/min is displayed as "0.0".)	5 to 73 gal/min (Flow under 5 L/min is displayed as "0".)
	Setting flow range	0.09 to 1.18 gal/min	0.45 to 4.75 gal/min	0.9 to 11.8 gal/min	1.8 to 29.5 gal/min	5 to 73 gal/min
	Min. setting/display unit	0.01 gal/min		0.1 gal/min		1 gal/min
Accumulated flow	Setting/display flow unit	99999999.9 gal	999999999 gal			
	Min. setting/display unit	0.1 gal	1 gal			
Conversion of accumulated pulse		0.01 gal/pulse	0.05 gal/pulse	0.1 gal/pulse	0.5 gal/pulse	1 gal/pulse

Temperature specification of the specified order (temp. unit: °F)

Rated temperature range *	32 to 212 °F
Setting/display temperature range	14 to 230 °F
Min. setting/display unit	1 °F

*: The rated temperature range is only for the temperature sensor. As a whole product, the fluid temperature range is specified as 0 to 90 °C.

■ Characteristics graph

Analogue output (Flow)

(PF3W504/520/540)

	A	B	C
Voltage output	1 V	1.5 V	5 V
Current output	4 mA	6 mA	20 mA

(PF3W511)

	A	B	C
Voltage output	1 V	1.4 V	5 V
Current output	4 mA	5.6 mA	20 mA

(PF3W521)

	A	B	C
Voltage output	1 V	1.5 V	5 V
Current output	4 mA	5.9 mA	20 mA

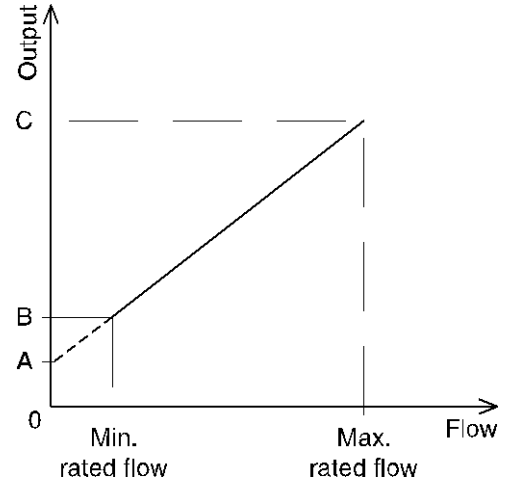

Sensor model	Rated flow [L/min]	
	Minimum	Maximum
PF3W504	0.5	4
PF3W520	2	16
PF3W540	5	40
PF3W511	10	100
PF3W521	30	250

Analogue output (Fluid temperature)

	A	B	C	D
Voltage output	0.6 V	1 V	5 V	5.4 V
Current output	2.4 mA	4 mA	20 mA	21.6 mA

Be sure to connect to a flow sensor with a temperature sensor.

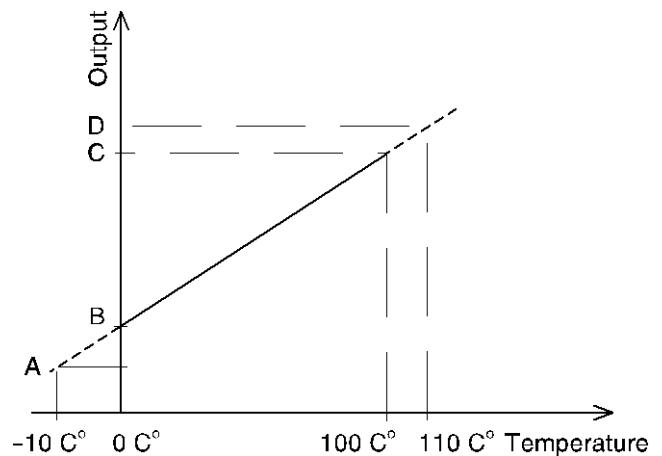

■ Dimensions

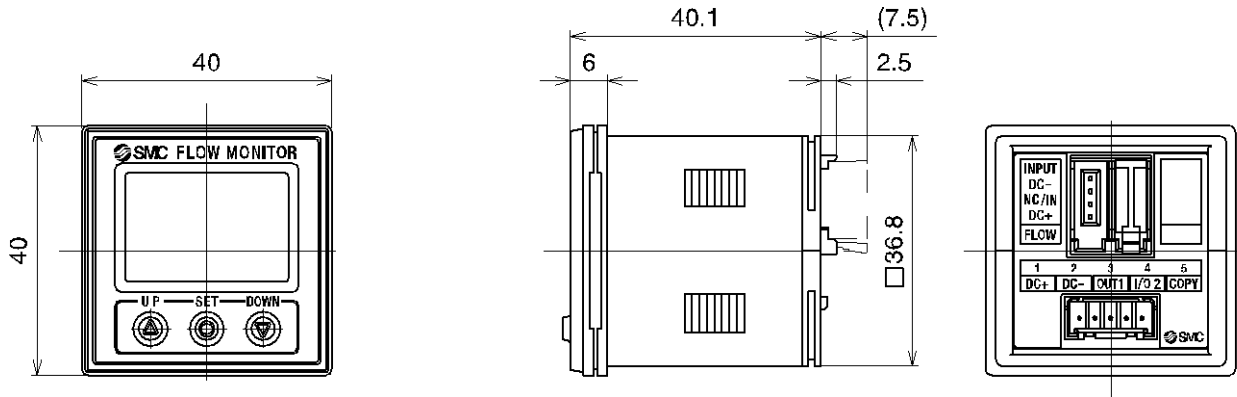

Front protective cover + Panel mount adapter

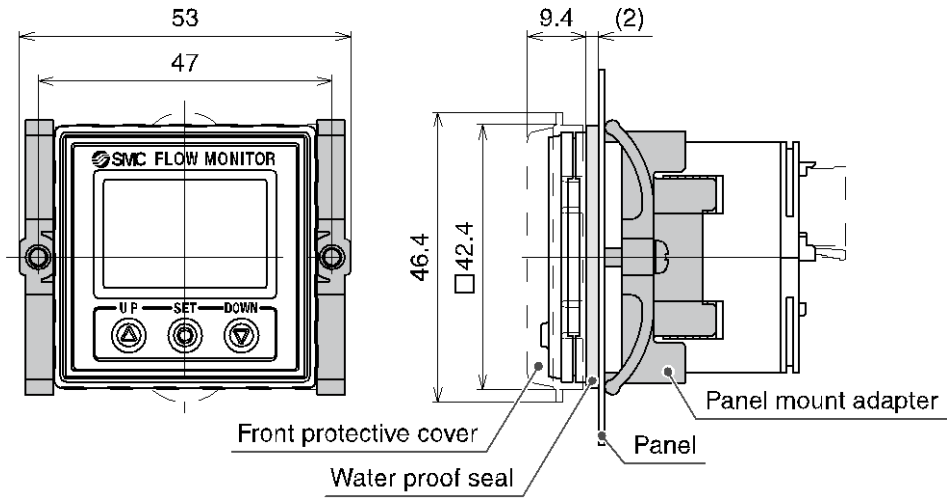

Cut-out dimensions for panel mounting

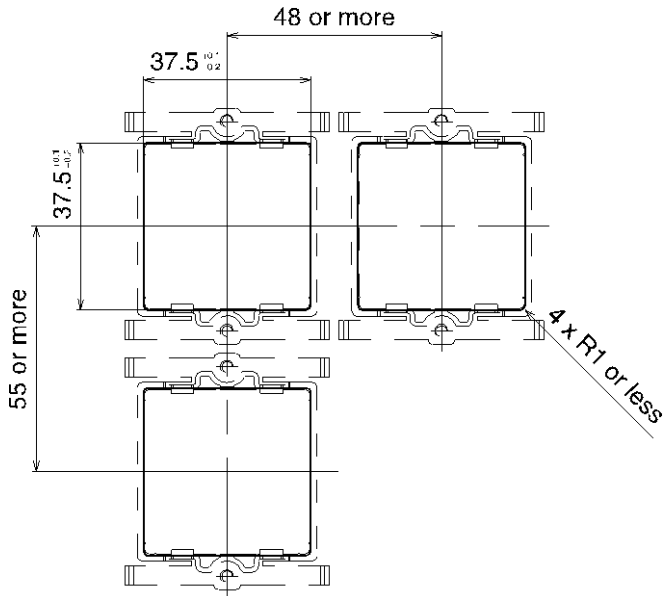

*: The thickness of the panel is 0.5 to 8 mm (with a waterproof seal: 0.5 to 6 mm)

Dimensions of power supply/output lead wire (ZS-40-W)

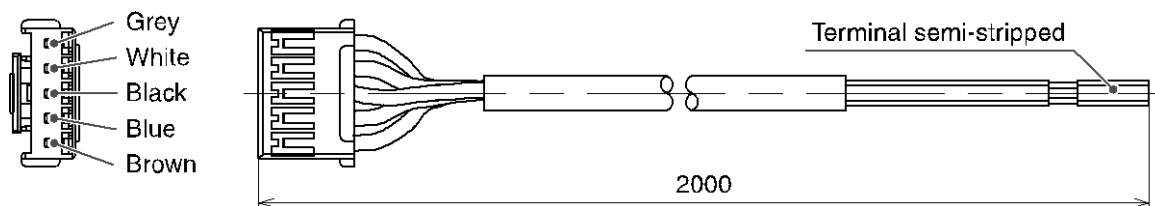

Revision history

A: Add the product model.
B: Contents revised in several places.
C: Contents revised in several places.
D: Contents revised in several places.
E: Contents revised in several places.
F: Contents revised in several places.
G: Contents revised in several places. [July 2018]

SMC Corporation

4-14-1, Sotokanda, Chiyoda-ku, Tokyo 101-0021 JAPAN

Tel: + 81 3 5207 8249 Fax: +81 3 5298 5362

URL <http://www.smcworld.com>

Note: Specifications are subject to change without prior notice and any obligation on the part of the manufacturer.
© 2011-2018 SMC Corporation All Rights Reserved

