



Operation Manual

PRODUCT NAME

Digital Pressure Switch

MODEL / Series / Product Number

ISE70
ISE75(H)

SMC Corporation

Table of Contents

Safety Instructions	2
Model Indication and How to Order	9
Summary of Product parts	10
Definition and terminology	11
Mounting and Installation	14
Piping	14
Installation	14
Wiring	15
Setting and Adjustment	17
Initializing	17
Pressure setting	22
Setting of function	24
Maintenance	26
Troubleshooting	27
Specification	35
Specifications	35
Dimensions	37



Safety Instructions

These safety instructions are intended to prevent hazardous situations and/or equipment damage. These instructions indicate the level of potential hazard with the labels of "Caution", "Warning" or "Danger". They are all important notes for safety and must be followed in addition to International Standards (ISO/IEC)*1), and other safety regulations.

*1) ISO 4414: Pneumatic fluid power -- General rules relating to systems.

ISO 4413: Hydraulic fluid power -- General rules relating to systems.

IEC 60204-1: Safety of machinery -- Electrical equipment of machines. (Part 1: General requirements)

ISO 10218: Manipulating industrial robots -Safety.

etc.



Caution

Caution indicates a hazard with a low level of risk which, if not avoided, could result in minor or moderate injury.



Warning

Warning indicates a hazard with a medium level of risk which, if not avoided, could result in death or serious injury.



Danger

Danger indicates a hazard with a high level of risk which, if not avoided, will result in death or serious injury.

Warning

1. The compatibility of the product is the responsibility of the person who designs the equipment or decides its specifications.

Since the product specified here is used under various operating conditions, its compatibility with specific equipment must be decided by the person who designs the equipment or decides its specifications based on necessary analysis and test results.

The expected performance and safety assurance of the equipment will be the responsibility of the person who has determined its compatibility with the product.

This person should also continuously review all specifications of the product referring to its latest catalog information, with a view to giving due consideration to any possibility of equipment failure when configuring the equipment.

2. Only personnel with appropriate training should operate machinery and equipment.

The product specified here may become unsafe if handled incorrectly.

The assembly, operation and maintenance of machines or equipment including our products must be performed by an operator who is appropriately trained and experienced.

3. Do not service or attempt to remove product and machinery/equipment until safety is confirmed.

1. The inspection and maintenance of machinery/equipment should only be performed after measures to prevent falling or runaway of the driven objects have been confirmed.

2. When the product is to be removed, confirm that the safety measures as mentioned above are implemented and the power from any appropriate source is cut, and read and understand the specific product precautions of all relevant products carefully.

3. Before machinery/equipment is restarted, take measures to prevent unexpected operation and malfunction.

4. Contact SMC beforehand and take special consideration of safety measures if the product is to be used in any of the following conditions.

1. Conditions and environments outside of the given specifications, or use outdoors or in a place exposed to direct sunlight.

2. Installation on equipment in conjunction with atomic energy, railways, air navigation, space, shipping, vehicles, military, medical treatment, combustion and recreation, or equipment in contact with food and beverages, emergency stop circuits, clutch and brake circuits in press applications, safety equipment or other applications unsuitable for the standard specifications described in the product catalog.

3. An application which could have negative effects on people, property, or animals requiring special safety analysis.

4. Use in an interlock circuit, which requires the provision of double interlock for possible failure by using a mechanical protective function, and periodical checks to confirm proper operation.



Safety Instructions

Caution

1. The product is provided for use in manufacturing industries.

The product herein described is basically provided for peaceful use in manufacturing industries. If considering using the product in other industries, consult SMC beforehand and exchange specifications or a contract if necessary.
If anything is unclear, contact your nearest sales branch.

Limited warranty and Disclaimer/Compliance Requirements

The product used is subject to the following "Limited warranty and Disclaimer" and "Compliance Requirements".

Read and accept them before using the product.

Limited warranty and Disclaimer

1. The warranty period of the product is 1 year in service or 1.5 years after the product is delivered, whichever is first.*2)

Also, the product may have specified durability, running distance or replacement parts. Please consult your nearest sales branch.

2. For any failure or damage reported within the warranty period which is clearly our responsibility, a replacement product or necessary parts will be provided.

This limited warranty applies only to our product independently, and not to any other damage incurred due to the failure of the product.

3. Prior to using SMC products, please read and understand the warranty terms and disclaimers noted in the specified catalog for the particular products.

***2) Vacuum pads are excluded from this 1 year warranty.**

A vacuum pad is a consumable part, so it is warranted for a year after it is delivered.

Also, even within the warranty period, the wear of a product due to the use of the vacuum pad or failure due to the deterioration of rubber material are not covered by the limited warranty.

Compliance Requirements

1. The use of SMC products with production equipment for the manufacture of weapons of mass destruction (WMD) or any other weapon is strictly prohibited.

2. The exports of SMC products or technology from one country to another are governed by the relevant security laws and regulation of the countries involved in the transaction. Prior to the shipment of a SMC product to another country, assure that all local rules governing that export are known and followed.

Caution

SMC products are not intended for use as instruments for legal metrology.

Products that SMC manufactures or sells are not measurement instruments that are qualified by pattern approval tests relating to the measurement laws of each country.

Therefore, SMC products cannot be used for business or certification ordained by the measurement laws of each country.

Operator

- ◆ This operation manual is intended for those who have knowledge of machinery using pneumatic equipment, and have sufficient knowledge of assembly, operation and maintenance of such equipment. Only those persons are allowed to perform assembly, operation and maintenance.
- ◆ Read and understand this operation manual carefully before assembling, operating or providing maintenance to the product.

■ Safety Instructions

Warning

- Do not disassemble, modify (including changing the printed circuit board) or repair.
An injury or failure can result.
- Do not operate the product outside of the specifications.
Do not use for flammable or harmful fluids.
Fire, malfunction, or damage to the product can result.
Verify the specifications before use.
- Do not operate in an atmosphere containing flammable or explosive gases.
Fire or an explosion can result.
This product is not designed to be explosion proof.
- Do not use the product in a place where static electricity is a problem.
Otherwise it can cause failure or malfunction of the system.
- If using the product in an interlocking circuit:
 - Provide a double interlocking system, for example a mechanical system
 - Check the product regularly for proper operationOtherwise malfunction can result, causing an accident.
- The following instructions must be followed during maintenance:
 - Turn off the power supply
 - Stop the air supply, exhaust the residual pressure and verify that the air is released before performing maintenanceOtherwise an injury can result.

Caution

- Do not touch the terminals and connectors while the power is on.
Otherwise electric shock, malfunction or damage to the product can result.
- After maintenance is complete, perform appropriate functional inspections and leak tests.
Stop operation if the equipment does not function properly or there is a leakage of fluid.
When leakage occurs from parts other than the piping, the product might be faulty.
Disconnect the power supply and stop the fluid supply.
Do not apply fluid under leaking conditions.
Safety cannot be assured in the case of unexpected malfunction.

■ NOTE

- Follow the instructions given below when designing, selecting and handling the product.
 - The instructions on design and selection (installation, wiring, environment, adjustment, operation, maintenance, etc.) described below must also be followed.
 - *Product specifications
 - Do not operate in an inflammable or harmful gas or liquid. (ISE70 series) Do not use SUS630, SUS430 and SUS304 with a corrosive or inflammable fluid. (ISE75/ISE75H series)
The compressed air must with contain chemicals, synthetic oil with organic solvent, salts and corrosive gas.
 - Do not use a poisonous and corrosive fluid. Do not use a combustible fluid either, as this Pressure switch is not designed to be explosion proof.
Air that includes these substances can cause damage or malfunction of the Pressure switch.
Verify the specifications carefully before use.
 - When the liquid is used as a fluid, there will be a sudden pressure fluctuation such as water hammer and surge pressure at the time of turning on and off the valve. As necessary, take measures by installing a bumper, absorber and accumulator.
A pressure over the specified proof pressure can break the pressure sensor and whole Pressure switch even it is instantaneous.
 - Do not use the compressed containing plenty of condensed water.
Otherwise it can cause malfunction of the Pressure switch.
When measuring the air with condensed water, install an air dryer/drain catch before a filter, and drain the condensed water regularly.
Improper draining of condensed water allows in the flow with condensed water into the secondary side and cause malfunction of pneumatic devices.
Use of the filter with an auto drain is recommended when the draining is difficult to perform.
Refer to our manual "Compressed air purifying system" for details of the quality of the compressed air.
 - Use the specified voltage.
Operation with a voltage outside of the specification can cause malfunction or damage of the Pressure switch.
Insufficient voltage may not drive a load due to a voltage drop inside the Pressure switch.
Verify the operating voltage of the load before use.
 - Use the specified ranges of the measurement flow rate and the specified operating pressure.
Otherwise it can cause damage to the Pressure switch and an abnormal measurement.
 - Do not exceed the specified maximum allowable load.
Otherwise it can cause damage or shorten the lifetime of the Pressure switch.
 - Input data to the Pressure switch is not erased after the power is off.
(Writing times: 100,000 times, Data duration: 10 years after power off.)

- Reserve a space for maintenance.

Consider the space for maintenance when designing the whole system.

- The direct-current power supply to combine should be UL1310 Class 2 power supply or the power supply using UL1585 Class 2 transformer.
- The Pressure switch is a UL approved product only if it has a  mark on the body.
- A pressure sensor of stainless steel diaphragm is used for this product. The pressure sensor can be damaged by the rush inertia of water when the drain contained in water and air collide with the pressure sensor when vacuum is broken after vacuum adsorption is confirmed, and it may cause malfunction with the pressure indication.

In the above case, make an orifice in the Location shown in the Fig. bellow.

Pipe an orifice vertically and so that no water (solution) remains between the product and orifice.

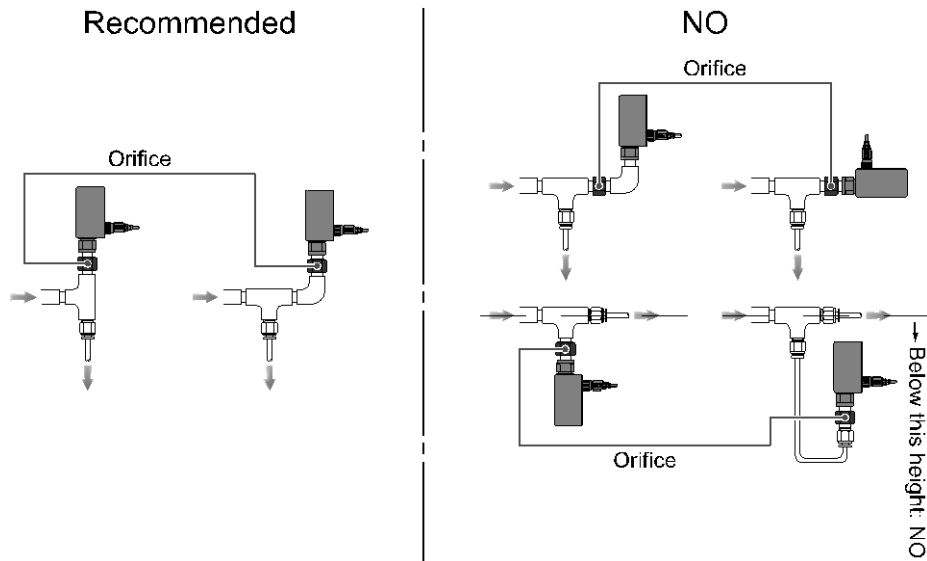

●Product handling

*Installation

- Do no drop, hit or apply shock to the Pressure switch.
Otherwise it can result in damage to the Pressure switch causing failure or malfunction.
- Do not pull lead wires or lift the body with lead wires. (Tensile force is 50N or less)
Hold the body when handling.
Otherwise it can result in damage of the Pressure switch causing failure or malfunction.
- The strength of the piping to screwing is 40 Nm for ISE70 and 80 Nm for ISE75(H). If a force over these values is given, the piping may be damaged.
- Apply a spanner to the spanner flat of the fitting horizontally for piping not to apply force on the Pressure switch body.
- Eliminate any dust left in the piping by air blow before connecting the piping to the Pressure switch.
Otherwise it can cause damage or malfunction.
- Clean the inside of the pipe of dust or tape sealant when screwing pipes or joints.
When using tape sealant, leave a couple of screw threads unwrapped with tape sealant.
Otherwise it can cause damage or malfunction.
- Check there is no leakage after connecting the piping of the Pressure switch.
- Do not insert wires or other foreign matter into the pressure measurement port.
It can damage the pressure sensor causing failure or malfunction.
- Be sure to ground terminal FG when using a switch-mode power supply obtained on the market.

*Wiring

- Avoid repeatedly bending or stretching the lead wires.
Wiring with repetitive bending stress or tensile stress can break of the lead wires.
Replace the Pressure switch when damage to the lead wires is observed.
The recommended bend radius of the lead wire is 6 times the outside diameter of the sheath, or 33 times the outside diameter of the insulation material, whichever is larger.
- Wire correctly.
Incorrect wiring can break the Pressure switch depending on a miswired circuit.
- Do not connect wires while the power is on.
Otherwise it can break the circuit inside the Pressure switch causing malfunction.
- Do not route wires and cables together with power or high voltage cables.
Otherwise the wires to the Pressure switch can be contaminated with noise or induced surge voltage from power or high voltage cables, which causes malfunction.
The wires to the Pressure switch other than those for power lines or high voltage lines.
- Confirm proper insulation of wiring.
Poor insulation (with other circuits, between terminals, etc.) can introduce over voltage or current to the Pressure switch, which causes damage.
- Keep wiring as short as possible to prevent contamination from noise and induced surge voltage.
Do not use a cable longer than 30 m. Consult with SMC for use with a cable longer than 30 m.
Connect the 0 V DC wire (blue line) directly or as close as possible to the 0 V DC terminal of the DC power supply.

*Environment

- Avoid exposure of this product to direct sunlight.

If using in a location directly exposed to sunlight, shade the Pressure switch from the sunlight. Otherwise it can cause failure or malfunction.

- Do not use in an area where surges are generated.

Internal circuit elements of the Pressure switch can deteriorate or break when equipment generating a large surge (electromagnetic lifter, high frequency induction furnace, motor, etc.) is located near the Pressure switch. Provide surge preventives, and avoid interference.

- Do not use a load which generates surge voltage.

Relays or solenoid valve generate surge voltage. When applying the Pressure switch to drive these loads directly, provide a surge suppressor.

- The Pressure switch is not resistive to a lightning surge defined in CE marking. Take measures to protect against the lightning surge at the load side.

- Mount the product in a place that is not exposed to vibration or impact.

Otherwise it can cause damage or malfunction.

- Follow the specified ranges of the operating fluid and ambient temperatures.

- Do not operate close to a heat source, or in a location exposed to radiant heat.

It can cause malfunction.

- When the Pressure switch is used in a place which is exposed to the splash of oil and solvent all the time, protect the Pressure switch from direct splash.

It can corrode and swell the seal (FKM) which causes the malfunction of the Pressure switch.

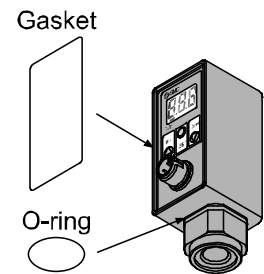

*Adjustment and Operation

- Do not short-circuit the load.

The Pressure switch indicates the error status when a load is short-circuited. However, over current can damage the Pressure switch.

- Do not press the setting buttons with a sharp pointed object.

It can cause damage to the setting buttons.

- If using the Pressure switch to detect very small pressure rates, warm up it for 20 to 30 minutes first.

There will be a drift on the display of approx. $\pm 1\%$ immediately after the power supply is turned on.

The indication drifts about $\pm 1\%$ soon after the power is on.

- Do not touch the LCD during operation.

The display on the LCD can be changed due to static electricity.

- When leakage occurred from other parts except piping, the pressure sensor might be broken.

Cut off power supply and stop supplying pressure. Don't apply pressure at leaking condition.

*Maintenance

- Before performing maintenance, make sure to turn off the power supply, stop supplied air, release the residual air (liquid) in the piping into the atmosphere, and verify that the pneumatic system is open to the air (liquid).

Otherwise an unexpected operation of the system component can occur.

- Perform maintenance and check regularly.

Otherwise an unexpected malfunction of the system can occur due to a malfunction of the Pressure switch.

- Perform proper functional checks and leak tests after maintenance.

Stop operation when an abnormality is observed such that the device does not work properly or there is a leakage of fluid.

Otherwise an unexpected malfunction of system component can occur.

- Drain condensed water regularly. (In case of using ISE70)

The flow with condensed water to the secondary side can cause the malfunction of pneumatic equipment.

- Do not use solvents such as benzene or thinner to clean the Pressure switch body.

It can damage the surface of the body and erase the indications on the body.

Use a soft cloth to remove stains. For heavy stains, use a cloth soaked with diluted neutral detergent and fully squeezed, then wipe up the stains again with a dry cloth.

Model Indication and How to Order

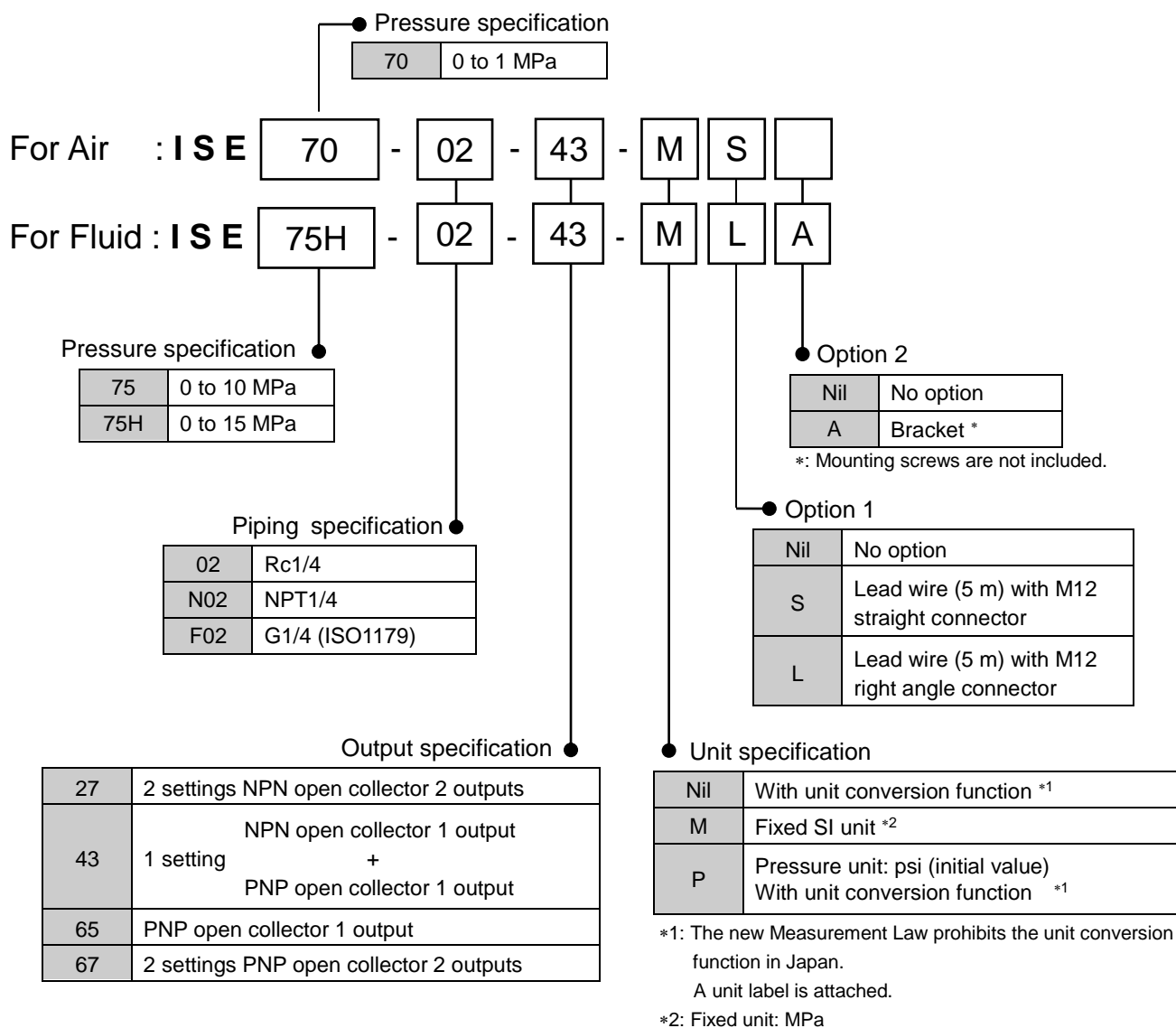

○Option Indications

Option	Part no.	Option
Bracket	ZS-31-A	A
Lead wire (5 m) with M12 straight connector	ZS-31-B	S
Lead wire (5 m) with M12 right angle connector	ZS-31-C	L

Summary of Product parts

Names of individual parts

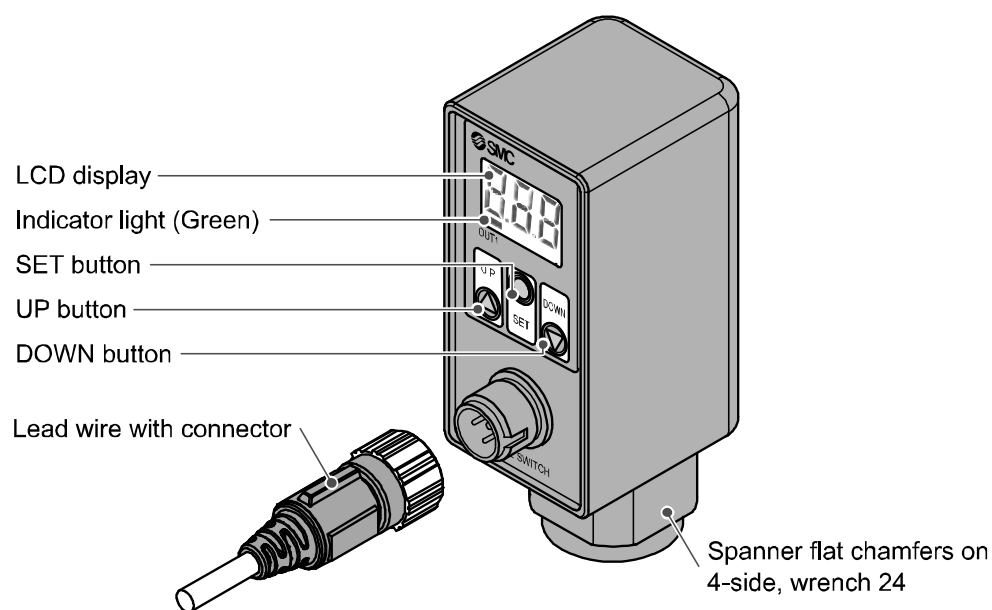

Indicator light (Green): Displays the operation condition of the Pressure switch. Lights ON when the output (OUT1) is turned ON.

LCD display: Displays the current status of pressure, setting mode and error code. Four display modes can be selected: display always in red or green only, or changing from green to red, red to green linked to output.

UP button: Increases the mode and ON/OFF set value.
Press this button to change to the peak display mode.

DOWN button: Decreases the mode and ON/OFF set value.
Press this button to change to the bottom display mode.

SET button: Press this button to change to another mode and to set a set value.

*: This picture applies to all output specifications except -27 and -67.

(If the output specification shown in a part number is -27 or -67, the indicator light OUT2 (Red) is added.)

■ Definition and terminology

	Terms	Meaning
7	7-segment indication	When "8" is shown on the display. It is called 7-segment because 8 consists of 7 pieces of "-" (segments)".
A	Accuracy	A value which shows what range the characteristics of the switch are within, against a certain standard. This means how accurate the switch is. The smaller this value, the more accurate the switch is.
B	Bottom value indication (mode)	Shows the minimum pressure reached at that moment.
C	Chattering	The phenomenon caused in the ON-OFF output type in which the output turns on and off repeatedly at high frequency.
	Condensation	A phenomenon where water vapor in the air turns to a liquid and adheres to a surface.
	Current consumption	The max. current necessary to operate the switch normally. Does not include load current.
D	Digit (min. setting unit)	Shows how precisely the pressure can be indicated or set by the digital Pressure switch. When 1 digit=1 kPa, the pressure is given with an increment of 1 kPa, e.g., 1, 2, 3, ..., 99, 100.
F	Fine adjustment mode	See "Fine adjustment of indicated value".
	F.S. (full span/full scale)	Abbreviation of full span or full scale which means the max. fluctuation range. For example, when the pressure range is 0 to 1[MPa], the F.S. will be 0-0=1[MPa]. (Reference: 1%F.S.=1×0.01=0.01[MPa])
H	Hysteresis	Difference between the points at which the Pressure switch is turned on and off.
I	Indicator light	A light that turns on when the ON-OFF output is on. (LED: light emitting diode)
	Insulation resistance	Insulation resistance of a product itself. The resistance between an electric circuit and a body.
K	Key lock (function)	Prohibits a change in the setting of the Pressure switch (locks button operation).
L	Load	An appliance connected to the output to do some kind of work. It includes relays, solenoid valves, etc.
	Load current	A current which flows to the load when the ON-OFF output is turned on.
	Load voltage	The voltage supplied to the load.
O	<ul style="list-style-type: none"> ●ON-OFF output ●Switch output 	<p>ON-OFF output is also referred to as switch output. Fig. 1 shows the equivalent circuit of an NPN switch with the output off. In this condition, the load is not powered, because there is no current flow. When the switch output is connected to a PLC, a high level of input signal is sent to the PLC.</p> <p>Fig. 2 shows the equivalent circuit of an NPN switch with the output on. In this condition, current flows and the load is powered. Also, the input signal sent to the PLC is low level. The PLC detects the change of input signal from high to low and can then proceed to the next process. These output types are called ON-OFF output or switch output. The point at which the output is switched can be changed freely within its setting range. The ON-OFF output can be PNP type as well as NPN type.</p> <div style="display: flex; flex-direction: column; align-items: flex-end;"> <p>Fig.1 Equivalent circuit with the NPN output off</p> <p>Fig.2 Equivalent circuit with the NPN output on</p> </div>

	Terms	Meaning
O	Open collector	A switch which outputs ON-OFF and whose output line or terminal is directly connected to the collector of output transistor.
	Operating humidity range	The humidity range in which the switch operates normally.
	Operating temperature range	The temperature range in which the switch operates normally.
P	Part in contact with fluid	A part which comes into contact with the measured gas (fluid).
	Peak value indication (mode)	Shows the maximum pressure reached at that moment.
	Piping-port size	The size of the port on the switch body with which a device and the switch are connected.
	Proof pressure	A pressure beyond which the Pressure switch breaks.
R	Rated pressure range	The detectable pressure range.
	R.D.	The value currently displayed. For example, when the displayed value is 1.000, $\pm 5\%$ R.D. will be ± 0.05 , which is $\pm 5\%$ of 1.000, while for a displayed value of 0.800 it will be 0.04.
	Repeatability	<p>Reproducibility of the displayed value for pressure and ON-OFF output operating point when the pressure changes at a temperature of 25 °C.</p> <p>Ex.) The switch for 100[kPa] is set to turn on at 50[kPa] or longer and its repeatability is ± 1.0[%F.S.]. F.S.=100-0=100[kPa] $\pm 1.0\%$F.S.=100\times0.01=± 1[kPa] This means the switch turns on at a pressure of 49 to 51[kPa] when the pressure is increasing. (Refer to the figure below.)</p> <p>Note: If the switch itself has a deviation of 1[%F.S.], it should turn on at 51[kPa], so taking repeatability into account it will actually turn on at a pressure of 50 to 52[kPa]. The same is true for the pressure display: a pressure in a range of 49 to 51[kPa] will be displayed as 50[kPa]. (Refer to the figure below.) This is when the Pressure switch itself originally has deviation. The smaller the repeatability, the better the reproducibility of the switch.</p> <p>The range where the output turns on when the set pressure is 50[kPa] and repeatability is ± 1.0[%F.S.]. It is not defined at which position the output turns on within this range.</p>
	Residual voltage	The difference between the ideal ON voltage and the actual voltage when the switch output is on. It depends on present load current and ideally should be "0".
Response time	The elapsed time until the ON-OFF output begins working since the pressure supplied for the Pressure switch has reached the set value.	

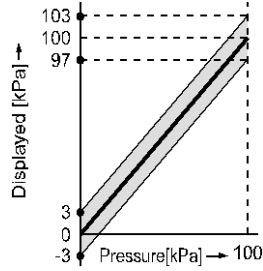
	Terms	Meaning
S	Set pressure resolution	A value which shows how precisely the set value of the switch can be set. If this value is 0.01 MPa, the set value will be 0.00, 0.01, 0.02, etc, and cannot be 0.015, 0.025, etc.
	SUS***	A symbol to classify the type of stainless steel.
T	Temperature characteristics	<p>The temperature characteristics show how much temperature affects the switch. We show the temperature characteristics for 0 to 50[°C] or -5 to 50[°C] based on data at 25[°C].</p> <p>Ex.) For a switch which has temperature characteristics of $\pm 3.0\%$[F.S.] and characteristics at 25[°C] as shown by the bold line in the figure on the left, the effect of temperature on the pressure display of the switch is calculated as follows, the figure on the left shows the example of the switch for 100[kPa], so</p> <p>F.S.=100-0=100[kPa] $\pm 3.0\%$F.S.=100\times0.03=± 3[kPa]</p> <p>Therefore, when the temperature changes in a range of 0 to 50[°C], there will be deviation of up to ± 3[kPa]. This is the max. value and so the actual deviation will be within the range enclosed by the thin line in the figure on the left.</p> 
U	Unit conversion function	Function to change the unit in which the value of pressure is indicated. Only a product with this function can change the unit. A product with unit-changing function cannot be purchased if it is used within Japan. Pressure is indicated only by SI units in Japan.
V	Voltage resistance	Durability to voltage applied between an electric circuit and a body. A product's durability in withstanding voltage. If more voltage is applied to the product, the product may be broken. (Voltage mentioned here is power voltage to activate the product.)
Z	Zero clear (function)	Adjusts the displayed pressure value to "0".

Mounting and Installation

■ Piping

○ Piping connection

- Connect the fitting to piping.
- When piping, tighten to an appropriate torque of 13.6 to 15 Nm for ISE70 series and 25 to 28 Nm for ISE75/75H series.

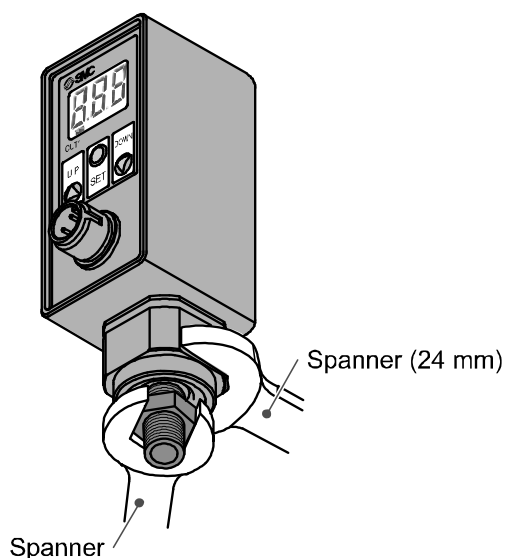

■ Installation

○ Mounting

- Install using a special bracket (Model: ZS-31-A) available as options.

○ Mounting by bracket

- Mount the fitting between the bracket assembly and bracket B.
- Then, mount it on the panel precisely by using M6 screws to prevent shrinkage and play.
- Reinforce the mounting by using nuts etc. for the panel with a thickness of 5 mm or less.

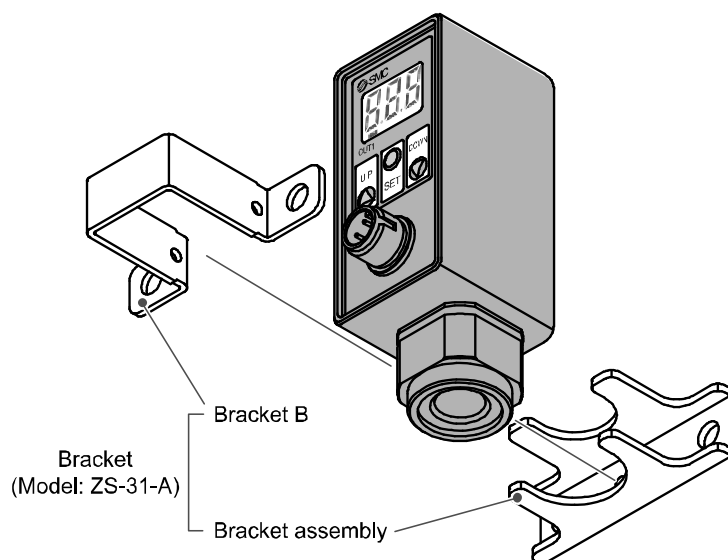

■Wiring

○Output specification

The colors of the wires are shown on the schematic (brown, white, blue, and black) apply to circuits where the SMC lead wire with connector is used.

The output specifications -27 and -67 have either NPN 2 outputs or PNP 2 outputs. Each output can have an independent pressure set value.

The output specification -43 has NPN open collector output and PNP open collector output. The NPN output and PNP output can operate with a single pressure setting value. Connect the wire of NPN or PNP output, whichever is necessary. The unnecessary output should remain unconnected.

-27

NPN open collector 2 outputs
Max. 30 V, 80 mA,
Residual voltage 1 V or less

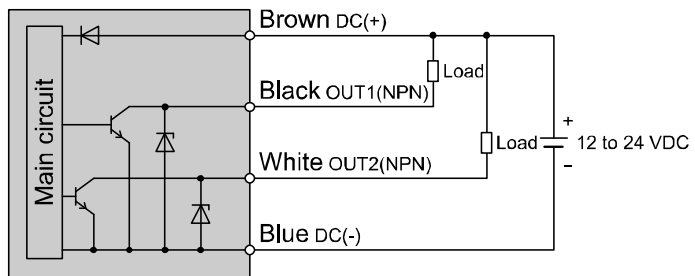

-43

NPN open collector 1 output
+
PNP open collector 1 output
Max. 30 V (NPN), 80 mA,
Residual voltage 1 V or less

A Pressure set value of switch output for NPN and PNP is common.

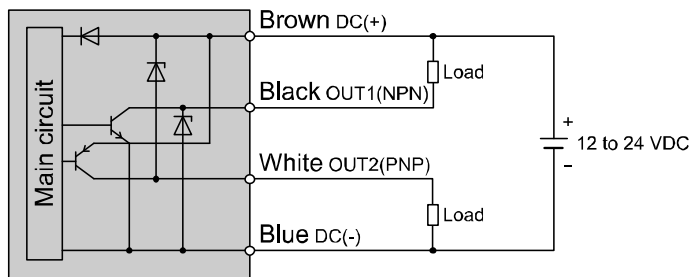

-65

PNP open collector 1 output
Max. 80 mA

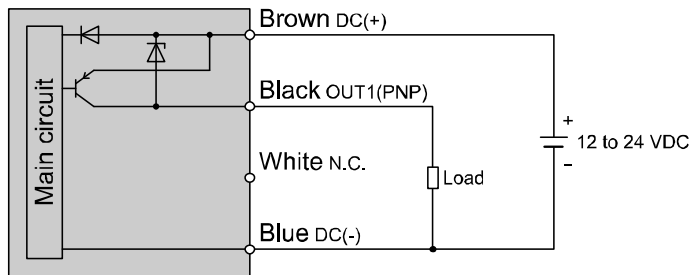

-67

PNP open collector 2 outputs
Max. 80 mA

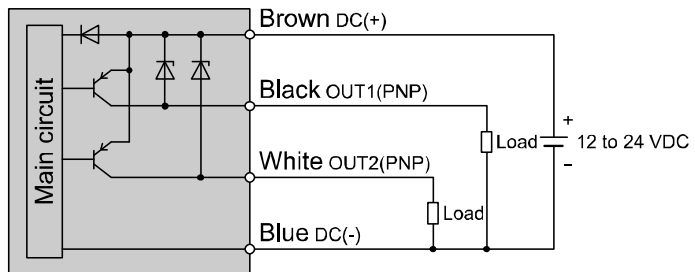

○Connection

- Connections should only be made with the power supply turned off.
- Use separate routes for the Pressure switch wiring and any power or high voltage wiring. Otherwise, malfunction may result due to noise.
- Ensure that the FG terminal is connected to ground when using a commercially available switch-mode power supply. When a switch-mode power supply is connected to the product, switching noise will be superimposed and the product specification can no longer be met. This can be prevented by inserting a noise filter, such as a line noise filter and ferrite core, between the switch-mode power supply and the product, or by using a series power supply instead of a switch-mode power supply.

○Connector Mounting/Removal

- Insert the lead wire with connector with reference to key grooves.
- Pinch the knurl with 2 fingers and tighten it rotating clockwise.

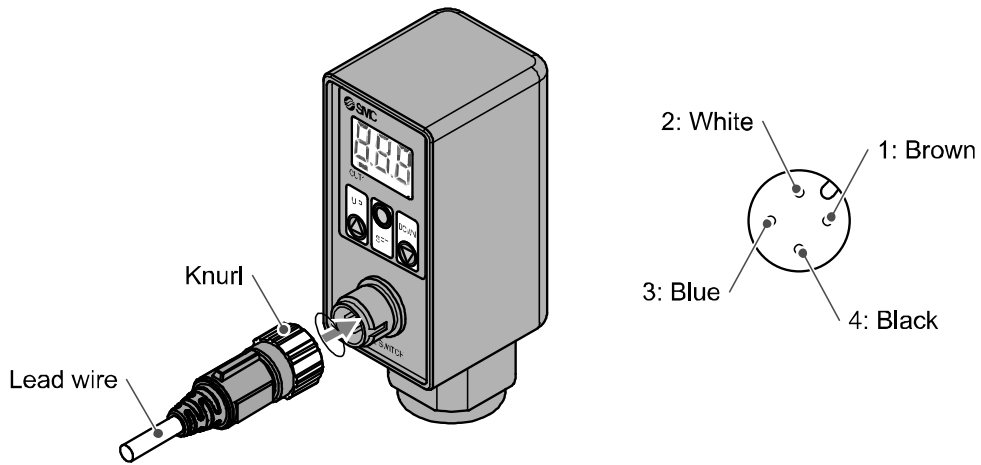

Output -43

1	Brown	DC(+)
2	White	OUT1(PNP)
3	Blue	DC(-)
4	Black	OUT1(NPN)

Output -65

1	Brown	DC(+)
2	White	NC
3	Blue	DC(-)
4	Black	OUT1(PNP)

Output -27/-67

1	Brown	DC(+)
2	White	OUT2 (NPN or PNP)
3	Blue	DC(-)
4	Black	OUT1 (NPN or PNP)

See the circuit diagram (page 15) and the above table for proper wiring.

Setting and Adjustment

■ Initializing

○ Setting procedures

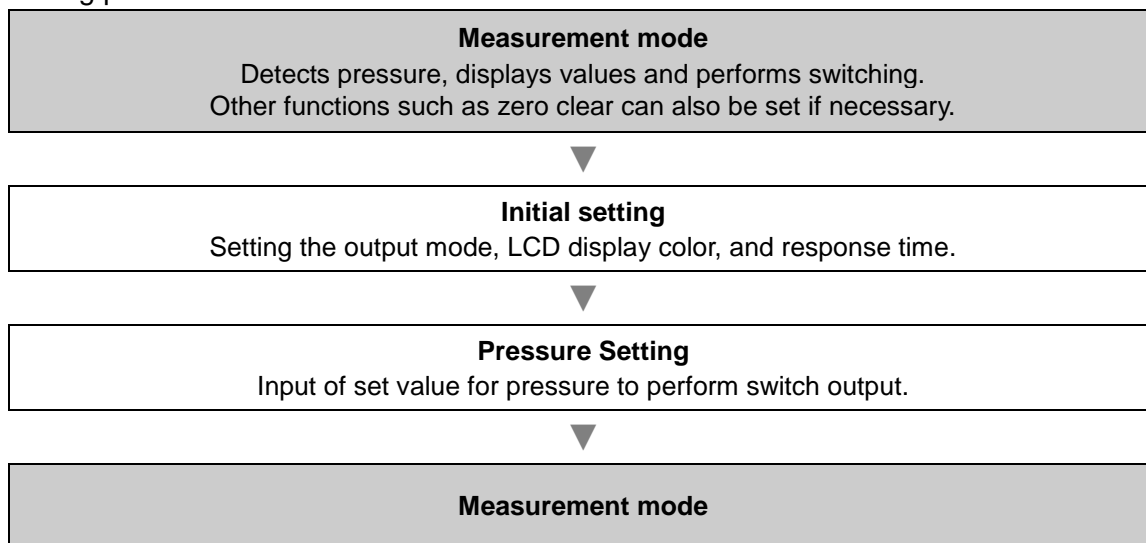

○ Initial setting

Press the SET button continuously for 2 seconds or longer.
The display shown at the right will appear to allow operating mode of initial setting.

Finish initialization and return to measurement mode by no operation for 30 seconds or keeping pressing the SET button for 2 seconds or longer during initialization.

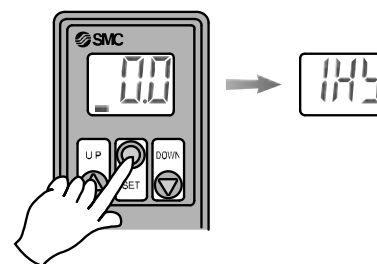

1. Output mode setting

There are 4 types of output modes due to the combination of the operation mode and the output style. One output mode from the four can be selected for each output.

1) The operation mode for OUT1 can be selected.

The operation mode currently selected will be displayed.

Select a desired operation mode by pressing the UP or DOWN button.

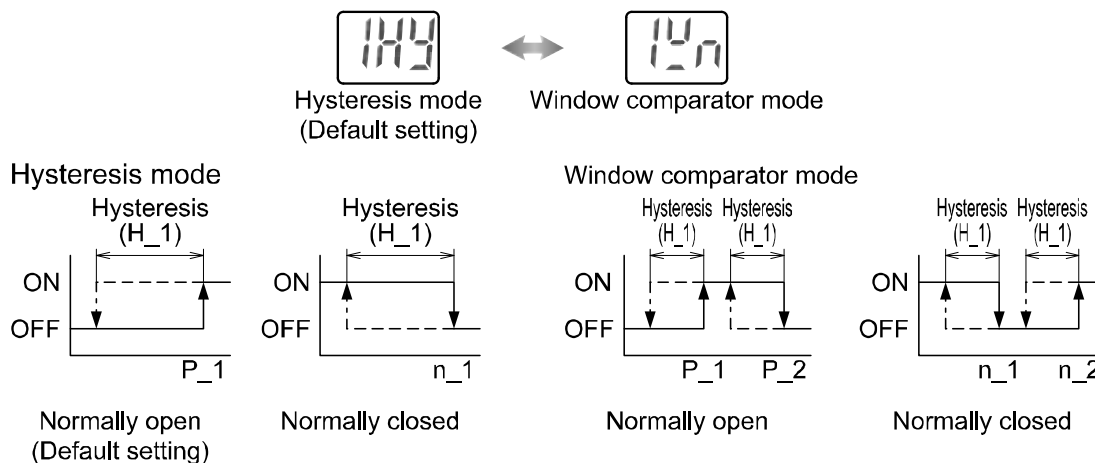

Press the SET button to set the selected operation mode, and the output style of OUT1 option will appear.

- 2) The output style of OUT1 can be selected.
 The output style currently selected will appear.
 Select a desired operation mode by pressing the UP or DOWN button.

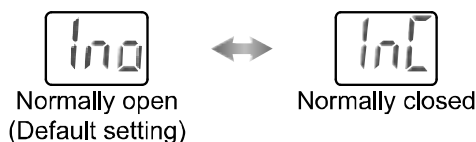

Press the SET button to set the output style.
 For output specifications -43 and -65, set the options.
 For output specifications -27 and -67, set the operation mode of OUT2.

- 3) Set the operation mode of OUT2 simultaneously with that of OUT1.
 (Only for the output specifications -27 and -67)

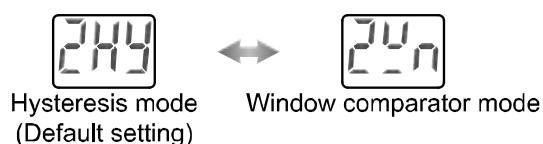

Press the SET button to set the operation mode, and the output style of OUT2 option will appear.

- 4) Set the operation style of OUT2 simultaneously with that of OUT1.
 (Only for the output specifications -27 and -67)

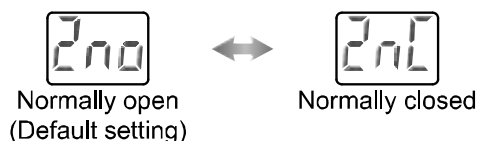

Press the SET button to set the operation style, and the options will appear.

2. Option setting (display unit, display color, response time)

Needed options can be selected.
 When they are selected, their current settings will appear.
 Select if option setting is needed by pressing the UP or DOWN button.

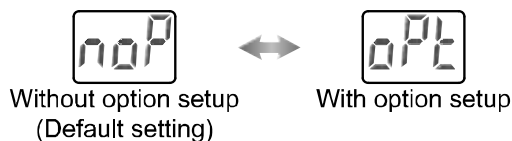

Press the SET button to set.

When the option is not needed, move to the setting of the operation mode of OUT1.
 To finish the setting at this stage, press the SET button for 2 seconds or longer to return to measurement mode.

When the option is needed and selected, the setting of display unit will appear.

It is possible to return to measurement mode from any option setting by pressing the SET button for 2 seconds or longer.

If the selected unit in a part number is M, it is fixed to SI unit, and the setting of display color will appear.

3. Selection of display unit (for unit conversion function)

The units shown can be selected.

The currently selected unit will appear.

Pressing the UP or DOWN button will change the unit and will automatically convert set values.

The units will change in the following order: PA ↔ GF ↔ bAr ↔ PSi

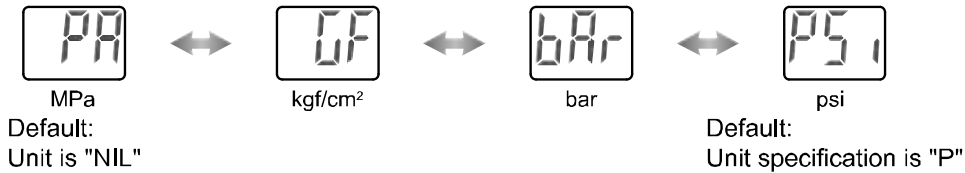

Press the SET button to set and move to the display color setting.

Resolution of each units

Setting and display resolution	ISE70	ISE75(H)
MPa	0.01	0.1
kgf/cm ²	0.1	1
bar	0.1	1
psi	1	1 (×10)

Caution

If the indication units are changed, the set value and hysteresis should be set again.

4. Display color setting

The color of LCD can be selected.

The currently selected color will appear.

Select the color by pressing the UP or DOWN button.

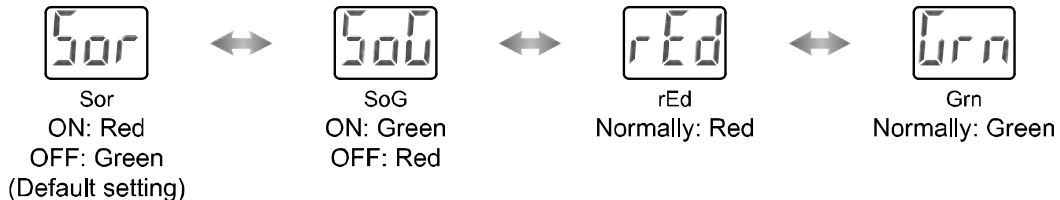

Press the SET button to set the selected color of the LCD.

For the output specifications -43 and -65, the setting response time will appear.

For the output specification -27 and -67, the setting of the output for the LCD color when either Sor or SoG appears.

For other output specifications, the setting of response time will appear.

5. Setting of output for LCD color

(Only when the selected LCD color is Sor or SoG with the output specifications -27 or -67)

The output for the LCD can be selected.

The current output for the LCD color will appear.

Press either of the UP or DOWN button to select the output and LCD color simultaneously, and press the SET button.

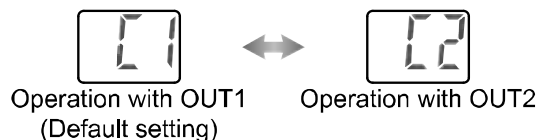

Press the SET button to move to the setting of response time.

6. Response time setting

The response time of the switch output can be selected.

Setting of a response time prevents chattering in output.

The response time currently selected will appear.

Select a desired response time by pressing the UP or DOWN button.

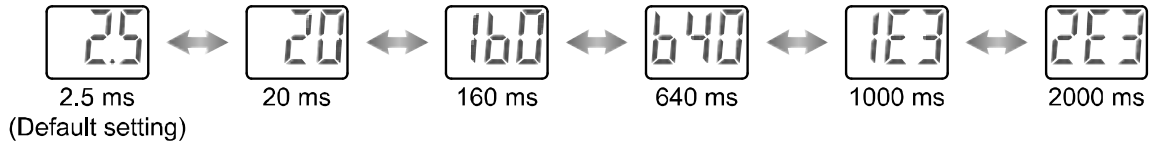

For the ISE70 series, set the selected response time by pressing the SET button, and returns to the select operation mode of OUT1 function.

For the ISE75/ISE75H series, press the SET button to fix the setting and move to the setting of the zero-cut function.

7. Zero-cut function setting (for ISE75/ISE75H Series)

The function to show zero for pressure ranges of 0.3MPa or less for ISE75 series and of 0.4MPa or less for ISE75H series (zero-cut function) can be selected.

The current setting of the zero-cut function will appear.

Press the UP or DOWN button to add or exclude the zero-cut function.

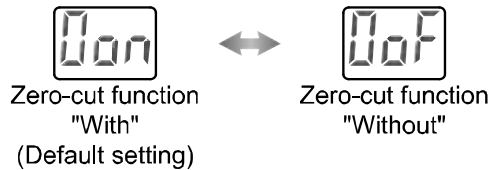

- Example of displayed pressure (The shaded parts are different.)

ISE75-* (for 10 MPa)

With zero-cut function: 0 → **0 displayed** → 0.4 → 0.5 → 0.6 → •• → 9.9 → 10.0

Without zero-cut function: 0 → **0.1 → 0.2 → 0.3** → 0.4 → 0.5 → 0.6 → •• → 9.9 → 10.0

ISE75H-* (for 15 MPa)

With zero-cut function: 0 → **0 displayed** → 0.5 → 0.6 → •• → 14.9 → 15.0

Without zero-cut function: 0 → **0.1 → 0.2 → 0.3 → 0.4** → 0.5 → 0.6 → •• → 14.9 → 15.0

Pressure indicated range

	Zero-cut function "With"	Zero-cut function "Without"
ISE75	0, 0.4 to 10.0 MPa	0 to 10.0 MPa
ISE75H	0, 0.5 to 15.0 MPa	0 to 15.0 MPa

*: Even without the zero-cut function, the set pressure range will not be changed.

Press the SET button to set the selection, and return to the select operation mode of OUT1.

8. Completion of initial setting

After all settings are completed, press the SET button for 2 seconds or longer to return to measurement mode.

It is possible to return to measurement mode from any setting item by pressing the SET button for 2 seconds or longer.

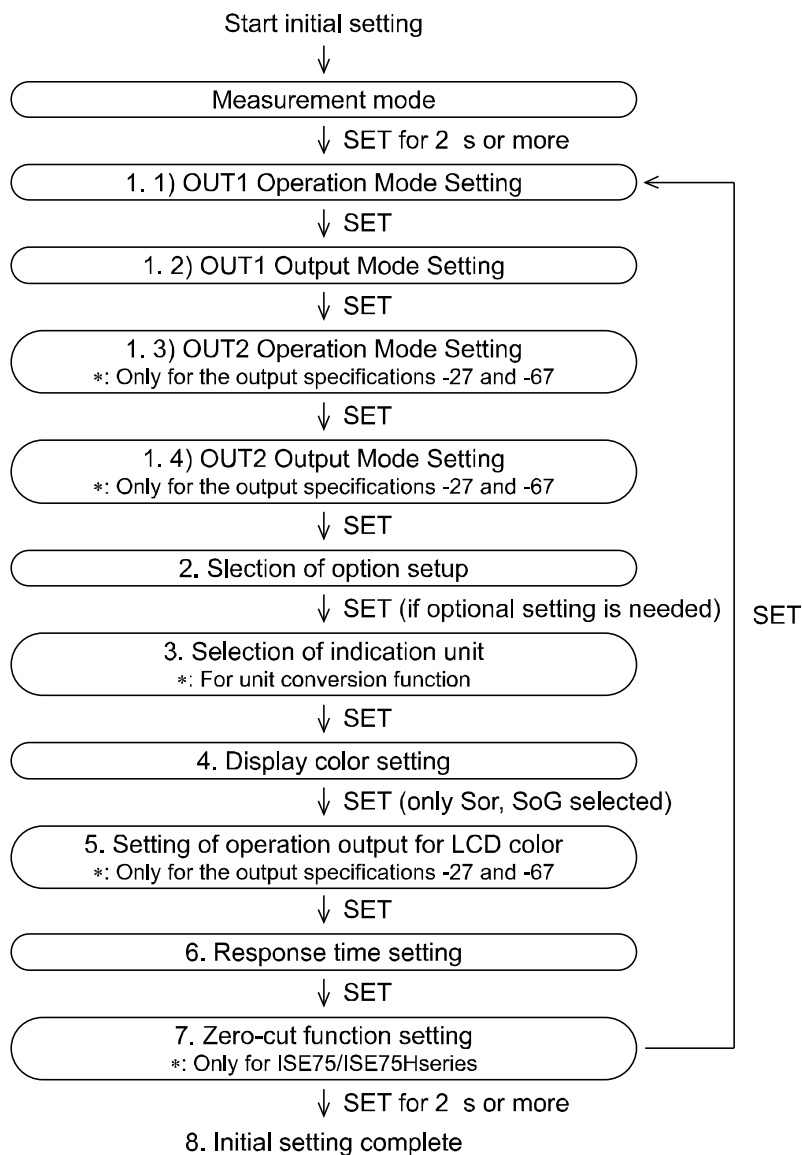

■ Pressure setting

○ Pressure input mode for OUT1

Press the SET button in measurement mode to display set values. [P_1] or [n_1] and the current set value will flash in turn. Press the SET button to display the next set value (Hysteresis: H_1). Press the UP or DOWN button to enter the value change mode. (See "Value setting" page 23)

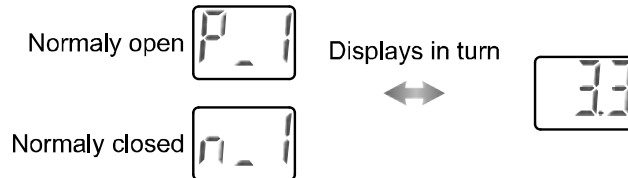

○ When hysteresis mode is set

If the hysteresis mode is set, [H_1] and the set value of hysteresis will appear in turn after the setting for [P_1] or [n_1]. Press the SET button to return to normal measurement mode. Press the UP or DOWN button to enter the value change mode. (See "Value setting": page 23)

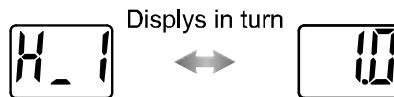

Normally open mode

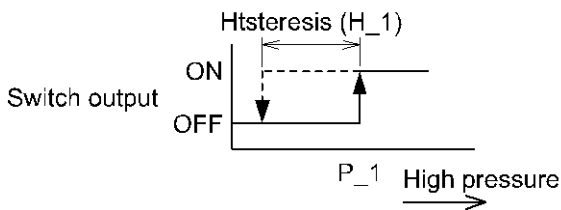

Normally closed mode

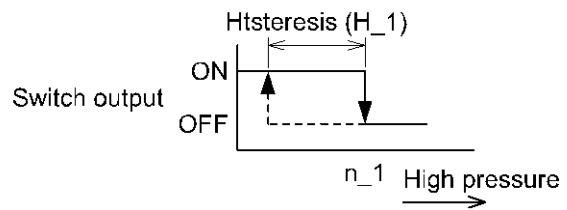

In case hysteresis is set to 2 digits or less, switch output may chatter if input pressure fluctuates near the set value.

○When window comparator mode is set

If the Window comparator mode is set, [P_2] or [n_2] and the current set value will appear in turn after the setting for [P_1] or [n_1]. Press the SET button to display the next set value. (Hysteresis: H_1)
 Press the UP or DOWN button to enter the value change mode.
 Next, [H_1] and the set value of Hysteresis will appear in turn. Press the SET button to return to measurement mode. Press the UP or DOWN button to enter the value change mode.
 (See "Value setting")

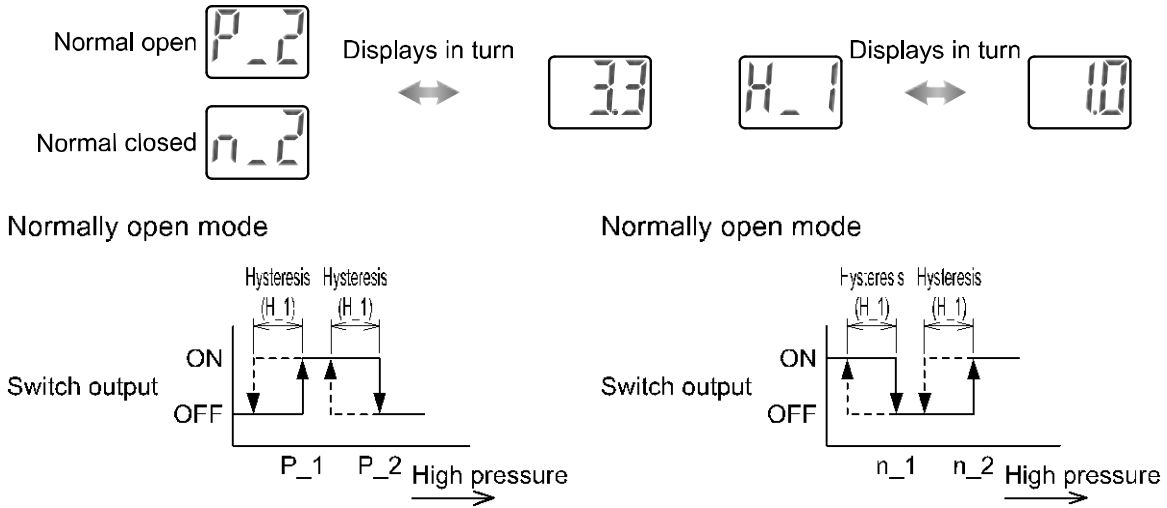

If the initialized value is normally open mode, [P_1] will appear, and [n_1] will appear if it is normally closed mode. The set pressure can be checked without holding or stopping switch output operation.

○Pressure input mode for OUT2 (for output specifications -27 and -67)

Set a value for [P_3], [P_4] and [H_2] same as that for OUT1. [P_3], [P_4] ([n_3] or [n_4] for normally closed mode) and [H_2] and the current set values for them flash in turn.

Value setting

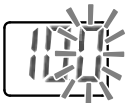

To input a value for pressure setting or other purposes:

1. Press the UP or DOWN button to enter the set value change mode. The first digit will flash.
2. Press the UP or DOWN button to set a desired value. (No operation for 30 seconds after the set value change mode was selected results in automatic setting of the value appearing in the display, and set value indication returns.)
3. Press the SET button to move to the left digit. The 2nd digit will flash. (In the case that the SET button is pressed at the left end digit, the 1st digit will flash.)
4. Press the SET button continuously for 1 second or longer to return to the set values.

1st digit 

2nd digit 

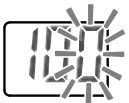
3rd digit 

■ Setting of function

○ Fine adjustment mode (Fine adjustment function of display value)

Press the SET and DOWN buttons simultaneously for 2 seconds or longer in measurement mode. [FSt] and current set value will appear. Press the UP or DOWN button to change the set value (possible to increase or decrease to $\pm 5\%R.D.$). If no operation is made for 2 seconds or longer or the SET button is pressed, the current set value will return. Press the SET button to display an adjusted amount (percentage), which will then flash in turn with [FSC]. Press the SET button to return to measurement mode.

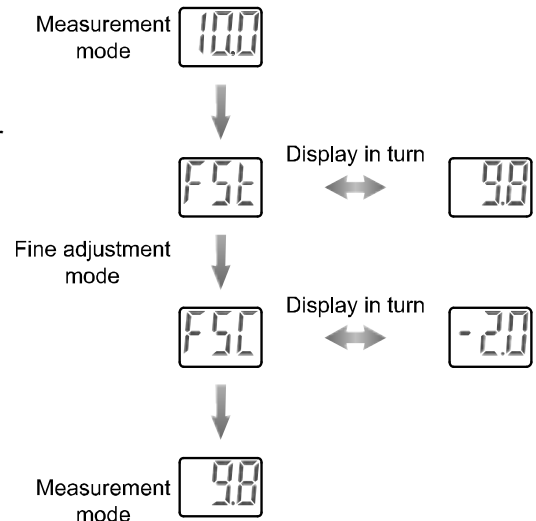

The deviation of each output is compensated, which results in a consistent displayed value. It is possible to increase or decrease the displayed pressure to $\pm 5\%R.D.$

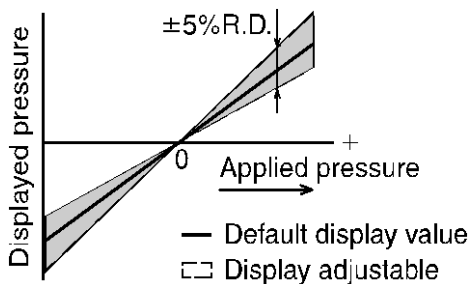

*: If the displayed pressure is adjusted, the pressure can change by ± 1 digit.

○ Peak and Bottom hold display function

Maximum and minimum values are always detected and updated during measurement, and displayed values can be held. In peak hold, press the UP button for 1 second or longer to make the display flash and to hold the maximum pressure value.

To reset holding, press the UP button again for 1 second or longer to return to measurement mode. In bottom hold, press the DOWN button for 1 second or longer to make the display flash and to hold the minimum pressure value. To reset holding, press the DOWN button again for 1 second or longer to return to measurement mode.

Maximum pressure value or minimum pressure value can be initialized by pressing UP and DOWN buttons for 1 second or longer simultaneously during the hold display.

○ Key lock function

A wrong operation performed unintentionally such as the change of set value can be prevented. Press the SET button for 4 seconds or longer to display either of [LoC] or [UnL] currently set.

Select by pressing the UP or DOWN button and set by pressing the SET button. If button operation needs to be locked, set to [LoC] to set the lock mode. To release key lock, press the SET button for 4 seconds or longer to display the current setting and set to [UnL].

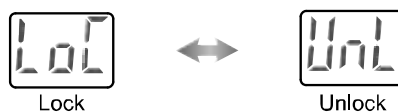

○Zero Clear Function

A displayed value can be adjusted to zero when the pressure to be measured is within $\pm 7\%$ F.S. of the pressure at the time of shipment from the factory.

(The range of ± 1 digit setting is different depending on the individual product difference)

Press continuously the UP and DOWN buttons for 1 second or longer simultaneously the display will be cleared as "0" and measurement mode will automatically return.

Maintenance

How to reset the product after power cut or forcible de-energizing

The setting of the product will be remained as it was before power cut or de-energizing.

The output condition is also basically recovered to that before power cut or de-energizing, but may change depending on the operating environment.

Therefore, check the safety of whole facility before operating the product.

If the facility is under accurate control, wait until it has warmed up. (20 to 30 minutes)

Troubleshooting

○ Troubleshooting

Applicable Pressure switch: ISE70/ISE75(H)

If a cause applicable to the failure cannot be identified and normal operation can be recovered by replacement with a new Pressure switch, this indicates that the Pressure switch itself was broken. The Pressure switch breakage can be caused by operating environment (network construction, etc.), and so consult with SMC separately to obtain countermeasures.

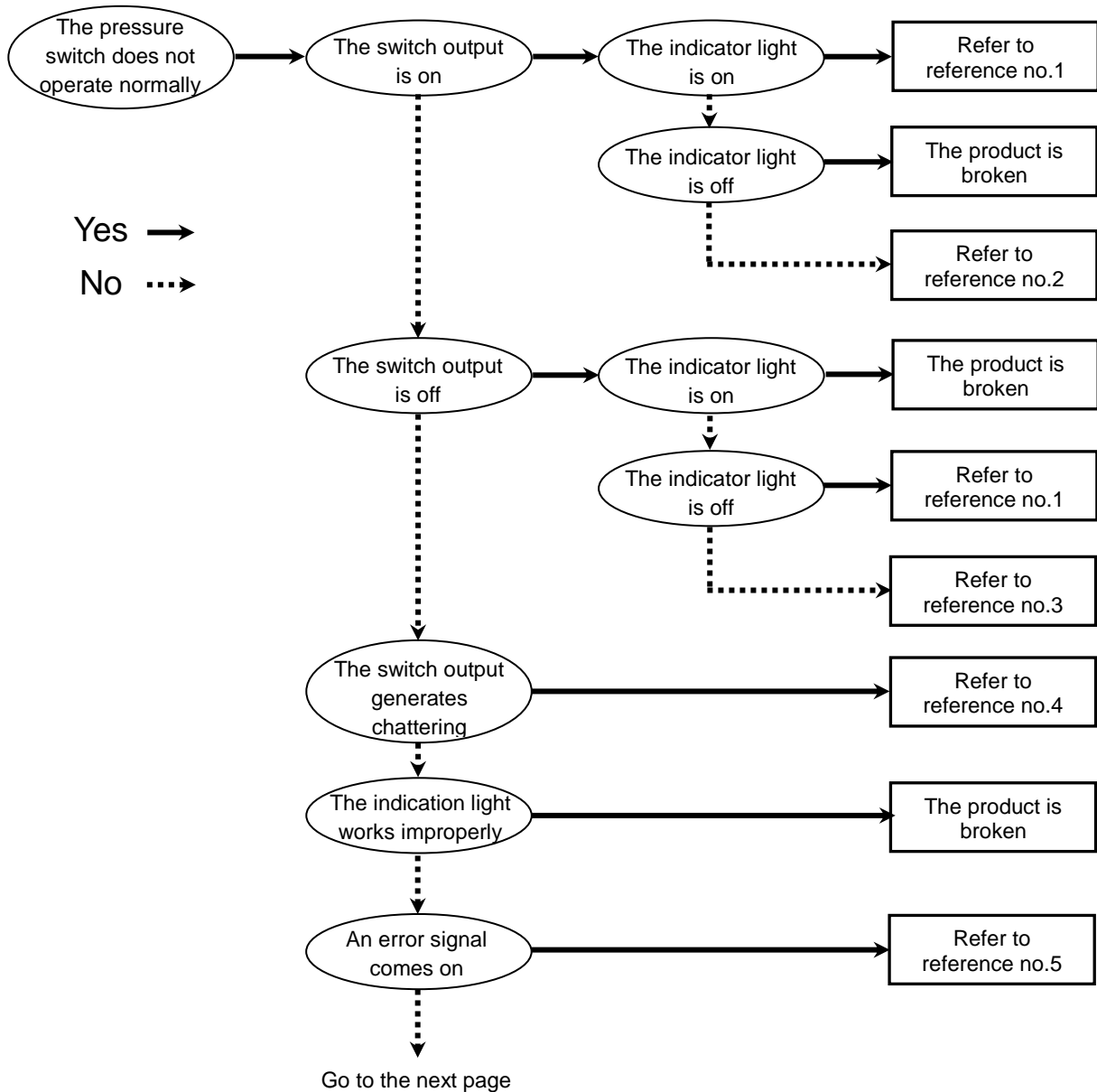

Continued from the previous page.

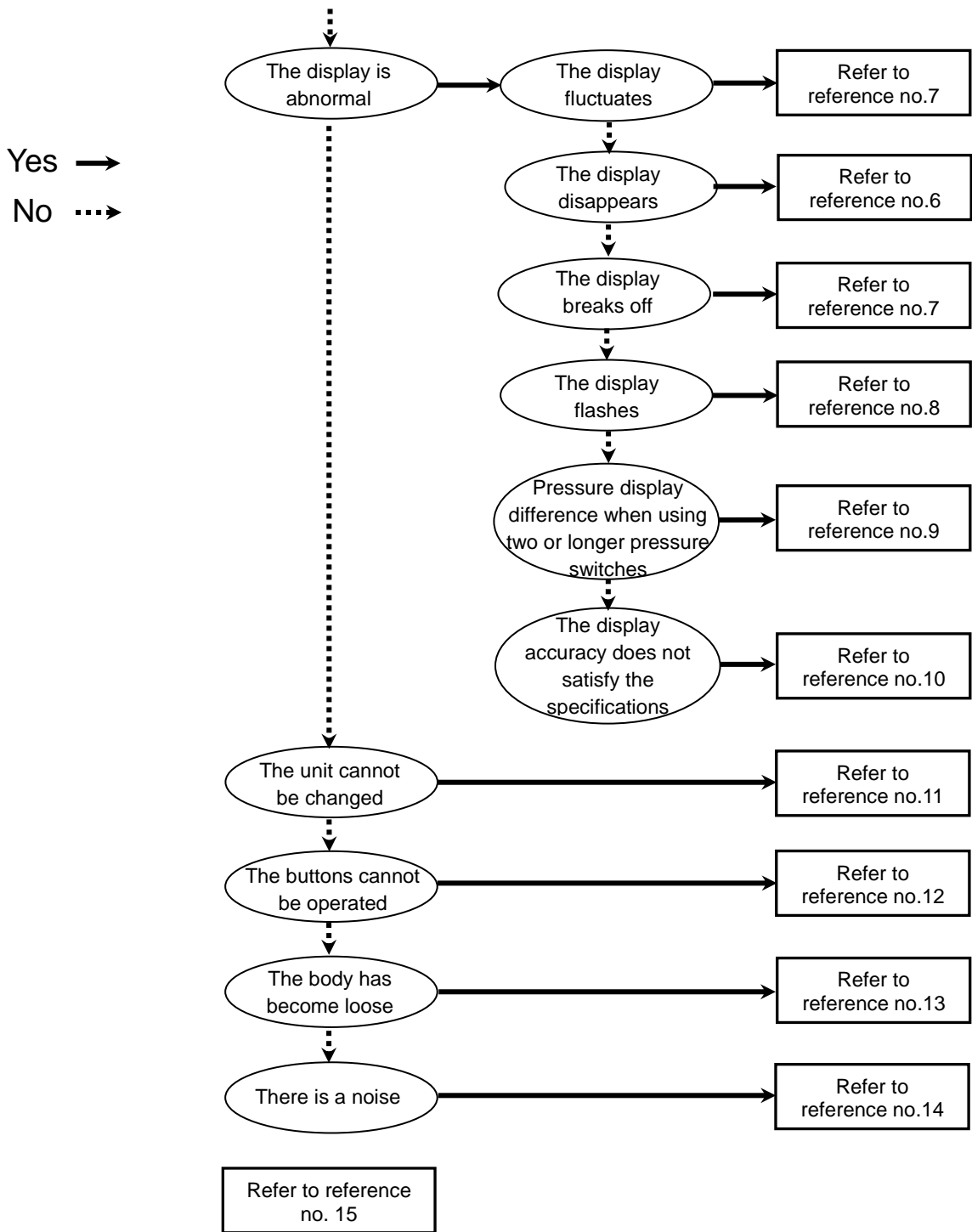

○Cross-reference for troubleshooting

Reference No.	Problem	Possible cause	Investigation method	Countermeasure
1	<ul style="list-style-type: none"> ●Output remains on. Indicator light remains on. ●Output remains off. Indicator light remains off. 	Wrong pressure setting	(1) Check the set pressure. (2) Check the initial settings of the operation mode and output style. (Hysteresis mode/window comparator mode, normally open mode/normally closed mode)	(1) Reset the pressure. (2) Reset the initial setting.
		Product failure		Replace the product.
2	Output remains on. Indicator light works correctly.	Incorrect wiring	Check the wiring of the output line. Check if the load is connected directly to DC(+) or DC(-).	Correct the wiring.
		Product failure		Replace the product.
3	Output remains off. Indicator light works correctly.	Incorrect wiring	Check the wiring of the output line. Check if the load is connected directly to DC(+) or DC(-).	Correct the wiring.
		Unsuitable model selection	Check if PNP is used even though NPN should have been selected, or the other way around.	Review the selected model (output type).
		Lead wire breakage	Check if there is bending stress applied to any parts of the lead wire. (Bending radius and tensile force applied to the lead wire)	Correct the wiring conditions. (Adjust the tensile force and widen the bending radius.)
		Product failure		Replace the product.
4	Switch output generates chattering.	Incorrect wiring	Check the wiring. Check if the brown and blue wires are connected to DC(+) and DC(-) respectively, and if the output line is about to come off (contact failure).	Correct the wiring.
		Wrong setting	(1) Check the set pressure. Check if the hysteresis range is too narrow. (2) Check the initial setting of response time. Check that the response time is not too short.	(1) Reset the pressure. Widen the hysteresis. (2) Reset the initial setting.
		Product failure		Replace the product.

Reference No.	Problem	Possible cause	Investigation method	Countermeasure
5	<ul style="list-style-type: none"> •An over current error (Er1, 2) is indicated. •System error (Er4, 6, 7, 8) is indicated. •The display shows "HHH". •The display shows "LLL". •Residual pressure error (Er3) is indicated. 	Over current to the output (Er1, 2)	<ul style="list-style-type: none"> (1) Check if a current of 80mA or longer is flowing to the output. (2) Check if the connected load satisfies the specifications, and if the load is shorted. (3) Check if a relay without a surge voltage suppressor is connected. (4) Check if the wiring is in the same route as (or bundled together with) a high-voltage line or the power line. 	<ul style="list-style-type: none"> (1), (2) Connect the load as specified. (3) Use a relay with a surge voltage suppressor or take a measure to prevent noise. (4) Separate the wiring from the high-voltage line and/or power line.
		Improper transaction of the internal data of the pressure switch (Er4, 6, 7, 8)	<ul style="list-style-type: none"> (1) Check if there is noise interference such as static electricity. Check if there is a noise source (2) Check that the operating voltage is not less than 12 VDC. 	<ul style="list-style-type: none"> (1) Remove the noise and the noise source (or take measures to prevent noise interference), and reset the product or turn off the power supply. Then, supply the power again. (2) Supply operating voltage of 12 to 24 VDC (ripple $\pm 10\%$).
		Applied pressure is over the upper limit (HHH).	<ul style="list-style-type: none"> (1) Check if the pressure gets over the upper limit of the set pressure range. (2) Check whether moisture such as water droplets has got into the piping. (ISE70 series only) 	<ul style="list-style-type: none"> (1) Bring the pressure back within the set pressure range. (2) Take measures to prevent foreign matter from getting into the piping.
		Applied pressure is under the lower limit (LLL).	<ul style="list-style-type: none"> (1) Check if the pressure gets below the lower limit of the set pressure range. (2) Check whether moisture such as water droplets has got into the piping. (ISE70 series only) 	<ul style="list-style-type: none"> (1) Bring the pressure back within the set pressure range. (2) Take measures to prevent moisture from getting into the piping.

Reference No.	Problem	Possible cause	Investigation method	Countermeasure
6	Displayed values fluctuate.	Incorrect power supply	Check if the power supply voltage is within the range of 12 to 24 VDC. (ripple $\pm 10\%$)	Supply power supply voltage of 12 to 24 VDC (ripple $\pm 10\%$)
		Incorrect wiring	Check the wiring to the power supply. Check if the brown and blue wires are connected to DC(+) and DC(-) respectively and if the output line is about to come off (contact failure).	Correct the wiring.
7	<ul style="list-style-type: none"> •Indicator light turns off. •A part of the indication misses. 	Incorrect power supply	Check if the power supply voltage is within the range of 12 to 24VDC. (ripple $\pm 10\%$)	Supply power supply voltage of 12 to 24VDC (ripple $\pm 10\%$)
		Incorrect wiring	Check the power supply wiring. Check if the brown and blue wires are connected to DC(+) and DC(-) respectively and if the output line is about to come off (contact failure).	Correct the wiring.
		Product failure		Replace the product.
8	Indicator light is blinking.	The peak value/bottom value display mode is selected.	Check if the peek value or bottom value indicating mode is selected.	Turn off the peak value/bottom value indication mode.
		Wiring failure	(1) Check the power supply wiring. (2) Check if bending stress is being applied to a specific part of the lead wire.	(1) Correct the wiring. (2) Correct the wiring (bending radius and stress).
9	Pressure display difference when using two or longer pressure switches.	Dispersion within the display accuracy range	Check if the dispersion is within the display accuracy range.	Use the fine adjustment mode to adjust the display if the dispersion is within the indication accuracy range.
		Product failure		Replace the product.

Reference No.	Problem	Possible cause	Investigation method	Countermeasure
10	The pressure display accuracy does not satisfy the specifications.	Foreign matter	Check if foreign matter has entered the pressure port.	Install a filter (strainer) to prevent foreign matter from getting into the pressure port. Also, clean the filter (strainer) regularly to prevent drainage deposits.
		Air and liquid leakage	Check if air and liquid are leaking from the piping.	Rework the piping. If excessive tightening torque over the specified range is applied, a mounting screw, mounting bracket, and switch may be broken.
		Insufficient warm-up	Check if the product satisfies the specified accuracy 20 min. after supplying power.	After the power supply is turned on, display and output can drift. For detecting fine pressure, warm up the switch for 20 to 30 min.
		Product failure		Replace the product.
11	The unit cannot be changed.	Improper model selection (Selection of model "without unit conversion function")	Check whether there is a "-M" at the end of the part number on the name plate	"M" in a part number means that the unit cannot be changed. (1) The unit conversion function is not available in Japan due to a new measurement law. (2) It is fixed to the SI unit "kPa" and "MPa".
12	The buttons cannot be operated.	Key lock mode	Check if the key lock mode is turned on.	Turn off the key lock mode.
		Product failure		Replace the product.
13	The body is loose.	Incorrect installation	Check that the bracket and the switch body are firmly engaged.	Mount the switch body on the bracket properly.
		Product failure		Replace the product.

Reference No.	Problem	Possible cause	Investigation method	Countermeasure
14	Noisy.	Air and liquid leakage	Check if air liquid are leaking from the piping.	Rework the piping. If excessive tightening torque over the specified range is applied, a mounting screw, mounting bracket, and switch may be broken.
		Product failure		Replace the product.
15	The operation is unstable. (Chattering)	Effect of pressure source fluctuations, due to hysteresis being too small or response time being too fast.	(1) Check the set pressure (hysteresis) (2) Check the response time	(1) Check the pressure setting. (2) Reset the initial setting and pressure setting.
		Incorrect wiring breakage	Check the connection at the connected parts (connector contact pin and crimped terminal).	Correct the wiring.
		Lead wire breakage	Check if bending stress is applied to a specific part of the lead wire. (bending radius and tensile force applied to the lead wire)	Correct the wiring conditions. (Adjust the tensile force and widen the bending radius.)

○Error indication function

This function is to display error location and content when a problem or an error occurs.

Error Name		Error Display	Error Type	Troubleshooting Method
Over current Error	OUT1	Er1	A load current of switch output is 80 mA or more.	Turn the power off and remove the output factor for the over current. Then turn the power on.
	OUT2 *	Er2		
Residual Pressure Error		Er3	During zero clear operation, pressure over $\pm 7\%$ F.S. is applied. After 3 s, the mode will reset to the measurement mode. ± 1 digit of the zero clear range varies with individual product differences.	Perform zero clear operation again after restoring the applied pressure to an atmospheric pressure condition.
Pressurizing Error		HHH	Pressure has exceeded the upper limit of the set pressure range.	Reset applied pressure to a level within the set pressure range.
		LLL	Pressure has exceeded the lower limit of the set pressure range.	
System Error		Er4 Er6 Er7 Er8	Displayed in the case of an internal data error.	Turn the power off and turn it on again. If resetting fails, an investigation by SMC CORPORATION will be required.

If the error can not be reset after the above measures are taken, then please contact SMC.

*: Only for the output specifications -27 and -67.

Specification

■ Specifications

Model No.	ISE70 (Air)	ISE75 (Fluid)	ISE75H (Fluid)	
Rated pressure range	0 to 1 MPa	0 to 10 MPa	0 to 15 MPa	
Set pressure range	-0.1 to 1 MPa	0.4 to 10 MPa	0.5 to 15 MPa	
Withstand pressure	1.5 MPa	30 MPa	45 MPa	
Set pressure resolution	0.01 MPa	0.1 MPa		
Fluid	Air, inert gas and incombustible gas	Fluid which has no corrosive effect on SUS304, SUS430, SUS630		
Power supply voltage	12 to 24 VDC $\pm 10\%$, ripple (p-p) 10% or less (Protected against inverse connection)			
Current consumption	55 mA or less (With no load)			
Switch output	Output -27: 2 set-ups, NPN open collector, 2 outputs (pin no.: 2 and 4) Output -43: 1 set-up, NPN open collector, 1 output (pin no.: 4) + PNP open collector, 1 output (pin no.: 2) *1 Output -65: PNP open collector, 1 output (pin no.: 4) Output -67: 2 set-ups, PNP open collector, 2 outputs (pin no.: 2 and 4)			
	Max. load current	80 mA		
	Max. impressed voltage	30 V (NPN output)		
	Residual voltage	1 V or less (80 mA load current)		
	Response time	2.5 ms (Chattering-proof function working: 20 ms, 160 ms, 640 ms, 1000 ms, 2000 ms selectable)		
	Short circuit protection	Provided		
Repeatability	$\pm 0.5\%$ F.S.			
Hysteresis	Hysteresis mode	Variable (From 0)		
	Window comparator mode			
Display method	3 digits 7-segment dual-color display (Red/Green) Display color can be linked with switch output			
Display accuracy	$\pm 2\%$ F.S., ± 1 digit (25 ± 3 °C)			
Indicator lamp	OUT1: Lit when ON (Green) OUT2: Lit when ON (Red: For output -27, -67)			
Function	Anti-chattering function, For display unit conversion function, Zero clear function, Key lock function			
Environment	Enclosure	IP67 *2		
	Medium temperature	0 to 50 °C (No condensation, No freezing)	-5 to 80 °C (No condensation, No freezing)	
	Ambient temperature	Operation: 0 to 50 °C Storage: -10 to 60 °C (No condensation, No freezing)	Operation: -5 to 50 °C Storage: -10 to 60 °C (No condensation, No freezing)	
	Ambient humidity	Operation, Storage: 35 to 85%RH (No condensation)		
	Withstand voltage	1000 VAC, 1 min. (Between lead block and case)	250 VAC, 1 min. (Between lead block and case)	
	Insulation resistance	50 M Ω or longer (at 500 VDC) (Between lead block and case)	50 M Ω or longer (at 50 VDC) (Between lead block and case)	

*1: The NPN and PNP outputs function for a single set point.

*2: The seal of the switch body uses a gasket made of FKM. For details, refer to "Safety Instructions".

Model No.	ISE70 (Air)	ISE75 (Fluid)	ISE75H (Fluid)
Temperature characteristic (25 °C reference: Within operating temperature range)	±2%F.S.	±3%F.S.	
Standard	CE, UL/CSA, RoHS		
Material for Fluid connect	Pipe port: C3604 (electro less nickel plating) Sensor port: PBT Sensor pressure sensing pat: silicone O-ring: NBR	Pressure sensing pat: SUS630 Pipe port: SUS304 (Port size Rc1/4) Pressure sensing pat: SUS630 Pipe port: SUS430 (Port size NPT1/4, G1/4)	
Port size	02: Rc1/4, N02: NPT1/4, F02: G1/4 (ISO1179) *3		
Lead wire	M12 oil resistant cable with a 4 pin pre-wired connector 4 cores φ4, 5 m Conductor outside diameter: 0.72 mm Insulator outside diameter: 1.14 mm		
Weight	190 g (Excluding lead wire with M12 4-pin pre wired connector)	225 g (Port size Rc1/4) 210 g (Port size NPT1/4, G1/4) (Excluding lead wire with M12 4-pin pre wired connector)	

*3: G1/4: applicable to ISO1179-1

■Dimensions

•Dimensions of main unit

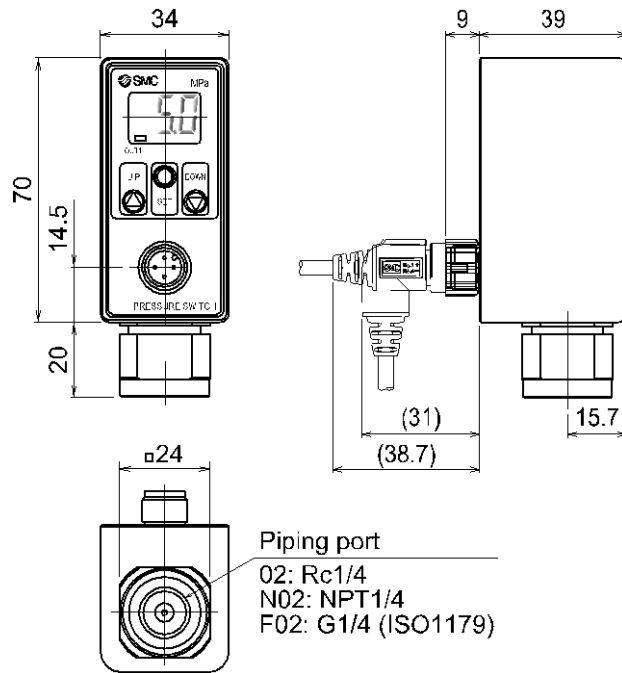

•Bracket supplied

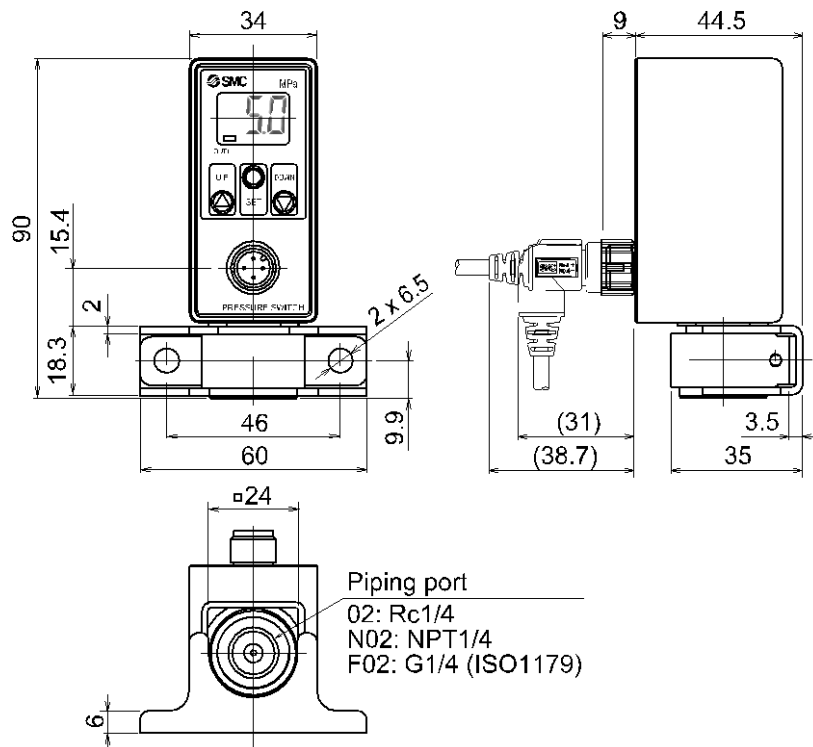

Revision history

B: Correction of miswriting and creation of new drawing due to format change
C: Revision
D: Contents revised in several places.
E: Contents revised in several places.
F: Contents revised in several places. [July 2018]

SMC Corporation

4-14-1, Sotokanda, Chiyoda-ku, Tokyo 101-0021 JAPAN

Tel: + 81 3 5207 8249 Fax: +81 3 5298 5362

URL <http://www.smcworld.com>

Note: Specifications are subject to change without prior notice and any obligation on the part of the manufacturer.

© 2007-2018 SMC Corporation All Rights Reserved

