



# Operation Manual

PRODUCT NAME

Digital Pressure Switch

MODEL / Series / Product Number

*ISE35*

**SMC Corporation**

## Table of Contents

Safety Instructions	2
Model Identification and How to Order	8
Summary of Product parts	9
Mounting and Installation	10
Wiring	10
Pressure Setting	11
Setting of Function	12
Default setting	12
Other Settings	22
Maintenance	25
Troubleshooting	26
Specification	33
Specifications	33
Dimensions	34



# Safety Instructions

These safety instructions are intended to prevent hazardous situations and/or equipment damage. These instructions indicate the level of potential hazard with the labels of "Caution", "Warning" or "Danger".

They are all important notes for safety and must be followed in addition to International Standards (ISO/IEC)\*1), and other safety regulations.

\*1) ISO 4414: Pneumatic fluid power -- General rules relating to systems.

ISO 4413: Hydraulic fluid power -- General rules relating to systems.

IEC 60204-1: Safety of machinery -- Electrical equipment of machines. (Part 1: General requirements)

ISO 10218: Manipulating industrial robots -Safety.

etc.



## Caution

**Caution** indicates a hazard with a low level of risk which, if not avoided, could result in minor or moderate injury.



## Warning

**Warning** indicates a hazard with a medium level of risk which, if not avoided, could result in death or serious injury.



## Danger

**Danger** indicates a hazard with a high level of risk which, if not avoided, will result in death or serious injury.

## Warning

### 1. The compatibility of the product is the responsibility of the person who designs the equipment or decides its specifications.

Since the product specified here is used under various operating conditions, its compatibility with specific equipment must be decided by the person who designs the equipment or decides its specifications based on necessary analysis and test results.

The expected performance and safety assurance of the equipment will be the responsibility of the person who has determined its compatibility with the product.

This person should also continuously review all specifications of the product referring to its latest catalog information, with a view to giving due consideration to any possibility of equipment failure when configuring the equipment.

### 2. Only personnel with appropriate training should operate machinery and equipment.

The product specified here may become unsafe if handled incorrectly.

The assembly, operation and maintenance of machines or equipment including our products must be performed by an operator who is appropriately trained and experienced.

### 3. Do not service or attempt to remove product and machinery/equipment until safety is confirmed.

1. The inspection and maintenance of machinery/equipment should only be performed after measures to prevent falling or runaway of the driven objects have been confirmed.

2. When the product is to be removed, confirm that the safety measures as mentioned above are implemented and the power from any appropriate source is cut, and read and understand the specific product precautions of all relevant products carefully.

3. Before machinery/equipment is restarted, take measures to prevent unexpected operation and malfunction.

### 4. Contact SMC beforehand and take special consideration of safety measures if the product is to be used in any of the following conditions.

1. Conditions and environments outside of the given specifications, or use outdoors or in a place exposed to direct sunlight.

2. Installation on equipment in conjunction with atomic energy, railways, air navigation, space, shipping, vehicles, military, medical treatment, combustion and recreation, or equipment in contact with food and beverages, emergency stop circuits, clutch and brake circuits in press applications, safety equipment or other applications unsuitable for the standard specifications described in the product catalog.

3. An application which could have negative effects on people, property, or animals requiring special safety analysis.

4. Use in an interlock circuit, which requires the provision of double interlock for possible failure by using a mechanical protective function, and periodical checks to confirm proper operation.



# Safety Instructions

## Caution

### **1. The product is provided for use in manufacturing industries.**

The product herein described is basically provided for peaceful use in manufacturing industries. If considering using the product in other industries, consult SMC beforehand and exchange specifications or a contract if necessary.  
If anything is unclear, contact your nearest sales branch.

## **Limited warranty and Disclaimer/Compliance Requirements**

The product used is subject to the following "Limited warranty and Disclaimer" and "Compliance Requirements".

Read and accept them before using the product.

### **Limited warranty and Disclaimer**

#### **1. The warranty period of the product is 1 year in service or 1.5 years after the product is delivered, whichever is first.\*2)**

Also, the product may have specified durability, running distance or replacement parts. Please consult your nearest sales branch.

#### **2. For any failure or damage reported within the warranty period which is clearly our responsibility, a replacement product or necessary parts will be provided.**

This limited warranty applies only to our product independently, and not to any other damage incurred due to the failure of the product.

#### **3. Prior to using SMC products, please read and understand the warranty terms and disclaimers noted in the specified catalog for the particular products.**

**\*2) Vacuum pads are excluded from this 1 year warranty.**

A vacuum pad is a consumable part, so it is warranted for a year after it is delivered. Also, even within the warranty period, the wear of a product due to the use of the vacuum pad or failure due to the deterioration of rubber material are not covered by the limited warranty.

### **Compliance Requirements**

#### **1. The use of SMC products with production equipment for the manufacture of weapons of mass destruction (WMD) or any other weapon is strictly prohibited.**

#### **2. The exports of SMC products or technology from one country to another are governed by the relevant security laws and regulation of the countries involved in the transaction. Prior to the shipment of a SMC product to another country, assure that all local rules governing that export are known and followed.**

## Caution

### **SMC products are not intended for use as instruments for legal metrology.**

Products that SMC manufactures or sells are not measurement instruments that are qualified by pattern approval tests relating to the measurement laws of each country.

Therefore, SMC products cannot be used for business or certification ordained by the measurement laws of each country.

## Operator

- ◆ This operation manual is intended for those who have knowledge of machinery using pneumatic equipment, and have sufficient knowledge of assembly, operation and maintenance of such equipment. Only those persons are allowed to perform assembly, operation and maintenance.
- ◆ Read and understand this operation manual carefully before assembling, operating or providing maintenance to the product.

### ■ Safety Instructions

#### **Warning**

- Do not disassemble, modify (including changing the printed circuit board) or repair.  
An injury or failure can result.
- Do not operate the product outside of the specifications.  
Do not use for flammable or harmful fluids.  
Fire, malfunction, or damage to the product can result.  
Verify the specifications before use.
- Do not operate in an atmosphere containing flammable or explosive gases.  
Fire or an explosion can result.  
This product is not designed to be explosion proof.
- Do not use the product in a place where static electricity is a problem.  
Otherwise it can cause failure or malfunction of the system.
- If using the product in an interlocking circuit:
  - Provide a double interlocking system, for example a mechanical system
  - Check the product regularly for proper operationOtherwise malfunction can result, causing an accident.
- The following instructions must be followed during maintenance:
  - Turn off the power supply
  - Stop the air supply, exhaust the residual pressure and verify that the air is released before performing maintenanceOtherwise an injury can result.

## Caution

■ Do not touch the terminals and connectors while the power is on.  
Otherwise electric shock, malfunction or damage to the product can result.

■ After maintenance is complete, perform appropriate functional inspections and leak tests.  
Stop operation if the equipment does not function properly or there is a leakage of fluid.  
When leakage occurs from parts other than the piping, the product might be faulty.  
Disconnect the power supply and stop the fluid supply.  
Do not apply fluid under leaking conditions.  
Safety cannot be assured in the case of unexpected malfunction.

## ■ NOTE

○ Follow the instructions given below when designing, selecting and handling the product.

● The instructions on design and selection (installation, wiring, environment, adjustment, operation, maintenance, etc.) described below must also be followed.

\*Product specifications

● The direct current power supply to be used should be UL approved as follows.

Circuit (of Class2) which is of maximum 30 Vrms (42.4 V peak) or less, with UL1310 Class2 power supply unit or UL1585 Class2 transformer.

● The Pressure switch is a UL approved product only if it has a  mark on the body.

● The Pressure switch designed only for the measurement of compressed air (including vacuums).

The compressed air must contain no chemicals, synthetic oil with organic solvent, salts nor corrosive gas.

Air that includes these substances can cause damage or malfunction of the Pressure switch.

Verify the specifications carefully before use.

● Do not use the Pressure switch for compressed air containing plenty of condensed water.

Otherwise it can cause malfunction of the Pressure switch.

When measuring the air with condensed water, install an air dryer / drain catch before a filter, and drain the condensed water regularly.

Improper draining of condensed water allows the flow with condensed water into the secondary side and causes malfunction of pneumatic equipment.

Use of the filter with an auto drain is recommended when the draining is difficult to perform.

Compressed air quality should comply with JIS B 8392-1 1.1.2 through 1.6.2:2003.

● Use the specified voltage.

Operation with a voltage outside of specifications can cause malfunction or damage of the Pressure switch.

Insufficient voltage may not drive a load due to a voltage drop inside the Pressure switch.

Verify the operating voltage of the load before use.

● Use the Pressure switch within the specified ranges of the measurement flow rate and operating pressure.

Otherwise it can cause damage to the Pressure switch and abnormal measurement.

Do not apply a constant pressure higher than 0.5 MPa to vacuum Pressure switch. (Specifications: -101 to 101 kPa)

● Do not exceed the specified maximum allowable load.

Otherwise it can cause damage or shorten the lifetime of the Pressure switch.

● Input data to the Pressure switch is not erased after the power is off. (Writing time: 100,000 times)

● Reserve a space for maintenance.

Consider a space for maintenance when designing whole system.

## ●Product handling

### \*Installation

- Do no drop, hit or apply shock to the Pressure switch.  
Otherwise it can result in damage to the Pressure switch causing failure or malfunction.
- Do not pull lead wires or lift the body with lead wires. (Tensile force 50N or less)  
Hold the body when handling.  
Otherwise it can result in damage of the Pressure switch causing failure or malfunction.
- Follow the specified tightening torque  
Excessive tightening torque can break the Pressure switch, bracket, and mounting screws.  
Insufficient tightening torque can displace the Pressure switch from the original position or loosen the mounting screws.
- Eliminate any dust left in the piping by air blow before connecting the piping to the Pressure switch.  
When using a sealing tape, leave a couple of threads exposed.  
Otherwise it can cause damage or malfunction.
- Do not insert wires or other foreign matter into the pressure measurement port.  
It can damage the pressure sensor causing failure or malfunction.
- Connect terminal frame-ground (FG) to the ground when using a switch-mode power supply.

### \*Wiring

- Avoid repeatedly bending or stretching the lead wires.  
Wiring with repetitive bending stress or tensile stress can cause breakage of the lead wires.  
Replace the product when damage to a lead wire is observed.
- Wire correctly.  
Incorrect wiring can break the Pressure switch depending on a miswired circuit.
- Do not perform wiring while the power is on.  
Otherwise it can break the circuit inside the Pressure switch causing malfunction.
- Do not route wires or cables together with power or high-voltage cable.  
Otherwise the wires to the Pressure switch can be contaminated with noise or induced surge voltage from the power or high-voltage line causing malfunction.  
Lay the wires to the Pressure switch to a wire duct or in a protective tube other than those for the power or high-voltage cables.
- Confirm proper insulation of wiring.  
Poor insulation (interference with other circuit, poor insulation between terminals, etc.) can introduce over voltage or current to the Pressure switch causing damage.
- Keep wiring as short as possible to prevent contamination from noise and induced surge voltage.  
Do not use a cable longer than 30 m. Consult with SMC for the use with a cable longer than 30 m.  
Connect 0 VDC wire (blue line) directly or as close as possible to 0 VDC terminal of the DC power supply.

### \*Environment

- Do not use the Pressure switch in environment containing corrosive gas, chemicals, sea water, water or vapor, or in a place where there is a possibility of adhesion of those substances to the Pressure switch.  
It can cause failure or malfunction.
- Avoid exposure of the Pressure switch to direct sunlight.  
Use sunshade if the Pressure switch is exposed to direct sunlight.  
Otherwise it can cause failure or malfunction.
- Do not use in a place where water, oil or chemicals splashes.  
Otherwise it can cause failure or malfunction.
- Do not use the Pressure switch nearby a place where electric surges are generated.  
Internal circuit elements of the Pressure switch can deteriorate or break when equipment generating a large surge (electromagnetic lifter, high frequency induction furnace, motor, etc.) is located near the Pressure switch. Provide surge preventives, and avoid interference.
- Do not use a load which generates surge voltage.  
Relays or solenoid valves generate electric surge voltage. When using the Pressure switch to drive these loads directly, provide a surge absorber.

- The Pressure switch is not resistive to a lightning surge defined in CE marking. Take measures to protect against a lightning surge at the load side.
- Prevent foreign matter such as remnant of wires from entering the Pressure switch.  
Take proper measures for the remnant not to enter the Pressure switch in order to prevent failure or malfunction.
- Follow the specified range of the fluid and ambient temperatures.  
The fluid and ambient temperatures should be 0 to 50 °C.  
When operating at a temperature below 5 °C, breakage or malfunction can occur to the Pressure switch due to freezing of condensed water in the compressed air.  
Take preventive measures against freezing. Installation of an air dryer is recommended in order to remove condensed water contained in the measured fluid.  
Do not use the Pressure switch in a place where temperature suddenly changes even if it stays within the specified range.
- Do not expose the Pressure switch to heat radiation from a heat source located nearby.  
It can cause malfunction.

#### \*Adjustment and Operation

- Do not short-circuit the load.  
The Pressure switch indicates the error status when a load is short-circuited. However, over current can damage the Pressure switch.
- Do not press the set buttons with a sharp pointed object.  
It can cause damage to the set buttons.
- Warm up for 20 to 30 minutes for the detection of low pressure.  
The indication drifts about  $\pm 1\%$  soon after the power is on.

#### \*Maintenance



- Before performing maintenance, make sure to turn off the power supply, stop supplied air, release the residual air in the piping into the atmosphere, and verify that the pneumatic system is open to the air.  
Otherwise an unexpected operation of the system component can occur.
- Perform maintenance and check regularly.  
Otherwise an unexpected malfunction of the system component can occur due to a malfunction of the Pressure switch.
- Perform proper functional checks and leak test after maintenance.  
Stop operation when an abnormality is observed such that the Pressure switch does not work properly or there is a leakage of fluid.  
Otherwise an unexpected malfunction of the system component can occur.
- Drain condensed water regularly.  
The flow of condensed water to the secondary side can cause a malfunction of pneumatic equipment.
- Do not use solvents such as benzene or thinner to clean the Pressure switch body.  
It can damage the surface of the body and erase the indication on the body.  
Use a soft cloth to remove stains. For heavy stains, use a cloth soaked with diluted neutral detergent and fully squeezed, then wipe up the stains again with a dry cloth.



# Model Identification and How to Order

ISE35- **N** - **25** - **M** □ □

Electrical entry

Symbol	N	R
	Electrical entry (Bottom)	Electrical entry (Top)
Content		

Output specification

Symbol	Content
25	NPN open collector output
65	PNP open collector output

Option 2

Symbol	Content
Nil	No option
A	With kit for mounting of modular AR/AW series *2
B	With kit for mounting of ARM10/11 series *2

\*2: An adapter, O-ring, lock pin and two mounting screws are attached.  
 \*: Cannot be used for AR/AW-D series.

Option 1

Symbol	Content
Nil	No option
L	Lead wire with connector (2 m)

Unit specification

Symbol	Content
Nil	With unit conversion function *1
M	Fixed SI unit
P	Pressure unit: psi (Initial value) With unit conversion function *1



\*1: The new Measurement Law prohibits the use of pressure switch with the unit conversion function in Japan.  
 A unit label is attached.

oMade to Order

AR/AW-D Series - Mounting kit is included  
 (An adapter, O-ring, lock pin and two mounting screws are attached.)

ISE35- **N** - **25** - **M** □ **A-X523**

Electrical entry

Symbol	N	R
	Electrical entry (Bottom)	Electrical entry (Top)
Content		

Output specification

Symbol	Content
25	NPN open collector output
65	PNP open collector output

Option 1

Symbol	Content
Nil	No option
L	Lead wire with connector (2 m)

Unit specification

Symbol	Content
Nil	With unit conversion function *1
M	Fixed SI unit
P	Pressure unit: psi (Initial value) With unit conversion function *1

\*1: The new Measurement Law prohibits the use of pressure switch with the unit conversion function in Japan.  
 A unit label is attached.

## Summary of Product parts

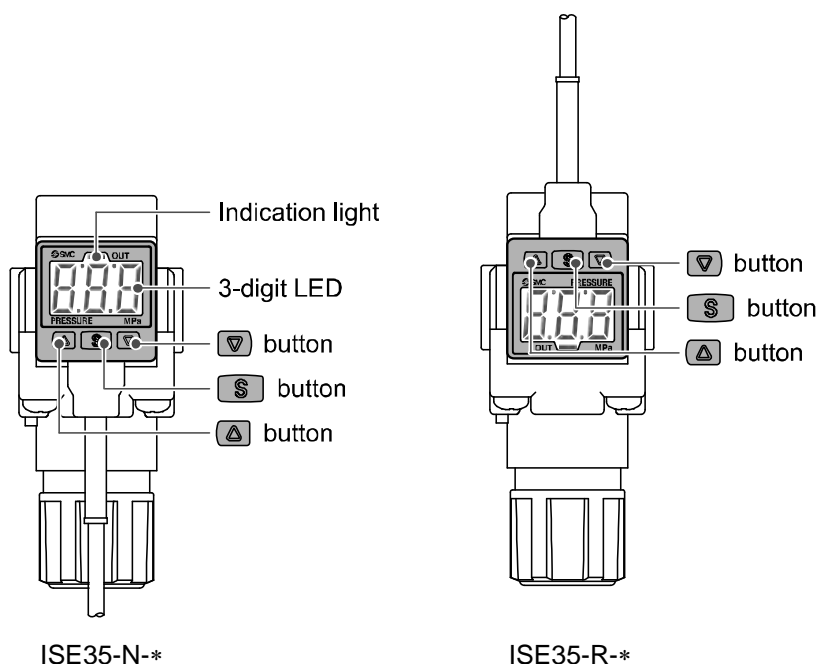

### Names of individual parts



Indication light (Green LED): Displays the operation condition of the Pressure switch.

3-digit LED: Displays the current status of pressure, setting mode and error code.

Four display modes can be selected display always in red or green only, or switch from green to red, or red to green linking to output.

-  button: Increases the mode and ON/OFF set value.  
Press this button to change to the peak display mode.
-  button: Decreases the mode or ON/OFF set value.  
Press this button to change to the bottom display mode.
-  button: Press this button to change to another mode and to set a set value.

# Mounting and Installation

## ■Wiring

### ○Connection

- Connections should only be made with the power supply turned off.
- Use separate routes for the Pressure switch wiring and any power or high voltage wiring. Otherwise, malfunction may result due to noise.
- Ensure that the FG terminal is connected to ground when using a commercially available switch-mode power supply. When a switch-mode power supply is connected to the product, switching noise will be superimposed and the product specification can no longer be met. This can be prevented by inserting a noise filter, such as a line noise filter and ferrite core, between the switch-mode power supply and the product, or by using a series power supply instead of a switch-mode power supply.

### ○Connector

#### Connecting/Disconnecting

- When connecting the connector, insert it straight onto the pin holding the lever and connector body between fingers and lock the connector by pushing the lever claw into the concave in the body of switch.
- When disconnecting the connector, push down the lever by thumb to disengage the lever claw from the concave. Then pull the connector straight out.

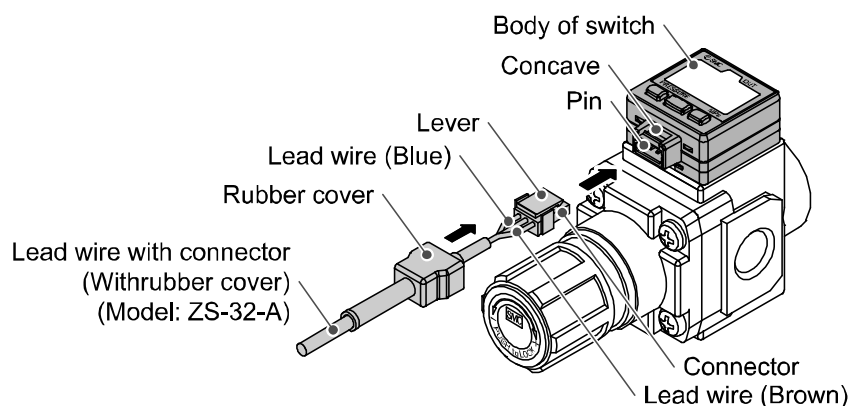

### ○Output specification

Use a separate route when installing wire.

Malfunction stemming from noise may occur if wire is installed in the When the lead wire with connector provided by SMC is used, the colors of wire (Brown, Black, Blue) will apply as shown on circuit diagram.

#### -25

NPN open collector output  
Max.30 V, 80 mA  
Residual voltage 1 V or less

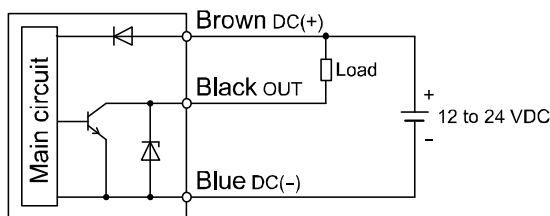

#### -65

PNP open collector output  
Max.80 mA  
Residual voltage 1 V or less

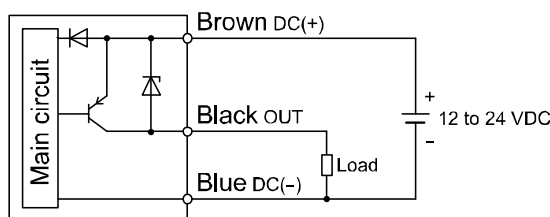

# Pressure Setting

## Operation

When the pressure exceeds the set value, the switch will be turned ON.

When the pressure falls below the set value by amount of hysteresis or more, the switch will be turned OFF.

As a default setting, the Pressure switch is set to turn ON when the pressure exceeds 0.35 MPa, and turn OFF when it lowers 0.34 MPa.

If the operation shown below does not cause any problem, keep this setting.

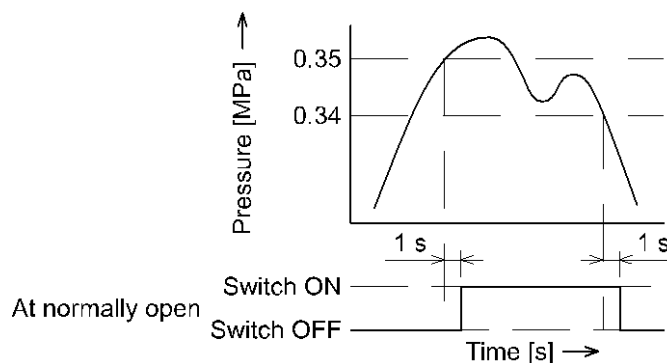

## <How to perform>

1. Press the button in the measurement mode to display set values.

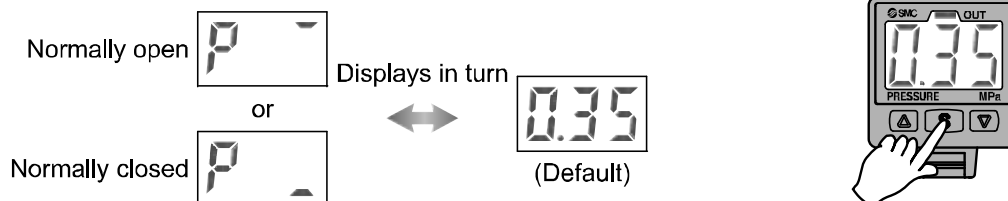

2. Press the or button to change the set value.

The button is for increase and the button is for decrease.

- Press the button once to increase by one figure and press it continuously to keep set figure increased.

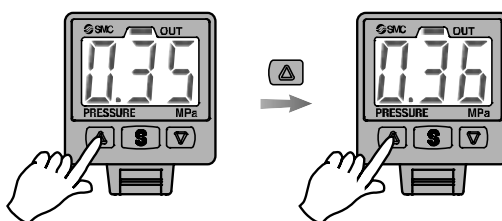

- Press the button once to decrease by one figure and press it continuously to keep set figure decreased.

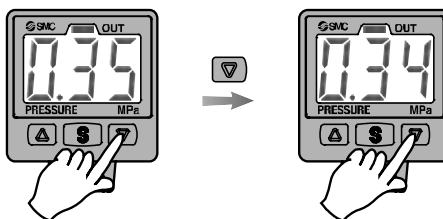

3. Press the button to finish the setting.

For setting in window comparator mode, refer to "Pressure setting (in window comparator mode)" on page 16.

## Setting of Function

### ■ Default setting

As the time of shipment, the following settings are provided.

If the setting is acceptable, keep it for use.

If the different setting is necessary, change the setting with reference to each page.

Setting item	Page	Default setting
<b>Switch output</b> Selects whether or not the Pressure switch output is made available. If the switch output is unnecessary, it is available just like a pressure gauge.	page 14	ON
<b>Indication color</b> Selects the color to indicate.	page 14	ON: Green OFF: Red
<b>Response time</b> Sets of a response time prevents chattering in output.	page 15	1 s
<b>Operation mode</b> Selects the mode to operate the Pressure switch.	page 15	Hysteresis mode
<b>Hysteresis</b>	page 17	0.01 MPa (1 psi)
<b>Output type</b> Sets the method to generate the switch output.	page 17	Normally open
<b>Power saving mode</b> Selects the power saving mode.	page 18	OFF
<b>Secret code input</b> Selects the necessity of secret code input for key lock.	page 18	OFF

The value in ( ) is for the indication unit "P".

### ○ Setting of special function

Setting item	Page
<b>Indication mode</b> Reverse the indication mode.	page 20
<b>Indication unit (available with unit conversion function)</b>	page 21

### ○ NOTE

When the default setting is changed, since the different setting item appears in order depending on how many times the  button is pressed, confirm the item which needs to be set appears correctly and prevent undesired setting.

### ■ Measurement mode

The mode in which the pressure is detected and displayed, and the switch function is operating.

This is the basic operating mode; other modes should be selected for set-point And other function setting changes.

The power is supplied.



The symbol to show the indication unit appears for approx. 1 sec.

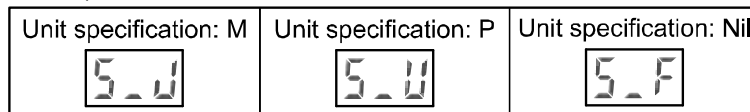

The measurement mode comes and the current pressure is indicated

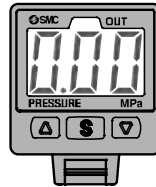

## 1. Switch output ( 50 )



The necessity of switch output can be set.

If no need of switch output is selected, the switch does not generate the output and functions just like a pressure gauge. In this case, only indication color changes correspondingly to the pressure setting change. The operation indication does not work.

### <How to perform>

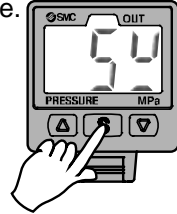
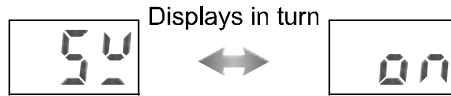
1. Keep pressing the  button for 2 seconds or longer in the measurement mode.  
[ 50 ] and current setting appears in turn.



2. Press the  or  button to select the necessity of switch output.

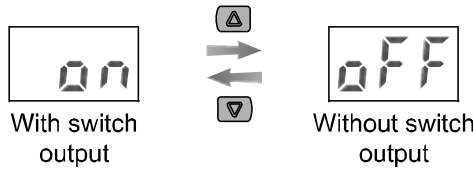



3. Keep pressing the  button for 2 seconds or longer after selection is completed.  
Then, the setting is finished, and the measurement mode returns.

## 2. Indication color ( 01 )

There are 4 indication types available.

Switch		Display
ON	OFF	
Red	Green	Sor
Green	Red	SoG
Red		rEd
Green		Grn

### <How to perform>

1. Keep pressing the  button for 2 seconds or longer in the measurement mode.  
After " 50 " is indicated, press the  button once.  
Then, [ 01 ] and current setting appears in turn.

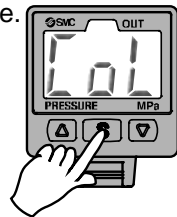
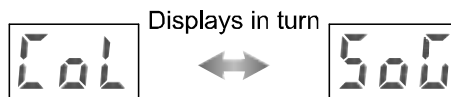

2. Press the  or  button to select an indication color.

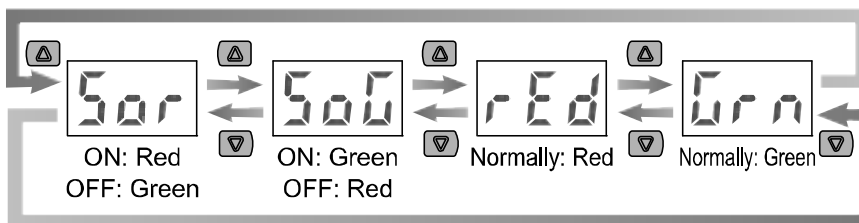

3. Keep pressing the  button for 2 seconds or longer after selection is completed.  
Then, the setting is finished, and the measurement mode returns.



### 3. Response time (rES)

The response time of the switch output can be set optionally.

If the response time is changed, the indication updating interval correspondingly changes.

If the changed response time causes the chattering in the switch output or indication, set the response time longer.

#### <How to perform>

1. Keep pressing the  button for 2 seconds or longer in the measurement mode.  
After [ 5.4 ] is indicated, press the  button twice.  
Then, [rES] and current setting appears in turn.

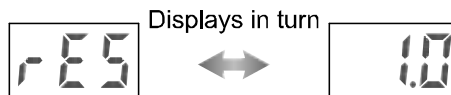

2. Press the  or  button to select the response time.

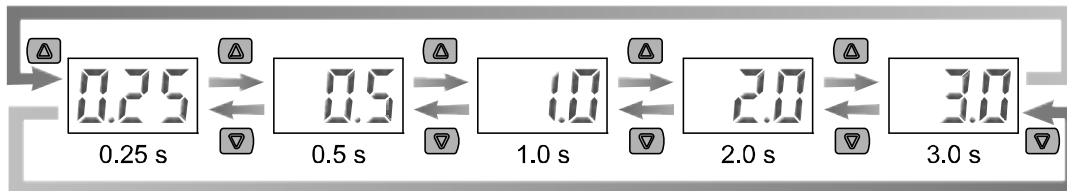



3. Keep pressing the  button for 2 seconds or longer after selection is completed.  
Then, the setting is finished, and the measurement mode returns.

### 4. Operation mode (oPE)

The switch operation mode can be selected.

For the operation in hysteresis mode and window comparator mode, refer to "List of output mode" on page 19.

#### <How to perform>

1. Keep pressing the  button for 2 seconds or longer in the measurement mode.  
After [ 5.4 ] is indicated, press the  button three times.  
Then, [oPE] and current setting appears in turn.

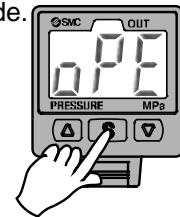
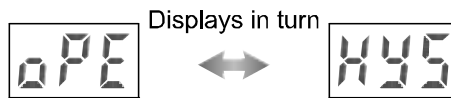

2. Press the  or  button to select the operation mode.

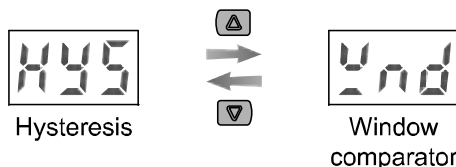

3. Keep pressing the  button for 2 seconds or longer after selection is completed.  
Then, the setting is finished, and the measurement mode returns.





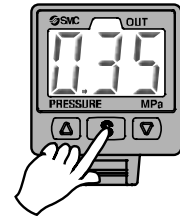
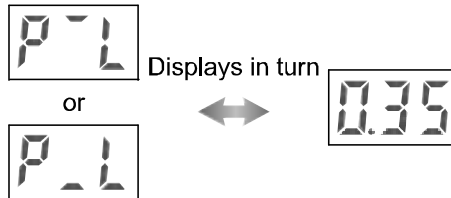

## Pressure setting (in window comparator mode)

### <How to perform>

1. Press the  button in the measurement mode to display set value.



2. Press the  or  button to change the set value.  
The  button is for increase and the  button is for decrease.

- Press the  button once to increase by one figure and press it continuously to keep set figure increased.





- Press the  button once to decrease by one figure and press it continuously to keep set figure decreased.

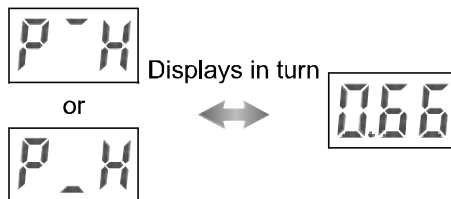

3. Pressing the  button, set value for the second setting item is displayed.





4. Press the  or  button to change the set value.
5. Press the  button to finish the setting.



## 5. Hysteresis ( H )

The hysteresis can be set.

### <How to perform>

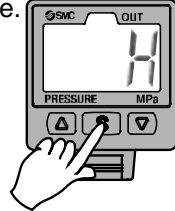
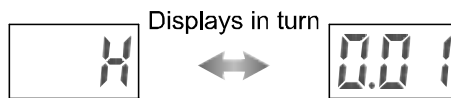
1. Keep pressing the  button for 2 seconds or longer in the measurement mode.  
After [ 5.4 ] is indicated, press the  button four times.  
Then, [ H ] and current setting appears in turn.



2. Press the  or  button to select the hysteresis.

- Press the  button once to increase by one figure and press it continuously to keep set figure increased.



- Press the  button once to decrease by one figure and press it continuously to keep set figure decreased.





3. Keep pressing the  button for 2 seconds or longer after selection is completed.  
Then, the setting is finished, and the measurement mode returns.

## 6. Output type ( out )

A desired output mode can be set freely for switch output.

For the operation in normally open and normally closed, refer to "List of output mode" on page 19.

### <How to perform>

1. Keep pressing the  button for 2 seconds or longer in the measurement mode.  
After [ 5.4 ] is indicated, press the  button five times.  
Then, [ out ] and current setting appears in turn.

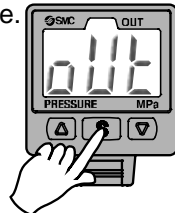
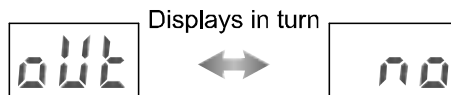

2. Press the  or  button to select the output type.





3. Keep pressing the  button for 2 seconds or longer after selection is completed.  
Then, the setting is finished, and the measurement mode returns.

## 7. Power saving mode (P<sub>04</sub>)

When the power saving mode is selected, the value goes off to reduce current consumption.

### <How to perform>

1. Keep pressing the  button for 2 seconds or longer in the measurement mode.  
After [ 5.4 ] is indicated, press the  button six times.  
Then, [ P<sub>04</sub> ] and current setting appears in turn.

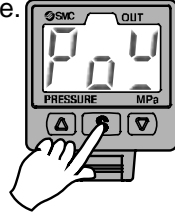

2. Press the  or  button to select the necessity of power saving mode.

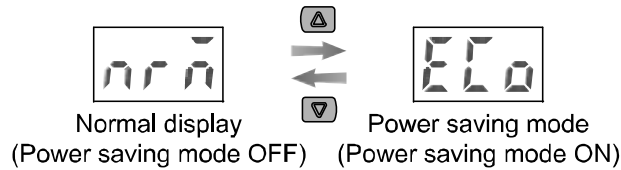

3. Keep pressing the  button for 2 seconds or longer after selection is completed.  
Then, the setting is finished, and the measurement mode returns.

In the power saving mode, the key-in operation can return the normal display. Without key-in operation for 30 seconds the power saving mode returns again (only in the measurement mode).



The display in power saving mode is as shown on right figure.





## 8. Secret code input (P<sub>10</sub>)

The necessity of secret code input for key lock can be selected.

### <How to perform>

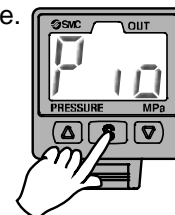
1. Keep pressing the  button for 2 seconds or longer in the measurement mode.  
After [ 5.4 ] is indicated, press the  button seven times.  
Then, [ P<sub>10</sub> ] and current setting appears in turn.



2. Press the  or  button to select the necessity of secret code.

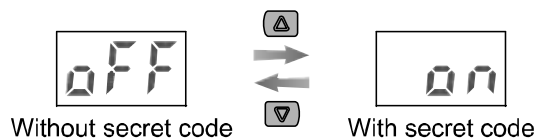

3. Keep pressing the  button for 2 seconds or longer after selection is completed.  
Then, the setting is finished, and the measurement mode returns.

With secret code input, it becomes necessary to input the secret code to release key lock. The secret code can be saving mode is returned again. The secret code can be decided optionally by the operator. At the time of shipment, the secret code is set to "000".

With secret code input, refer to page 24.

•List of output mode

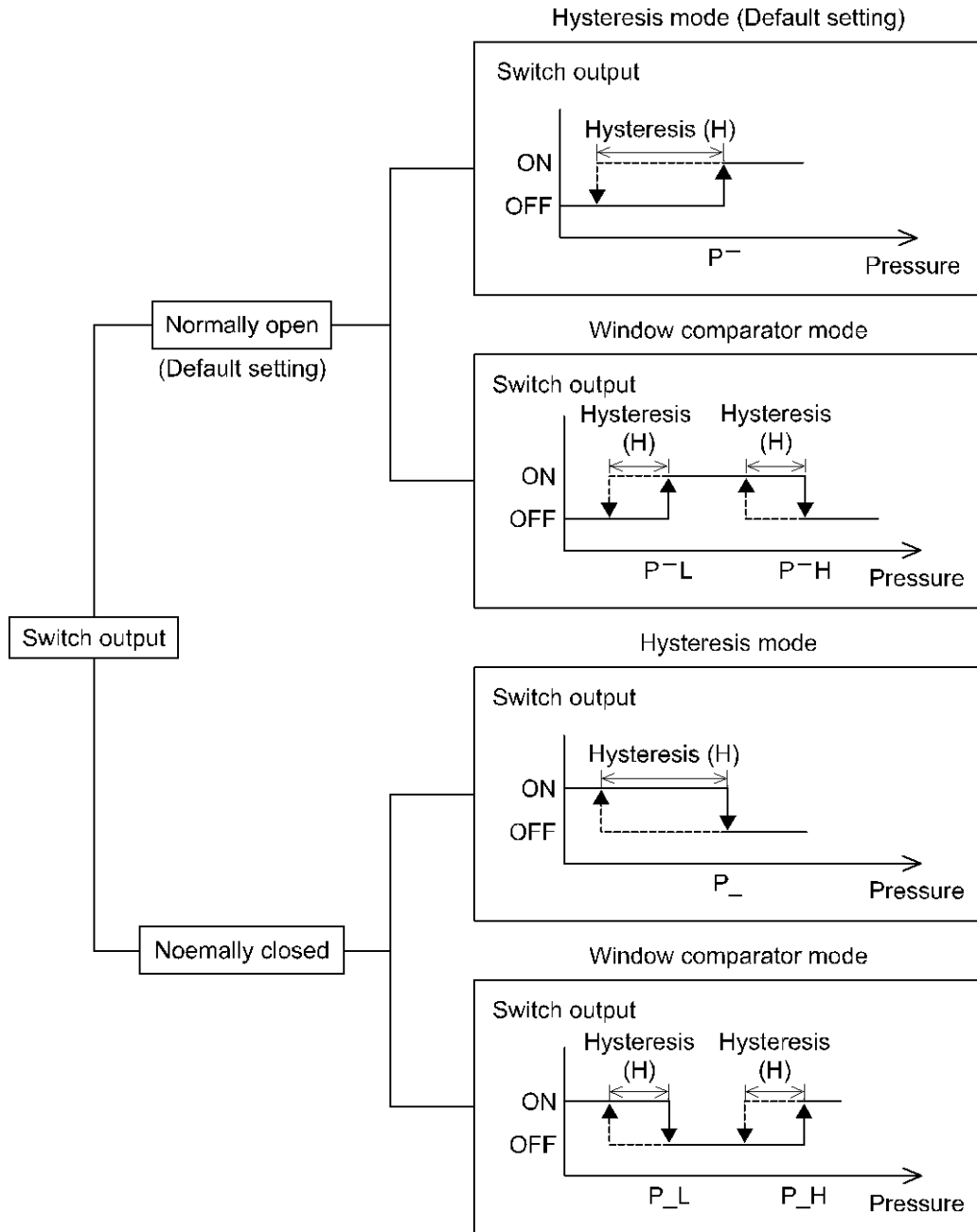

If the point where the switch output is changed comes outside of set pressure range due to the change of set pressure, hysteresis(H) is automatically compensated.

● **Indication mode (d 15)**



The display can be reversed.

This setting is necessary to change the indication mode on receipt of the Pressure switch.

<How to perform>

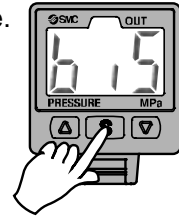
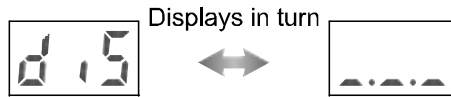
1. Keep pressing the  button for 2 seconds or longer in the measurement mode.  
After [ 5.4 ] is indicated, press button eight times.  
Then, [ d 15 ] and current setting appears in turn.



2. Press the  or  button to select the indication mode.

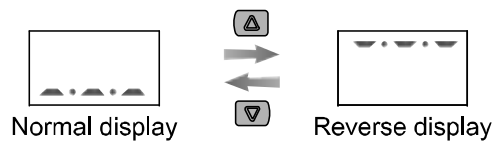

3. Keep pressing the  button for 2 seconds or longer after selection is completed.  
Then, the setting is finished, and the measurement mode returns.

If reverse indication is selected, the button operation is changed as shown on right figure.

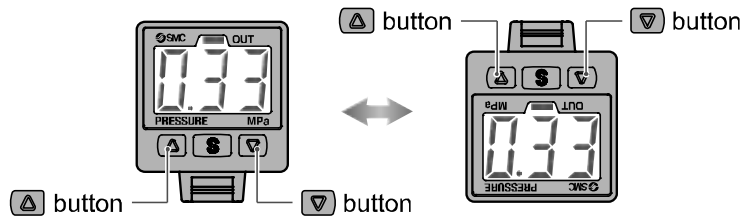

● **Indication unit (Unit)** (available with unit conversion function)

The indication unit can be selected freely.

	Setting and display resolution
MPa	0.01
Kgf/cm <sup>2</sup>	0.1
bar	0.1
psi	1

<How to perform>

1. Press the  button three times in the measurement mode.

[Unit] and current setting appears in turn.

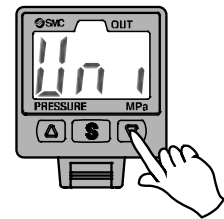
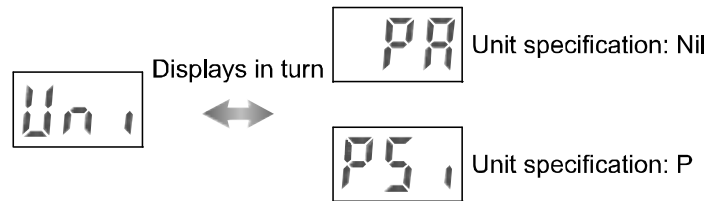

2. Press the  or  button to select the indication unit

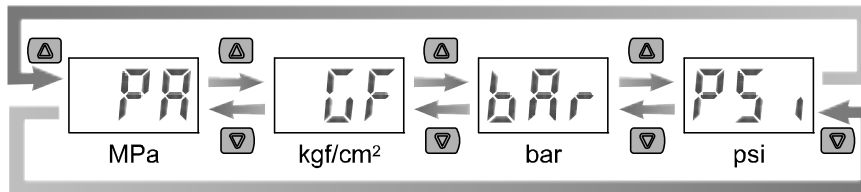

3. Press the  button to enter the setting.

The measurement mode returns.

**Caution**

- If the indication units are changed, the set value and hysteresis should be set again.

## Other Settings

### ○Peak/Bottom hold value indication

The maximum (minimum) pressure from when the power is supplied to this moment is detected and updated. In the peak/bottom indication mode, the pressure is indicated.

As the peak indication, when the  button is pressed for 1 second or longer, the maximum pressure starts flashing and is held.



To release holding the indication of the maximum pressure, press the  button for 1 second or longer again.

The measurement mode returns.

As the bottom indication, when the  button is pressed for 1 second or longer, the minimum pressure starts flashing and is held.

To release holding the indication of the minimum pressure, press the  button for 1 second or longer again.



The measurement mode returns.

If the  and  buttons are pressed simultaneously for 1 second or longer while the pressure is being held, the maximum (minimum) value is initialized.

### ○Zero clear

A displayed value can be adjusted to zero when the pressure to be measured is within  $\pm 10\%$ F.S. of the pressure at the time of shipment from the factory.

(The range of  $\pm 1$  digit setting is different depending on the individual product difference.)

Press continuously the  and  buttons for 1 second or longer simultaneously, display is cleared as "0". The measurement mode returns automatically.

### ○Key lock



A wrong operation performed unintentionally such as change of set value can be prevented.

If the button operation is performed while key lock setting is being performed, [LoL] is indicated for approx. 1 second.

#### <How to perform -without secret code input->

1. Keep pressing the  button for 5 seconds or longer in the measurement mode.  
The current setting [UnL] or [LoL] is indicated.  
(Releasing key lock can be done in the same way.)



2. Press the  or  button to select locking or unlocking of the key.

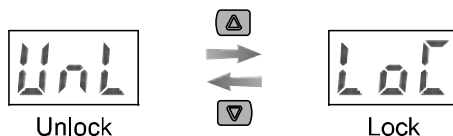



3. Press the  button to enter the setting.

### <How to perform -with secret code input->

#### ●Locking

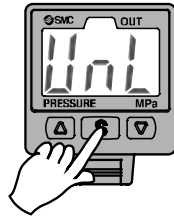
1. Keep pressing the  button for 5 seconds or longer in the measurement mode.  
[UnL] is indicated.



2. Press the  or  button to select locking of the key [LoL].

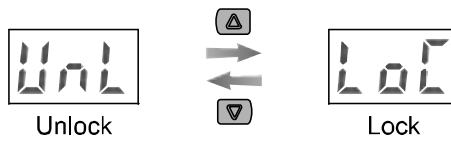



3. Press the  button to enter the setting.

#### ●Unlocking

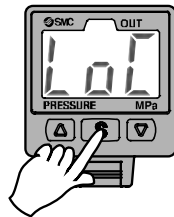
1. Keep pressing the  button for 5 seconds or longer in the measurement mode.  
[LoL] is indicated.



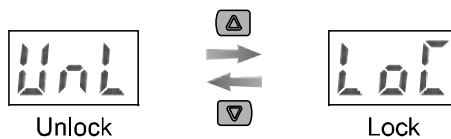

2. Press the  or  button to select unlocking of the key [UnL].

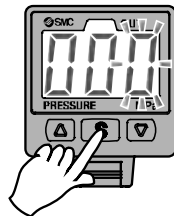

3. When the  button is pressed, the input of secret code is asked.  
For how to input the secret code, refer to "How to input and change the secret code" on page 24.



4. If inputted secret code is correct, the indication changes to [UnL], and pressing one of ,  and  buttons releases key lock, and the measurement mode returns.  
If inputted secret code is wrong, [FR] is indicated and the secret input mode returns.  
If the wrong secret code is inputted three times, [LoL] is indicated and the measurement mode returns.

If the secret code is forgotten, contact SMC.



●How to change the secret code

At the time of shipment, the secret code is set to [000], but can be changed to optional one.

<How to perform>

1. After the lock setting is finished (page 23), perform all three steps in the unlock setting procedure. (page 23, "3")
2. After the secret code is inputted and the indication changes to [UnL], keep pressing the [S] and [V] buttons simultaneously for 5 seconds or more. [000] is indicated and the change of secret code is asked.  
For how to input the secret code, refer to "How to input and change the secret code".  
Changed secret code is indicated.
3. After check it is as desired, press the [S] button.  
The measurement mode returns. At this time, if the [A] or [V] button is pressed, changed secret code is not entered and the change of secret code is asked.

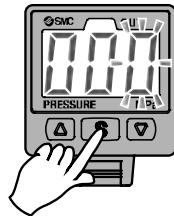

●How to input and change the secret code

The first digit starts flashing.  
Press the [A] or [V] button to set the value.  
Pressing the [S] button starts flashing the second digit.  
(If the [S] button is pressed at the uppermost digit, the first digit starts flashing again.)

After the setting is finished, keep pressing the [S] button for 1 second or longer.  
If the operation is not performed for 30 seconds during input and change of the secret code, the measurement mode returns.

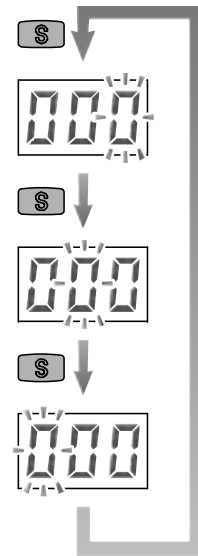

## Maintenance

### How to reset the product for power cut or forcible de-energizing

The setting of the product will be retained as it was before a power cut or de-energizing.

The output condition is also basically recovered to that before a power cut or de-energizing, but may change depending on the operating environment. Therefore, check the safety of the whole facility before operating the product.

If the facility is under accurate control, wait until it has warmed up. (Approximate 20 to 30 minutes)

### Mounting regulator

- Cut the power supply to the Pressure switch when assembling. Also, turn the set pressure of the regulator to zero.
- Mount O-ring to the O-ring groove of the regulator. Attention should be taken not to damage the O-ring.
- Set the adapter with 2 set screws.

Recommended tightening torque:

Modular AR/AW series	0.6±0.05 Nm
ARM10/11 series	0.32±0.03 Nm

- Mount the main body of the Pressure switch.
- Insert the lock pin to the adapter to the end firmly.
- Supply pressure slowly, and ensure no air leaks.
- The Pressure switch can be assembled with rotated 180 degree.

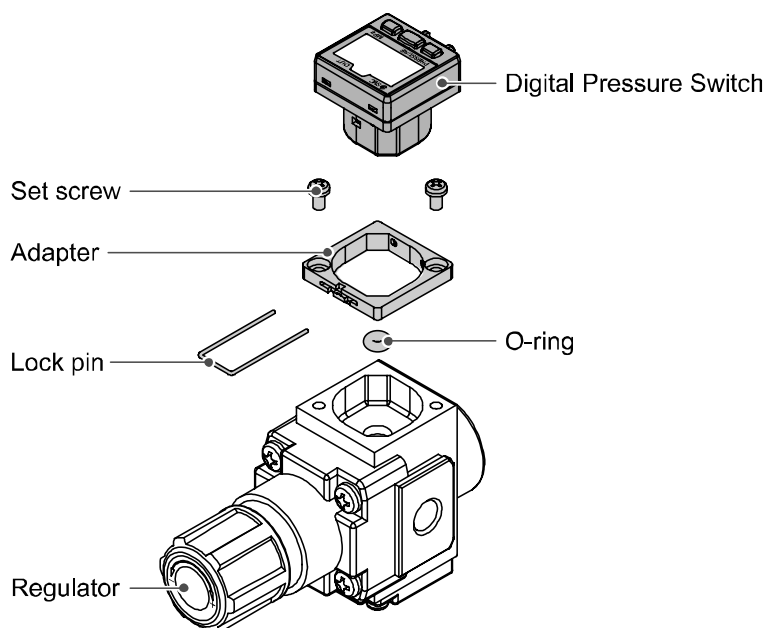

# Troubleshooting

## Applicable Pressure switch: ISE35

If a cause applicable to the failure cannot be identified and normal operation can be recovered by replacement with a new Pressure switch, this indicates that the Pressure switch itself was broken. The Pressure switch breakage can be caused by operating environment (network construction, etc.), and so consult with SMC separately to obtain countermeasures.

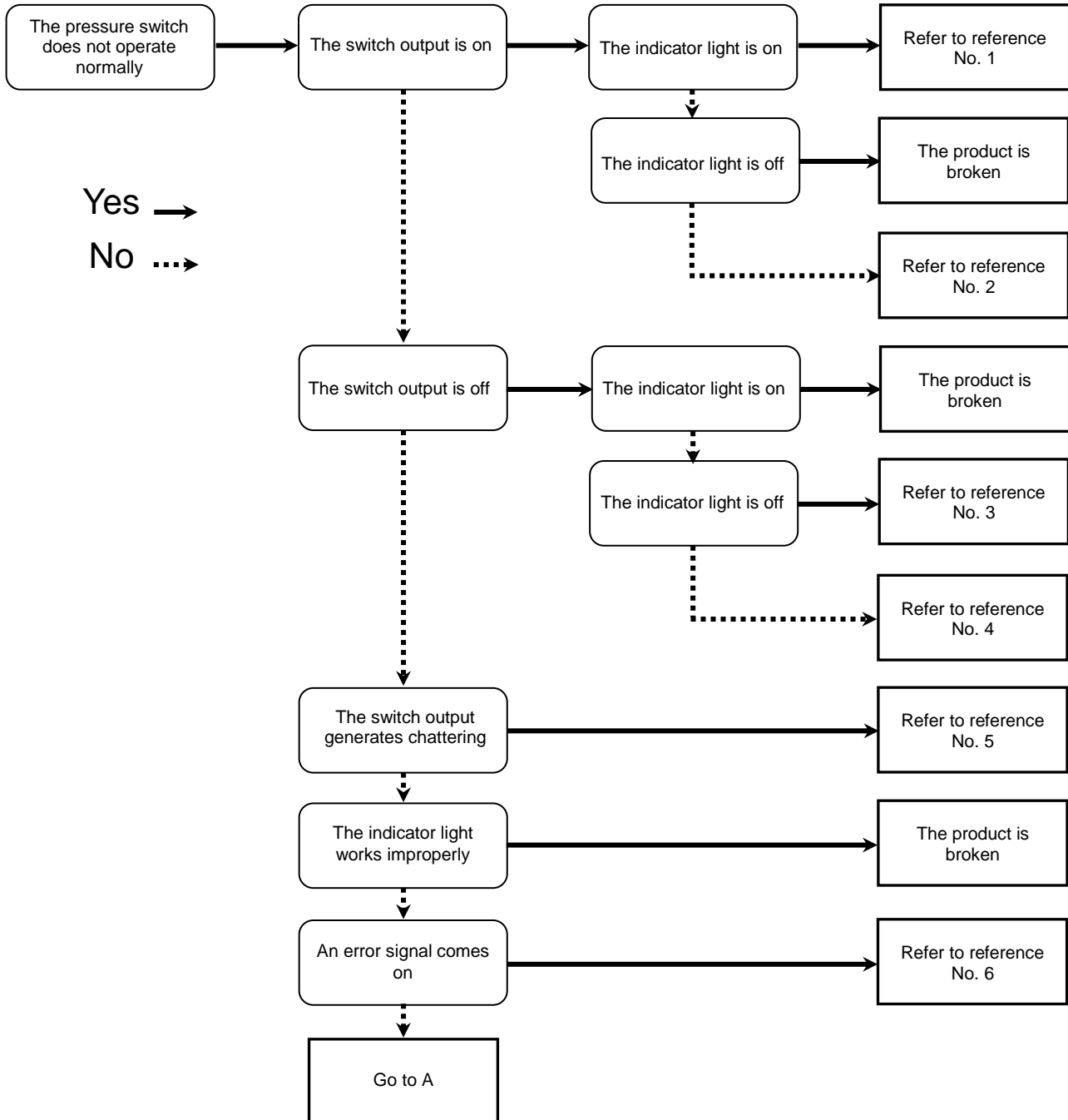

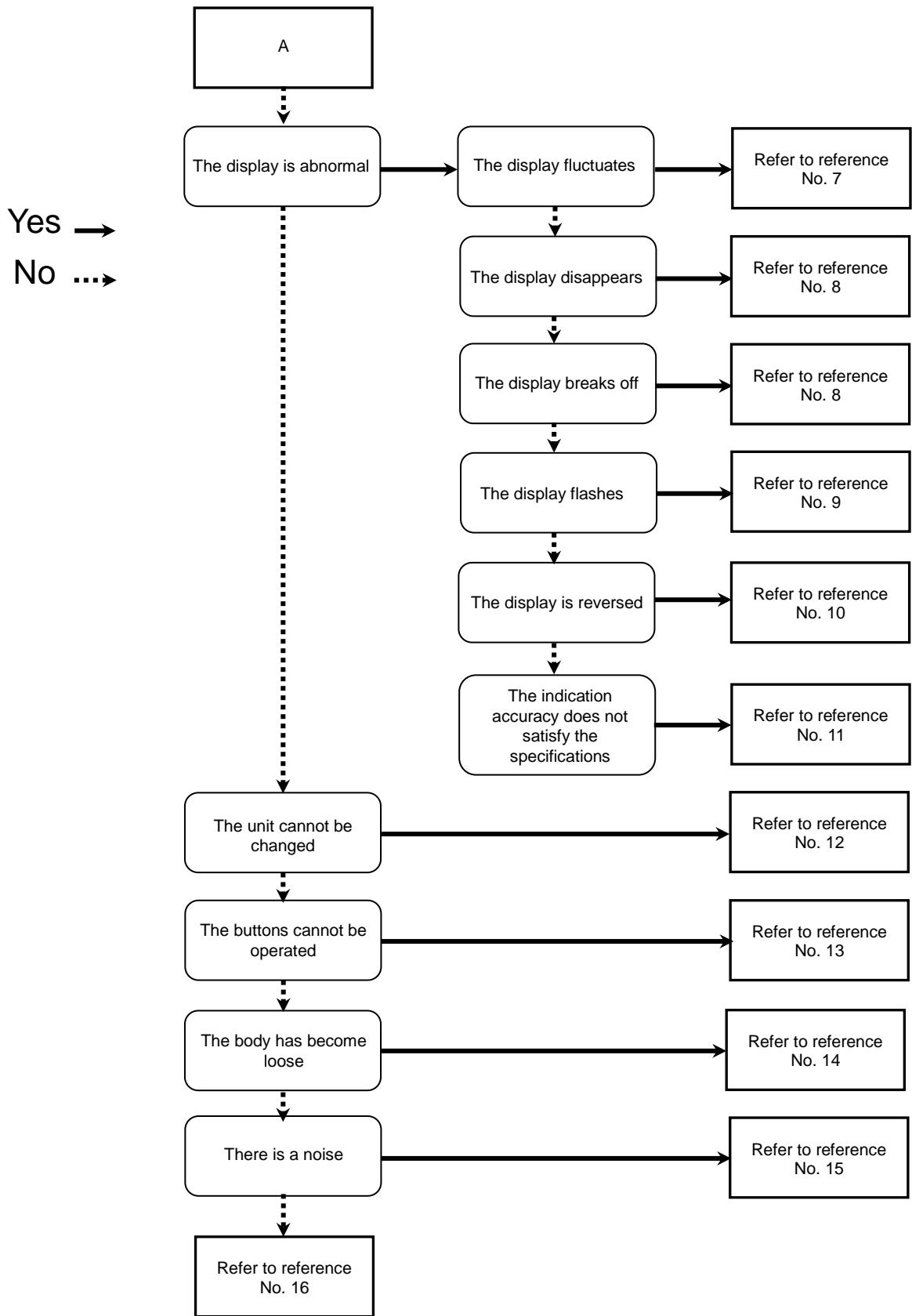

○Cross-reference for troubleshooting

Reference No.	Problem	Possible cause	Investigation method	Countermeasure
1	The output remains on. The indicator light remains on.	Wrong pressure setting	1. Check the set pressure. 2. Check the setting of the operation mode, hysteresis and output style. (Hysteresis mode/Window comparator mode, Normally open /Normally closed)	1. Set the pressure. 2. Set the function.
		Product failure		Replace the product.
2	The output remains on. The indicator light works normally.	Incorrect wiring	Check the wiring of the output line. Confirm that the load is not connected directly to DC(+) or DC(-).	Correct the wiring.
		Product failure		Replace the product.
3	The output remains off. The indicator light remains off.	Wrong pressure setting	1. Check the set pressure. 2. Check the setting of the operation mode, hysteresis and output style. (Hysteresis mode/Window comparator mode, Normally open /Normally closed)	1. Perform the pressure setting. 2. Perform the functional setting.
		Wrong setting (Selection of "without switch output")	Check if it can be set so that the switch output can be used.	Perform the functional setting.
		Product failure		Replace the product.
4	The output remains off. The indicator light works normally.	An unsuitable model selection	Check if PNP is being used even though the NPN was selected, or vice versa.	Review the selected model (output type).
		Opened lead wire	Check if there is bending stress being applied to any parts of the lead wire. (Bending radius and tensile force applied to the lead wire)	Modify the wiring conditions. (Adjust the tensile force and widen the bending radius.)
		Product failure		Replace the product.
5	The switch output generates chattering.	Incorrect wiring	Check the wiring. Confirm that the brown and blue wires are connected to DC(+) and DC(-) respectively, and that the output line has not become disconnected (contact failure).	Correct the wiring.
		Wrong setting	1. Check if the hysteresis range is too narrow. 2. Check if the response time is too short.	Perform the functional setting.
		Product failure		Replace the product.

Reference No.	Problem	Possible cause	Investigation method	Countermeasure
6	<ul style="list-style-type: none"> <li>●An over current error (Er1) is displayed.</li> <li>●A system error (Er4, 6, 7, 8) is displayed.</li> <li>●The display shows "HHH".</li> <li>●The display shows "LLL".</li> <li>●A residual pressure error (Er3) is displayed.</li> </ul>	Over current to the output (Er1)	<ol style="list-style-type: none"> <li>1. Check if a current of 80 mA or more is flowing to the output.</li> <li>2. Check whether the connected load is as specified, and confirm that there is no short circuit in the load.</li> <li>3. Check if a relay without a surge voltage suppressor is connected.</li> <li>4. Check if the wiring is in the same route as (or bundled together with) the high-voltage line or power line.</li> </ol>	<ol style="list-style-type: none"> <li>1. 2. Connect the load as specified.</li> <li>3. Change to a relay with a surge voltage suppressor or take measures to prevent noise.</li> <li>4. Separate the wiring from the high voltage line and power line.</li> </ol>
		Improper transaction of the internal data of the Pressure switch (Er4, 6, 7, 8)	<ol style="list-style-type: none"> <li>1. Confirm that there is no possibility of noise interference, such as static electricity.</li> <li>2. Confirm that the power supply voltage is in the range of 12 to 24 VDC<math>\pm</math>10%.</li> </ol>	<ol style="list-style-type: none"> <li>1. Remove the noise source or take measures to prevent noise interference and turn off the power supply. Then, turn the power supply on again.</li> <li>2. Supply an operating voltage of 12 to 24 VDC<math>\pm</math>10%.</li> </ol>
		Applied pressure over the upper limit (HHH)	<ol style="list-style-type: none"> <li>1. Confirm that the pressure is not over the upper limit of the set pressure range.</li> <li>2. Check if moisture such as water droplets has entered the inside of the piping.</li> </ol>	<ol style="list-style-type: none"> <li>1. Return the pressure to within the set pressure range.</li> <li>2. Take measures to prevent moisture from entering the piping.</li> </ol>
		Applied pressure under the lower limit (LLL)	<ol style="list-style-type: none"> <li>1. Confirm that the pressure is not over the upper limit of the set pressure range.</li> <li>2. Confirm if the moisture such as water drop has entered the inside of the piping.</li> </ol>	<ol style="list-style-type: none"> <li>1. Return the pressure within the set pressure range.</li> <li>2. Take the measure to prevent the moisture from entering to the piping.</li> </ol>
		The pressure is not atmospheric pressure for zero clear operation (Er3)	Check if the pressure difference is more than $\pm$ 10%F.S. from atmospheric pressure ( $\pm$ 0.11 MPa or more) when the zero clear operation is performed.	Return the applied pressure to atmospheric pressure and retry the zero clear operation.
		Product failure		Replace the product.
7	The values in the display fluctuate.	Incorrect power supply	Confirm that the power supply voltage is within the range of 12 to 24 VDC $\pm$ 10%.	Supply a power supply voltage of 12 to 24 VDC $\pm$ 10%.
		Incorrect wiring	Check the wiring to the power supply. Confirm that the brown and blue wires are connected to DC(+) and DC(-) respectively, and that the output line has not come off (contact failure).	Correct the wiring.
		Factory pressure change	Check if the factory pressure has changed.	If the fluctuation is worrisome, consider that a change in the response time correspondingly increases the interval for updating the display, and set the response time longer.

Reference No.	Problem	Possible cause	Investigation method	Countermeasure
8	<ul style="list-style-type: none"> <li>●The display turns off.</li> <li>●A part of the display misses.</li> </ul>	Improper power supply	Confirm that the power supply voltage is in the range of 12 to 24 VDC±10%.	Supply a power supply voltage of 12 to 24 VDC±10%.
		Power saving mode	Check if the power saving mode is selected.	Set functions.
		Incorrect wiring	Check the wiring for the power supply. Confirm that the brown and blue wires are connected to DC(+) and DC(-) respectively, and that the output line has not come off (contact failure).	Correct the wiring.
		Product failure		Replace the product.
9	The display is flashing.	Peak/bottom indication mode	Check if the peak indication mode or bottom indication mode has been selected.	Release the peak/bottom indication mode.
		Wiring failure	<ol style="list-style-type: none"> <li>1. Check the wiring to the power supply.</li> <li>2. Check if bending stress is being applied to part of the lead wire.</li> </ol>	<ol style="list-style-type: none"> <li>1. Correct the wiring.</li> <li>2. Modify the wiring (bending radius and stress).</li> </ol>
10	The display is inverted.	Selection of unsuitable model (Selection of wrong electrical entry)	Check the part number for the electrical entry.	Review the selected model.
		Change of indication mode	Check the selected indication mode.	Change the indication mode.
11	The indication accuracy of the pressure does not satisfy the specifications.	Intrusion of foreign matter	Check for the intrusion and attachment of foreign matter into the pressure port.	Install a 5µm filter to prevent the intrusion and attachment of the foreign matter. Also, exhaust the filter periodically to prevent drainage deposits.
		Air leakage	Check the air leakage from the mounted part. (Presence of the O-ring)	Rework the assembly process of the regulator. If the regulator is tightened at a torque over the specified range, its mounting screw could break. Also, remount the O-ring.
		Insufficient warming-up	Confirm that the specified accuracy is satisfied 20 min. after the power supply is turned on.	The figures in the display and output drift when the power supply is turned on. If fine pressure needs to be detected, wait approximate 20 to 30 min. after turning on the power supply to allow it to warm up.
		Product failure		Replace the product.

Reference No.	Problem	Possible cause	Investigation method	Countermeasure
12	The unit cannot be changed.	An unsuitable model selection (Selection of model "without unit change function")	Check for an "M" suffix on the part number on the name plate	"M" in the part number means that the unit cannot be changed. *: The new Measurement Law prohibits the use of Pressure switch with the unit conversion function in Japan. *: Fixed SI unit: MPa
		Product failure		Replace the product.
13	The buttons cannot be operated.	Key lock mode	Check if the key lock mode is selected.	Release the key lock mode.
		Product failure		Replace the product.
14	The body has become loose.	Incorrect installation	1. Confirm that the mounting adapter for the regulator is installed properly. 2. Confirm that the Pressure switch is installed to the mounting adapter properly.	Correct the mounting conditions.
		Product failure		Replace the product.
15	Noise.	Air leakage	Check for air leakage from the mounted part. (No mounted O-ring)	Rework the assembly of the regulator. If the regulator is tightened at a torque over the specified range, its mounting screw could break. Also, remount the O-ring.
		Product failure		Replace the product.
16	The operation is unstable.	Incorrect wiring	Check the wiring to the power supply. Confirm that the brown and blue wires are connected to DC(+) and DC(-) respectively, and that the output line has not come off (contact failure).	Correct the wiring.
		Opened lead wire	Check if there is bending stress applied to a certain part of the lead wire. (Bending radius and tensile force applied to the lead wire.)	Modify the wiring conditions. (Adjust the tensile force and widen the bending radius.)
		Product failure		Replace the product.



○Error indication function

This function is to display error location and content when a problem or an error occurs.

Error Name	Error Display	Error Type	Troubleshooting Method
Over current Error	Er 1	A load current of switch output is 80 mA or more.	Turn the power off and remove the output factor for the over current. Then turn the power on.
Residual pressure Error	Er 3	During zero clear operation, pressure over $\pm 10\%$ F.S. is applied. After 3 s, the mode will reset to the measurement mode. $\pm 1$ digit of the zero clear range varies with individual product differences.	Perform zero clear operation again after restoring the applied pressure to an atmospheric pressure condition.
Pressurizing Error	HHH	Pressure has exceeded the upper limit of the set pressure range.	Reset applied pressure to a level within the set pressure range.
	LLL	Pressure has exceeded the lower limit of the set pressure range.	
System Error	Er 4 Er 6 Er 7 Er 8	Displayed in the case of an internal data error.	Turn the power off and turn it on again. If resetting fails, an investigation by SMC Corporation will be required.

If the error can not be reset after the above measures are taken, then please contact SMC.

# Specification

## ■ Specifications

Model No.	ISE35	
Rated pressure range	0 to 1 MPa	
Set pressure range	-0.1 to 1 MPa	
Proof pressure	1.5 MPa	
Setting and display resolution	0.01 MPa	
Applicable fluids	Air, inert gases, and incombustible gases	
Power supply voltage	12 to 24 VDC $\pm 10\%$ with voltage ripple or less	
Current consumption	55 mA or less (With no load)	
Switch output	NPN or PNP open collector output	
	Max. load current	80 mA
	Max. applied voltage	30 V (During NPN output)
	Residual voltage	1 V or less (80 mA load current)
	Response time Chattering-proof function	1 s (0.25, 0.5, 2, 3 selectable)
	Short circuit protection	Provided
Repeatability	$\pm 1\%$ F.S.	
Hysteresis	Hysteresis mode	Variable (from 0)
	Window comparator mode	
Display method	3-digits 7-segment display, dual-color display (Red/Green), A switch can be operated simultaneously.	
Indication accuracy	$\pm 2\%$ F.S. $\pm 1$ digit (25 $\pm 3$ °C reference)	
Indicator light	OUT: LIT When ON (Green)	
Environment	Enclosure	IP40
	Ambient temperature	-5 to 50 °C (No freezing)
Lead wire with connector (for option "L")	Oil resistance vinyl cabtyre cable 3 cores $\phi 3.4$ , 2 m Sectional area of conductor: 0.2 mm <sup>2</sup> (AWG25) Outside diameter of insulator: 1.12 mm	
Standard	CE marked (EMC directive/RoHS directive), UL/CSA	

## ■Dimensions

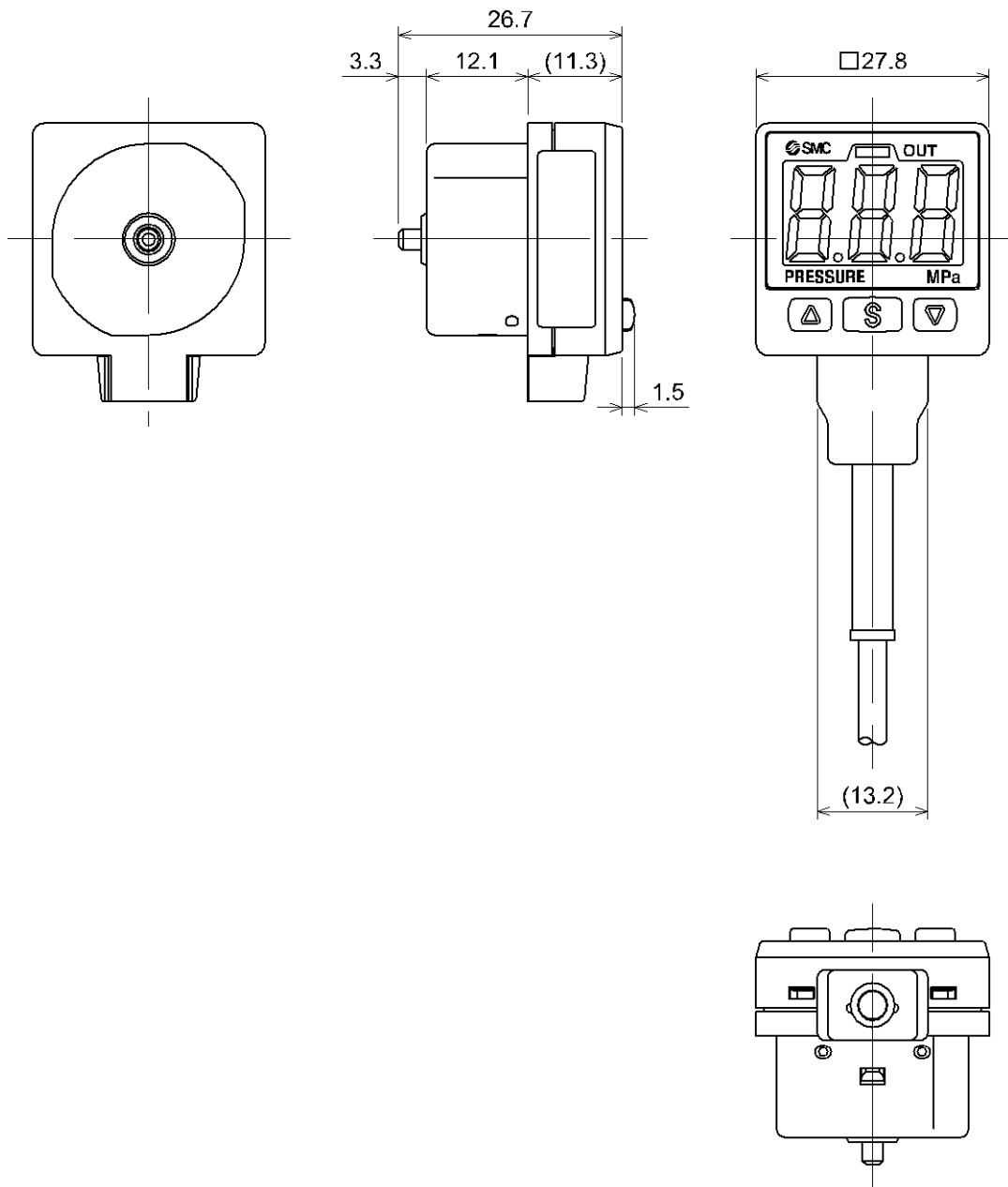

#### Revision history

A: Contents are added.  
B: Measurement laws are added.  
C: Modified errors in text.  
D: Contents revised in several places. [July 2018]  
E: Contents are added. [October 2019]

## SMC Corporation

4-14-1, Sotokanda, Chiyoda-ku, Tokyo 101-0021 JAPAN

Tel: + 81 3 5207 8249 Fax: +81 3 5298 5362

URL <https://www.smcworld.com>

---

Note: Specifications are subject to change without prior notice and any obligation on the part of the manufacturer.  
© 2007-2019 SMC Corporation All Rights Reserved

