



# Operation Manual

PRODUCT NAME

Multi-channel Digital Sensor Monitor  
( IO-Link compatible)

MODEL / Series / Product Number

*PSE202A-#*

*PSE203A-#*

**SMC Corporation**

## Table of Contents

Safety Instructions	2
Model Indication and How to Order	8
Summary of Product parts	9
Definition and terminology	11
Mounting and Installation	14
Installation	14
Wiring	16
Pressure Setting	20
Outline of Settings	21
Initial Setting	23
3 Step Setting Mode	27
Simple Setting Mode	29
Function Selection Mode	31
Function selection mode	31
Default setting	31
F 0 Differential pressure check mode, pressure range, display unit	33
F 1 Setting of OUT1	39
F 2 Setting of OUT2	42
F 3 Digital filter setting	44
F 4 Auto-preset function	45
F 6 Fine adjustment of display value	47
F10 Sub display setting	48
F11 Display resolution setting	54
F14 Zero cut-off setting	55
F80 Power saving mode	56
F81 Security code	57
F90 Setting of all functions	59
F95 Channel to channel copy function setting	61
F96 Sensor input display	62
F98 Output check	63
F99 Reset to default settings	70
Other Settings	71
IO-Link specifications	75
Outline of IO-Link function	75
Communication specifications	75
Process data	76
IO-Link parameter setting	83
Maintenance	96
Forgotten the security code	96
Troubleshooting	97
Specifications	107
Dimensions	110



# Safety Instructions

These safety instructions are intended to prevent hazardous situations and/or equipment damage. These instructions indicate the level of potential hazard with the labels of "Caution", "Warning" or "Danger". They are all important notes for safety and must be followed in addition to International Standards (ISO/IEC)\*1), and other safety regulations.

\*1) ISO 4414: Pneumatic fluid power -- General rules relating to systems.

ISO 4413: Hydraulic fluid power -- General rules relating to systems.

IEC 60204-1: Safety of machinery -- Electrical equipment of machines. (Part 1: General requirements)

ISO 10218: Manipulating industrial robots -Safety.

etc.



## Caution

**Caution** indicates a hazard with a low level of risk which, if not avoided, could result in minor or moderate injury.



## Warning

**Warning** indicates a hazard with a medium level of risk which, if not avoided, could result in death or serious injury.



## Danger

**Danger** indicates a hazard with a high level of risk which, if not avoided, will result in death or serious injury.

## Warning

### 1. The compatibility of the product is the responsibility of the person who designs the equipment or decides its specifications.

Since the product specified here is used under various operating conditions, its compatibility with specific equipment must be decided by the person who designs the equipment or decides its specifications based on necessary analysis and test results.

The expected performance and safety assurance of the equipment will be the responsibility of the person who has determined its compatibility with the product.

This person should also continuously review all specifications of the product referring to its latest catalog information, with a view to giving due consideration to any possibility of equipment failure when configuring the equipment.

### 2. Only personnel with appropriate training should operate machinery and equipment.

The product specified here may become unsafe if handled incorrectly.

The assembly, operation and maintenance of machines or equipment including our products must be performed by an operator who is appropriately trained and experienced.

### 3. Do not service or attempt to remove product and machinery/equipment until safety is confirmed.

1. The inspection and maintenance of machinery/equipment should only be performed after measures to prevent falling or runaway of the driven objects have been confirmed.

2. When the product is to be removed, confirm that the safety measures as mentioned above are implemented and the power from any appropriate source is cut, and read and understand the specific product precautions of all relevant products carefully.

3. Before machinery/equipment is restarted, take measures to prevent unexpected operation and malfunction.

### 4. Contact SMC beforehand and take special consideration of safety measures if the product is to be used in any of the following conditions.

1. Conditions and environments outside of the given specifications, or use outdoors or in a place exposed to direct sunlight.

2. Installation on equipment in conjunction with atomic energy, railways, air navigation, space, shipping, vehicles, military, medical treatment, combustion and recreation, or equipment in contact with food and beverages, emergency stop circuits, clutch and brake circuits in press applications, safety equipment or other applications unsuitable for the standard specifications described in the product catalog.

3. An application which could have negative effects on people, property, or animals requiring special safety analysis.

4. Use in an interlock circuit, which requires the provision of double interlock for possible failure by using a mechanical protective function, and periodical checks to confirm proper operation.



# Safety Instructions

## Caution

### **1. The product is provided for use in manufacturing industries.**

The product herein described is basically provided for peaceful use in manufacturing industries. If considering using the product in other industries, consult SMC beforehand and exchange specifications or a contract if necessary. If anything is unclear, contact your nearest sales branch.

## **Limited warranty and Disclaimer/Compliance Requirements**

The product used is subject to the following "Limited warranty and Disclaimer" and "Compliance Requirements".

Read and accept them before using the product.

### **Limited warranty and Disclaimer**

#### **1. The warranty period of the product is 1 year in service or 1.5 years after the product is delivered, whichever is first.\*2)**

Also, the product may have specified durability, running distance or replacement parts. Please consult your nearest sales branch.

#### **2. For any failure or damage reported within the warranty period which is clearly our responsibility, a replacement product or necessary parts will be provided.**

This limited warranty applies only to our product independently, and not to any other damage incurred due to the failure of the product.

#### **3. Prior to using SMC products, please read and understand the warranty terms and disclaimers noted in the specified catalog for the particular products.**

##### **\*2) Vacuum pads are excluded from this 1 year warranty.**

A vacuum pad is a consumable part, so it is warranted for a year after it is delivered.

Also, even within the warranty period, the wear of a product due to the use of the vacuum pad or failure due to the deterioration of rubber material are not covered by the limited warranty.

### **Compliance Requirements**

#### **1. The use of SMC products with production equipment for the manufacture of weapons of mass destruction (WMD) or any other weapon is strictly prohibited.**

#### **2. The exports of SMC products or technology from one country to another are governed by the relevant security laws and regulation of the countries involved in the transaction. Prior to the shipment of a SMC product to another country, assure that all local rules governing that export are known and followed.**

## Caution

### **SMC products are not intended for use as instruments for legal metrology.**

Products that SMC manufactures or sells are not measurement instruments that are qualified by pattern approval tests relating to the measurement laws of each country.

Therefore, SMC products cannot be used for business or certification ordained by the measurement laws of each country.

## Operator

- ◆ This operation manual is intended for those who have knowledge of machinery using pneumatic equipment, and have sufficient knowledge of assembly, operation and maintenance of such equipment. Only those persons are allowed to perform assembly, operation and maintenance.
- ◆ Read and understand this operation manual carefully before assembling, operating or providing maintenance to the product.

### ■ Safety Instructions

#### **Warning**

- Do not disassemble, modify (including changing the printed circuit board) or repair.  
An injury or failure can result.
- Do not operate the product outside of the specifications.  
Do not use for flammable or harmful fluids.  
Fire, malfunction, or damage to the product can result.  
Verify the specifications before use.
- Do not operate in an atmosphere containing flammable or explosive gases.  
Fire or an explosion can result.  
This product is not designed to be explosion proof.
- Do not use the product in a place where static electricity is a problem.  
Otherwise it can cause failure or malfunction of the system.
- If using the product in an interlocking circuit:
  - Provide a double interlocking system, for example a mechanical system
  - Check the product regularly for proper operationOtherwise malfunction can result, causing an accident.
- The following instructions must be followed during maintenance:
  - Turn off the power supply
  - Stop the air supply, exhaust the residual pressure and verify that the air is released before performing maintenanceOtherwise an injury can result.

## Caution

- Do not touch the terminals and connectors while the power is on.  
Otherwise electric shock, malfunction or damage to the product can result.
- After maintenance is complete, perform appropriate functional inspections and leak tests.  
Stop operation if the equipment does not function properly or there is a leakage of fluid.  
When leakage occurs from parts other than the piping, the product might be faulty.  
Disconnect the power supply and stop the fluid supply.  
Do not apply fluid under leaking conditions.  
Safety cannot be assured in the case of unexpected malfunction.

## ■ NOTE

- Follow the instructions given below when designing, selecting and handling the product.
  - The instructions on design and selection (installation, wiring, environment, adjustment, operation, maintenance, etc.) described below must also be followed.
    - \*Product specifications
      - Use the specified voltage.  
Otherwise failure or malfunction can result.
      - Use the specified pressure sensor.  
Otherwise the product may be broken and it will not be able to perform proper measurement.
      - Do not exceed the specified maximum allowable load.  
Otherwise it can cause damage or shorten the lifetime of the product.
      - Design the product to prevent reverse current when the circuit is opened or the product is forced to operate for operational check.  
Reverse current can cause malfunction or damage to the product.
      - Input data to the product is not deleted, even if the power supply is cut off.  
(Writing time: 10,000 times, Data duration: 20 years after power off)
      - Reserve a space for maintenance.  
Allow sufficient space for maintenance when designing the system.

## ●Product handling

### \*Installation

- Tighten to the specified tightening torque.

If the tightening torque is exceeded the mounting screws and brackets may be broken.

If the tightening torque is insufficient, the product can be displaced and loosen the mounting screws.

- Be sure to ground terminal FG when using a commercially available switch-mode power supply.
- Do not drop, hit or apply shock to the product.

Otherwise damage to the internal parts can result, causing malfunction.

- Do not pull the lead wire forcefully, not lift the product by pulling the lead wire.

(Tensile strength: 50 N maximum for power supply and output cable, 25 N maximum for sensor lead wire with connector).

Hold the body when handling to avoid the damage of the product which lead to cause the failure and malfunction.

- Never mount the product in a place that will be used as a scaffold during piping.

The product may be damaged if excessive force is applied by stepping or climbing onto it.

### \*Wiring

- Do not pull the lead wires. In particular, do not lift or carry the product by holding the cables once they are connected to the product.

Otherwise damage to the internal parts can result, causing malfunction or to be off the connector.

- Avoid repeatedly bending or stretching the lead wire, or placing heavy load on them.

If the lead wire can move, fix it near the body of the product.

The recommended bend radius of the lead wire is 6 times the outside diameter of the sheath, or 33 times the outside diameter of the insulation material, whichever is larger.

Replace the damaged lead wire with a new one.

- Wire correctly.

Incorrect wiring can break the product.

- Do not perform wiring while the power is on.

Otherwise damage to the internal parts can result, causing malfunction.

- Do not route wires and cables together with power or high voltage cables.

Otherwise the product can malfunction due to interference of noise and surge voltage from power and high voltage cables to the signal line. Route the wires (piping) of the product separately from power or high voltage cables.

- Confirm proper insulation of wiring.

Poor insulation (interference from another circuit, poor insulation between terminals, etc.) can lead to excess voltage or current being applied to the product, causing damage.

- Design the system to prevent reverse current when the product is forced to operate for operational check.

Depending on the circuit used, insulation may not be maintained when operation is forced, allowing reverse current to flow, which can cause malfunction and damage the product.

- Keep wiring as short as possible to prevent interference from electromagnetic noise and surge voltage.

Do not use a cable longer than 20 m.

Wire the DC(-) line(blue) as close as possible to the power supply.

### \*Environment

- Do not use the product in area that is exposed to corrosive gases, chemicals, sea water, water or steam.

Otherwise failure or malfunction can result.

- Do not use the product in an environment where the product is constantly exposed to water or oil splashes.

If the product is to be used in an environment containing oils or chemicals such as coolant or cleaning solvent, it may be adversely affected (damage, malfunction, or hardening of the lead wires).

- Do not use in an area where surges are generated.

If there is equipment which generates a large amount of surge (solenoid type lifter, high frequency induction furnace, motor, etc.) close to the product, this may cause deterioration or breakage of the internal circuit of the product. Avoid sources of surge generation and crossed lines.

- Do not use a load which generates surge voltage.  
When a surge-generating load such as a relay or solenoid is driven directly, use a product with a built-in surge absorbing element.
- The product is CE marked, but not immune to lightning strikes. Take measures against lightning strikes in the system.
- Mount the product in a place that is not exposed to vibration or impact.  
Otherwise failure or malfunction can result.
- Prevent foreign matter such as remnant of wires from entering the product.  
Take proper measures for the remnant not to enter the product in order to prevent failure or malfunction.
- Do not use the product in an environment that is exposed to temperature cycle.  
Heat cycles other than ordinary changes in temperature can adversely affect the inside of the product.
- Do not expose the product to direct sunlight.  
If using in a location directly exposed to sunlight, shade the product from the sunlight.  
Otherwise failure or malfunction can result.
- Keep within the specified ambient temperature range.  
The ambient temperature range is 0 to 50 °C. Operation at low temperature (5 °C or less) may cause damage or operation failure due to frozen moisture in the air.  
Protection against freezing is necessary.  
Avoid sudden temperature change even within specified temperature.
- Do not operate close to a heat source, or in a location exposed to radiant heat.  
Otherwise malfunction can result.

#### \*Adjustment and Operation

- Turn the power on after connecting a load.  
Otherwise it can cause excess current causing instantaneous breakage of the product.
- Do not short-circuit the load.  
Although error is displayed when the load at the output part has a short circuit, generated over current may lead to the damage of the product.
- Do not press the setting buttons with a sharp pointed object.  
It may damage the setting buttons.
- If using the product to detect very small pressure rates, warm up the product for 10 to 15 minutes first.  
There will be a drift on the display of approximate  $\pm 1\%$  immediately after the power supply is turned on, within 10 minutes.
- Perform settings suitable for the operating conditions.  
Incorrect setting can cause operation failure.  
For details of each setting, refer to page 20 to 74 of this manual.
- Do not touch the LCD during operation.  
The display can vary due to static electricity.

#### \*Maintenance

- Turn OFF the power supply before maintenance.  
There is a risk of unexpected malfunction.
- Perform regular maintenance and inspections.  
There is a risk of unexpected malfunction.
- Do not use solvents such as benzene, thinner etc. to clean the product.  
They could damage the surface of the body and erase the markings on the body.  
Use a soft cloth to remove stains. For heavy stains, use a cloth soaked with diluted neutral detergent and fully squeezed, then wipe up the stains again with a dry cloth.



# Model Indication and How to Order

PSE20 **2** A- **M**

I/O specification

Symbol	Content
2	IO-Link/NPN 1 output + NPN 4 outputs
3	IO-Link/PNP 1 output + PNP 4 outputs

Unit specification

Symbol	Content
Nil	With units selection function *1
M	Fixed SI unit *2

\*1: The new Measurement Law prohibits the use of pressure switch with the units selection function in Japan. A unit label is attached.

\*2: Fixed unit kPa, MPa, Pa

Option 3

Symbol	Content
Nil	Power supply/output cable (2 m)
N	No option

\*5: Cable is shipped together with the product.

Option 2

Symbol	Content
Nil	No option
4C	Connector for sensor lead wire (4 pcs.)

\*4: Connector is shipped together with the product.

Option 1

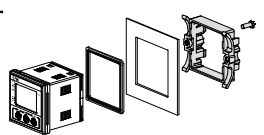
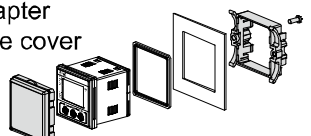
Symbol	Content
Nil	No option
A	Panel mount adapter 
B	Panel mount adapter + Front protective cover 

\*3: Option is shipped together with the product.

## ○Accessories/Part numbers

Items	Part No.	Remarks
Power supply/output cable	ZS-26-L	Length 2 m
Connector for sensor lead wire	ZS-28-C	1 pc.
Panel mount adapter	ZS-26-B	With set screw M3 x 8L (2 pcs.) and waterproof seal
Panel mount adapter + Front protective cover	ZS-26-C	With set screw M3 x 8L (2 pcs.) and waterproof seal
Front protective cover	ZS-26-01	-
□48 conversion adapter	ZS-26-D	It is an adapter for attaching PSE200A series in the panel cut size of PSE100 series.

## Summary of Product parts

### Names of individual parts

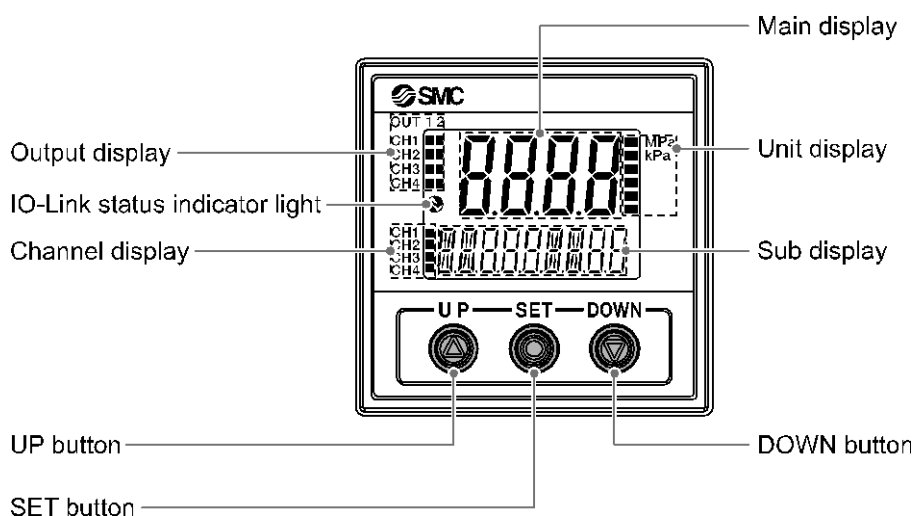

Output display (Orange): Lit when OUT is ON.

Main display (Red/Green): Displays the current status of pressure, setting mode, selected indication unit and error code.

UP button: Selects the channel and mode, and increases the ON/OFF set value.

DOWN button: Changes the sub display, selects the mode and decreases the ON/OFF set value.

SET button: Changes the mode and sets a set value.

Unit display (Red/Green): Lit ON the indicator of selected unit. For the Controller without unit selection function, the unit is fixed to SI (MPa, kPa or Pa).

Unit label: Attach the unit label (kgf/cm<sup>2</sup>, bar, psi, inHg, mmHg, Pa, mbar, mmH<sub>2</sub>O) with a unit selection function.

LCD of corresponding unit turns on as follows:

■ MPa	When MPa is selected
■ kPa	When kPa is selected
■	When kgf/cm <sup>2</sup> is selected
■	When bar is selected
■	When psi is selected
■	When unit other than above is selected





Channel display (Orange): Indicate the CH1 to CH4 that is selected at that time.

Sub display (left) (Orange): Displays items.

Sub display (right) (Orange): Displays set values, peak and bottom values.

IO-Link status indicator light: Displays OUT1 output communication status (SIO mode, start-up mode, Pre-operation mode, operation mode) and presence of communication data.

●IO-Link indicator light operation and display

Communication with master	IO-Link status indicator light	Status			Sub screen display *1	Content
						
Yes		IO-Link mode	Correct	Operate	ModE oPE	Normal communication status (Reading of measurement value)
				Start up	ModE StPt	When communication starts up.
				Preoperate	ModE PrE	
			Abnormal	Version does not match	Er 15 V 1.0	Version of master and IO-Link does not match *2
				Lock	ModE LoL	Back-up and re-store required due to data storage lock
No			Communication shut-off	ModE StPt ModE PrE ModE oPE	Correct communication was not received for 1 second or more.	
			SIO mode	ModE SIO	General switch output	

LCD display: "O" OFF, "" Flashing, "" ON

\*1: "ModE - - -" is displayed when selecting the modes on the sub screen.

\*2: When the product is connected to the master with version "V1.0", error Er15 is generated.

## ■ Definition and terminology

	Term	Definition
A	Auto-preset	Performs pressure setting automatically by detecting the increase and decrease in pressure. For example, if this function is used for a suction test, the pressure setting will be completed by performing suction and release of the workpiece.
B	Bottom value display (mode)	Shows the minimum pressure from when the power was supplied to the current time.
C	Chattering	The problem of the switch output turning ON and OFF repeatedly around the set value at high frequency due to the effect of pulsation.
	Chattering prevention function	A function to delay the response time of switch output in order to prevent chattering.
D	Delay time	The setting time from when the input signal reaches the set value, to when the ON-OFF output actually begins working. Delay time setting can prevent the output from chattering. The response time indicates when the set value is 90% in relation to the step input.
	digit (Min. setting unit)	Shows how precisely the pressure can be displayed or set. When 1 digit = 1 kPa, the pressure is displayed in increments of 1 kPa, e.g., 1, 2, 3, ..., 99, 100.
	Digital filter	Function to add digital filtering to the fluctuation of input value. Smooth the fluctuation of displayed value for sharp start up or fall of the pressure. When the function is valid, digital filtering is reflected to the ON/OFF of the switch output. Output chattering or flicker in the measurement mode display can be reduced by setting the digital filter.
	Display accuracy	Shows The maximum deviation between the displayed pressure value and the true pressure.
	Display colour	Indicates the colour of the number of digital display. Always green, always red, green (switch OFF) → red (switch ON), red (switch OFF) → green (switch ON) are available.
	Display resolving power	Indicate in how many the rated pressure range can be divided to display. (Example: When the value can be displayed down to 0.001 MPa for the product for 0 to 1 Mpa, the resolution is 1/1000)
	Display value fine adjustment (function)	Displayed pressure value can be adjusted within the range of $\pm 5\%$ R.D. ( $\pm 5\%$ of displayed value). It is used if the true pressure value is known, or to eliminate differences between the displayed values of different instruments that are measuring the same pressure.
E	Error displayed	A code number displayed to identify the error code detected by the self-diagnostic function of the product. Refer to "Error indication function" on page 106 for details of the errors.
	Error output	Switches the switch output to ON/OFF when an error is displayed. Refer to "List of output modes" on page 41 for operating conditions. Refer to "Error indication function" on page 106 for details of the errors.

	Term	Definition
F	F.S. (full span/full scale)	Abbreviation of full span and full scale; difference between the minimum and maximum rated pressure values. means the maximum fluctuation range of the pressure switch rated value. For example, when the rated pressure range is -0.100 to 1.000 [MPa]: F.S. = 1.000 - (-0.100) = 1.100 [MPa] (Reference: 1%F.S. = 1.100 x 0.01 = 0.011 [MPa])
	Fine adjustment mode	Refer to "Display value fine adjustment (function)".
	Fluid contact part (or wetted part)	Part of the product which contacts detected fluid. Pressure sensor, seal and fitting are included.
	Function selection mode	A mode in which setting of functions is performed. It is a separate menu from the pressure setting. If any function settings need to be changed from the factory default, each setting can be selected with "F*". The setting items are: display colour, operation mode, output type, digital filter, display resolution, display value fine adjustment, use of auto preset, use of power saving mode, security code, etc.
H	Hysteresis	Difference between the ON and OFF points of switch output.
	Hysteresis mode	Refer to the "List of output modes" on page 41.
I	Insulation resistance	Insulation resistance of the product. The resistance between the electrical circuit and the case.
K	Key-lock function	Function that prevents changes to the settings of the product (disables button operation).
M	Manual setting	Manual pressure setup without using auto preset. This term is used to distinguish between manual and auto preset pressure setup.
	Maximum applied voltage	The maximum voltage that can be connected to the output of an NPN device.
	Maximum load current	The maximum current that can flow to the output (output line) of the switch output.
	Measurement mode	Operating condition in which pressure is being detected and displayed, and the switch function is working.
	Min. setting unit	Refer to "digit".
N	Normal output	One of the switch output types. In hysteresis mode the switch output is turned ON when pressure equal to or greater than the switch output set value is detected. In window comparator mode, the switch output is turned ON when pressure between the switch output set values (P1L to P1H) is detected. (Refer to the "List of output modes" on page 41.)
O	Operation light	A light that turns on when the switch output is ON.
	Operation mode	Either hysteresis mode or window comparator mode can be selected.
	Output style	The operation principle of the switch output. Normal output and reverse output can be selected. Please refer to the "List of output modes" on page 41 operating conditions.

	Term	Definition
P	Peak value display (mode)	Shows the maximum pressure from when the power was supplied to the current time.
	Port size	The diameter of the connecting part of the product for connecting with the object to be measured.
	Power saving mode	Operating mode in which the digital display turns off and power consumption is reduced.
	Pressure setting	The set pressure value that determines the point at which the switch output turns ON and OFF.
	Proof pressure	Pressure limit that if exceeded will result in mechanical and/or electrical damage to the product.
R	R.D.	Current read value For example, when the display value is 1.000[MPa], $\pm 5\%$ R.D. is $\pm 5\%$ of 1.000[MPa], which becomes $\pm 0.05$ [MPa]. When the display value is 0.800[MPa], $\pm 5\%$ R.D. is $\pm 5\%$ of 0.800[MPa], which becomes $\pm 0.04$ [MPa].
	Rated pressure range	The pressure range within which the product will meet all published specifications. Values outside of this range can be set as long as they are within the set pressure range, but the specifications cannot be guaranteed.
	Repeatability	Variation in repeated measurement of pressure display or ON-OFF output point when the pressure changes at 25 centigrade.
	Residual voltage	The difference between the ideal ON voltage and the actual voltage when the switch output is on. Varies with load current. Ideally should be 0 V.
	Resolution	Refer to "Display resolution".
	Reversed output	One of the switch output types. In hysteresis mode the switch output is turned ON when pressure less than or equal to the switch output set value is detected. In window comparator mode, the switch output is turned ON when pressure is outside the switch output set values (n1L to n1H) is detected. (Refer to the "List of output modes" on page 41.)
	Ripple	A type of chattering.
S	Set pressure range	The pressure range that can be set for switch output.
	Switch output	Sometimes referred to as "ON-OFF output".
U	Units selection function	A function to change the units in which the measured pressure value is displayed. The display units can only be changed if the product is equipped this function. It is not possible to purchase the product with this function if the product is used in Japan. The product for Japan is displayed in SI only.
W	Window comparator mode	An operating mode in which the switch output is turned on and off depending on whether the flow is inside or outside the range of two set values. (Refer to the "List of output modes" on page 41.)
	Withstand voltage	A measure of the product's resistance to a voltage applied between the electrical circuit and case. Durability in withstanding voltage. The product may be damaged if a voltage over this value is applied. (The withstand voltage is not the supply voltage used to power the product.)
Z	Zero-clear function	This function to adjust the displayed pressure to zero.

# Mounting and Installation

## ■ Installation

### ○ Mounting by panel mount adapter

- Fix the panel mount adapter to the Controller with the set screws M3 x 8L (2 pcs.) as attached.

- Panel mount adapter (Model: ZS-26-B)

Panel mount adapter + Front protective cover (Model: ZS-26-01)

- 48 conversion adapter (Model: ZS-26-D)

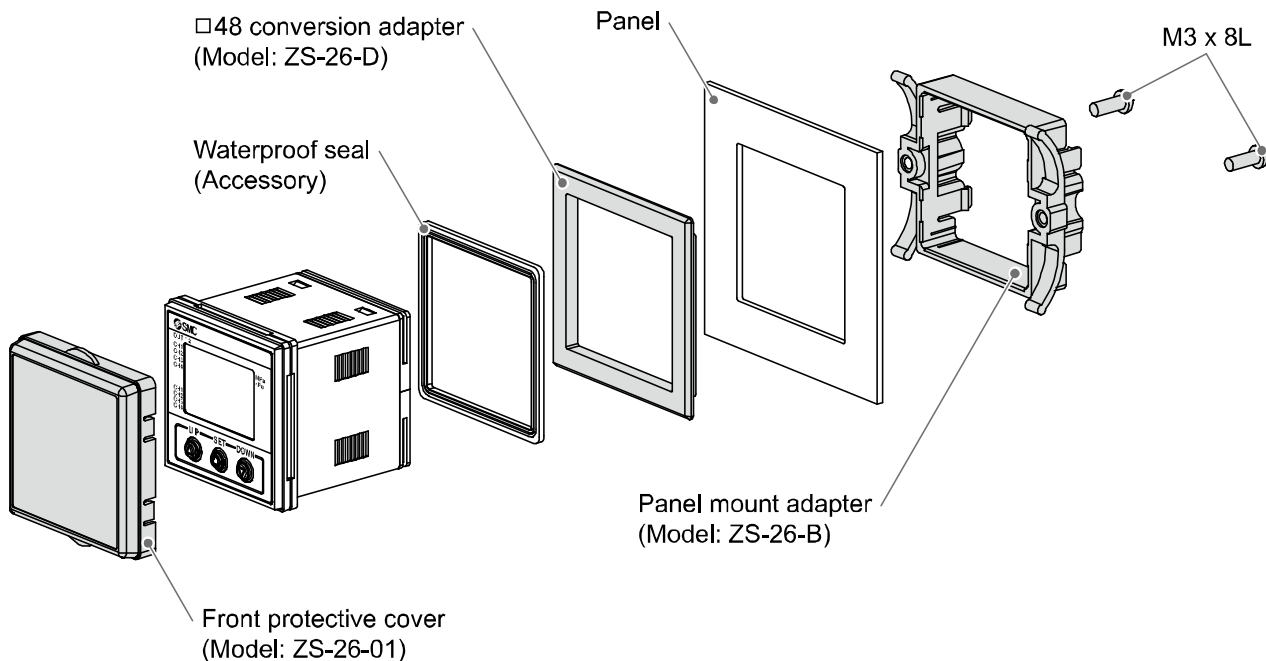

\*: The panel mount adapter can be rotated by 90 degrees for mounting.

\*: Front panel of this Controller meets IP65 (if □48 conversion adapter is used, it meets IP40). However, if the panel mount adapter is hold enough with screw and the instrument is not seated correctly, water might enter. Screw shall be tightened 1/4 to 1/2 turns more after touched correctly.

### ○ Panel cutout dimension

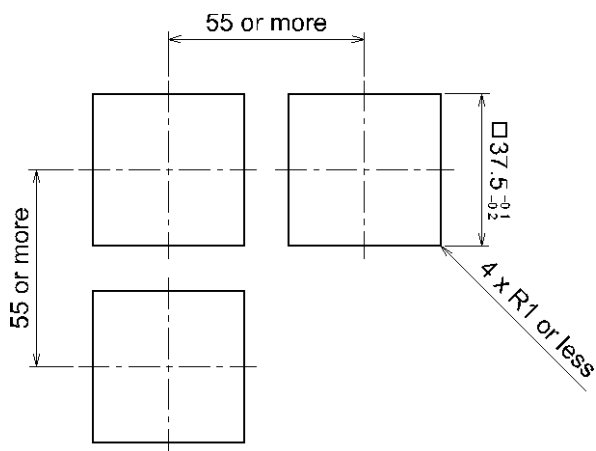

\*: Panel thickness 0.5 to 8 mm

#### Notice when removing to the controller

- The Monitor with the panel mount adapter can be removed from facility after removing two screws as shown in a figure, by making insert the suitable thin card for the hook of both the sides, pull a panel mount adapter to the front, and remove it. If panel mount adapter is drawn forward with hook caught, the adapter and Monitor may be damaged.

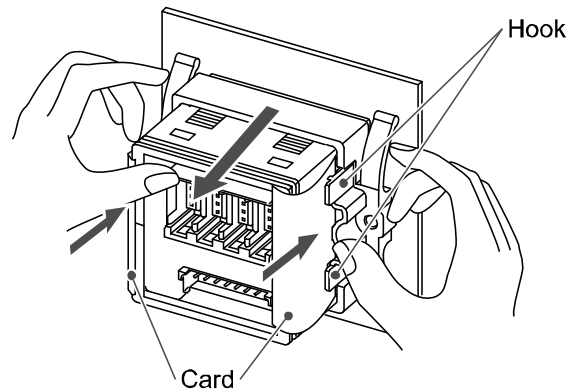



## ■Wiring

### ○Wiring connections

- Connections should be made with the power supply turned off.
- Use a separate route for the product wiring and any power or high voltage wiring. Otherwise, malfunction may result due to noise.
- If a commercially available switching power supply is used, be sure to ground the frame ground (FG) terminal. If the switching power supply is connected for use, switching noise will be superimposed and it will not be able to meet the product specifications. In that case, insert a noise filter such as a line noise filter/ferrite between the switching power supplies or change the switching power supply to the series power supply.

### ○Attaching the connector to the lead wire

- Sensor wire is stripped as shown in the right figure.  
(Refer to the table below for correspondence between connector and electrical wire gauge.)

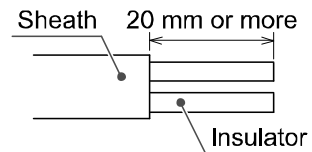

Lead wire table

AWG No.	Conductor size (mm <sup>2</sup> )	Overall diameter (mm)	Colour of cover	SMC product No. (1 pc.)
26-24 (28)	0.14-0.2 (0.08)	φ0.8 to φ1.0	Red	ZS-28-C
		φ1.0 to φ1.2	Yellow	ZS-28-C-1
		φ1.2 to φ1.6	Orange	ZS-28-C-2
22-20	0.3-0.5	φ1.0 to φ1.2	Green	ZS-28-C-3
		φ1.2 to φ1.6	Blue	ZS-28-C-4
		φ1.6 to φ2.0	Gray	ZS-28-C-5

- Do not cut the insulator.
- The core of the corresponding colour shown in the following table is put into the pin of the number stamped on the connector for sensor connection to the back.

Pin No.	Wire colour
1	Brown (DC+)
2	NC
3	Blue (DC-)
4	Black (IN: 1 to 5 V)

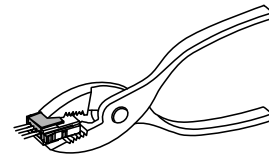
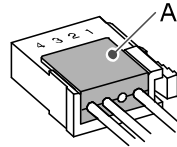

- Check that the above-mentioned preparation work has been performed correctly, and part A shown in the figure is pushed by hand and makes temporary connection.
- Part A centre is pushed straight in using a suitable tool, such as pliers.
- Re-use cannot be performed once it connects the connector for sensor connection completely. When the connection fails or a pin is miswired, please use a new connector for sensor connection.
- When the sensor is not connected correctly, [LLL] will be displayed.
- Cable wire colour is applicable when an SMC sensor with lead wire is used.

○Connector

**Connecting/Disconnecting**

- When connecting the connector, insert it straight onto the pin and lock the connector into the square groove in the housing until connector clicks.
- When removing the connector, press down the lever with your thumb and pull the connector straight out.

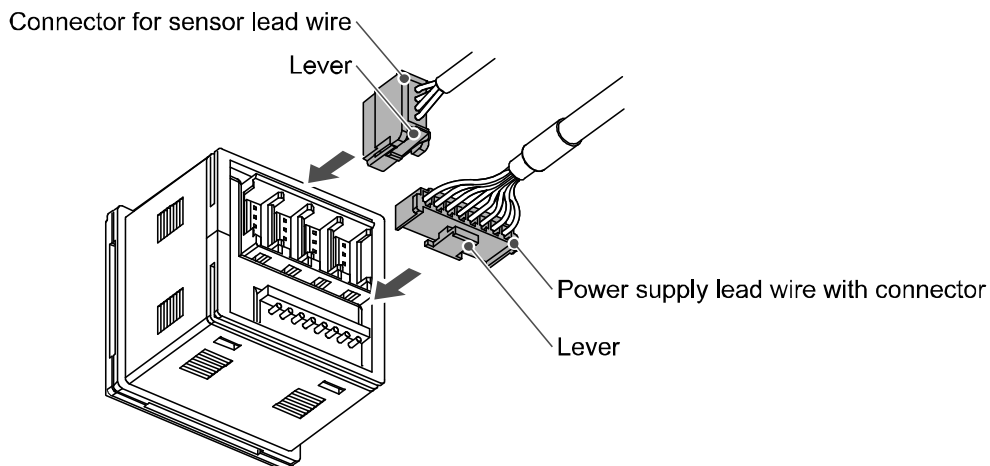

**Pin No. of the connector**

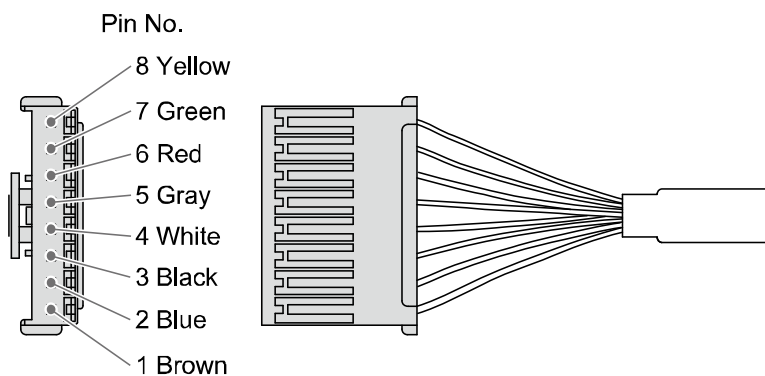

PIN number	Terminal name
1	L+
2	L-
3	C/Q (CH1_OUT1)
4	CH1_OUT2
5	CH2_OUT1
6	CH3_OUT1
7	CH4_OUT1
8	N.C.

■ Internal circuit and wiring example

○ Output specification

When the lead wire with SMC power and output lead wire (Model: ZS-26-L) is used, the colours of wire (Brown, Blue, White, Gray, Red, Green Yellow) will apply as shown on circuit diagram.

**PSE202A-(M)#**

•IO-Link/NPN open collector 1 output + NPN open collector 4 output specification

•When used as an IO-Link device

Max. 30 V, 80 mA

Residual voltage 1.5 V or less

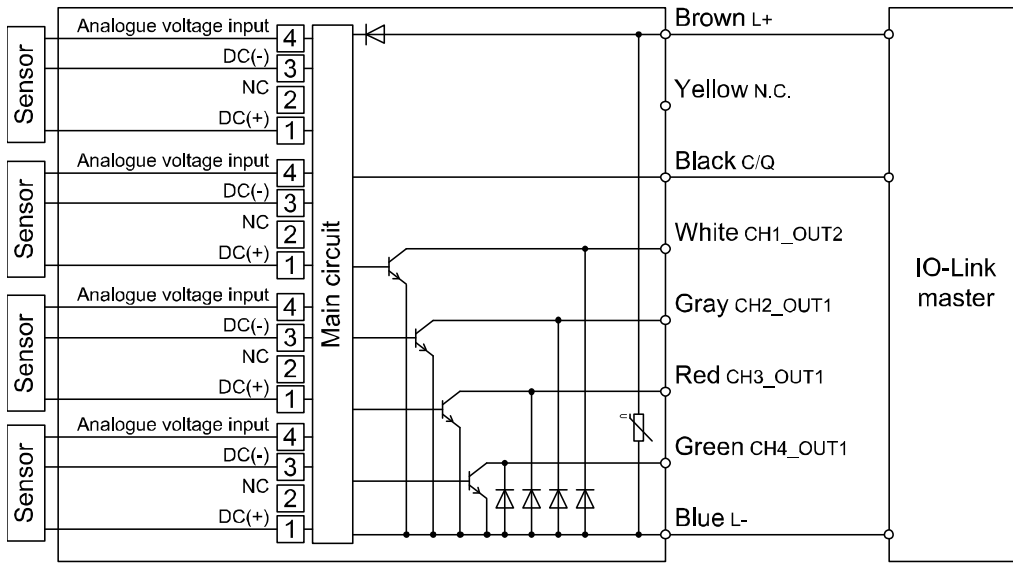

•When used as a switch output device

Max. 80 mA

Residual voltage 1.5 V or less

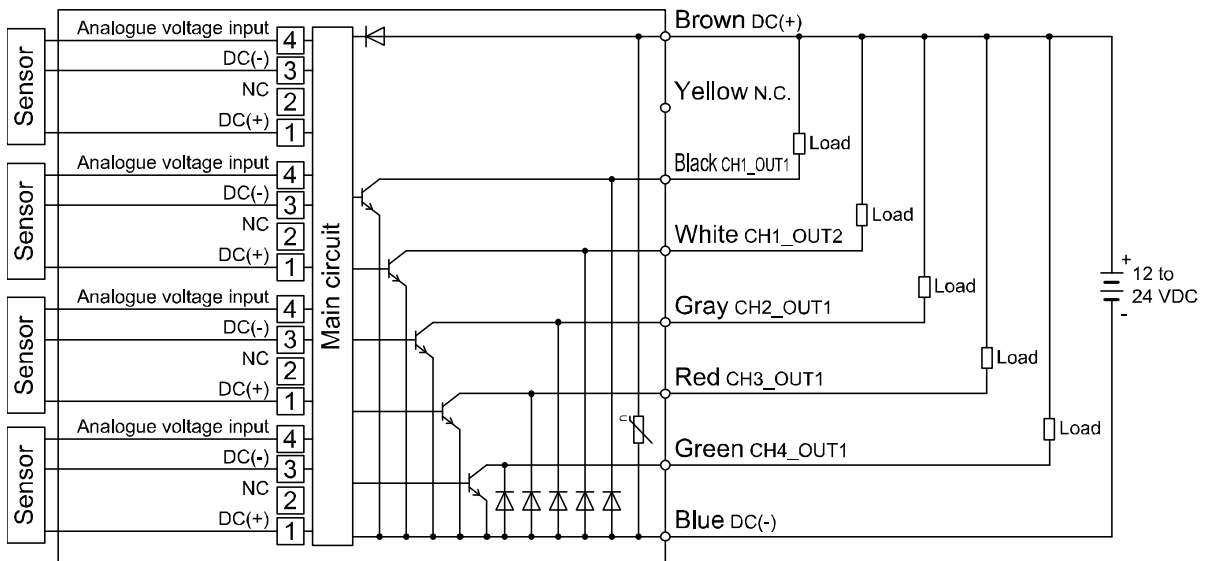

**PSE203A-(M)#**

**•IO-Link/PNP open collector 1 output + PNP open collector 4 output specification**

•Used as IO-Link device

Max. 30 V, 80 mA

Residual voltage 1.5 V or less

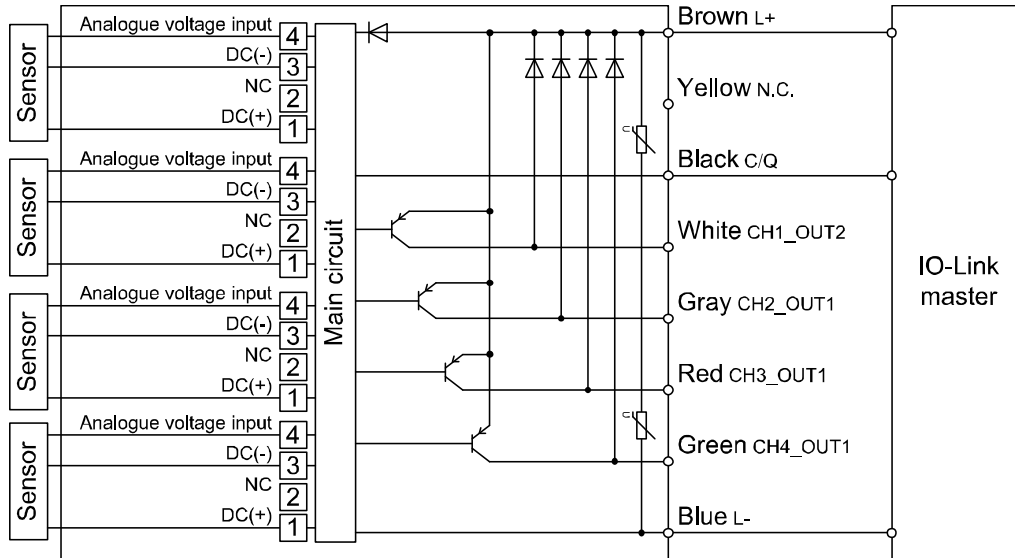

•When used as a switch output device

Max. 80 mA

Residual voltage 1.5 V or less

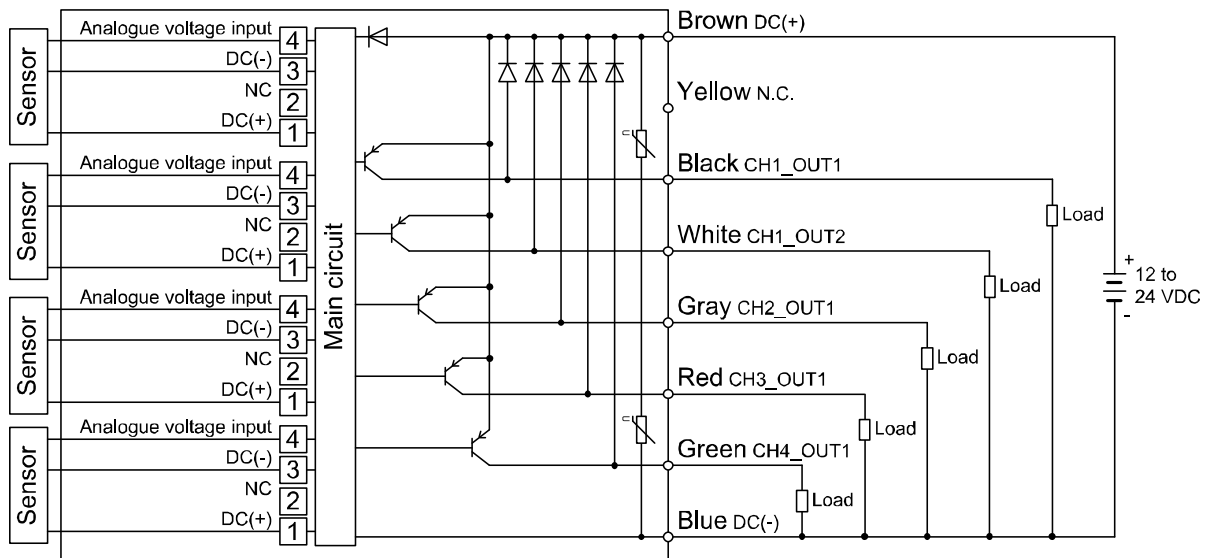

## Pressure Setting

### Default settings

When the pressure exceeds the set value, the switch will be turned on.

When the pressure falls below the set value by the amount of hysteresis or more, the switch will be turned off.

The default setting is that the output is turned ON at -50.5 kPa when the pressure range of the connected sensor is vacuum.

Perform initial setting by referring to the setting outline (page 21).

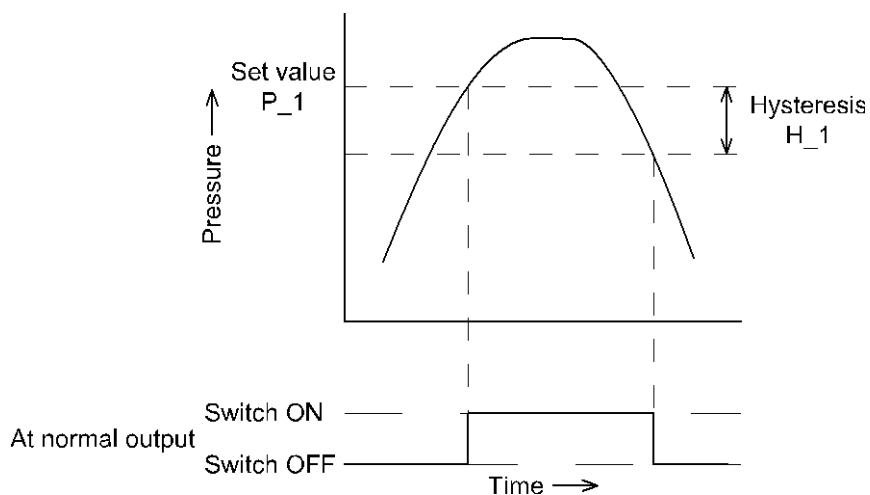

### Zero-clear of display

The display is reset to zero when the UP and DOWN buttons are pressed simultaneously for 1 second. For the first operation, perform a zero-clear without pressure at measurement mode.

Zero-clear function ➡ Page 72

## Outline of Settings

### Power is supplied



The product code is displayed for approximately 3 sec. after supplying power.  
After that, measurement mode is displayed.

\*: Within approximately 0.2 second after power-on, the switch starts.



### [Initial Setting]

(Function selection mode [F 0]) (Refer to page [23](#))

Set the differential pressure check mode, pressure range, and display unit of the connected sensor.





## [Measurement mode]

Detects the pressure after power is supplied, and indicates the display and switch operating status. This is the basic mode; other modes should be selected for set-point changes and other function settings.

### Measurement mode screen

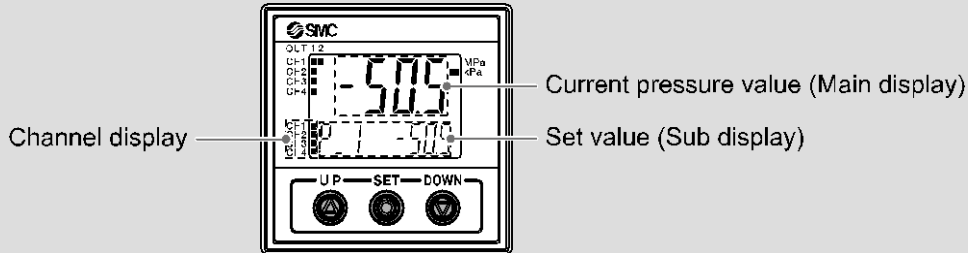

### Channel selection

In measurement mode, the channel can be changed by pressing the UP button.

**Measurement mode display and setting are set for each channel.**

### Normal operation mode

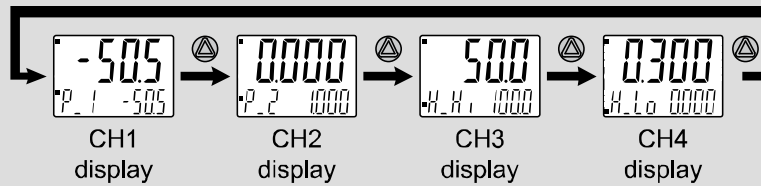

### Differential pressure check mode

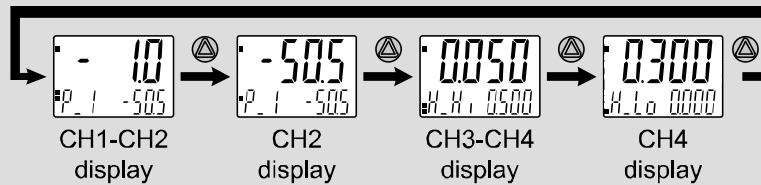

Press the SET button once.



Press the SET button between 1 and 3 sec.



Press the SET button between 3 and 5 sec.



Press the DOWN button once.



### [3 step setting mode]

Set either of set value or hysteresis.  
(Refer to page 27)

### [Simple setting mode]

Select the set value, hysteresis and delay time.  
(Refer to page 29)

### [Function selection mode]

Change the function settings.  
(Refer to page 31)

### [Sub display setting]

(Refer to page 49)

### [Other Settings]

- Channel scan function
- Zero-clear function
- Key-lock function (Refer to page 71)

\*: The outputs will continue to operate during setting.

\*: If a button operation is not performed for a certain time during the setting, the display will flash.

(This is to prevent the setting from remaining incomplete if, for instance, an operator were to leave during setting.)

\*: 3 step setting mode, simple setting mode and function selection mode settings are reflected each other.

## Initial Setting

Set the differential pressure check mode, pressure range, and display unit of the connected sensor.

Measurement mode



Press the UP button to select the channel.  
Press the SET button between 3 and 5 sec.

[F0] Displays differential pressure check mode, pressure range and display unit.



Press the SET button.



Move on to the setting of differential pressure check mode.

### Differential pressure check mode setting (Setting common for all channels)

Set and display the differential pressure between CH1 - CH2, and CH3 - CH4.

Press the UP button to select the differential pressure check mode.

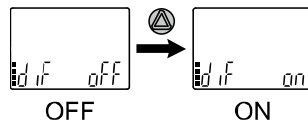
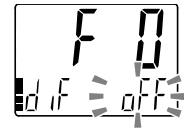

Press the SET button.



Move on to pressure range setting.





### Pressure range setting

Press the UP or DOWN button to select pressure range.

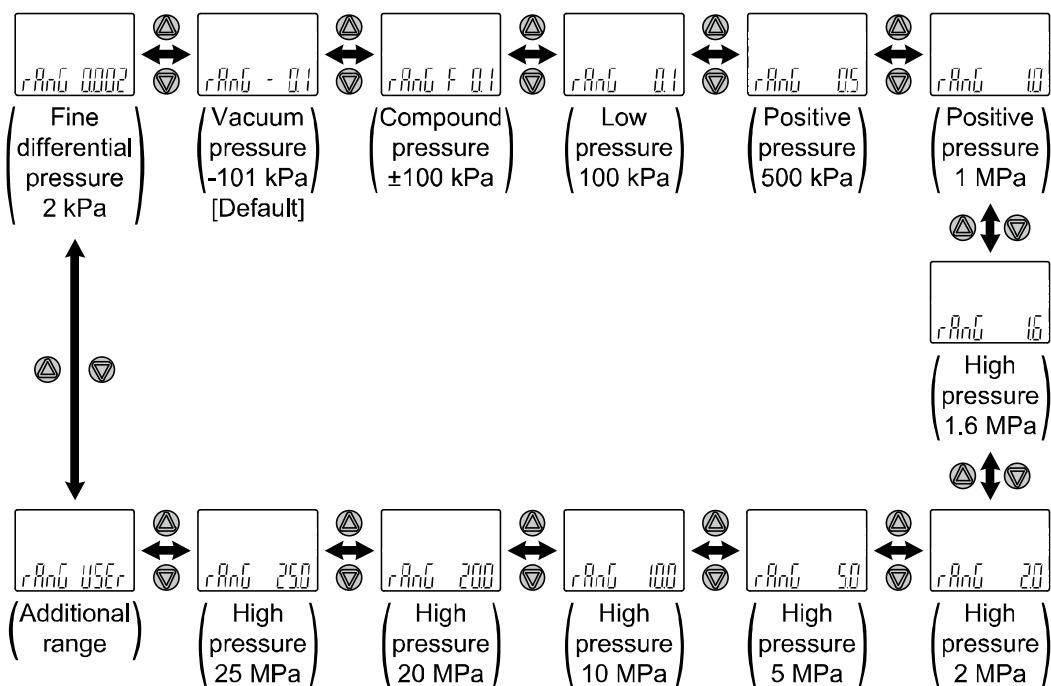

**[USER] is selected.**  
 Press the SET button to move on to the setting of the minimum unit of the additional range.

### Additional range minimum unit setting

Press the UP or DOWN button to select the minimum unit.

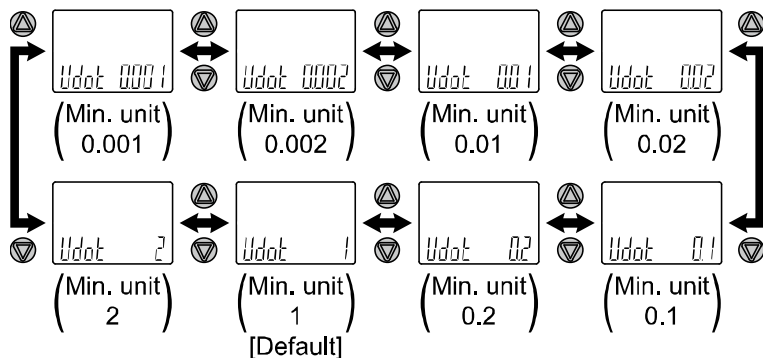

Press the SET button to set.

Move on to the setting of the lower limit of the additional rated range.  
 The lower limit of the rated range is the displayed value when the sensor input signal is 0%.

Other than [USER] is selected.  
 Press the SET button to move on to display unit setting.

**Setting of the lower limit of the additional rated range**

Press the UP or DOWN button to change the value.  
 Press the button continuously to keep changing the value.  
 Set the value that is required to be displayed when the sensor input signal is 0%.  
 The setting range is -1500 to 1500 digit.



\*: There is unsetting range. (Refer to page 38)

Press the SET button to set.

Move on to the setting of the upper limit of the additional rated range.  
 The upper limit of the rated range is the displayed value when the sensor input signal is 100%.

**Setting of the upper limit of the additional rated range**

Press the UP or DOWN button to change the value.  
 Press the button continuously to keep changing the value.  
 Set the value that is required to be displayed when the sensor input signal is 100%.  
 The setting range is -1500 to 1500 digit.

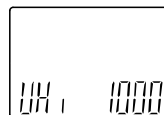

\*: There is unsetting range. (Refer to page 38)

Press the SET button to set. Move on to display unit setting.

**Display unit setting**

Press the UP or DOWN button to select the display unit.

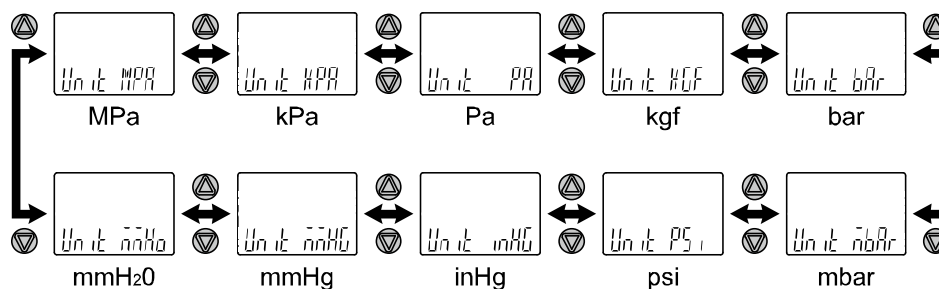
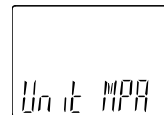

\*: The unit that can be displayed is different depending on the pressure range. (Refer to page 34)  
 (kPa/MPa/Pa can still be selected if the product does not have the units selection function.)  
 \*: Refer to page 9 for LCD of corresponding unit.

Press the SET button to set. Return to function selection mode.



↓

[F0] Setting of differential pressure check mode, pressure range and display unit is completed

↓ Press the SET button for 2 second or longer.

Measurement mode  
(Initial setting is completed)

↓

Perform the setting with the 3 step setting mode, simple setting mode and function selection mode.

## 3 Step Setting Mode

### 3 step setting mode

In this mode, the set values can be input in just 3 steps.

Use this mode if the product is to be used straight away, after changing only the set values.

(The current pressure value is displayed on the main display.)

#### <Operation>

[3 step setting mode (hysteresis mode)]

In the 3 step setting mode, the set value (P\_1 or n\_1, P\_2 or n\_2) and hysteresis (H\_1, H\_2) can be changed.

After selecting the channel, set the items on the sub display (set value or hysteresis) with the DOWN button.

When changing the set value, follow the operation below. The hysteresis setting can be changed in the same way.

- (1) Press the SET button once when the item to be changed is displayed on the sub display.  
The set value on the sub display (right) will start flashing.

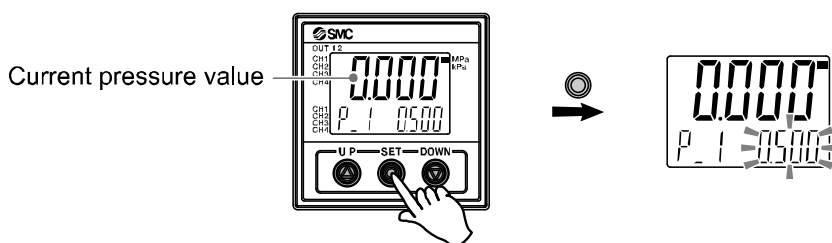

- (2) Press the UP or DOWN button to change the set value.  
The set value can be increased with UP button and can be reduced with DOWN button.

• Press the UP button once to increase the value by one digit, press and hold to continuously increase.

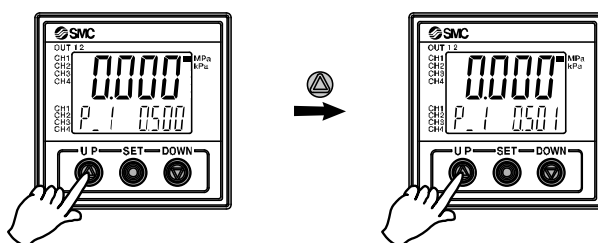

• Press the DOWN button once to reduce the value by one digit, press and hold to continuously reduce.

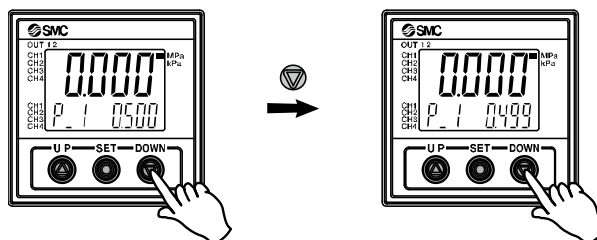

• When the UP and DOWN buttons are pressed and held simultaneously for 1 second or longer, the set value is displayed as [- -], and the set value will be the same as the current pressure value automatically (snap shot function (Refer to page 71)). Afterwards, it is possible to adjust the value by pressing the UP or DOWN button.

- (3) Press the SET button to complete the setting.

The product turns on within a set pressure range (OUT1: from P1L to P1H, OUT2: from P2L to P2H) during window comparator mode. Set P1L/P2L, the lower limit of the switch operation, and P1H/P2H, the upper limit of the switch operation and WH1/WH2 (hysteresis) following the instructions given on page 27. (When reversed output is selected, the sub display (left) shows [n1L]/[n2L] and [n1H]/[n2H].) Please refer to the "List of output modes" on page 41 for the relationship between the set values and operation.

\*: Setting of the normal/reverse output switching and hysteresis/window comparator mode switching are performed with the function selection mode [F 1] Setting of OUT1, [F 2] Setting of OUT2.

## Simple Setting Mode

### <Operation>

[Simple setting mode (hysteresis mode)]

In the simple setting mode, the set value, hysteresis and delay time can be changed while checking the current pressure value (main display).

- (1) After selecting the channel, press the SET button for 1 second or longer, but less than 3 seconds, in measurement mode. [SEt] is displayed on the main display. When the button is released while in the [SEt] display, the current pressure value is displayed on the main display, [P\_1] or [n\_1] is displayed on the sub display (left), and the set value is displayed on the sub display (right) (Flashing).

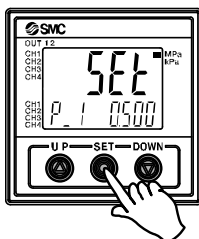

- (2) Change the set value with UP or DOWN button, and press the SET button to set the value. Then, the setting moves to hysteresis setting. (The snap shot function can be used. (Refer to page 71))

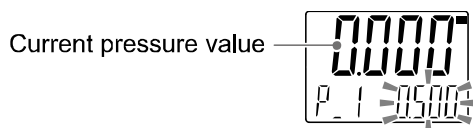

- (3) Change the set value with UP or DOWN button, and press the SET button to set the value. Then, the setting moves to the delay time of the switch output. (The snap shot function can be used. (Refer to page 71))



- (4) The delay time of the switch output can be selected by pressing the UP or DOWN button at the ON and OFF point of the switch output. Delay time setting can prevent the output from chattering. The delay time can be set in the range 0.00 to 60.00 sec. in 0.01 sec. increments.

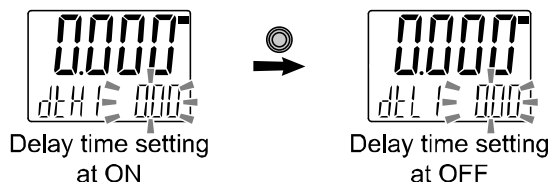

- (5) Press the SET button for 2 seconds or longer to complete the OUT1 setting. [P\_2] or [n\_2] is displayed on the sub screen (left). Continue with setting the OUT2. Press and hold the SET button for 2 seconds or longer to complete the setting. The product will return to measurement mode.

\*1: Selected items (1) to (4) become valid after pressing the SET button.

\*2: After enabling the setting by pressing the SET button, it is possible to return to measurement mode by pressing the SET button for 2 seconds or longer.

\*3: When the output mode (refer to page 39) is set to error output or switch output OFF, the simple setting mode cannot be used.

In the window comparator mode, set P1L/P2L, the lower limit of the switch operation, and P1H/P2H, the upper limit of the switch operation, WH1/WH2 (hysteresis) and dt1/dt2 (delay time) following the instructions given on page 29.

(When reversed output is selected, the sub display (left) shows [n1L]/[n2L] and [n1H]/[n2H].)

Please refer to the "List of output modes" on page 41 for the relationship between the set values and operation.

## Function Selection Mode

### ■ Function selection mode

After selecting the channel, in measurement mode, press the S button for 3 seconds or longer (but less than 5 seconds), to display [F 0].

Select to display the function to be changed [F□□]. Press and hold the SET button for 2 seconds or longer in function selection mode to return to measurement mode.

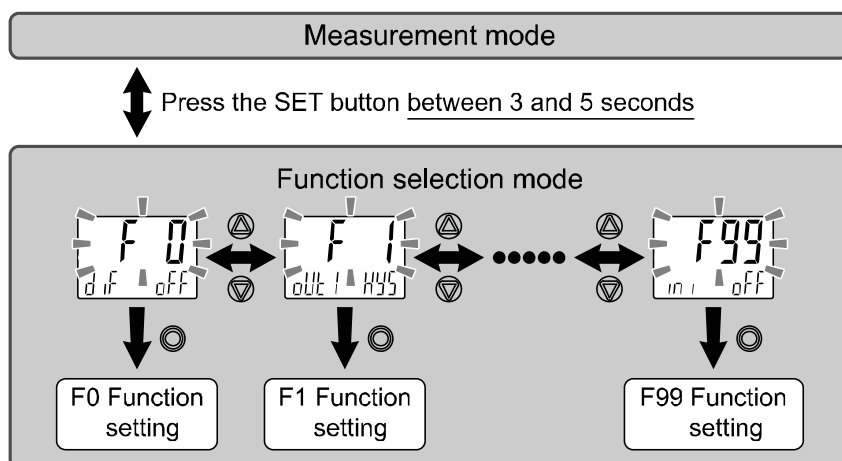

\*: Some products do not have all the functions. If no function is available or selected due to configuration of other functions, [- - -] is displayed on the sub display (right).

\*: All channel indicators turn on for the setting which is common for all channels.

### ■ Default setting

The default setting is as follows.

If no problem is caused by this setting, keep these settings.

To change a setting, enter function selection mode.

- [F 0] Differential pressure check mode, pressure range and display unit ➡ Page 33

Item	Default setting
Differential pressure check mode	OFF
Connected sensor range	Vacuum pressure
Display units	Units specification ["Nil" or M]: [kPa]

- [F 1] Setting of OUT1 ➡ Page 39

Item	Explanation	Default setting
Output mode	Either hysteresis mode, window comparator mode, error output or switch output OFF can be selected.	Hysteresis mode
Reversed output	Selects which type of switch output is used, normal or reversed.	Normal output
Pressure setting	Sets the ON and OFF point of the switch output.	-50.5 kPa
Hysteresis	Appropriate setting of the hysteresis will prevent the switch output from chattering.	5.1 kPa
Delay time	Delay time of the switch output can be selected.	0.00 sec.
Display colour	Select the display colour.	Output ON : Green Output OFF: Red (Linked to OUT1)



●[F 2] Setting of OUT2 ➡ Page 42

Item	Explanation	Default setting
Output mode	Either hysteresis mode, window comparator mode, error output or switch output OFF can be selected.	Hysteresis mode
Reversed output	Selects which type of switch output is used, normal or reversed.	Normal output
Pressure setting	Sets the ON and OFF point of the switch output.	-50.5 kPa
Hysteresis	Appropriate setting of the hysteresis will prevent the switch output from chattering.	5.1 kPa
Delay time	Delay time of the switch output can be selected.	0.00 sec.
Display colour	Select the display colour.	Output ON : Green Output OFF: Red (Linked to OUT1)

●Other parameter settings

Item	Page	Default setting
[F 3] Digital filter setting	Page 44	0.00 sec.
[F 4] Auto-preset function	Page 45	Not used
[F 6] Fine adjustment of display value	Page 47	0.0%
[F10] Sub display setting	Page 48	std (Standard)
[F11] Display resolution setting	Page 54	1000-split
[F14] Zero cut-off setting	Page 55	0.0%
[F80] Power saving mode	Page 56	OFF
[F81] Security code	Page 57	OFF
[F90] Setting of all functions	Page 59	OFF
[F95] Channel to channel copy function setting	Page 61	OFF
[F96] Sensor input display	Page 62	No configurable items
[F98] Output check	Page 63	N/A (normal output)
[F99] Reset to default settings	Page 70	OFF

## ■[F 0] Differential pressure check mode, pressure range and display unit

<Differential pressure check mode>

Selected channel is CH1: Differential pressure between CH1-CH2 can be set and displayed.

Selected channel is CH2: Measurement value of CH2 (normal operation) can be set and displayed.

Selected channel is CH3: Differential pressure between CH3-CH4 can be set and displayed.

Selected channel is CH4: Measurement value of CH4 (normal operation) can be set and displayed.

Selected channel	CH1	CH2	CH3	CH4
Normal operation mode	CH1	CH2	CH3	CH4
Differential pressure check mode	CH1-CH2	CH2	CH3-CH4	CH4
Output	CH1_OUT1 CH1_OUT2	CH2_OUT1	CH3_OUT1	CH4_OUT1
Channel display	CH1/CH2 ON	CH2 ON	CH3/CH4 ON	CH4 ON

\*: When differential pressure check mode is selected, the range of the sensor connected to CH1-CH2 and CH3-CH4 should be the same.

\*: Initial range setting [rAnG] and unit setting [Unit] and digital filter [Fil] for CH2 and CH4 are not selectable. The operations are based on the setting for CH1 and CH3.

\*: Set pressure range during differential pressure check mode is the same as the normal operation mode.

\*: During differential pressure check mode, measurement error "[ - - ]" is displayed when the applied pressure error ([HHH], [LLL]) occurs in one or both selected channel(s).

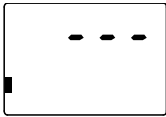

Refer to the connection in the table below for connecting the sensor for differential pressure check mode. Set range can be effectively used by connections below.

Range setting	Selected channel			
	CH1	CH2	CH3	CH4
Compound pressure	Hi/Lo side	Lo/Hi side	Hi/Lo side	Lo/Hi side
Vacuum pressure	Lo side	Hi side	Lo side	Hi side
Low pressure/ Positive pressure/High pressure	Hi side	Lo side	Hi side	Lo side

\*: Hi: High pressure side, Lo: Low pressure side.

### Pressure range setting

Pressure range that matches with the connected sensor can be selected. In addition, the required range can be set and displayed. (Additional range)

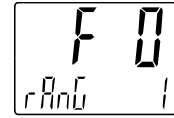

- Relation between the sensor input and pressure display

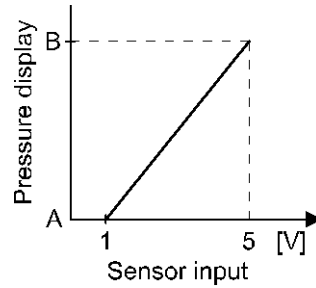

Pressure range	Set value	A	B
Fine differential pressure	0.002	0 kPa	2 kPa
Vacuum pressure	-0.1	0 kPa	-101 kPa
Compound pressure	F0.1	-100 kPa	100 kPa
Low pressure	0.1	0 kPa	100 kPa
Positive pressure	0.5	0 kPa	500 kPa
	1.0	0 MPa	1 MPa
	1.6	0 MPa	1.6 MPa
High pressure	2.0	0 MPa	2 MPa
	5.0	0 MPa	5 MPa
	10.0	0 MPa	10 MPa
	20.0	0 MPa	20 MPa
	25.0	0 MPa	25 MPa
Additional range	USEr	Input value (setting)	Input value (setting)

- Available display unit and minimum set value

Pressure range	Rated pressure	Display	MPa	kPa	Pa	kgf/cm <sup>2</sup>	bar	mbar	psi	inHg	mmHg	mmH <sub>2</sub> O
Fine differential pressure	2 kPa	0.002	-	0.001	1	-	-	0.01	0.001	-	-	0.1
Vacuum pressure	-101 kPa	-0.1	0.001	0.1	-	0.001	0.001	-	0.01	0.1	1	-
Compound pressure	±100 kPa	F0.1	0.001	0.1	-	0.001	0.001	-	0.02	0.1	1	-
Low pressure	100 kPa	0.1	0.001	0.1	-	0.001	0.001	-	0.01	-	-	-
Positive pressure	500 kPa	0.5	0.001	1	-	0.01	0.01	-	0.1	-	-	-
	1 MPa	1.0	0.001	1	-	0.01	0.01	-	0.1	-	-	-
	1.6 MPa											
High pressure	2 MPa	2.0	0.001	1	-	0.01	0.01	-	0.2	-	-	-
	5 MPa	5.0	0.01	-	-	0.1	0.1	-	1	-	-	-
	10 MPa	10.0	0.01	-	-	0.1	0.1	-	1	-	-	-
	20 MPa	20.0	0.01	-	-	0.1	0.1	-	2	-	-	-
	25 MPa	25.0	0.02	-	-	0.2	0.2	-	2	-	-	-
Additional range x 1	USEr	It varies depending on the minimum unit setting of the additional range. (All pressure units are selectable)										

### <Operation>

Press the UP or DOWN button in function selection mode to display [F 0].

Press the SET button.



Move on to the setting of differential pressure check mode.

#### Differential pressure check mode setting (Setting common for all channels)

Set and display the differential pressure between CH1 - CH2, and CH3 - CH4.

Press the UP button to select the differential pressure check mode.

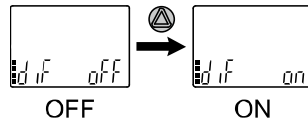

Press the SET button.



Move on to pressure range setting.

\*: When differential pressure check mode is switched, peak/ bottom value, zero clear value and auto-shift corrected value are cleared.



### Pressure range setting

Press the UP or DOWN button to select pressure range.

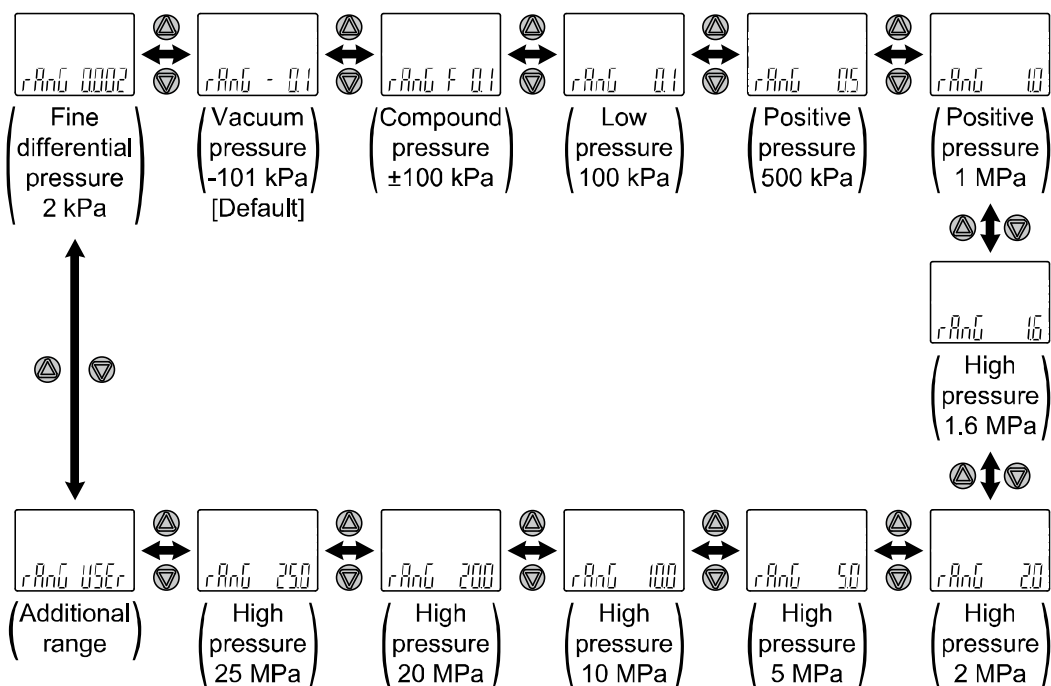

**[USER] is selected.**  
 Press the SET button to move on to the setting of the minimum unit of the additional range.

### Additional range minimum unit setting

Press the UP or DOWN button to select the minimum unit.

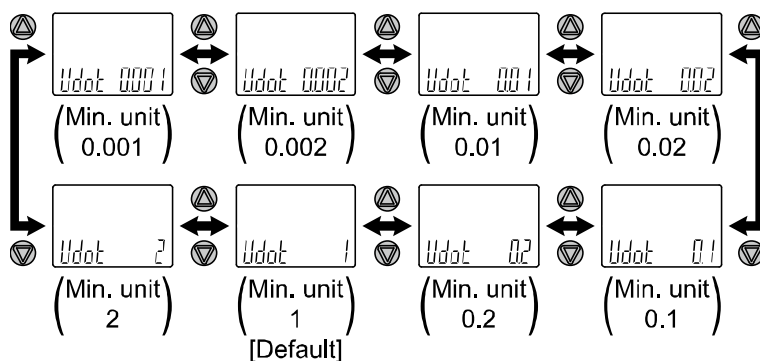

Press the SET button to set.

Move on to the setting of the lower limit of the additional rated range.  
 The lower limit of the rated range is the displayed value when the sensor input signal is 0%.

Other than [USER] is selected.  
 Press the SET button to move on to display unit setting.

**Setting of the lower limit of the additional rated range**

Press the UP or DOWN button to change the value.  
 Press the button continuously to keep changing the value.  
 Set the value that is required to be displayed when the sensor input signal is 0%.  
 The setting range is -1500 to 1500 digit.



\*: There is unsetting range. (Refer to page 38)

Press the SET button to set.

Move on to the setting of the upper limit of the additional rated range.  
 The upper limit of the rated range is the displayed value when the sensor input signal is 100%.

**Setting of the upper limit of the additional rated range**

Press the UP or DOWN button to change the value.  
 Press the button continuously to keep changing the value.  
 Set the value that is required to be displayed when the sensor input signal is 100%.  
 The setting range is -1500 to 1500 digit.

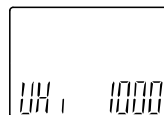

\*: There is unsetting range. (Refer to page 38)

Press the SET button to set. Move on to display unit setting.

**Display unit setting**

Press the UP or DOWN button to select the display unit.

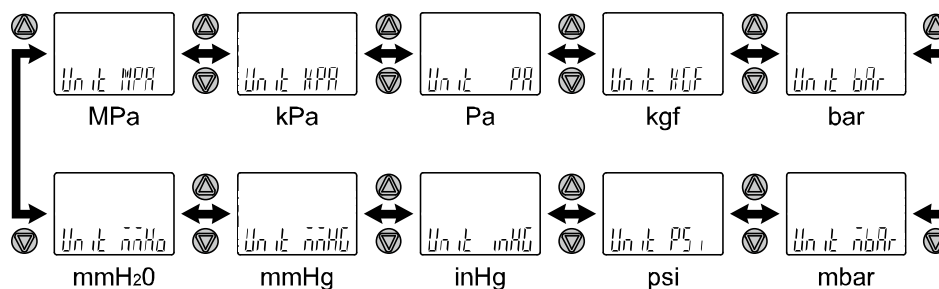
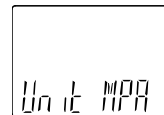

\*: The unit that can be displayed is different depending on the pressure range. (Refer to page 34)  
 (kPa/MPa/Pa can still be selected if the product does not have the units selection function.)  
 \*: Refer to page 9 for LCD of corresponding unit.

Press the SET button to set. Return to function selection mode.

[F0] Setting of differential pressure check mode, pressure range and display unit is completed

- Settable range of the additional range  
 <Minimum settable unit [Udot]: "0.001", "0.01", "0.1", "1">

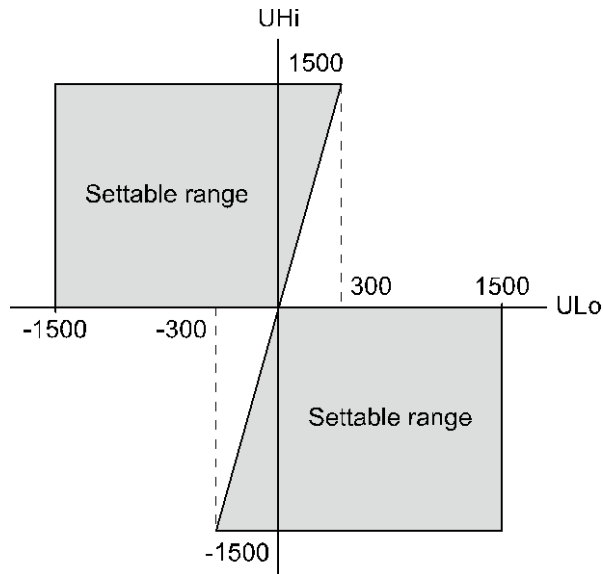

- <Minimum settable unit [Udot]: "0.002", "0.02", "0.2", "2">

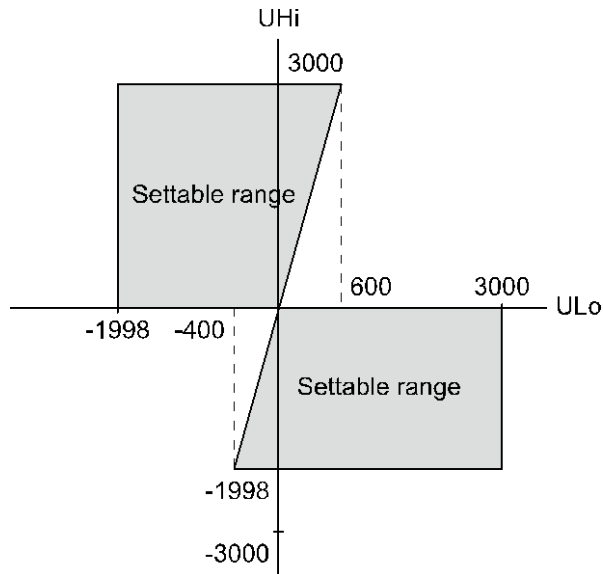

\*: When pressure range, minimum unit/lower limit/upper limit of additional range is changed, setting below will be initialized and cleared. These items must be set again.

- Display unit settings
- Pressure Setting
- Hysteresis setting
- Peak/Bottom value
- Zero-clear value
- Auto-shift correction value

## ■[F 1] Setting of OUT1

Set the output mode of OUT1.

Output turns on when the pressure is greater than the set value. The default setting is to turn on the product when the pressure reaches the center of the atmospheric pressure and upper limit of the rated pressure range.

Output ON lights in green and output OFF lights in red as default setting.

Please refer to the "List of output modes" on page 41 for the relationship between the set items and operation.

### <Operation>

Press the UP or DOWN button in function selection mode to display [F 1].

Press the SET button. ↓ Move on to output mode setting.

**Output mode setting**

Press the UP or DOWN button to select the required output mode.



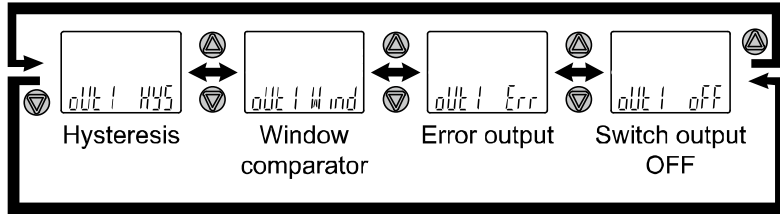

Press the SET button to set. ↓ Move on to reversed output setting.

**Reversed output setting**

Press the UP or DOWN button to select the reversed output.

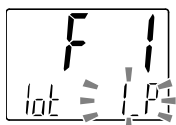

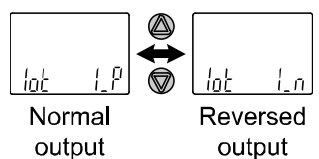

Press the SET button to set. ↓ Move on to pressure setting.

**Pressure setting**

Set the pressure based on the setting method on page 27.

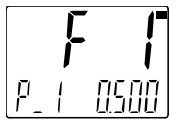

Hysteresis mode: [P\_1]  
 Window comparator mode: [P1L] [P1H]  
 "P" is changed to "n" as [P\_1] → [n\_1] when reversed output is selected.  
 The snap shot function can be used.  
 (Refer to page 71)

[Err] Error output is selected.

Press the SET button to move on to display colour setting.

Press the SET button to set. ↓ Move on to hysteresis setting.

[OFF] Switch output OFF is selected.  
 Press the SET button to move on to display colour setting.



### Hysteresis setting

Set the pressure referring to the setting method on page 27.

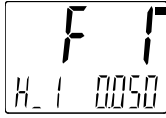

Hysteresis mode: [H\_1]  
Window comparator mode: [WH1]  
The snap shot function can be used.  
(Refer to page 71)

Press the SET button to set. Move on to delay time setting.

### Delay time setting

Set the delay time referring to the setting method on page 29.



Delay time setting at ON

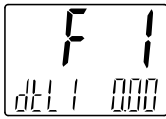

Delay time setting at OFF

Press the SET button to set. Move on to display colour setting.

### Display colour setting

Press the UP or DOWN button to select the display colour.

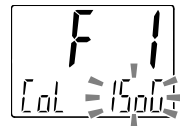

ON: Green OFF: Red (Linked to OUT1) [Default]	ON: Red OFF: Green (Linked to OUT1)	ON: Green OFF: Red (Linked to OUT2)	ON: Red OFF: Green (Linked to OUT2)	Normally: Red	Normally: Green

Press the SET button to set. Return to function selection mode.

[F 1] Setting of OUT1 completed

\*1: Selected item becomes valid after pressing the SET button.

\*2: After enabling the setting by pressing the SET button, it is possible to return to the measurement mode by keeping pressing the SET button for 2 seconds or longer.

•List of output modes

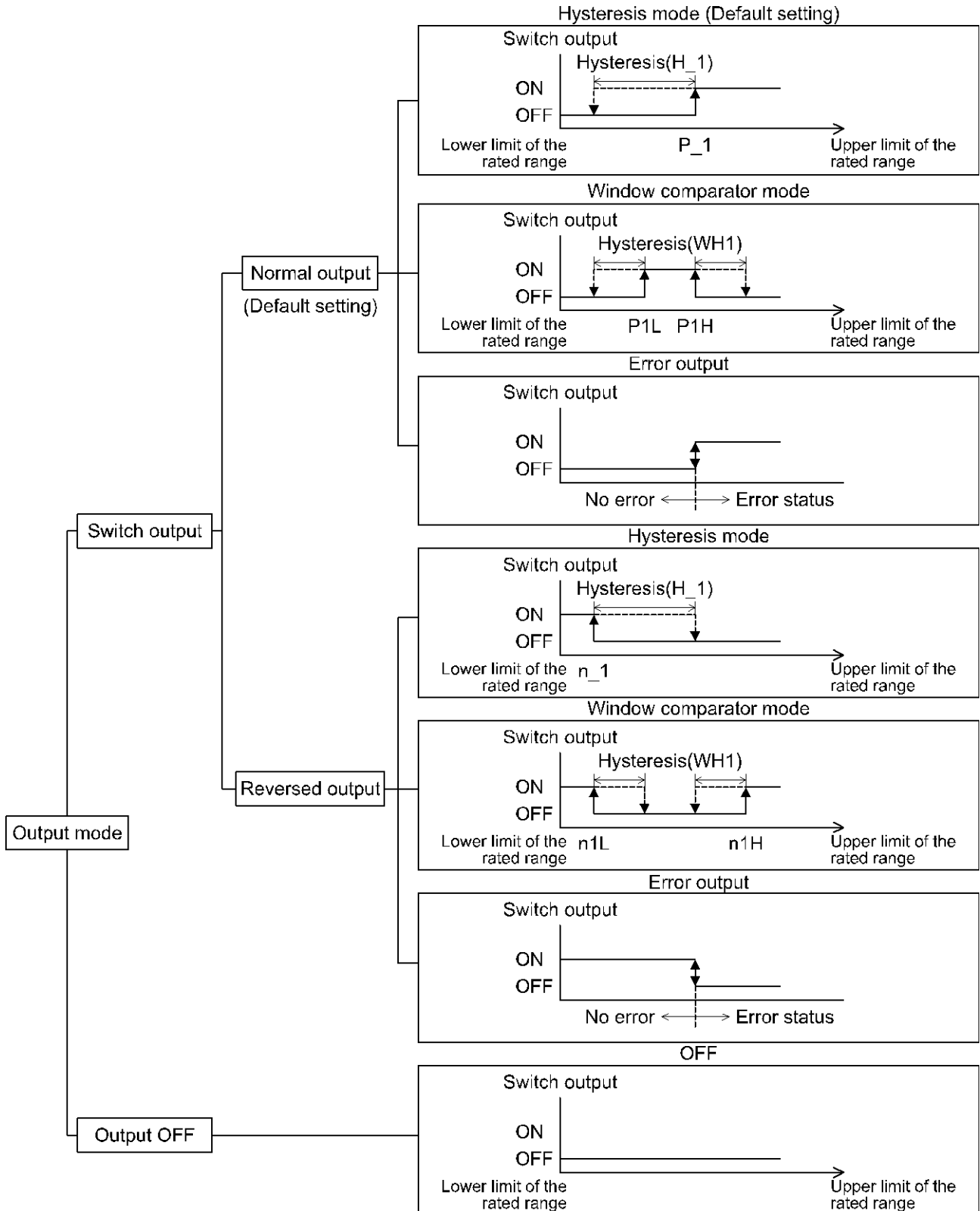

If the point at which the switch output changes is outside of the set pressure range due to the selection of normal or reversed output, the hysteresis value is automatically adjusted.

\*: The figure above shows an operation at OUT 1. For OUT2, all "1" in the figure will be changed to "2". (e.g)  $P_1 \rightarrow P_2$

## ■[F 2] Setting of OUT2

Set the output mode of OUT2.

Output turns on when the pressure is greater than the set value. The default setting is to turn on the product when the pressure reaches the center of the atmospheric pressure and upper limit of the rated pressure range.

Please refer to the "List of output modes" on page 41 for the relationship between the set items and operation. CH2 to CH4 OUT2 setting is output to process data.

### <Operation>

Press the UP or DOWN button in function selection mode to display [F 2].

Press the SET button. ↓ Move on to output mode setting.

**Output mode setting**

Press the UP or DOWN button to select the required output mode.



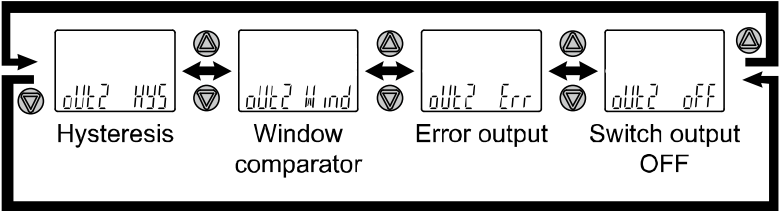

Press the SET button to set. ↓ Move on to reversed output setting.

**Reversed output setting**

Press the UP or DOWN button to select the reversed output.



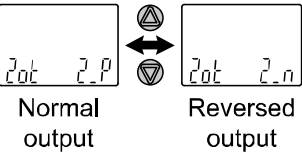

Press the SET button to set. ↓ Move on to pressure setting.

**Pressure setting**

Set the pressure based on the setting method on page 27.



Hysteresis mode: [P\_1]  
 Window comparator mode: [P1L] [P1H]  
 "P" is changed to "n" as [P\_1] → [n\_1] when reversed output is selected.  
 The snap shot function can be used.  
 (Refer to page 71)

[Err] Error output is selected.

Press the SET button to move on to display colour setting.

[OFF] Switch output OFF is selected.

Press the SET button to move on to display colour setting.

Press the SET button to set. ↓ Move on to hysteresis setting.

### Hysteresis setting

Set the pressure referring to the setting method on page 27.



Hysteresis mode: [H\_1]  
Window comparator mode: [WH1]  
The snap shot function can be used.  
(Refer to page 71)

Press the SET button to set. Move on to delay time setting.

### Delay time setting

Set the delay time referring to the setting method on page 29.



Delay time setting at ON



Delay time setting at OFF

Press the SET button to set. Move on to display colour setting.

### Display colour setting (common setting for [F 1])

Press the UP or DOWN button to select the display colour.

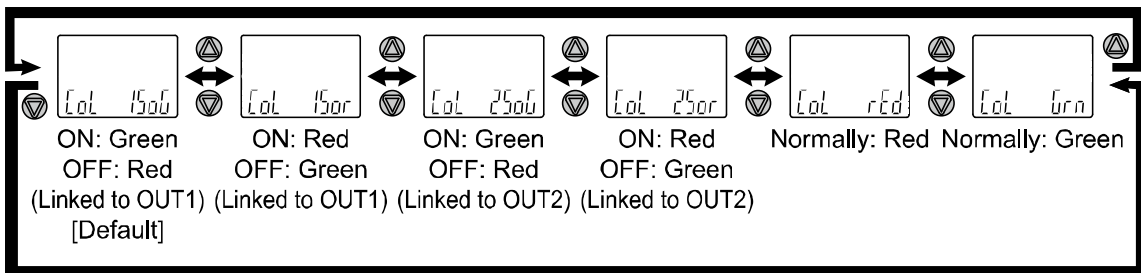

Press the SET button to set. Return to function selection mode.

[F 2] Setting of OUT2 completed

\*1: Selected item becomes valid after pressing the SET button.

\*2: After enabling the setting by pressing the SET button, it is possible to return to the measurement mode by keeping pressing the SET button for 2 seconds or longer.

## ■[F 3] Digital filter setting

The Digital filter can be selected to filter the pressure measurement.  
Output chattering or flicker in the measurement mode display can be reduced by setting the digital filter.

### <Operation>

Press the UP or DOWN button in function selection mode to display [F 3].

Press the SET button. ↓ Move on to digital filter setting.

#### Digital filter setting

Press the UP or DOWN button to select the digital filter.  
The digital filter can be set in the range 0.00 to 30.0 [sec.] in increments of 0.01 [sec.].

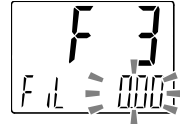

Press the SET button to set. ↓ Return to function selection mode.

[F 3] Digital filter setting completed

\*1: Each set value is a guideline for 90% response time.

\*2: Both the switch output and pressure display are affected. When only switch output needs to be affected, select the delay time setting. (page 29, 40 and 43)

## ■[F 4] Auto-preset function

This function will automatically calculate and set the optimum pressure based on the actual operating condition, when hysteresis mode has been selected.

### <Operation>

Press the UP or DOWN button in function selection mode to display [F 4].

Press the SET button. ↓ Move on to Auto-preset function.

#### Auto-preset function

Press the UP or DOWN button to select the auto-preset function.

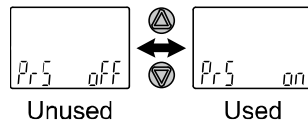

Press the SET button to set. ↓ Return to function selection mode.

[F 4] Auto-preset function completed

Press the SET button in measurement mode to perform the pressure setting.  
Then, press the SET button again to change the pressure while the display is flashing.  
(Refer to page 46 for details.)

●Auto-preset

When auto-preset is selected in function selection mode, the set value can be calculated and memorized from the measured pressure. Repeating the suction and release of the workpiece to be set for several times will automatically optimize the set value.

(1) Selection of auto-preset OUT1 mode

Press the SET button in measurement mode to display [AP1 rEdY].  
 (If setting of OUT1 is not necessary, select [AP1 rEdY], and then press the UP and DOWN buttons simultaneously for 1 second or longer.  
 The display will move to (4) Selection of auto-preset OUT2 mode.)



Auto-preset is ready

(2) Preparation of equipment for OUT1

Prepare the equipment for which the pressure of OUT1 is to be set.

(3) Setting of auto-preset for OUT1

Press the SET button, [AP1 rUn] will be displayed.  
 Measurement starts. Operate the device to change the pressure.  
 (If the UP and DOWN buttons are pressed simultaneously for 1 second or longer while [AP1 rUn] is displayed, measurement will be stopped and (4) Selection of auto-preset OUT2 mode will return.)



Auto-preset is being set

(4) Selection of auto-preset OUT2 mode

Press the SET button in measurement mode to display [AP2 rEdY].  
 (If setting of OUT2 is not necessary, select [AP2 rEdY], and then press the UP and DOWN buttons simultaneously for 1 second or longer.  
 The display will move to measurement mode.)



Auto-preset is ready

(5) Preparation of equipment for OUT2

Prepare the equipment for which the pressure of OUT2 is to be set.

(6) Setting of auto-preset for OUT2

Press the SET button, [AP2 rUn] will be displayed.  
 Measurement starts. Operate the device to change the pressure.  
 (If the UP and DOWN buttons are pressed simultaneously for 1 second or longer while [AP2 rUn] is displayed, measurement will be stopped and measurement mode will return.)



Auto-preset is being set

(7) Complete setup.

Press the SET button to complete auto-preset mode. Then, measurement mode returns.

The settings in auto-preset will be as follows.

•Normal output

$$P_1(P_2)=A-(A-B)/4$$

$$H_1(H_2)=|(A-B)/2|$$

•Reversed output

$$n_1(n_2)=B+(A-B)/4$$

$$H_1(H_2)=|(A-B)/2|$$

A = Maximum pressure

B = Minimum pressure

If setting is not necessary press the UP and DOWN buttons simultaneously for 1 second or longer.

## ■[F 6] Fine adjustment of display value

This function is to manually perform a fine adjustment of the displayed pressure value.  
Pressure can be adjusted in the following range of  $\pm 5\%$ R.D.

### <Operation>

Press the UP or DOWN button in function selection mode to display [F 6].

Press the SET button. ↓ Move on to fine adjustment of display value.

#### Fine adjustment of display value

Press the UP or DOWN button to change adjustment rate.

When adjustment rate is changed, the pressure value after the adjustment will be displayed on the main screen.

Pressure after adjustment



Adjustment rate

Press the SET button to set. ↓ Return to function selection mode.

[F 6] Fine adjustment of display value completed



## ■[F10] Sub display setting

Change the display style of the sub display.  
Detailed contents are shown in the pages from 49.

### <Operation>

Press the UP or DOWN button in function selection mode to display [F10].

Press the SET button. ↓ Move on to sub display setting.

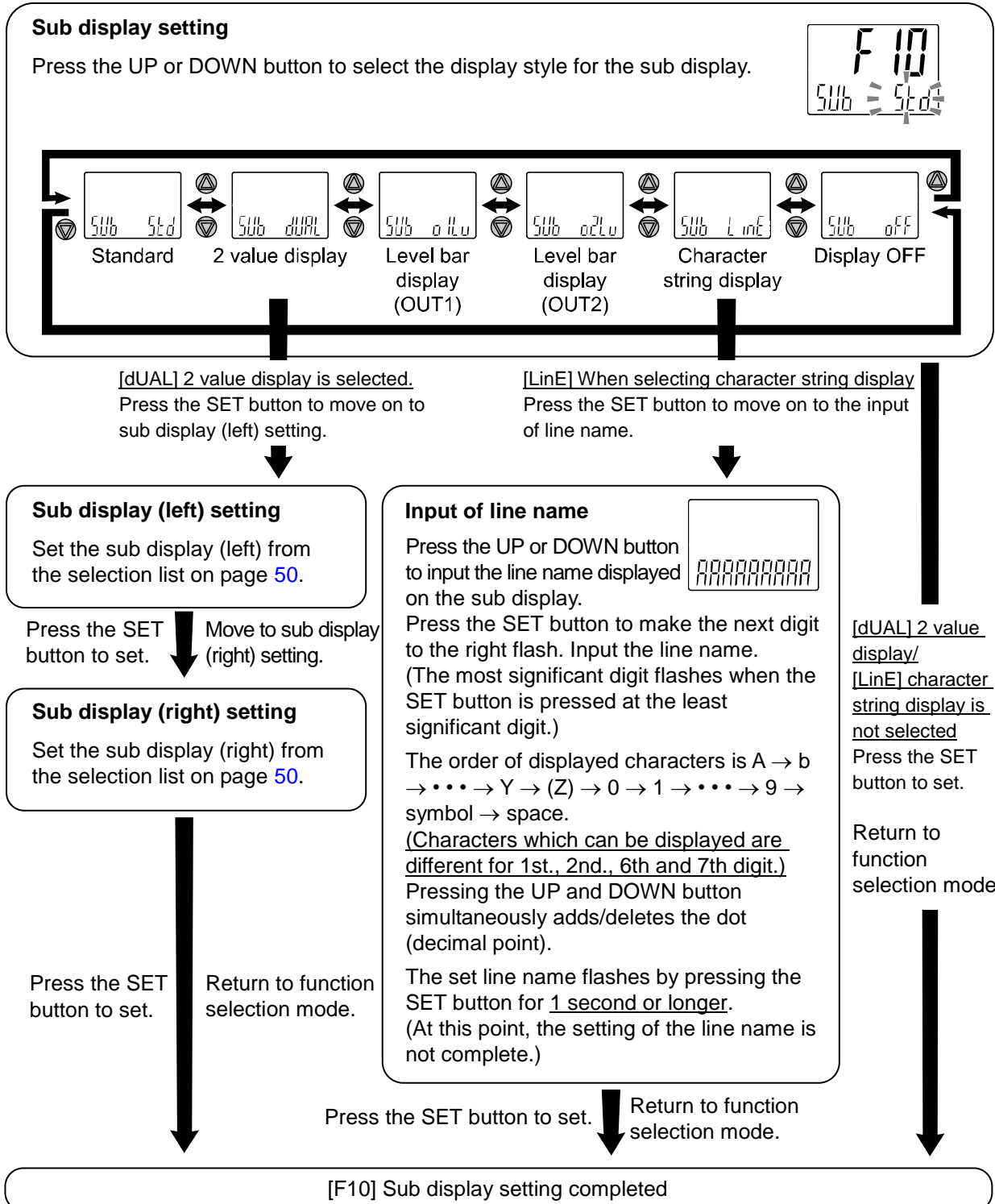

## <Sub display>

### •Standard

The Standard display function displays the items and values on the sub display.

The displayed item varies depending on the setting of the output mode. Select the displayed items by pressing the DOWN button in measurement mode.

(Hysteresis mode, error output, switch output off)

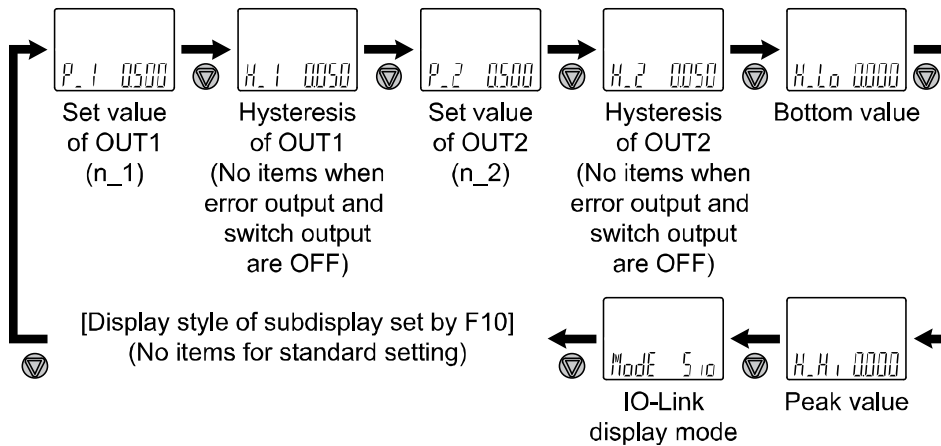

(Window comparator mode)

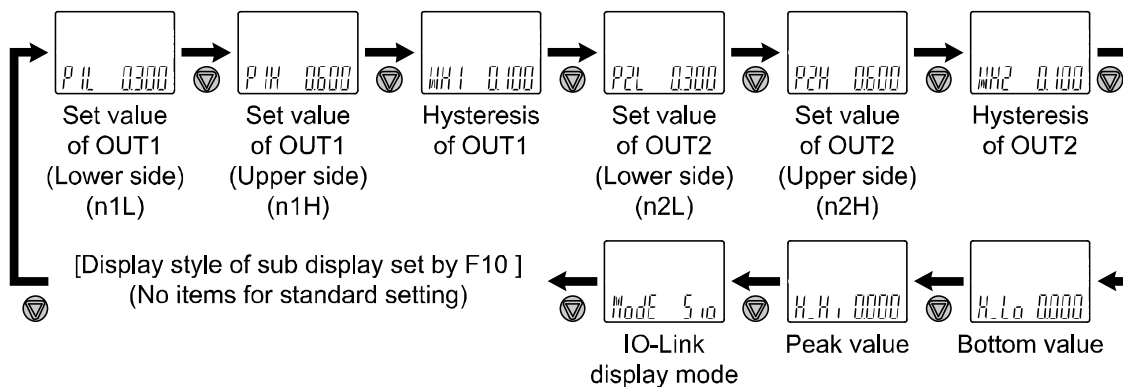







•2 value display

The 2 value display function displays the items listed below on the right and left side of the sub display.

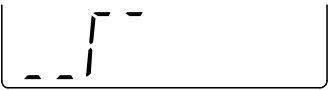
List of items for selection

Item	Details	Sub display		Remarks
		Left side	Right side	
P_1 (n_1)	Set value for OUT1 hysteresis mode	○	○	When hysteresis mode is selected
H_1	OUT1 hysteresis mode	○	○	When hysteresis mode is selected
P_HL (n_HL)	OUT1 Window comparator mode set value (Lower side)	○	○	When window comparator mode is selected
P_HH (n_HH)	OUT1 Window comparator mode set value (Upper side)	○	○	When window comparator mode is selected
WH1	OUT1 window comparator mode	○	○	When window comparator mode is selected
P_2 (n_2)	Set value for OUT2 hysteresis mode	○	○	When hysteresis mode is selected
H_2	OUT2 hysteresis mode	○	○	When hysteresis mode is selected
P_2L (n_2L)	OUT2 Window comparator mode set value (Lower side)	○	○	When window comparator mode is selected
P_2H (n_2H)	OUT2 Window comparator mode set value (Upper side)	○	○	When window comparator mode is selected
WH2	OUT2 window comparator mode	○	○	When window comparator mode is selected
H_H1	Pressure peak value	○	×	
H_L0	Pressure bottom value	×	○	
Unit	Pressure display unit	○	○	
rPRG	Rated pressure range	○	○	
Md1	OUT1 output mode/output style	○	×	
Md2	OUT2 output mode/output style	×	○	
L_inE	String of random characters	○	×	Line name 4 left digits
L_inE	String of random characters	×	○	Line name 5 right digits
CH	Channel display	○	○	
Mu1	Measured value of CH1	○	○	
Mu2	Measured value of CH2	○	○	
Mu3	Measured value of CH3	○	○	
Mu4	Measured value of CH4	○	○	
OFF	Display OFF	○	○	

Table showing the output mode and output form when Md1 and Md2 are selected.

Output mode	Output style	Display style
Hysteresis mode	Normal output	
	Reversed output	
Window comparator mode	Normal output	
	Reversed output	
Error output	Normal/Reversed output	
Switch output off	-	

When using the 2 value display function, 3 step setting is not available for the display.  
 (When setting 3 step, select each set value to be displayed by pressing the DOWN button.)

When output operation mode is changed after selecting the 2 value display, the selected display items will not be applicable and [- -] will be displayed. In this case, select items for the 2 value display setting again.

•Level bar display

The Level bar display is a function used to visualize the pressure and the ON area for the switch output on the sub display.

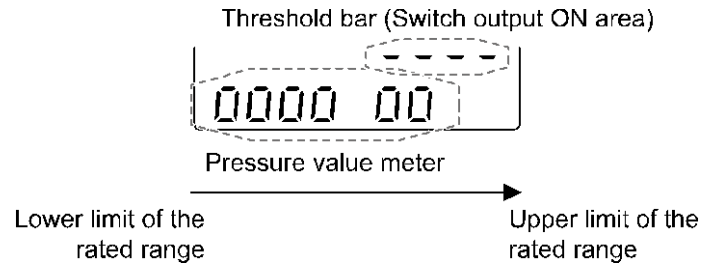

The display style varies depending on the setting of the output mode.

(In hysteresis mode or window comparator mode)

The threshold bar displaying the switch output ON area is displayed according to the table below, using the output mode.

(During error output or when the switch output is OFF)

The threshold bar will not be displayed. Only the pressure value meter is displayed.

Output mode	Output style	Threshold bar display style
Hysteresis mode	Normal output	P <sub>1</sub>
	Reversed output	n <sub>1</sub>
Window comparator mode	Normal output	P1L P1H
	Reversed output	n1L n1H
Error output	Normal/Reversed output	No indication
Switch output off	-	No indication

The Level bar display resolution (pressure for one "O") varies depending on the output mode.

Output mode	Display resolution	
	OUT1	OUT2
Hysteresis mode	1/10 of P <sub>1</sub> (n <sub>1</sub> )	1/10 of P <sub>2</sub> (n <sub>2</sub> )
Window comparator mode	1/4 of P1H – P1L (n1H – n1L)	1/4 of P2H – P2L (n2H – n2L)
Error output	1/7 of rated maximum pressure - rated minimum pressure	
Switch output off		

During an error output or when the switch output setting is OFF, the pressure value meter at the atmospheric pressure is displayed according to the table below.

Rated range	Display at atmospheric pressure	
Other than compound pressure		or
Compound pressure		or

**•Character string display**

•Function to display the specified character string on the sub-screen.

When line name is input, characters which can be displayed for each digit are as follows.

(Display pattern for 3rd, 4th, 5th, 8th and 9th digit from the left)

Characters Q, X, Z, /, or \* cannot be displayed.

A B C D E F G H I J K L M N O P R S T U V W Y

0 1 2 3 4 5 6 7 8 9 Symbol Speace

(Display patter for 1st., 2nd., 6th., and 7th digit)

Characters A to Z can be displayed (the same as the 3 digits on the right).

A B C D E F G H I J K L M N O P Q R S T U V W X Y Z

<Pattern for 3 digits on the right>

0 1 2 3 4 5 6 7 8 9 Symbol K M N R V W Speace

**•Display OFF**

The Sub display is not displayed.

## ■[F11] Display resolution setting

This function is to change the pressure display resolution.  
The flicker of the display can be reduced.

### <Operation>

Press the UP or DOWN button in function selection mode to display [F11].

Press the SET button. ↓ Move on to display resolution setting.

#### Display resolution setting

Press the UP or DOWN button to select the display resolution.

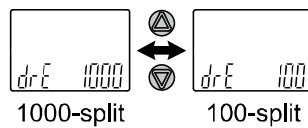

Press the SET button to set. ↓ Return to function selection mode.

[F11] Display resolution setting completed

\*: The display resolution is not possible to be selected while setting the additional range.

\*: It may not be possible to change the resolution depending on the unit of pressure selected.

The units that allow display resolution to be selected are [MPa], [kPa], [kgf/cm<sup>2</sup>], [bar], [mbar], [psi], [inHg] and [mmH<sub>2</sub>O].

(The units [kgf/cm<sup>2</sup>], [bar], [mbar], [psi], [inHg] and [mmH<sub>2</sub>O] can only be set when using a product with units selection function.)

➡ Page 33 [F 0] Differential pressure check mode, pressure range and display unit

## ■[F14] Zero cut-off setting

When the pressure display value is close to zero, the product rounds the value and zero will be displayed. The zero cut-off range is 0.0 to 10.0% F.S., and can be set in 1.0% F.S. increments.

### <Operation>

Press the UP or DOWN button in function selection mode to display [F14].

Press the SET button. ↓ Move on to select zero cut-off setting.

#### Select zero cut-off setting

Press the UP or DOWN button to select the value of zero cut-off.

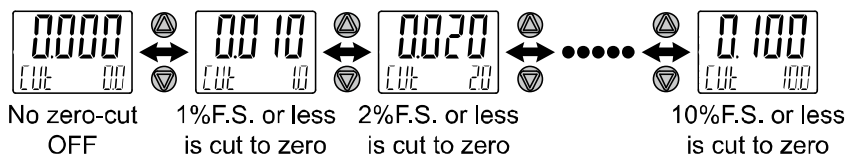
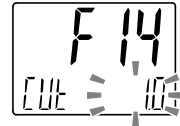

\*: The display above is an example when 1 MPa range and unit selection function are [MPa] selected.

\*: When the actual pressure is smaller than the displayed value in the upper line, zero will be displayed.

Example: 1 MPa range  $P_1 = 0.015$  [MPa],  $H_1 = 0.01$  [MPa], zero cut-off 1.0%

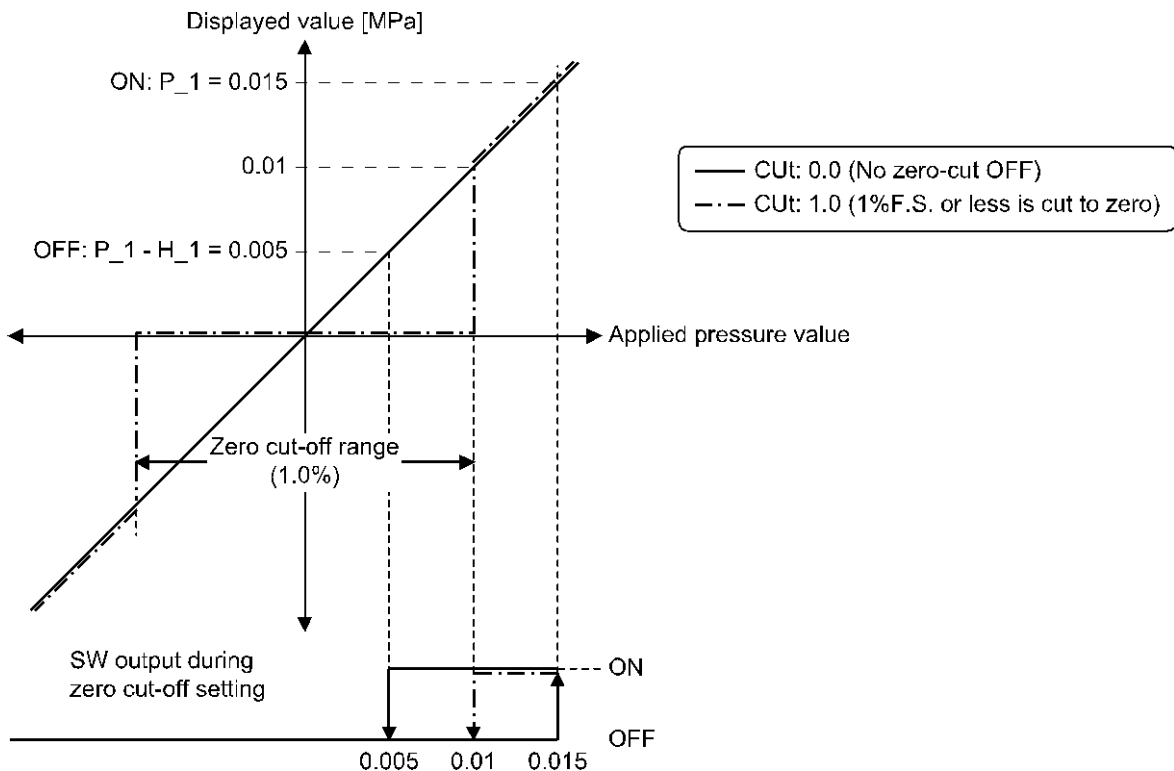

Press the SET button to set. ↓ Return to function selection mode.

[F14] Zero cut-off setting completed



## ■[F80] Power saving mode

Power saving mode can be selected.

When selected and no buttons are pressed for 30 seconds, the product will shift to power saving mode.

### <Operation>

Press the UP or DOWN button in function selection mode to display [F80].

Press the SET button. ↓ Move on to power saving mode.

#### Power saving mode (Setting common for all channels)

Press the UP or DOWN button to select the power saving mode.

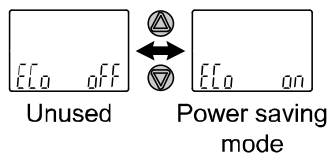

Press the SET button to set. ↓ Return to function selection mode.

[F80] Power saving mode completed

In power saving mode, when buttons are pressed the display is normal, but if no buttons are pressed for 30 seconds, it will revert to power saving mode. (Power saving is only enabled in measurement mode)

During power saving mode, [ECo] will flash in the sub display and the operation light is ON (only when the switch is ON).

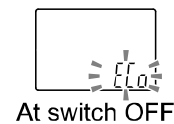
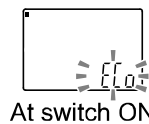

## ■[F81] Security code

The security code can be turned on or off and the security code can be changed when unlocked.

### <Operation>

Press the UP or DOWN button in function selection mode to display [F81].

Press the SET button. ↓ Move on to security code.

#### Security code (Setting common for all channels)

Press the UP or DOWN button to select the setting of security code.

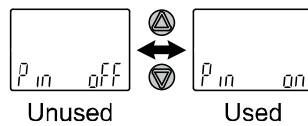

Press the SET button to set. ↓ Move on to security code checking.

#### Security code checking

Press the UP or DOWN button to input the security code on the sub display (right).  
(The default setting is [000].) \*

For instructions on how to enter the security code, refer to "How to input and change the security code" on page 74.

If the security code entered is incorrect, [FAL] will be displayed, and the security code must be entered again.

If the wrong security code is entered 3 times, [nG] is displayed and the device returns to function selection mode.

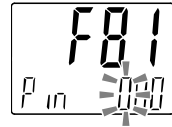

[oFF] (not use) is selected.

Press the SET button to return to function selection mode.

Press the SET button for 1 second to set. ↓ Move on to security code changing.

### Security code changing

Press the UP or DOWN button to input the changed security code on the main display. \*  
For instructions on how to enter the security code, refer to "How to input and change the security code" on page 74.



After entry, the changed security code will flash by pressing the SET button for 1 second.  
(At this point, the changing of the security code is not completed)  
Return to the change of setting again by pressing the UP or DOWN button.



Press the SET button for 1 second to set. ↓ Return to function selection mode.

[F81] Security code completed

If the security code function is enabled, it is will be necessary to input a security code to release the key-lock.

\*: If a key is not pressed for 30 seconds while entering the security code, function selection mode will return.

● **Special function setting**

■ **[F90] Setting of all functions**

All functions can be set in turn.

<Operation>

Press the UP or DOWN button in function selection mode to display [F90].

Press the SET button. ↓ Move on to setting of all functions.

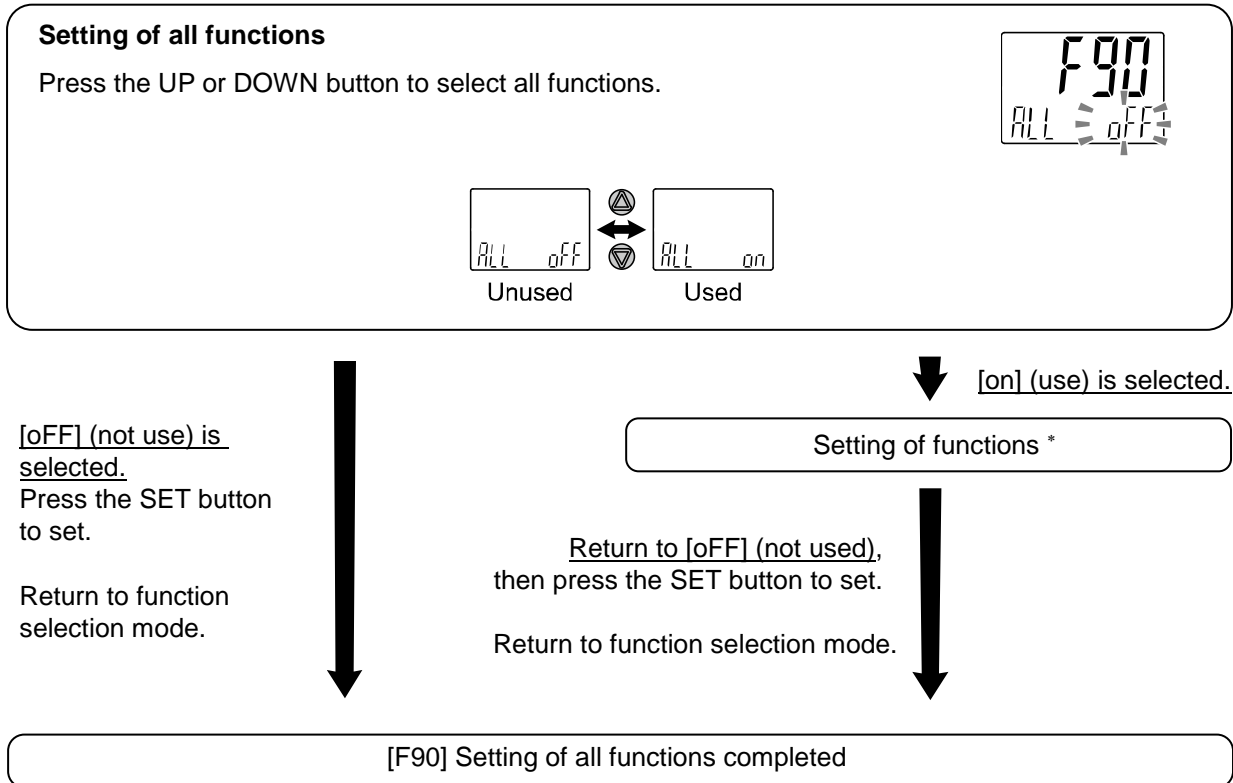

\*: Setting of each function

Every time the SET button is pressed, the display moves to the next function in order of "Setting of each function" on page 60. Set by using the UP and DOWN buttons.

For details of how to set each function, refer to the relevant setting of function section in this manual.

\*: Measurement mode can be returned from any setting items by pressing and holding the SET button for 2 seconds or longer.

\*: The function setting from before returning to the measurement mode is maintained.

● Setting of each function

Order	Function
1	Differential pressure check mode setting
2	Pressure range setting
3	Display unit selection
4	Output mode setting of OUT1
5	Reversed output setting of OUT1
6	Pressure setting of OUT1
7	Hysteresis setting of OUT1
8	Delay time setting of OUT1
9	Display colour setting
10	Output mode setting of OUT2
11	Reversed output setting of OUT2
12	Pressure setting of OUT2
13	Hysteresis setting of OUT2
14	Delay time setting of OUT2
15	Display colour setting
16	Digital filter setting
17	Auto-preset function
18	Fine adjustment of display value
19	Sub display setting
20	Display resolution setting
21	Zero cut-off setting
22	Power saving mode
23	Security code

\*: Measurement mode can return from any setting item by pressing the SET button for 2 seconds or longer.

\*: Function set before returning to the measurement mode is maintained.

## ■[F95] Channel to channel copy function setting

Set channel to channel copy function.

### <Operation>

Press the UP or DOWN button in function selection mode to display [F95].

Press the SET button. ↓ Move on to channel to channel copy function setting.

#### Channel to channel copy function setting

Set values between [F 0] and [F80] are copied to the other channel (except [F 6] Finely adjusted value).

Press the UP or DOWN button to select the channel to channel copy function.

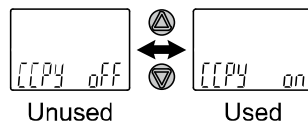

[OFF] (not use) is selected.

Press the SET button to return to function selection mode.

[on] (use) is selected.  
Press the SET button to set.

#### Select the channel to be copied

Press UP or DOWN button to select the channel to be copied in the sub screen (on the right).

\*: Channel from which a copy is made of the currently selected channel.

Displayed in the the sub screen (on the left).

\*: When changing the channel to be copied, change the channel in measurement mode and the select function again.

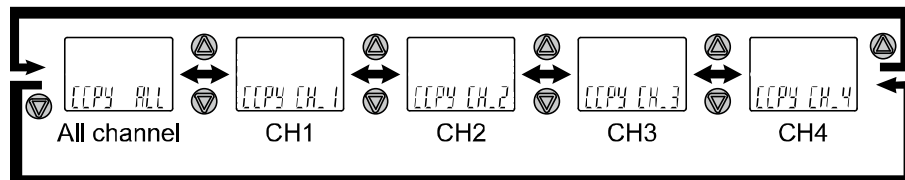

Press the SET button to start copying. When copying is finished, the mode returns to channel to channel copy function setting.

When UP and DOWN buttons are pressed simultaneously, copying is NOT performed, but returns to channel to channel copy function setting.

Channel to channel copy function setting

Press the SET button to set. ↓ Return to function selection mode.

[F95] Channel to channel copy function setting is completed

## ■[F96] Sensor input display

The sensor input signal (1 to 5 V) can be checked.

### <Operation>

Press the UP or DOWN button in function selection mode to display [F96].

Press the SET button. ↓ Move on to sensor input display.

#### Sensor input display

Select to display the sensor input by pressing the SET button.

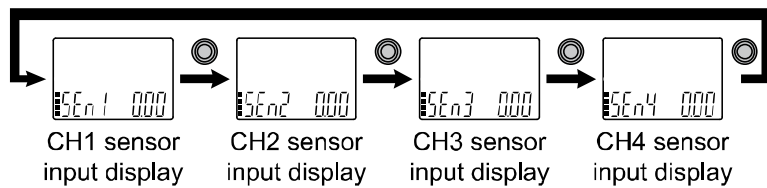

CH1 sensor  
input display

CH2 sensor  
input display

CH3 sensor  
input display

CH4 sensor  
input display

## ■[F98] Output check

It is possible to check the switch output operation and process data value.  
The switch output and process data value can be turned ON/OFF independently.

### <Operation>

Press the UP or DOWN button in function selection mode to display [F98].

Press the SET button. ↓ Move on to output check.

#### Output check

Press the UP or DOWN button to select output check.

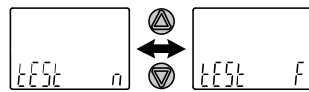

Normal output (Output not checked)      Forcibly output (Output is checked)

[n] (Normal output) is selected.

Press the SET button to set.

Return to function selection mode

[F] (Forced output) is selected.  
Press the SET button to set.

Move on to OUT1 output check (CH1).

#### OUT1 output check (CH1)

Press the UP or DOWN button to select OUT1 output check.

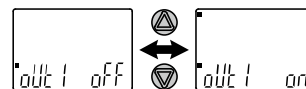
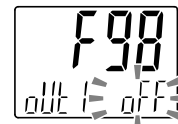

Forcibly output OFF      Forcibly output ON

Press the SET button to set.

Move on to OUT2 output check (CH1).

#### OUT2 output check (CH1)

Press the UP or DOWN button to select OUT2 output check.

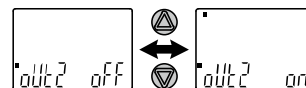

Forcibly output OFF      Forcibly output ON

Press the SET button to set.

Move on to OUT1 output check (CH2).



**OUT1 output check (CH2)**

Press the UP or DOWN button to select OUT1 output check.

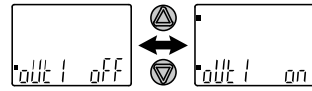

Forcibly output OFF      Forcibly output ON

Press the SET button to set.

Move on to OUT2 output check (CH2).

**OUT2 output check (CH2)**

Press the UP or DOWN button to select OUT2 output check.

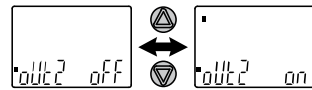

Forcibly output OFF      Forcibly output ON

\*: IO-Link mode can provide the communication function.

Press the SET button to set.

Move on to OUT1 output check (CH3).

**OUT1 output check (CH3)**

Press the UP or DOWN button to select OUT1 output check.

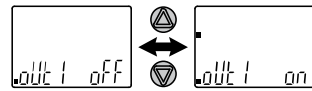

Forcibly output OFF      Forcibly output ON

Press the SET button to set.

Move on to OUT2 output check (CH3).

### OUT2 output check (CH3)

Press the UP or DOWN button to select OUT2 output check.

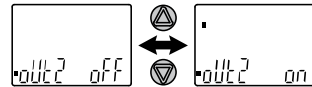

Forcibly output OFF      Forcibly output ON

\*: IO-Link mode can provide the communication function.

Press the SET button to set.

Move on to OUT1 output check (CH4).

### OUT1 output check (CH4)

Press the UP or DOWN button to select OUT1 output check.

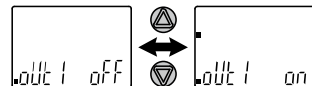

Forcibly output OFF      Forcibly output ON

Press the SET button to set.

Move on to OUT2 output check (CH4).

### OUT2 output check (CH4)

Press the UP or DOWN button to select OUT2 output check.

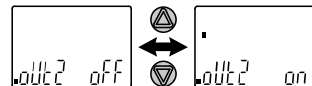

Forcibly output OFF      Forcibly output ON

\*: IO-Link mode can provide the communication function.

Press the SET button to set.

Move on to diagnostic output check (CH1).

### Diagnostic output check (CH1)

Press the UP or DOWN button to select diagnostic output check.

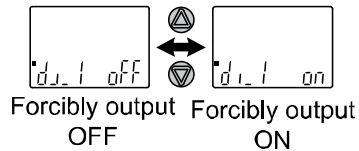

- \*: IO-Link mode can provide the communication function.
- \*: Refer to page 76 for details of the diagnostic information.

Press the SET button to set.

Move on to diagnostic output check (CH2).

### Diagnostic output check (CH2)

Press the UP or DOWN button to select diagnostic output check.

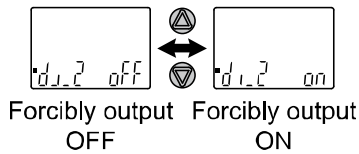

- \*: IO-Link mode can provide the communication function.
- \*: Refer to page 76 for details of the diagnostic information.

Press the SET button to set.

Move on to diagnostic output check (CH3).

### Diagnostic output check (CH3)

Press the UP or DOWN button to select diagnostic output check.

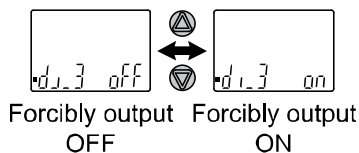
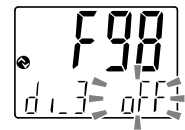

- \*: IO-Link mode can provide the communication function.
- \*: Refer to page 76 for details of the diagnostic information.

Press the SET button to set.

Move on to diagnostic output check (CH4).

### Diagnostic output check (CH4)

Press the UP or DOWN button to select diagnostic output check.

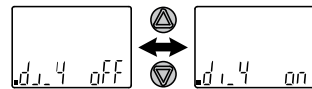

Forcibly output OFF      Forcibly output ON

\*: IO-Link mode can provide the communication function.

\*: Refer to page 76 for details of the diagnostic information.

Press the SET button to set. ↓ Move on to error diagnostic.

### Error diagnostic

Press the UP or DOWN button to select error diagnostic.

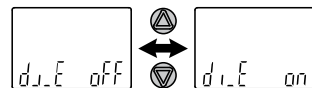

Forcibly output OFF      Forcibly output ON

\*: IO-Link mode can provide the communication function.

\*: Refer to page 76 for details of the error diagnostic.

Press the SET button to set. ↓ Move on to the process data measurement value output check (CH1).

### Process data measurement value output check (CH1)

The upper and lower limit values of the rated pressure value can be output compulsively as PD measurement value (process data). Press the UP or DOWN button to select the lower or upper limit value.

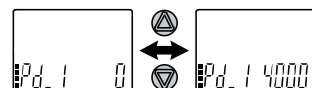
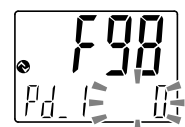

Output of the PD measurement value is ON at the rated lower limit value      Output of the PD measurement value is ON at the rated upper limit value

\*: IO-Link mode can provide the communication function.

\*: Refer to page 76 for details of the PD measurement value.

Press the SET button to set. ↓ Move on to the process data measurement value output check (CH2).

### Process data measurement value output check (CH2)

The upper and lower limit values of the rated pressure value can be output compulsively as PD measurement value (process data). Press the UP or DOWN button to select the lower or upper limit value.

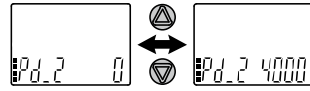

Output of the PD measurement value is ON at the rated lower limit value

Output of the PD measurement value is ON at the rated upper limit value

\*: IO-Link mode can provide the communication function.

\*: Refer to page 76 for details of the PD measurement value.

Press the SET button to set.

Move on to the process data measurement value output check (CH3).

### Process data measurement value output check (CH3)

The upper and lower limit values of the rated pressure value can be output compulsively as PD measurement value (process data). Press the UP or DOWN button to select the lower or upper limit value.

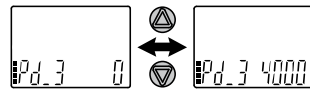

Output of the PD measurement value is ON at the rated lower limit value

Output of the PD measurement value is ON at the rated upper limit value

\*: IO-Link mode can provide the communication function.

\*: Refer to page 76 for details of the PD measurement value.

Press the SET button to set.

Move on to the process data measurement value output check (CH4).

### Process data measurement value output check (CH4)

The upper and lower limit values of the rated pressure value can be output compulsively as PD measurement value (process data). Press the UP or DOWN button to select the lower or upper limit value.

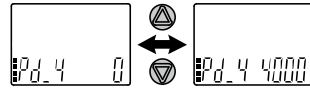

Output of the PD measurement value is ON at the rated lower limit value

Output of the PD measurement value is ON at the rated upper limit value

\*: IO-Link mode can provide the communication function.

\*: Refer to page 76 for details of the PD measurement value.

Press the SET button to return to [n] (normal output), then press the SET button to set.

Return to function selection mode.

Press the SET button for 2 seconds or longer.

[F98] Output check completed

Measurement mode

\*: Measurement mode can return from any setting item by pressing the SET button for 2 seconds or longer.

## ■[F99] Reset to default settings

If the product settings are uncertain, the default values can be restored.

\*: All channels return to default condition.

### <Operation>

Press the UP or DOWN button in function selection mode to display [F99].

Press the SET button. ↓ Move on to reset to default settings.

#### Reset to default settings

Press the UP or DOWN button to display [ON], then press the SET and DOWN buttons simultaneously for 5 second or longer.

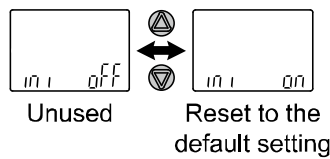

[oFF] (not use) is selected.  
Press the SET button to set.

Return to function selection mode.

All settings are returned to the default values. Return to function selection mode.

[F99] Reset to default settings completed

## Other Settings

### ○Channel scan function

•Press the UP button for 2 seconds or longer. Channels and the measured pressures will be displayed in order approximately every 2 seconds.

•The function can be released by pressing the UP button again for 2 seconds or longer.

\*: Channel scan function will remain even when the power supply is turned off.

\*: During channel scan, setting is disabled other than channel scan mode release and key lock function setting.

Release the channel scan mode when changing settings.

### ○Snap shot function

The current pressure value can be stored to the switch output ON/OFF set point.

When the items of sub display (left) below are selected in 3 step setting mode, simple setting mode or function selection mode ([F 1] Setting of OUT1, [F 2] Setting of OUT2), by pressing the UP and DOWN buttons simultaneously for 1 second or longer, the value of the sub display (right) shows [- - -], and the values corresponding to the current pressure values are automatically displayed.

Output mode	Configurable items	Sub display (left)	Snap shot function
Hysteresis mode	Set value	$P_{-1} (n_{-1}) / P_{-2} (n_{-2})$	○
	Hysteresis	$H_{1} / H_{2}$	○
Window comparator mode	Set value	$P_{1L} (n_{1L}), P_{1H} (n_{1H})$ $P_{2L} (n_{2L}), P_{2H} (n_{2H})$	○
	Hysteresis	$H_{1} / H_{2}$	×

#### •Set value

The value is set to the same value as the display value (current pressure value).

(There is a range which cannot be set to the current pressure depending on the hysteresis. In that case, the value is set to the closest value.)

#### •Hysteresis

The hysteresis is calculated from the equation below and set.

Normal output: (set value) - (current pressure value)

Reverse output: (current pressure value) - (set value)

If the calculation result becomes 0 or less, [Err] is displayed on the sub display (right) and the set value is not changed.

Afterwards, it is possible to adjust the value by pressing the UP or DOWN button.

### ○Peak/bottom value indication

The maximum (minimum) pressure when the power is supplied is detected and updated.

In peak/bottom indication mode, the current pressure is displayed.

Press the DOWN button in measurement mode to switch the sub-display (left) to the display shown below.

Peak/bottom values are displayed on the sub display (right) at the same time as the current pressure value on the main display.

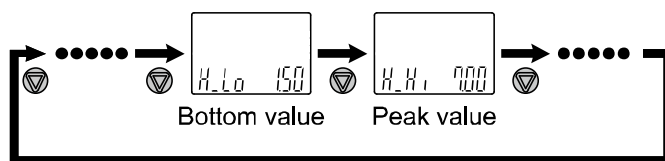

When the SET and DOWN buttons are pressed for 1 second or longer simultaneously while the peak/bottom values are displayed, the sub display (right) displays [- - -] and the maximum (minimum) pressure value are cleared.

\*: Peak/ bottom value are not stored to memory.



○Zero-clear function

The displayed value can be adjusted to zero if the pressure being measured is within  $\pm 7\%$ F.S ( $\pm 3.5\%$ F.S. for compound pressure) of the zero point set at the time of default settings.

(The zero clear range varies by  $\pm 1\%$ F.S. due to variation between individual products.)

In measurement mode, when the UP and DOWN buttons are pressed for 1 second or longer simultaneously, the main display shows [- - -], and the reset to zero. The display returns to measurement mode automatically.

○Key-lock function

The key-lock function is used to prevent errors occurring due to unintentional changes of the set values. If the SET button is pressed while the keys are locked, [LoC] is displayed on the sub display (left) for approximately 1 second.

(Each setting and peak/bottom values are displayed with UP and DOWN buttons.)

**<Operation - Without security code input ->**

(1) Press the SET button for 5 seconds or longer in measurement mode. When [oPE] is displayed on the main display, release the button.

The current setting [LoC] or [UnLoC] will be displayed on the sub display.

(To release key-lock repeat the above operation.)

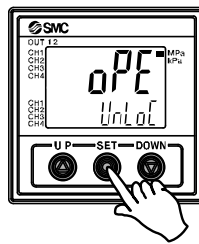

(2) Select the key-locking/un-locking with UP or DOWN button, and press the SET button to set.

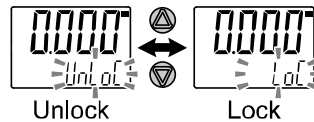

## <Operation – With security code input ->

### •Locking

- (1) Press the SET button for 5 seconds or longer in measurement mode. When [oPE] is displayed on the main display, release the button.

The current setting [LoC] or [UnLoC] will be displayed on the sub display.

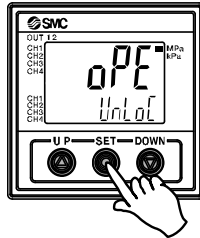

- (2) Select the key [LoC] with UP or DOWN button, and press the SET button to set.

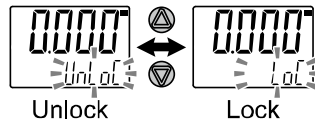

### •Unlocking

- (1) Press the SET button for 5 seconds or longer in measurement mode. When [oPE] is displayed on the main display, release the button.

The current setting [LoC] or [UnLoC] will be displayed on the sub display.

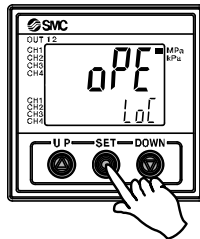

- (2) Select the un-locking [UnLoC] with UP or DOWN button. Setting is recognized by pressing the SET button, then security code is required.

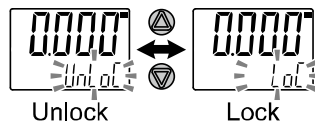

- (3) For instructions on how to enter the security code, refer to "How to input and change the security code" on page 74.

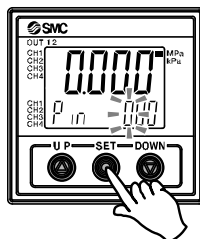

- (4) If inputted security code is correct, the indication of the main display changes to [UnLoC], and pressing the one of UP, SET or DOWN button releases key-lock and the measurement mode returns. If the security code entered is incorrect, [FAL] will be displayed, and the security code must be entered again. If the wrong security code is entered 3 times, [LoC] is displayed and the device returns to measurement mode.

● **How to input and change the security code**

The left most digit starts flashing.

Press the UP or DOWN button to select a value.

Press the SET button to make the next digit to the right flash.

(If the SET button is pressed at the last digit, the first digit will start flashing.)

After the setting is complete, Press and hold the SET button for 1 second or longer.

(If an operation is not performed for 30 seconds during input or change of the security code, it will return to measurement mode.)

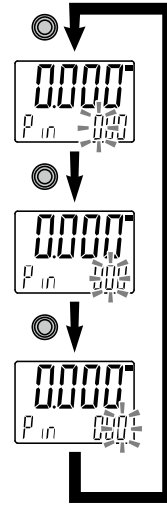

## IO-Link Specifications

### ■ Outline of IO-Link functions

#### ○ Communication function

This product can check the pressure measurement value, diagnostic information and switch output status using cyclic data communication via the IO-Link system.

#### ○ Product status monitoring function

This function monitors the product status via the IO-Link communication.

- Detects the error status (internal hardware error).
- Detects the warning conditions (measurement pressure error).

#### ○ Data storage function

The Data storage function stores the IO-Link device parameter settings to the IO-Link master.

With the IO-Link data storage function, the IO-Link device can be replaced easily without re-setting the equipment construction or setting parameters

When the device parameters are set and downloaded to the device using the IO-Link setting tool, the parameters in the downloaded device will be activated.

After that, these parameters are uploaded to the data storage in the master by stem command (back-up communication command).

When the device is replaced with the same type of IO-Link device due to failure, the parameter settings stored in the master are downloaded automatically, device can be operated with the parameter settings of the previous device.

Device parameter setting is applicable to 3 types of back-up levels of the master setting ("Inactive", "back-up/Restore", "Restore").

"Back-up" implies the activation of upload and "restore" implies download.

### ■ Communication specifications

IO-Link type	Device
IO-Link version	V.1.1
Communication speed	COM2 (38.4 kbps)
Min. cycle time	4.8 ms
Process data length	Input Data: 10 byte, Output Data: 0 byte
On request data communication	Available
Data storage function	Available
Event function	Available

## ■ Process data

Process data is the data which is exchanged periodically between the master and device.  
This product process data consists of switch output status, error diagnostics and pressure gauge measurement value.

(Refer to the table below.)

Bit offset	Item	Notes
0	CH1: OUT1 output	0: OFF 1: ON
1	CH1: OUT2 output	0: OFF 1: ON
2	CH2: OUT1 output	0: OFF 1: ON
3	CH2: OUT2 output	0: OFF 1: ON
4	CH3: OUT1 output	0: OFF 1: ON
5	CH3: OUT2 output	0: OFF 1: ON
6	CH4: OUT1 output	0: OFF 1: ON
7	CH4: OUT2 output	0: OFF 1: ON
8	CH1: Diagnostics	0: OFF 1: ON Out of CH1 display range (When HHH and LLL are displayed).
9	CH2: Diagnostics	0: OFF 1: ON Out of CH2 display range (When HHH and LLL are displayed).
10	CH3: Diagnostics	0: OFF 1: ON Out of CH3 display range (When HHH and LLL are displayed).
11	CH4: Diagnostics	0: OFF 1: ON Out of CH4 display range (When HHH and LLL are displayed).
12 to 14	—	Reservation
15	Diagnosis (Error)	0: OFF 1: ON When errors are generated (when Er** is displayed).
16 to 31	CH4: Measurement value	With symbol 16 bit
32 to 47	CH3: Measurement value	With symbol 16 bit
48 to 63	CH2: Measurement value	With symbol 16 bit
64 to 79	CH1: Measurement value	With symbol 16 bit

Bit offset	79	78	77	76	75	74	73	72	71	70	69	68	67	66	65	64
Item	CH1: Measurement value															

Bit offset	63	62	61	60	59	58	57	56	55	54	53	52	51	50	49	48
Item	CH2: Measurement value															

Bit offset	47	46	45	44	43	43	41	40	39	38	37	36	35	34	33	32
Item	CH3: Measurement value															

Bit offset	31	30	29	28	27	26	25	24	23	22	21	20	19	18	17	16
Item	CH4: Measurement value															

Bit offset	15	14	13	12	11	10	9	8	7	6	5	4	3	2	1	0
Item	Diagnosis error	Reservation			Diagnosis CH4	Diagnosis CH3	Diagnosis CH2	Diagnosis CH1	OUT2 CH4	OUT1 CH4	OUT2 CH3	OUT1 CH3	OUT2 CH2	OUT1 CH2	OUT2 CH1	OUT1 CH1

- The process data of this product is Big-Endian type.  
When the transmission method of the upper communication is Little-Endian, the byte order will be changed.  
Refer to the table below for the Endian type of the major upper communication.

Endian type	Upper communication protocol
Big-Endian type	Such as PROFIBUS and PROFINET
Little-Endian type	Such as EtherNET/IP, EtherCAT and CC-Link IE Field.

○Unit specification and measurement value (PD)

Range	Unit	Rated pressure range			Display / settable range		
		A	to	B	C	to	D
2 kPa (0.002)	kPa	0	to	2.000	-0.200	to	2.100
	Pa	0	to	2000	-200	to	2100
	Mbar	0	to	20.00	-2.00	to	21.00
	Psi	0	to	0.2901	-0.029	to	0.305
	mmH <sub>2</sub> O	0	to	203.94	-20.4	to	214.1
	Pressure gauge measurement value (PD)	0	to	4000	-400	to	4200
-101 kPa (-0.1)	MPa	0	to	-0.101	0.010	to	-0.105
	kPa	0	to	-101.0	10.0	to	-105.0
	kgf/cm <sup>2</sup>	0	to	-1.0299	0.102	to	-1.071
	bar	0	to	-1.010	0.100	to	-1.050
	psi	0	to	-14.649	1.45	to	-15.23
	inchHg	0	to	-29.83	3.0	to	-31.0
	mmHg	0	to	-757.6	75	to	-788
	Pressure gauge measurement value (PD)	0	to	4000	-396	to	4158
±100 kPa (F0.1)	MPa	-0.1000	to	0.1000	-0.105	to	0.105
	kPa	-100.0	to	100.0	-105.0	to	105.0
	kgf/cm <sup>2</sup>	-1.0197	to	1.0197	-1.071	to	1.071
	bar	-1.000	to	1.000	-1.050	to	1.050
	psi	-14.504	to	14.504	-15.22	to	15.22
	inchHg	-29.53	to	29.53	-31.0	to	31.0
	mmHg	-750.1	to	750.1	-788	to	788
	Pressure gauge measurement value (PD)	-4000	to	4000	-4200	to	4200
100 kPa (0.1)	MPa	0	to	0.100	-0.010	to	0.105
	kPa	0	to	100.0	-10.0	to	105.0
	kgf/cm <sup>2</sup>	0	to	1.0197	-0.102	to	1.071
	bar	0	to	1.000	-0.100	to	1.050
	psi	0	to	14.504	-1.45	to	15.23
	Pressure gauge measurement value (PD)	0	to	4000	-400	to	4200
500 kPa (0.5)	MPa	0	to	0.500	-0.050	to	0.525
	kPa	0	to	500.0	-50	to	525
	kgf/cm <sup>2</sup>	0	to	5.099	-0.51	to	5.35
	bar	0	to	5.000	-0.50	to	5.25
	psi	0	to	72.52	-7.3	to	76.1
	Pressure gauge measurement value (PD)	0	to	4000	-400	to	4200
1 MPa (1.0)	MPa	0	to	1.000	-0.105	to	1.050
	kPa	0	to	1000	-105	to	1050
	kgf/cm <sup>2</sup>	0	to	10.197	-1.07	to	10.71
	bar	0	to	10.00	-1.05	to	10.50
	psi	0	to	145.04	-15.2	to	152.3
	Pressure gauge measurement value (PD)	0	to	4000	-420	to	4200

\*: The figure below describes the relationship between the measurement value (PD) and pressure value at Range: -101 kPa and Unit: kPa.

○Unit specification and measurement value (PD) (continued)

Range	Unit	Rated pressure range		Display / settable range	
1.6 MPa (1.6)	MPa	0	to 1.600	-0.105	to 1.680
	kPa	0	to 1600	-105	to 1680
	kgf/cm <sup>2</sup>	0	to 16.315	-1.07	to 17.13
	bar	0	to 16.00	-1.05	to 16.80
	psi	0	to 232.06	-15.3	to 243.7
	Pressure gauge measurement value (PD)	0	to 4000	-263	to 4200
2 MPa (2.0)	MPa	0	to 2.000	-0.105	to 2.100
	kPa	0	to 2000	-105	to 2100
	kgf/cm <sup>2</sup>	0	to 20.394	-1.07	to 21.41
	bar	0	to 20.00	-1.05	to 21.00
	psi	0	to 290.08	-15.2	to 304.6
	Pressure gauge measurement value (PD)	0	to 4000	-210	to 4200
5 MPa (5.0)	MPa	0	to 5.000	-0.25	to 5.25
	kgf/cm <sup>2</sup>	0	to 50.99	-2.5	to 53.5
	bar	0	to 50.00	-2.5	to 52.5
	psi	0	to 725.2	-36	to 761
	Pressure gauge measurement value (PD)	0	to 4000	-200	to 4200
10 MPa (10.0)	MPa	0	to 10.00	-0.50	to 10.50
	kgf/cm <sup>2</sup>	0	to 101.97	-5.1	to 107.1
	bar	0	to 100.00	-5.0	to 105.0
	psi	0	to 1450.4	-73	to 1523
	Pressure gauge measurement value (PD)	0	to 4000	-200	to 4200
20 MPa (20.0)	MPa	0	to 20.00	-1.00	to 21.00
	kgf/cm <sup>2</sup>	0	to 203.94	-10.2	to 214.1
	bar	0	to 200.0	-10.0	to 210.0
	psi	0	to 2900.8	-146	to 3046
	Pressure gauge measurement value (PD)	0	to 4000	-200	to 4200
25 MPa (25.0)	MPa	0	to 25.00	-1.26	to 26.26
	kgf/cm <sup>2</sup>	0	to 254.92	-12.8	to 267.6
	bar	0	to 250.0	-12.6	to 262.6
	psi	0	to 3626.0	-182	to 3808
	Pressure gauge measurement value (PD)	0	to 4000	-200	to 4200
USER	-	ULo	to UHi	ULo -5%F.S.	to UHi +5%F.S.
	Pressure gauge measurement value (PD)	0	to 4000	-200	to 4200

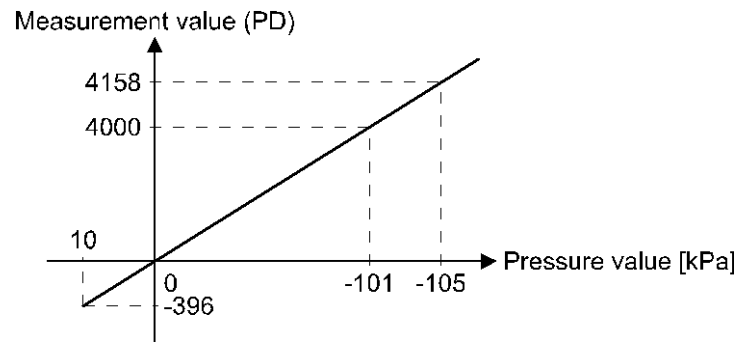

Relationship between the measurement value (PD) and pressure value (Range: -101 kPa, Unit: kPa)



○ Conversion formula of the process data and pressure gauge measurement value

**(1) Conversion formula from the process data to the pressure gauge measurement value:**

$$Pr = a \times (PD) + b$$

**(2) Conversion formula from the pressure gauge measurement value to the process data:**

$$(PD) = (Pr - b) / a$$

Pr: Pressure gauge measurement value and set value

PD: Measurement value (process data)

a: Inclination

b: Intercept

[Inclination and intercept to the unit specification]

Range	Unit	Inclination a	Intercept b
2 kPa (0.002)	kPa	0.005	0
	Pa	0.5	0
	mbar	0.005	0
	psi	0.000072525	0
	mmH <sub>2</sub> O	0.050985	0
-101 kPa (-0.1)	MPa	-0.00002525	0
	kPa	-0.02525	0
	kgf/cm <sup>2</sup>	-0.000257475	0
	bar	-0.0002525	0
	psi	-0.00366225	0
	inchHg	-0.0074575	0
	mmHg	-0.1894	0
±100 kPa (F0.1)	MPa	0.000025	0
	kPa	0.025	0
	kgf/cm <sup>2</sup>	0.000254925	0
	bar	0.00025	0
	psi	0.003626	0
	inchHg	0.073825	0
	mmHg	0.187525	0
100 kPa (0.1)	MPa	0.000025	0
	kPa	0.025	0
	kgf/cm <sup>2</sup>	0.000254925	0
	bar	0.00025	0
	psi	0.003626	0

[Inclination and intercept to the unit specification] (continued)

Range	Unit	Inclination a	Intercept b
500 kPa (0.5)	MPa	0.000125	0
	kPa	0.125	0
	kgf/cm <sup>2</sup>	0.00127475	0
	bar	0.00125	0
	psi	0.01813	0
1 MPa (1.0)	MPa	0.00025	0
	kPa	0.25	0
	kgf/cm <sup>2</sup>	0.00254925	0
	bar	0.0025	0
	psi	0.03626	0
1.6 MPa (1.6)	MPa	0.0004	0
	kPa	0.4	0
	kgf/cm <sup>2</sup>	0.00407875	0
	bar	0.004	0
	psi	0.05802	0
2.0 MPa (2.0)	MPa	0.0005	0
	kPa	0.5	0
	kgf/cm <sup>2</sup>	0.0050985	0
	bar	0.05	0
	psi	0.07252	0
5.0 MPa (5.0)	MPa	0.00125	0
	kgf/cm <sup>2</sup>	0.0127475	0
	bar	0.0125	0
	psi	0.1813	0
10.0 MPa (10.0)	MPa	0.0025	0
	kgf/cm <sup>2</sup>	0.0254925	0
	bar	0.025	0
	psi	0.3626	0
20.0 MPa (20.0)	MPa	0.005	0
	kgf/cm <sup>2</sup>	0.050985	0
	bar	0.05	0
	psi	0.7252	0
25.0 MPa (25.0)	MPa	0.00625	0
	kgf/cm <sup>2</sup>	0.06373	0
	bar	0.0625	0
	psi	0.9065	0

[Calculation example]

**(1) Conversion from the process data to the pressure measurement value  
(For range: -101 kPa, unit specification kPa and PD=2000)**

$$\begin{aligned}Pr &= a \times (PD) + b \\ &= -0.02525 \times 2000 + 0 \\ &= -50.5 \text{ [kPa]}\end{aligned}$$

**(2) Conversion from the pressure measurement value to the process data  
(For range: -101 kPa, unit specification kPa and Pr=-75.0[kPa])**

$$\begin{aligned}(PD) &= (Pr - b) / a \\ &= [-75.0 - (0)] / (-0.02525) \\ &= 2970\end{aligned}$$

## ■IO-Link parameter setting

### ○IODD file

IODD (I/O Device Description) is a definition file which provides all properties and parameters required for establishing functions and communication of the device.

IODD includes the main IODD file and a set of image files such as vendor logo, device picture and device icon.

The IODD file is shown below.

Product No.	IODD file *1
PSE202A-# PSE203A-#	SMC-PSE202A-yyyymmdd-IODD1.1

\*1: "yyyymmdd" indicates the file preparation date. yyyy is the year, mm is the month and dd is the date.

The IODD file can be downloaded from the SMC Web site (<https://www.smcworld.com>).

### ○Service data

The tables below indicates the parameters which can be read or written by simple access parameter (direct parameters page) and ISDU parameters which are applicable to various parameters and commands.

\*: The parameter data of this product is the Big Endian type.

When the transmission method of the upper communication is Little-Endian, the byte order will be changed.

#### ●Direct parameters page 1

DPP1 address	Access	Parameter name	Initial value (dec)	Contents
0x07	R	Vendor ID	0x0083(131)	"SMC Corporation"
0x08				
0x09	R	Device ID	0x000154(340)	"PSE202A"
0x0A				"PSE202A-M"
0x0B				"PSE203A"
				"PSE203A-M"

•ISDU parameters

Index (dec)	Sub index	Access *1	Parameters	Initial value	Remarks
0x0002 (2)	0	W	System command	–	Refer to "System command" on page 85.
0x000C (12)	0	R/W	Device access lock	0x0000	Refer to "Device access lock parameter" on page 86.
0x0010 (16)	0	R	Vendor name	SMC Corporation	
0x0011 (17)	0	R	Vendor text	www.smcworld.com	
0x0012 (18)	0	R	Product name	Example PSE202A	
0x0013 (19)	0	R	Product ID	Example PSE202A	
0x0014 (20)	0	R	Product text	MONITOR	
0x0015 (21)	0	R	Serial number	Example : "xxxxxxxx"	•Initial value is indicated as 8-digit. •16 octets fixed character string
0x0016 (22)	0	R	Hardware version	HW-Vx.y	x: Large revision number y: Small revision number
0x0017 (23)	0	R	Software version	FW-Vx.y	x: Large revision number y: Small revision number
0x0018 (24)	0	R/W *2	Application specific tag	ALL "*"	Can be changed arbitrarily
0x0024 (36)	0	R	Device status parameter	–	Refer to "Device status parameter" on page 86.
0x0025 (37)	0	R	Device detailed state parameter	–	Refer to "Device detailed state parameter" on page 87.
0x0028 (40)	0	R	Process data input	–	The latest value of process data can be read.

\*1: R: Read, W: Write

\*2: When using IODD, only the personnel who are registered as Maintenance/Specialist can Write data.

- System command (index 2)

In the ISDU index 0x0002 SystemCommand (system command), the command shown in the table below will be issued.

The button of each system command is displayed on the IO-Link setting tool (excluding "ParamDownloadStore").

Click the button to send the system command to the product.

Writable commands are shown below.

Data type: 8 bit UInteger

Value (dec)	State definition	Description
0x80(128)	Device Reset	Reset the device.
0x81(129)	Application Reset	Clear the peak/bottom value of all channels.
0x82(130)	Restore Factory Settings	Restore the set values to the factory settings.
0xA0(160)	All Zero Clear	Conduct a zero-clear of all channels.
0xA1(161)	CH1 Zero Clear	Conduct a zero-clear of CH1.
0xA2(162)	CH2 Zero Clear	Conduct a zero-clear of CH2.
0xA3(163)	CH3 Zero Clear	Conduct a zero-clear of CH3.
0xA4(164)	CH4 Zero Clear	Conduct a zero-clear of CH4.
0xAB(171)	CH1 Peak Bottom Clear	Clear the peak/bottom value of CH1.
0xAC(172)	CH2 Peak Bottom Clear	Clear the peak/bottom value of CH2.
0xAD(173)	CH3 Peak Bottom Clear	Clear the peak/bottom value of CH3.
0xAE(174)	CH4 Peak Bottom Clear	Clear the peak/bottom value of CH4.

\*1: When using IODD, the personnel who are registered as Maintenance/Specialist can write other than CH\* Peak Bottom Clear (0xAB-0xAE).

- Device access lock parameter (index 12)

The contents are as follows.

Data type: 16 bit Record

Value (dec)	Contents
0x0000 (0)	Key lock release, DS unlock (Initial value)
0x0002 (2)	Key lock release, DS lock
0x0008 (8)	Key lock, DS unlock
0x000A (10)	Key lock, DS lock

**[Key lock]**

Function that prevents changes to the settings of the product (disables button operation). Even when key lock function is activated, settings can be changed by IO-Link communication. Restoration by data storage (overwriting parameter data) can be performed.

**[Lock data storage (DS lock)]**

Data storage function is disabled by locking the Data storage". In this case, access will be denied for backup and restoration of data storage.

- Device state parameters (index 36)

Readable device states are as follows.

Data type: 8 bit UInteger

Value	State definition	Description
0x00 (0)	Normal operation	—
0x01 (1)	Maintenance inspection required	Not available
0x02 (2)	Outside specification range	The measurement pressure range has exceeded the upper limit
0x03 (3)	Function check	Not available
0x04 (4)	Failure	Internal failure of digital pressure switch

• Device detail status parameters (index 37)

Detailed event contents of readable device status are as follows.

Array	Event content	Event classification		Event code
		Definition	Value	
1	Internal product malfunction	Error	0xF4	0x8D01
2	Internal product malfunction	Error	0xF4	0x8D02
3	Internal product malfunction	Error	0xF4	0x8D03
4	Internal product malfunction	Error	0xF4	0x8D04
5	Internal product malfunction	Error	0xF4	0x8D05
6	Internal product malfunction	Error	0xF4	0x8D06
7	Internal product malfunction	Error	0xF4	0x8D07
8	OUT 1 over current error of CH2	Error	0xF4	0x8CE1
9	OUT 1 over current error of CH3	Error	0xF4	0x8CE2
10	OUT 1 over current error of CH4	Error	0xF4	0x8CE3
11	OUT 2 over current error of CH1	Error	0xF4	0x8CC0
12	Outside the measurement upper limit of CH1	warning	0xE4	0x8D60
13	Outside the measurement upper limit of CH2	warning	0xE4	0x8D61
14	Outside the measurement upper limit of CH3	warning	0xE4	0x8D62
15	Outside the measurement upper limit of CH4	warning	0xE4	0x8D63
16	-	-	0x00	0x0000
17	-	-	0x00	0x0000
18	Data storage upload request	notification	0x54	0xFF91



●Product individual parameters

Index (dec)				Sub index	Access *1	Parameter	Data storage *2	Data type *3	Initial value (dec)	Remarks
CH1	CH2	CH3	CH4							
0x03E8 (1000)	0x03E9 (1001)	0x03EA (1002)	0x03EB (1003)	0	R/W	Unit (Selection of display unit)	Y	U8	0x01 (1)	Setting of display unit. It might not be possible to select depending on the range. (Rejection response) 0: MPa 1: kPa 2: Pa 3: kgf/cm <sup>2</sup> 4: bar 5: mbar 6: psi 7: inchHg 8: mmHg 9: mmH <sub>2</sub> O
0x03F2 (1010)	0x03F3 (1011)	0x03F4 (1012)	0x03F5 (1013)	0	R/W	CoL (Selection of display colour)	Y	U8	0x02 (2)	Setting of display colour. 0: rEd (Constantly red) 1: Grn (Constantly green) 2: 1SoG (OUT1 turns green at ON) 3: 1Sor (OUT1 turns red at ON) 4: 2SoG (OUT2 turns green at ON) 5: 2Sor (OUT2 turns red at ON)
0x0410 (1040)	0x0411 (1041)	0x0412 (1042)	0x0413 (1043)	1	R/W	rAnG (Selection of connection range)	Y	U8	0x01 (1)	Set the connection range **4 0: 0.002 (2kPa) 1: -0.1 (-101kPa) 2: F0.1 (±100kPa) 3: 0.1 (100kPa) 4: 0.5 (500kPa) 5: 1.0 (1MPa) 6: 1.6 (1.6MPa) 7: 2.0 (2MPa) 8: 5.0 (5MPa) 9: 10.0 (10MPa) 10: 20.0 (20MPa) 11: 25.0 (25MPa) 12: USEr (Range added by the user)
				2	R/W	Udot (Minimum unit for range [USEr])	Y	U8	0x06 (6)	Set the minimum unit when "range added by the user" is selected. 0: 0.001 1: 0.002 2: 0.01 3: 0.02 4: 0.1 5: 0.2 6: 1 7: 2
				3	R/W	ULo (Rated lower limit for range [USEr])	Y	S16	0x0000 (0)	Set the rated lower limit when "range added by the user" is selected. -1500 ~ 1500
				4	R/W	UHi (Rated upper limit for range [USEr])	Y	S16	0x03E8 (1000)	Set the rated upper limit when "range added by the user" is selected. -1500 ~ 1500

●Product individual parameters (continued)

Index (dec)				Sub index	Access <sup>+1</sup>	Parameter	Data storage <sup>+2</sup>	Data type <sup>+3</sup>	Initial value (dec)	Remarks
CH1	CH2	CH3	CH4							
0x041A (1050)				1	R/W	Channel select	Y	U8	0x00 (0)	Set the channel to be displayed. 0: CH1 1: CH2 2: CH3 3: CH4
				2	R/W	Channel scan mode	Y	U8	0x00 (0)	Set the channel scan mode. 0: OFF 1: ON
				3	R/W	diF (Differential pressure check mode)	Y	U8	0x00 (0)	Set the differential pressure check mode. 0: OFF 1: ON
0x04BA (1210)	0x04BB (1211)	0x04BC (1212)	0x04BD (1213)	1	R/W	oUt1 (Selection of OUT1 output operation mode)	Y	U8	0x00 (0)	Setting of OUT1 output mode. 0: HYS (Hysteresis) 1: Wind (Window comparator) 2: Err (Error output) 3: OFF (Output OFF)
				2	R/W	1ot (Selection of OUT1 output type)	Y	U8	0x00 (0)	Setting of OUT1 output type. 0: 1_P (Normal output) 1: 1_n (Reverse output)
0x04C4 (1220)	0x04C5 (1221)	0x04C6 (1222)	0x04C7 (1223)	1	R/W	P_1 (Selection of OUT1 output set value)	Y	S16	0x07D0 (2000)	Selection of OUT1 output set value. (page 77 to 78)
				2	R/W	H_1 (Setting of OUT1 hysteresis)	Y	U16	0x00C8 (200)	Setting of OUT1 hysteresis. (page 77 to 78)
				3	R/W	P1L (Lower limit of the OUT1 window comparator)	Y	S16	0x04B0 (1200)	Setting of OUT1 lower limit of window comparator. (page 77 to 78)
				4	R/W	P1H (Upper limit of the OUT1 window comparator)	Y	S16	0x0960 (2400)	Setting of OUT1 upper limit of window comparator. (page 77 to 78)
				5	R/W	WH1 (Setting of OUT1 window comparator hysteresis)	Y	U16	0x0190 (400)	Setting of OUT1 window comparator hysteresis. (page 77 to 78)
				6	R/W	dtH1 (OUT1 delay time at ON)	Y	U16	0x0000 (0)	Setting of OUT1 delay time at ON. 0x0000 ~ 0x1770 (0~6000) 0.01 s increment
				7	R/W	dtL1 (OUT1 delay time at OFF)	Y	U16	0x0000 (0)	Setting of OUT1 delay time at OFF. 0x0000 ~ 0x1770 (0 ~ 6000) 0.01 s increment

●Product individual parameters (continued)

Index (dec)				Sub index	Access <sup>+1</sup>	Parameter	Data storage <sup>+2</sup>	Data type <sup>+3</sup>	Initial value (dec)	Remarks
CH1	CH2	CH3	CH4							
0x0582 (1410)	0x0583 (1411)	0x0584 (1412)	0x0585 (1413)	1	R/W	oUt2 (Selection of OUT2 output operation mode)	Y	U8	0x00 (0)	Setting of OUT2 output mode. 0: HYS (Hysteresis) 1: WinD (Window comparator) 2: Err (Error output) 3: oFF (Output OFF)
				2	R/W	2ot (Selection of OUT2 output type)	Y	U8	0x00 (0)	Setting of OUT2 output type. 0: 1_P (Normal output) 1: 1_n (Reverse output)
0x058C (1420)	0x058D (1421)	0x058E (1422)	0x058F (1423)	1	R/W	P_2 (Selection of OUT2 output set value)	Y	S16	0x07D0 (2000)	Selection of OUT2 output set value. (page 77 to 78)
				2	R/W	H_2 (Setting of OUT2 hysteresis)	Y	U16	0x00C8 (200)	Setting of OUT2 hysteresis. (page 77 to 78)
				3	R/W	P2L (Lower limit of the OUT2 window comparator)	Y	S16	0x04B0 (1200)	Setting of OUT2 lower limit of window comparator. (page 77 to 78)
				4	R/W	P2H (Upper limit of the OUT2 window comparator)	Y	S16	0x0960 (2400)	Setting of OUT2 upper limit of window comparator. (page 77 to 78)
				5	R/W	WH2 (Setting of OUT2 window comparator hysteresis)	Y	U16	0x0190 (400)	Setting of OUT2 window comparator hysteresis. (page 77 to 78)
				6	R/W	dtH2 (OUT2 delay time at ON)	Y	U16	0x0000 (0)	Setting of OUT1 delay time at ON. 0x0000 ~ 0x1770 (0 ~ 6000) 0.01 s increment
				7	R/W	dtL2 (OUT2 delay time at OFF)	Y	U16	0x0000 (0)	Setting of OUT1 delay time at OFF. 0x0000 ~ 0x1770 (0 ~ 6000) 0.01 s increment
0x0708 (1800)	0x0709 (1801)	0x070A (1802)	0x070B (1803)	0	R/W	FIL (Digital filter)	Y	U16	0x0000 (0)	Setting of digital filter. 0x0000 ~ 0x0BB8 (0 ~ 3000) 0.01 s increment
0x0712 (1810)	0x0713 (1811)	0x0714 (1812)	0x0715 (1813)	0	R/W	FSC (Setting of display value fine adjustment)	N	S16	0x0000 (0)	Displayed pressure value can be adjusted within ±5%R.D. 0xFFCE ~ 0x0032 (-50 ~ 50) 0.1% increment

●Product individual parameters (continued)

Index (dec)				Sub index	Access *1	Parameter	Data storage *2	Data type *3	Initial value (dec)	Remarks
CH1	CH2	CH3	CH4							
0x07D0 (2000)	0x07D1 (2001)	0x07D2 (2002)	0x07D3 (2003)	1	R/W	SUB (Setting of sub display option)	Y	U8	0x00 (0)	Set the sub display option. 0: Std 1: dUAL (2 value display) 2: o1Lv (OUT1 level bar) 3: o2Lv (OUT2 level bar) 4: Line (Line name) 5: oFF (No display)
				2	R/W	Std (Std default setting)	Y	U8	0x00 (0)	Refer to Table "selection of display items during std setting".
				3	R/W	dUAL (Left set value in the [dUAL] mode)	Y	U8	0x00 (0)	Refer to Table "Selection of display items during 2 value setting".
				4	R/W	dUAL (Right set value in the [dUAL] mode)	Y	U8	0x01 (1)	
0x0974 (2420)	0x0975 (2421)	0x0976 (2422)	0x0977 (2423)	1	R/W	Line name 1st letter (11 SEG)	Y	U8	0x00 (0)	Refer to Figure "Line name communication data (11 seg)".
				2	R/W	Line name 2nd letter (11 SEG)	Y	U8	0x00 (0)	Refer to Figure "Line name communication data (11 seg)".
				3	R/W	Line name 3rd letter	Y	U8	0x00 (0)	Refer to Figure "Line name communication data (7 seg)".
				4	R/W	Line name 4th letter	Y	U8	0x00 (0)	Refer to Figure "Line name communication data (7 seg)".
				5	R/W	Line name 5th letter	Y	U8	0x00 (0)	Refer to Figure "Line name communication data (7 seg)".
				6	R/W	Line name 6th letter (11 SEG)	Y	U8	0x00 (0)	Refer to Figure "Line name communication data (11 seg)".
				7	R/W	Line name 7th letter (11 SEG)	Y	U8	0x00 (0)	Refer to Figure "Line name communication data (11 seg)".
				8	R/W	Line name 8th letter	Y	U8	0x00 (0)	Refer to Figure "Line name communication data (7 seg)".
				9	R/W	Line name 9th letter	Y	U8	0x00 (0)	Refer to Figure "Line name communication data (7 seg)".
0x097E (2430)	0x097F (2431)	0x0980 (2432)	0x0981 (2433)	1	R/W	Line name 1st letter dot	Y	U8	0x00 (0)	0: OFF (dot OFF) 1: ON (dot ON)
				2	R/W	Line name 2nd letter dot	Y	U8	0x00 (0)	0: OFF (dot OFF) 1: ON (dot ON)
				3	R/W	Line name 3rd letter dot	Y	U8	0x00 (0)	0: OFF (dot OFF) 1: ON (dot ON)
				4	R/W	Line name 4th letter dot	Y	U8	0x00 (0)	0: OFF (dot OFF) 1: ON (dot ON)
				5	R/W	Line name 5th letter dot	Y	U8	0x00 (0)	0: OFF (dot OFF) 1: ON (dot ON)
				6	R/W	Line name 6th letter dot	Y	U8	0x00 (0)	0: OFF (dot OFF) 1: ON (dot ON)
				7	R/W	Line name 7th letter dot	Y	U8	0x00 (0)	0: OFF (dot OFF) 1: ON (dot ON)
				8	R/W	Line name 8th letter dot	Y	U8	0x00 (0)	0: OFF (dot OFF) 1: ON (dot ON)
0x07DA (2010)	0x07DB (2011)	0x07DC (2012)	0x07DD (2013)	0	R/W	drE (Setting of display value resolution)	Y	U8	0x00 (0)	Setting of display value resolution 0: Normal resolution 1: Lower resolution (1/10)

●Product individual parameters (continued)

Index (dec)				Sub index	Access <sup>+1</sup>	Parameter	Data storage <sup>+2</sup>	Data type <sup>+3</sup>	Initial value (dec)	Remarks
CH1	CH2	CH3	CH4							
0x07EE (2030)	0x07EF (2031)	0x07F0 (2032)	0x07F1 (2033)	0	R/W	CUT (Zero cut-off setting)	Y	U8	0x00 (0)	Display value around 0 is displayed as 0. Settable values 0x00 ~ 0x0A (0 ~ 10) 1.0% unit
0x0960 (2400)				0	R/W	Eco (ECO mode)	Y	U8	0x00 (0)	Set the economy mode. 0: OFF 1: ON
0x096A (2410)				1	R/W <sup>*5</sup>	Pin (Security code Used/Not used)	Y	U8	0x00 (0)	Setting of the security code to used or not used 0: OFF 1: ON
				2	R/W <sup>*5</sup>	PinCode (Security code)	Y	U16	0x0000 (0)	Setting of security code 0x0000 ~ 0x03E7 (0 ~ 999)
0x1F40 (8000)	0x1F41 (8001)	0x1F42 (8002)	0x1F43 (8003)	0	R	Process data Conversion formula Inclination a	N	F32	-	Refer to table "Inclination and intercept to the unit specification". (page 80)
0x1F4A (8010)	0x1F4B (8011)	0x1F4C (8012)	0x1F4D (8013)	0	R	Process data Conversion formula Intercept b	N	F32	-	
0x1F54 (8020)	0x1F55 (8021)	0x1F56 (8022)	0x1F57 (8023)	0	R	H_Hi (Peak value)	N	U16	-	Refer to process data on page 76 to 80.
0x1F5E (8030)	0x1F5F (8031)	0x1F60 (8032)	0x1F61 (8033)	0	R	H_Lo (Bottom value)	N	U16	-	

\*1: "R" means Read and "W" means Write.

\*1: When using IODD, only the personnel who are registered as Maintenance/Specialist can write other than the channel select and channel scan (0x41A).

\*2: Refer to the table below for the symbol.

\*3: "Y" indicates that the parameter setting data is saved to the master, and "N" indicates that the parameter is not saved.

Symbol	Data type (IO-Link standard)	Data length Bit [byte]	Description
U8	UIntegerT	8[1]	Unsigned integer)
U16		16[2]	
S16	IntegerT	16[2]	Signed integer
F32	Float32T	32[4]	Floating point number

\*4: If the unit is not available when the unit is changed, a rejection response will be generated. In that case, change the range and unit to an available unit. After that, it is possible to change the setting. (for single parameter).

Example: When changing the range and unit from the range 5 MPa, unit MPa to range 2 kPa, unit kPa.

When the unit kPa is not available in range 5 MPa, and MPa is not available in range 2 kPa, a rejection response is generated.

Therefore, the range should be changed from 5 MPa to 1 MPa. As the unit kPa is available in the range 1 MPa, it is possible to change the range and unit to range 2 kPa and unit kPa.

\*5: When using IODD, only the personnel who are registered as Maintenance/Specialist can read and write data.

[Selection of display items during standard setting]

Value	Setting content		Supplemental information
0	OUT1	HYS mode set value	When the value which does not match the OUT* output mode setting is written, acknowledgment is sent and [Std - - -] is displayed.
1		HYS mode hysteresis	
2		Wind mode lower side set value	
3		Wind mode upper side set value	
4		Wind mode hysteresis	
5		Err mode	
6		oFF mode	
7	OUT2	HYS mode set value	
8		HYS mode hysteresis	
9		Wind mode lower side set value	
10		Wind mode upper side set value	
11		Wind mode hysteresis	
12		Err mode	
13		oFF mode	
14	Pressure bottom value		
15	Pressure peak value		
16	Reservation		
17	SW output mode / communication mode display		

[Selection of display items during 2 value setting]

Value	Setting content		Selection of display items during 2 value setting		Supplemental information
			Left side	Right side	
0	OUT1	HYS mode set value	●	●	When the value which does not match the OUT* output mode setting is written, acknowledgment is sent and [- - -] is displayed.
1		HYS mode hysteresis	●	●	
2		Wind mode lower side set value	●	●	
3		Wind mode upper side set value	●	●	
4		Wind mode hysteresis	●	●	
5	OUT2	HYS mode set value	●	●	
6		HYS mode hysteresis	●	●	
7		Wind mode lower side set value	●	●	
8		Wind mode upper side set value	●	●	
9		Wind mode hysteresis	●	●	
10	Pressure peak value		●	×	
11	Pressure bottom value		×	●	
12	Reservation		×	×	
13	Pressure display unit		●	●	
14	Range specification		●	●	
15	OUT1 output mode / output style		●	×	
16	OUT2 output mode / output style		×	●	
17	Line name (left side 4 digits, right side 5 digits)		●	●	
18	Display channel		●	●	
19	CH1 measurement display value		●	●	
20	CH2 measurement display value		●	●	
21	CH3 measurement display value		●	●	
22	CH4 measurement display value		●	●	
23	Display OFF (No display)		●	●	

●: Settable                      ×: Not settable (negative acknowledge)

Value (16 Hex number)		00	01	02	03	04	05	06	07	08	09	0A	0B	0C	0D	0E	0F
Display letter	7seg																
	11seg																
Value (16 Hex number)		10	11	12	13	14	15	16	17	18	19	1A	1B	1C	1D	1E	1F
Display letter	7seg																
	11seg																
Value (16 Hex number)		20	21	22	23	24	25	26	27	28	29	2A	2B	2C	2D	2E	2F
Display letter	7seg																
	11seg																
Supplementary information	: Do not work																

Line name communication data



## Maintenance

### How to reset the product after a power cut or forcible de-energizing

The setting of the product will be retained as it was before a power cut or de-energizing. The output condition is also basically recovered to that before a power cut or de-energizing, but may change depending on the operating environment. Therefore, check the safety of the whole installation before operating the product. If the installation is using accurate control, wait until the product has warmed up (approximately 10 to 15 minutes).

## Forgotten the security code

Use the procedure below when the security code has been forgotten.

### <Operation>

Press the SET button for 5 seconds or longer in measurement mode. When [oPE] is displayed on the main display, release the button.

The current setting [LoC] or [UnLoC] will be displayed on the sub display.

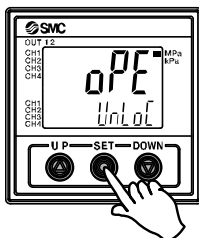

Press the UP and DOWN buttons simultaneously for 5 second or longer.

Press the SET and DOWN buttons simultaneously for 5 second or longer.

\*: Display is not changed.

(If another operation is performed or no operation is performed for 30 seconds, the display will return to measurement mode.)

Press the UP and SET buttons simultaneously for 5 second or longer.

Security code is displayed, and the security code change mode is available.

(If an operation is not performed for 30 seconds, the display will return to measurement mode.)



Decide on the security code referring to "How to input and change the security code" on page [74](#).

When input is completed, the selected security code flashes.

After checking the security code is as required, press the SET button for 1 second or longer.

Return to measurement mode.

At this time, if the UP or DOWN buttons are pressed, any security code changes are lost, and the change of security code must be repeated.

# Troubleshooting

## ○Troubleshooting

When any failure occurs with this product, the following chart can be used to identify the cause of the failure. If a cause applicable to the troubles cannot be identified and normal operation is recovered by replacement with a new product, this indicates that the product itself was faulty. Problems with the product may be due to the operating environment (installation etc). Please consult SMC.

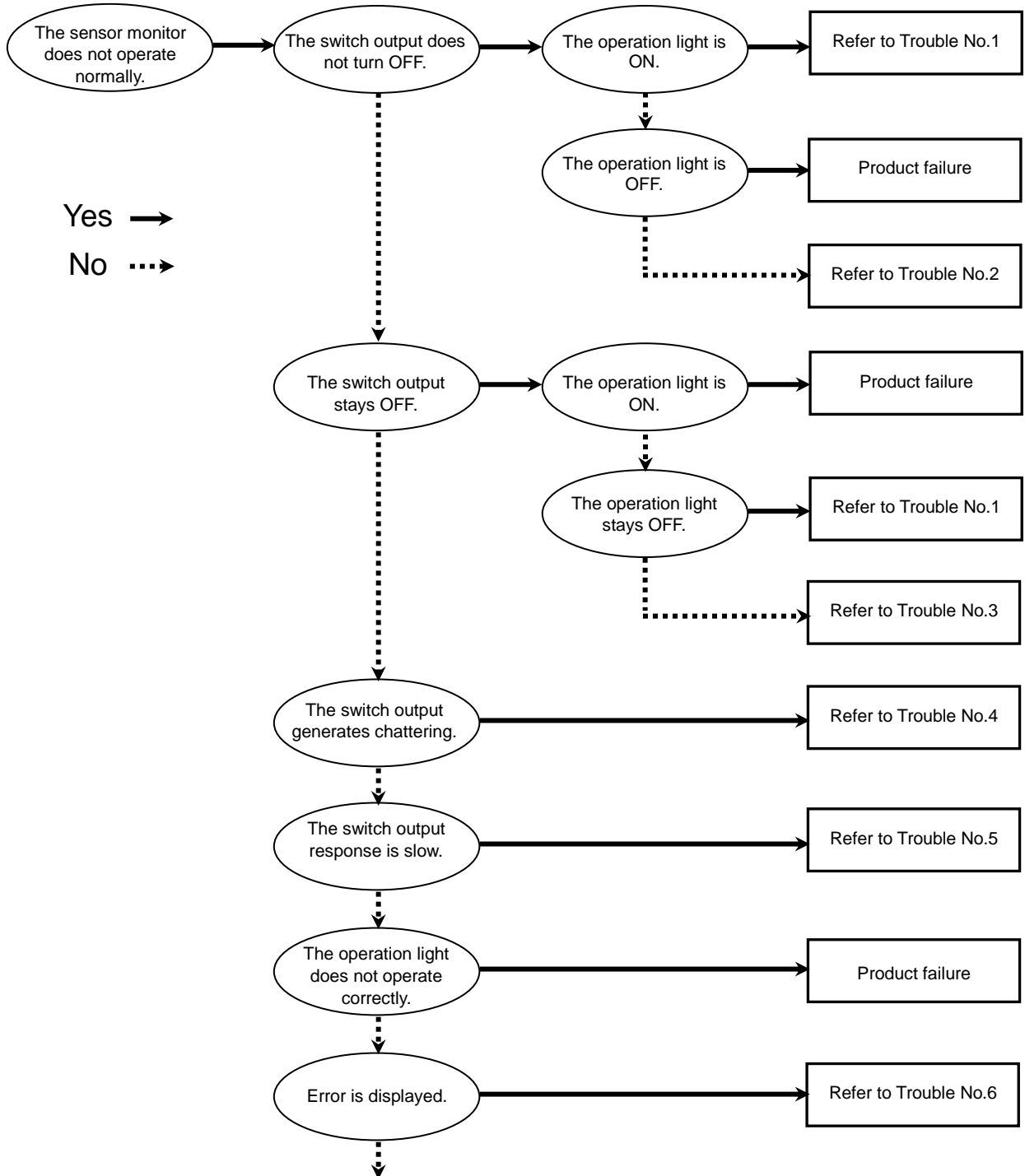

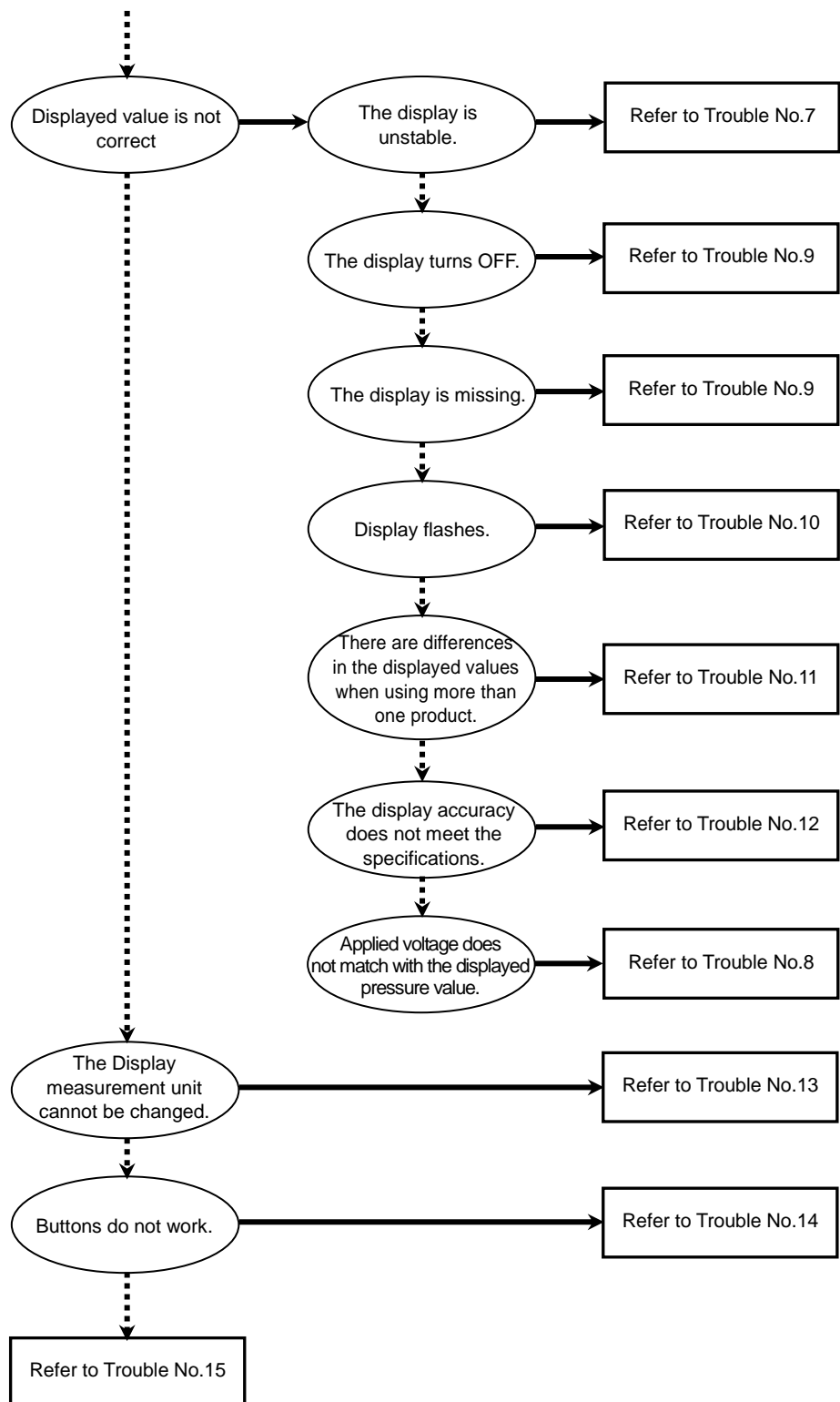

○Troubleshooting list

Problem No.	Problem	Problem possible causes	Investigation method	Countermeasures
1	<ul style="list-style-type: none"> <li>•The switch output does not turn OFF. The operation light stays ON.</li> <li>•The switch output does not turn ON. The operation light stays OFF.</li> </ul>	Incorrect pressure setting	(1) Check the set pressure value. (2) Check the settings of the operation mode, hysteresis and output type. (In hysteresis mode or window comparator mode, and normal output/ reversed output)	(1) Adjust the set pressure value. (2) Set the operation mode, hysteresis and output type again.
		Product failure		Replace the product.
2	The switch output does not turn OFF. The operation light is normal.	Incorrect wiring	Check the output wiring. Check if the load is directly connected to DC(+) or DC(-).	Check and correct the wiring.
		Product failure		Replace the product.
3	The switch output is OFF. The operation light is normal.	Incorrect wiring	Check the output wiring. Check if the load is directly connected to DC(+) or DC(-).	Check and correct the wiring.
		Model selection	Check if PNP output is used when NPN should have been selected, or the other way around.	Revise the model selection (output specification).
		Lead wire broken	Check if there is bending stress applied to any part of the lead wire. (bending radius, tensile force to the lead wire)	Correct the wiring. (Reduce the tensile force or increase the bending radius.)
		Product failure		Replace the product.
4	The switch output generates chattering.	Incorrect wiring	Check the wiring. Check if the brown and blue wires are connected to DC(+) and DC(-) respectively, and if the output line is secure (contact failure).	Correct the connection on the power cord and the plug.
		Incorrect pressure setting	(1) Check the set pressure value. (2) Check if the hysteresis range is small. (3) Check the delay time setting. Check if the delay time is too short.	(1) Adjust the set pressure value. (2) Make the hysteresis wider. (3) Set the delay time again.
		Product failure		Replace the product.
5	The switch output response is slow.	Incorrect pressure setting	Check the set pressure value. Check if the detected pressure and the set pressure values are the same or are too close.	Adjust the set pressure value. Ensure the set pressure value is not too close to the detected pressure value.

Problem No.	Problem	Problem possible causes	Investigation method	Countermeasures
6	<ul style="list-style-type: none"> <li>•Over current error (Er1) is displayed.</li> <li>•System error (Er0, 4, 6, 7, 8, 9) is displayed.</li> <li>•"HHH" is displayed.</li> <li>•"LLL" is displayed.</li> <li>• Residual pressure error (Er3) is displayed.</li> </ul>	Excess current was applied to the output (Er1)	<ol style="list-style-type: none"> <li>(1) Check if the output current is 80 mA or more.</li> <li>(2) Check if the connected load complies with the specification. Check if the load is short circuited.</li> <li>(3) Check if the relay without surge protection is connected.</li> <li>(4) Check if the wiring is in the same route as (or bundled together with) a high-voltage or power line.</li> </ol>	<ol style="list-style-type: none"> <li>(1)(2) Connect the appropriate load.</li> <li>(3) Use a relay with a surge voltage suppressor or take measures to prevent surge.</li> <li>(4) Separate the wiring from the high-voltage and/or power line.</li> </ol>
		Incorrect internal data processing of the product (Er0, 4, 6, 7, 8 and 9)	<ol style="list-style-type: none"> <li>(1) Check if there is noise interference (such as static electricity). Check if there is a noise source nearby.</li> <li>(2) Check if the power supply voltage is in the range 12 to 24 VDC <math>\pm 10\%</math>.</li> </ol>	<ol style="list-style-type: none"> <li>(1) Remove the noise and the noise source (or take measures to prevent noise interference), and reset the product (or turn off and then turn back on the power supply).</li> <li>(2) Supply power in the range 12 to 24 VDC <math>\pm 10\%</math>.</li> </ol>
		Applied pressure is higher than the upper limit (HHH)	<ol style="list-style-type: none"> <li>(1) Check if the pressure exceeds the upper limit of the set pressure range.</li> <li>(2) Check if foreign matter has entered the piping.</li> </ol>	<ol style="list-style-type: none"> <li>(1) Reset applied pressure to a level within the set pressure range.</li> <li>(2) Take measures to prevent foreign matter from entering the piping.</li> </ol>
		Applied pressure is lower than the lower limit (LLL)	<ol style="list-style-type: none"> <li>(1) Check if the pressure exceeds the lower limit of the set pressure range.</li> <li>(2) Check if foreign matter has entered the piping.</li> </ol>	<ol style="list-style-type: none"> <li>(1) Reset applied pressure to a level within the set pressure range.</li> <li>(2) Take measures to prevent foreign matter from entering the piping.</li> </ol>
		Pressure is not atmospheric pressure when zero-clear is performed (Er3)	Check if the pressure exceeded the atmospheric pressure within $\pm 7\%$ F.S. ( $\pm 3.5\%$ F.S. for compound pressure).	Release the applied pressure to atmospheric pressure, and retry the zero clear operation.
		Product failure		Replace the product.
		7	The display is unstable.	Incorrect power supply
Incorrect wiring	Check the power supply wiring. Check if the brown and blue wires are connected to DC(+) and DC(-) respectively, and if the wiring is secure.			Check and correct the wiring.
Factory line pressure is not stable	Check if the factory line pressure is changing.			If the fluctuation is not acceptable, the number of digits (display sensitivity) can be reduced by changing the display resolution. Digital filter setting may improve the condition.

Problem No.	Problem	Problem possible causes	Investigation method	Countermeasures
8	Applied voltage does not match with the displayed pressure value.	Incorrect pressure range setting	Check the pressure range setting. Check if the connected pressure sensor and the set pressure range are correct.	Select the correct pressure range.
9	<ul style="list-style-type: none"> <li>•The display turns OFF.</li> <li>•Part of the display is missing.</li> </ul>	Incorrect power supply	Check if the power supply voltage is in the range 12 to 24 VDC $\pm$ 10%.	Supply power in the range 12 to 24 VDC $\pm$ 10%.
		Incorrect wiring	Check the power supply wiring. Check if the brown and blue wires are connected to DC(+) and DC(-) respectively, and if the wiring is secure.	Check and correct the wiring.
		Power saving mode	Check if power saving mode is selected.	Select the power saving mode again.
		Product failure		Replace the product.
10	Display flashes.	Incorrect wiring	(1) Check the power supply wiring. (2) Check if there is bending stress applied to any part of the lead wire.	(1) Check and correct the wiring. (2) Correct the wiring (bend radius and stress).
11	Pressure display is unstable when products are in close proximity to each other.	Variation within the display accuracy range	Check if the variation is within the display accuracy range.	Use the fine adjustment mode to adjust the display if the variation is within the display accuracy range.
		Product failure		Replace the product.
12	The display accuracy does not meet the specifications.	Foreign matter entered	Confirmed foreign matter entry or sticking to the piping port.	Use 5 $\mu$ m of filter to prevent foreign matter from entering or sticking. Discharge the condensate of the filter periodically.
		Air or liquid leakage	Check if air or liquid are leaking from the piping.	Rework the piping. If the tightening torque is exceeded, the mounting screws, brackets and the product may be damaged.
		Warming up inadequate	Check if the product satisfies the specified accuracy 10 minutes after supplying power.	After energizing, the display and output can drift. For precise pressure detection, allow the product to warm up for 10 to 15 minutes.
		Product failure		Replace the product.

Problem No.	Problem	Problem possible causes	Investigation method	Countermeasures
13	Display measurement unit cannot be changed.	Model selection (model selected does not have units selection function)	Check if the product number printed on the product indicates units selection function type.	Unit s selection function is not available for fixed to SI units type. (kPa↔MPa is available) *: The units selection function is not for use in Japan due to a new measurement law. *: Fixed to SI units: kPa, MPa
		Product failure		Replace the product.
14	Buttons do not work.	Key-lock mode is activated	Check if the key-lock function is turned on.	Check the key-lock function.
		Product failure		Replace the product.
15	The operation is unstable. (chattering)	Effect of line pressure fluctuation because hysteresis is too narrow or delay time of the switch is too short	(1) Check the set pressure values (hysteresis) (2) Check the delay time.	(1) Adjust the set pressure value. (2) Change the response time setting.
		Incorrect wiring/broken lead wire	(1) Check the power supply wiring. (2) Check if there is bending stress applied to any part of the lead wire. (bending radius, tensile force to the lead wire)	(1) Check and correct the wiring. (2) Correct the wiring. (Reduce the tensile force or increase the bending radius.)
		Product failure		Replace the product.

○Troubleshooting (IO-Link communication function)

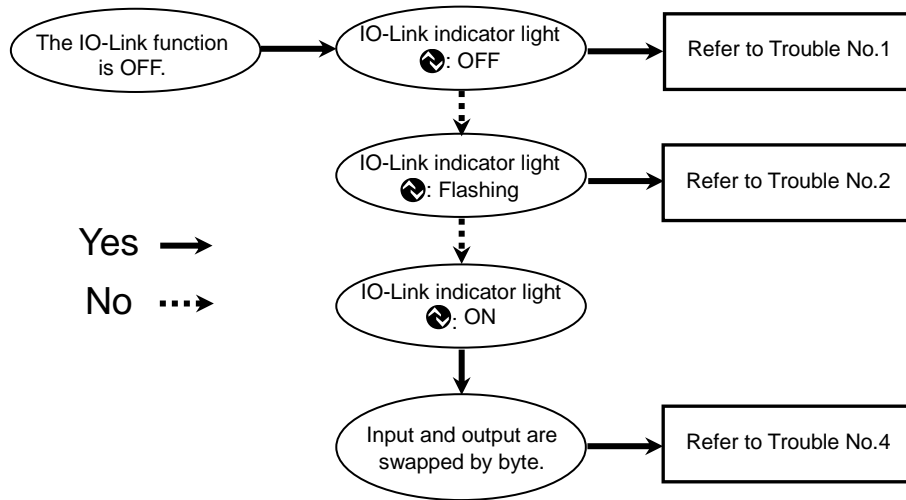



○ Troubleshooting list (IO-Link communication)

Problem No.	Problem	Description	Problem possible causes	Investigation method	Countermeasures
1	IO-Link indicator light 🔴: OFF	—	incorrect wiring	Check the connection of the connector.	Correct the cable wiring.
		—	Power supply error from the IO-Link master	Check the power supply voltage from the IO-Link master.	Supply 18 to 30 VDC to the IO-Link master.
2	IO-Link indicator light 🔴: Flashing	<i>mode ***</i>	Communication is not established. IO-Link wiring failure	Check the connection and cable condition of the IO-Link cable.	Additionally tighten the IO-Link cable. (Replace the cable if it is broken.)
		<i>Er 15</i> <i>V 1.0</i>	IO-Link master and product version are not matched.	Check the IO-Link version of the master and device.	Align the master IO-Link version to the device. *1
		<i>mode start</i> <i>mode pre</i>	Communication mode is not transferred to the Operation mode.	Check the setting of the data storage access lock and data storage backup level of the master.	Release the data storage access lock. Or deactivate the setting of the data storage backup level of the master port.
		<i>mode loc</i>	Backup and restore required during data storage lock	Check the data storage lock.	Release the data storage lock.
3	Data is swapped by byte.	—	Program data assignment is incorrect.	Check that the Endian type on the master upper level communication transmission format is Big Endian type or Little Endian type.	Assign the program data based on the Endian type of the transmission format of the master upper level communication. Or set to the master byte swap setting. (Refer to page 76 for the Endian type of the upper level communication.)

\*1: When the product is connected to the master with version "V1.0", error Er15 is generated.



o IO-Link status list

Sub display indication	Details
<i>ds READ</i>	Data storage uploading
<i>ds WRITE</i>	Data storage downloading
<i>bp READ</i>	Block parameter uploading
<i>bp WRITE</i>	Block parameter downloading
<i>ini 000</i>	Receiving restore Factory Setting
<i>rPB 000</i>	Receiving Peak Bottom Clear
<i>ZERO 000</i>	Receiving Zero Clear
<i>rAPP 000</i>	Receiving Application Reset

\*: When the operation is completed, the display will return to normal.

○Error indication function

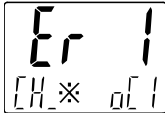
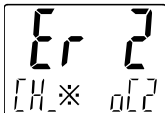
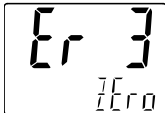
This function is to display error location and content when a problem or error has occurred.

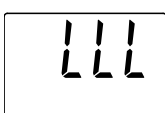
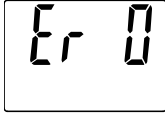
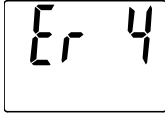
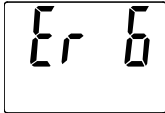
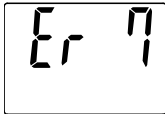
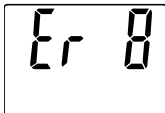
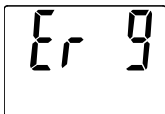
Error	Error displayed	Description	Measures
Over current error	 	<p>The switch output load current is 80 mA or more.            ※ indicates channel with error.</p>	<p>Turn the power off and remove the cause of the over current. Then supply the power again.</p>
Residual pressure error		<p>During zero clear operation, pressure greater than <math>\pm 7\%</math>F.S. (<math>\pm 3.5\%</math>F.S. for compound pressure) is present. Note that the mode is returned to measurement mode automatically 1 second later. The zero clear range varies by <math>\pm 1\%</math>F.S. due to variation between individual products.</p>	<p>Release the applied pressure to atmospheric pressure, and retry the zero clear operation.</p>
Pressurizing error		<p>Pressure exceeding the upper limit of the set pressure range is applied.</p>	<p>Reset applied pressure to a level within the set pressure range. Check the sensor connection and wiring.</p>
		<p>Pressure exceeding the lower limit of the set pressure range is applied. Sensor is not connected or wired incorrectly.</p>	
System error	     	<p>Displayed if an internal data error has occurred.</p>	<p>Turn the power off and on again. If the failure cannot be solved, contact SMC.</p>

If the error cannot be reset after the above measures are taken, or errors other than above are displayed, please contact SMC.

# Specifications

Product No.		PSE20#A series	
Pressure spec.	Rated pressure range	Refer to the table for each pressure specification (page 109)	
	Display/set pressure range		
	Display/min. setting unit		
Electric spec.	Power supply voltage	Used as switch output device	12 to 24 VDC ( $\pm 10\%$ ), and voltage ripple (p-p) 10% at max.
		Used as IO-Link device	18 to 30 VDC, including ripple (p-p) 10%
	Power supply voltage	12 to 24 VDC ( $\pm 10\%$ ), and ripple (p-p) 10% at max.	
	Current consumption	55 mA or less	
	Protection	Polarity protection	
	Power supply voltage for sensor	Power supply voltage: -1.5 V	
Accuracy	Display accuracy	$\pm 0.5\%$ F.S. $\pm 1$ digit (at ambient temperature $25 \pm 3$ °C)	
	Repeatability	$\pm 0.1\%$ F.S. $\pm 1$ digit	
	Temperature characteristics	$\pm 0.5\%$ F.S. (25 °C standard)	
Switch output	Output type	NPN or PNP open collector output 5 output	
	Output mode	Hysteresis, window comparator, error output, output OFF	
	Switch operation	Normal output, reversed output	
	Maximum load current	80 mA	
	Maximum applied voltage (NPN output)	30 VDC	
	Internal voltage drop (Residual voltage)	1.5 V or less (Load current 80 mA)	
	Delay time *2	5 ms or less, variable from 0 to 60 s/0.01 s increments	
	Hysteresis	Variable from zero *3	
Sensor input	Input type	Voltage input: 1 to 5 VDC (Input impedance: 1 M $\Omega$ )	
	Number of inputs	4 input	
	Connection method	e-CON	
	Protection	Over voltage protection (up to a voltage of 26.4 VDC)	
Display	Unit *4	MPa, kPa, Pa, kgf/cm <sup>2</sup> , bar, mbar, psi, inHg, mmHg, mmH <sub>2</sub> O (depends on selected range)	
	Display type	LCD	
	Number of displays	3 (1 main display and 2 sub displays)	
	Display colour	Main display: Red/Green, Sub display: Orange	
	Number of display digits	Main display: 4 digits 7 segment Sub display (left): 4 digits (partially 11-segments, 7-segments for other) Sub display (right): 5 digits (partially 11-segments, 7-segments for other)	
	Operation light	LED is ON when switch output is ON (OUT1, OUT2: Orange)	
Digital filter *5		Variable from 0 to 30 s/0.01 s increments	

Product No.		PSE20#A series
Environment	Enclosure	IP65 (front side only when the panel is mounted), IP40 for others *6
	Withstand voltage	1000 VAC for 1 minute between terminals and housing
	Insulation resistance	50 MΩ or more between terminals and housing (with 500 VDC megger)
	Ambient temperature range	Operation: 0 to 50 °C, Storage: -10 to 60 °C (No condensation)
	Operating humidity range	Operation and storage: 35 to 85%RH (No condensation)
Standard		CE marked (EMC directive/RoHS directive)
Weight	Body	51 g (power supply and output cables are excluded)
	Power supply/output cable	60 g
	e-CON connector (1pc.)	2 g

\*1: Monitor will be broken if Vcc of the sensor input connector and 0 V side.

\*2: Value without digital filter (at 0 ms).

\*3: If the applied pressure fluctuates around the set value, the hysteresis must be set to a value more than the amount of fluctuation or chattering will occur.

\*4: This setting is only available for models with the units selection function. Only MPa, kPa or Pa is available for models without this function.

\*5: The response time indicates when the set value is 90% in relation to the step input.

\*6: When □48 mm conversion adapter is used, it satisfies IP40.

\*7: Any products with tiny scratches, smears, or variations in the display colour or brightness, which does not affect the performance of the product, are verified as conforming products.

○Cable specification

Conductor area		0.15 mm <sup>2</sup> (AWG26)
Insulator	Outside diameter	0.9 mm
Sheath	Finished outside diameter	φ4.8

○Table for each pressure specification

Applicable SMC pressure sensor	Rated pressure range	Display/set pressure range	Display/min. setting unit
PSE550	0 to 2 kPa	-0.2 to to 2.1 kPa	0.001 kPa
PSE531, PSE541, PSE561	0 to -101 kPa	10 to -105 kPa	0.1 kPa
PSE533, PSE543, PSE563, PSE573	-100 to 100 kPa	-105 to 105 kPa	0.1 kPa
PSE532	0 to 100 kPa	-10 to 105 kPa	0.1 kPa
PSE564, PSE574	0 to 500 kPa	-50 to 525 kPa	1 kPa
PSE530, PSE540, PSE560, PSE570	0 to 1 MPa	-0.105 to 1.05 MPa	0.001 MPa
PSE575	0 to 2 MPa	-0.105 to 2.1 MPa	0.001 MPa
PSE576	0 to 5 MPa	-0.1 to 5.25 MPa	0.01 MPa
PSE577	0 to 10 MPa	-0.1 to 10.5 MPa	0.01 MPa

○Communication specification (During IO-Link mode)

IO-Link type	Device
IO-Link version	V1.1
Communication speed	COM2 (38.4 kbps)
Configuration file	IODD file *6
Min. cycle time	4.8 ms
Process data length	Input Data: 10 byte, Output Data: 0 byte
On request data communication	Available
Data storage function	Available
Event function	Available
Vendor ID	131 (0x0083)
Device ID	340 (0x000154)

\*6: The configuration file can be downloaded from the SMC website, <https://www.smcworld.com>

## ■Dimensions

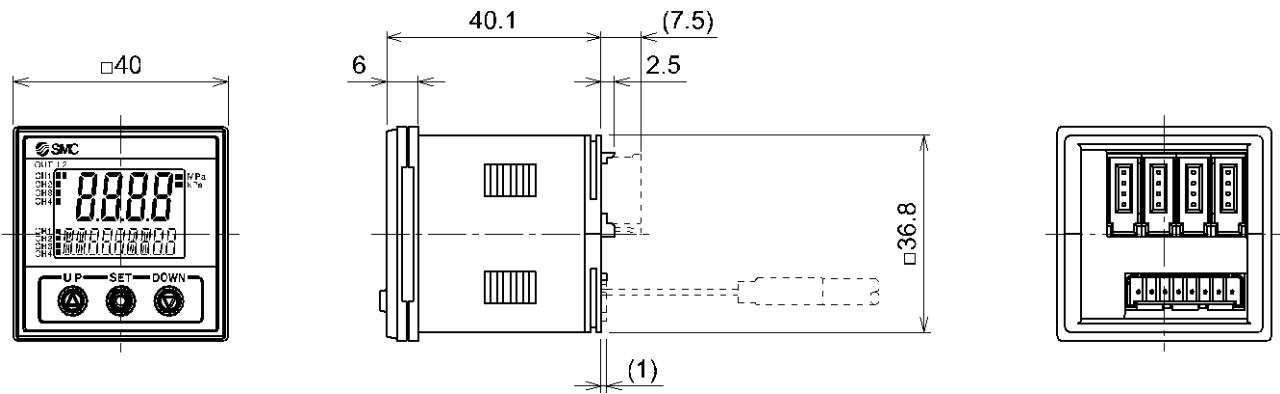

## ○Power supply/output cable

- ZS-26-L

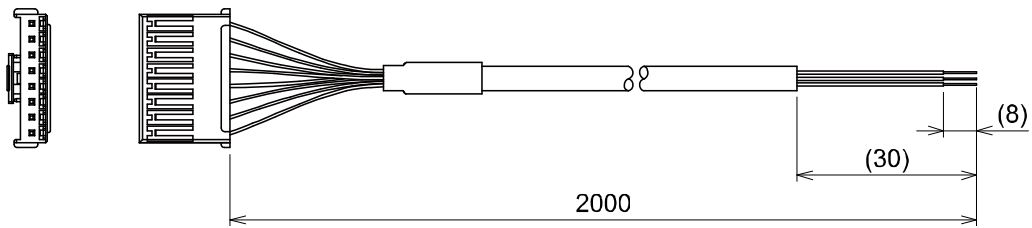

Revision history
A: Contents are added [November 2019]

# SMC Corporation

4-14-1, Sotokanda, Chiyoda-ku, Tokyo 101-0021 JAPAN

Tel: + 81 3 5207 8249 Fax: +81 3 5298 5362

URL <https://www.smcworld.com>

---

Note: Specifications are subject to change without prior notice and any obligation on the part of the manufacturer.  
© 2019 SMC Corporation All Rights Reserved

