



# Operation Manual

PRODUCT NAME

Economy Valve

MODEL / Series / Product Number

VEX5 Series

**SMC Corporation**

# Contents

Safety Instructions	-----	2, 3
Design / Selection	-----	4
Mounting	-----	5
Piping	-----	5
Wiring	-----	5
Lubrication	-----	5
Air Supply	-----	5, 6
Operating environment	-----	6
Maintenance	-----	6
Specific Product Precautions	-----	7 to 9
Troubleshooting	-----	10, 11



# Safety Instructions

These safety instructions are intended to prevent hazardous situations and/or equipment damage. These instructions indicate the level of potential hazard with the labels of "Caution," "Warning" or "Danger." They are all important notes for safety and must be followed in addition to International Standards (ISO/IEC)\*1), and other safety regulations.

\*1) ISO 4414: Pneumatic fluid power -- General rules relating to systems.

ISO 4413: Hydraulic fluid power -- General rules relating to systems.

IEC 60204-1: Safety of machinery -- Electrical equipment of machines .(Part 1: General requirements)

ISO 10218: Manipulating industrial robots -Safety.

etc.



## Caution

**Caution** indicates a hazard with a low level of risk which, if not avoided, could result in minor or moderate injury.



## Warning

**Warning** indicates a hazard with a medium level of risk which, if not avoided, could result in death or serious injury.



## Danger

**Danger** indicates a hazard with a high level of risk which, if not avoided, will result in death or serious injury.

## Warning

### **1. The compatibility of the product is the responsibility of the person who designs the equipment or decides its specifications.**

Since the product specified here is used under various operating conditions, its compatibility with specific equipment must be decided by the person who designs the equipment or decides its specifications based on necessary analysis and test results.

The expected performance and safety assurance of the equipment will be the responsibility of the person who has determined its compatibility with the product.

This person should also continuously review all specifications of the product referring to its latest catalog information, with a view to giving due consideration to any possibility of equipment failure when configuring the equipment.

### **2. Only personnel with appropriate training should operate machinery and equipment.**

The product specified here may become unsafe if handled incorrectly.

The assembly, operation and maintenance of machines or equipment including our products must be performed by an operator who is appropriately trained and experienced.

### **3. Do not service or attempt to remove product and machinery/equipment until safety is confirmed.**

1. The inspection and maintenance of machinery/equipment should only be performed after measures to prevent falling or runaway of the driven objects have been confirmed.

2. When the product is to be removed, confirm that the safety measures as mentioned above are implemented and the power from any appropriate source is cut, and read and understand the specific product precautions of all relevant products carefully.

3. Before machinery/equipment is restarted, take measures to prevent unexpected operation and malfunction.

### **4. Contact SMC beforehand and take special consideration of safety measures if the product is to be used in any of the following conditions.**

1. Conditions and environments outside of the given specifications, or use outdoors or in a place exposed to direct sunlight.

2. Installation on equipment in conjunction with atomic energy, railways, air navigation, space, shipping, vehicles, military, medical treatment, combustion and recreation, or equipment in contact with food and beverages, emergency stop circuits, clutch and brake circuits in press applications, safety equipment or other applications unsuitable for the standard specifications described in the product catalog.

3. An application which could have negative effects on people, property, or animals requiring special safety analysis.

4. Use in an interlock circuit, which requires the provision of double interlock for possible failure by using a mechanical protective function, and periodical checks to confirm proper operation.



# Safety Instructions

## Caution

### **1. The product is provided for use in manufacturing industries.**

The product herein described is basically provided for peaceful use in manufacturing industries.

If considering using the product in other industries, consult SMC beforehand and exchange specifications or a contract if necessary.

If anything is unclear, contact your nearest sales branch.

## **Limited warranty and Disclaimer/Compliance Requirements**

The product used is subject to the following “Limited warranty and Disclaimer” and “Compliance Requirements”.

Read and accept them before using the product.

### **Limited warranty and Disclaimer**

**1. The warranty period of the product is 1 year in service or 1.5 years after the product is delivered, whichever is first.\*2)**

**Also, the product may have specified durability, running distance or replacement parts. Please consult your nearest sales branch.**

**2. For any failure or damage reported within the warranty period which is clearly our responsibility, a replacement product or necessary parts will be provided.**

**This limited warranty applies only to our product independently, and not to any other damage incurred due to the failure of the product.**

**3. Prior to using SMC products, please read and understand the warranty terms and disclaimers noted in the specified catalog for the particular products.**

**\*2) Vacuum pads are excluded from this 1 year warranty.**

**A vacuum pad is a consumable part, so it is warranted for a year after it is delivered.**

**Also, even within the warranty period, the wear of a product due to the use of the vacuum pad or failure due to the deterioration of rubber material are not covered by the limited warranty.**

### **Compliance Requirements**

**1. The use of SMC products with production equipment for the manufacture of weapons of mass destruction(WMD) or any other weapon is strictly prohibited.**

**2. The exports of SMC products or technology from one country to another are governed by the relevant security laws and regulation of the countries involved in the transaction. Prior to the shipment of a SMC product to another country, assure that all local rules governing that export are known and followed.**

## Caution

**SMC products are not intended for use as instruments for legal metrology.**

Measurement instruments that SMC manufactures or sells have not been qualified by type approval tests relevant to the metrology (measurement) laws of each country.

Therefore, SMC products cannot be used for business or certification ordained by the metrology (measurement) laws of each country.



# 3 Port Solenoid Valves / Precautions 1

Be sure to read before handling

### Design / Selection

#### Warning

##### 1. Confirm the specifications.

Products represented in this manual are designed only for use in compressed air systems.

Do not operate at pressures, temperatures, etc., beyond the range of specifications, as this can cause damage or malfunction. Please contact SMC when using a fluid other than compressed air.

We do not guarantee against any damage if the product is used outside of the specification range.

##### 2. Actuator drive

When an actuator, such as a cylinder, is to be driven using a valve, take appropriate measures (such as the installation of a cover or the restricting of access to the product) to prevent potential danger caused by actuator operation.

##### 3. Intermediate stops

It is difficult for products like cylinders to make a piston stop at the required intermediate position accurately and precisely due to the compressibility of air.

Furthermore, since valves and cylinders are not guaranteed for zero air leakage, it may not be possible to hold a stopped position for an extended period of time.

Please contact SMC if it is necessary to hold a stopped position for an extended period of time.

##### 4. Holding pressure

Since valves are subject to air leakage, they cannot be used for applications such as holding pressure in a pressure vessel.

##### 5. Not suitable for use as an emergency shutoff valve, etc.

The valves presented in this catalog are not designed for safety applications (e.g. emergency shutoff valve). If the valves are used in such applications, additional safety measures should be adopted.

##### 6. Release of residual pressure

For maintenance and inspection purposes install a system for releasing residual pressure.

##### 7. Ventilation

Provide ventilation when using a valve in a confined area, such as in a closed control panel. For example, install a ventilation opening, etc., in order to prevent pressure from increasing inside of the confined area and to release the heat generated by the valve.

##### 8. Extended periods of continuous energization

- If a valve is continuously energized for an extended period of time, heat generated by the coil assembly may result in reduced performance and shorter service life, or have adverse effects on peripheral equipment. If the total energizing time per day is expected to be longer than the total de-energizing time per day, use a valve which has DC type, power saving type or long loading time type.

Depending on the operating conditions, it may be possible to use valves which are not mentioned above. Please contact us.

- When the valve is mounted onto a control panel, take measures against radiation in order to keep the valve temperature within the specified range.

##### 9. Do not disassemble the product or make any modifications, including additional machining.

Doing so may cause human injury and/or an accident.

#### Caution

##### 1. Leakage voltage

Take note that the leakage voltage will increase when a resistor is used in parallel with a switching element or when a C-R circuit (surge voltage suppressor) is used for protecting a switching device because of the leakage voltage passing through the C-R circuit. The suppressor residual leakage voltage should be as follows.

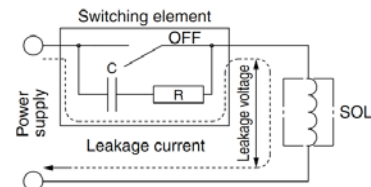

##### DC coil

3% or less of the rated voltage

##### AC coil

20% or less of the rated voltage

##### 2. Solenoid valve drive for AC with a solid state output (SSR, TRIAC output, etc.)

###### 1) Current leakage

When using a snubber circuit (C-R element) for surge protection of the output, a very small amount of electrical current will continue to flow even during the OFF state.

This results in the valve not returning. In a situation where the tolerance is exceeded, as in the above case, take measures to install a bleeder resistor.

###### 2) Minimum allowable load amount (Min. load current)

When the consumption current of a valve is less than the output's minimum allowable load volume or the margin is small, the output may not switch normally. Please contact SMC.

##### 3. Surge voltage suppressor

If a surge protection circuit contains nonstandard diodes, such as Zener diodes or varistor, a residual voltage that is in proportion to the protective circuit and the rated voltage will remain. Therefore, take into consideration the surge voltage protection of the controller.

In the case of diodes, the residual voltage is approximately 1 V.

##### 4. Operation in low temperature conditions

It is possible to operate a valve in extreme temperatures, as low as 0°C. Take appropriate measures to avoid the freezing of drainage, moisture, etc., in low temperatures.

##### 5. Mounting orientation

Mounting orientation is not specified.



## VEX5 Series

# 3 Port Solenoid Valves / Precautions 2

Be sure to read before handling

### Mounting

#### ⚠ Warning

##### 1. Operation Manual (this copy)

Install the products and operate them only after reading the operation manual carefully and understanding its contents. Also, keep the manual where it can be referred to as necessary.

##### 2. Ensure sufficient space for maintenance activities.

When installing the products, allow access for maintenance and inspection.

##### 3. Tighten threads with the proper tightening torque.

When installing the products, follow the listed torque specifications.

##### 4. If air leakage increases or equipment does not operate properly, stop operation.

Check mounting conditions when air and power supplies are connected. Initial function and leakage tests should be performed after installation.

##### 5. Painting and coating

Warnings or specifications printed on or affixed to the product should not be erased, removed, or covered up.

Please consult with SMC before applying paint to resinous parts, as this may have an adverse effect due to the solvent in the paint.

### Piping

#### ⚠ Caution

##### 1. Preparation before piping

Before piping is connected, it should be thoroughly blown out with air (flushing) or washed to remove chips, cutting oil, and other debris from inside the pipe.

##### 2. Winding of sealant tape

When screwing piping or fittings into ports, ensure that chips from the pipe threads or sealing material do not enter the piping.

Also, if sealant tape is used, leave 1 thread ridge exposed at the end of the threads.

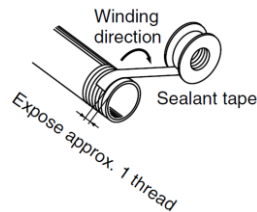

##### 3. Connection of piping and fittings

- For a fitting with sealant R or NPT, first, tighten it by hand, then use a suitable wrench to tighten the hexagonal portion of the body an additional two or three turns. For the tightening torque, refer to the table below.

Connection thread size (R, NPT)	Proper tightening torque (N·m)
1/8	3 to 5
1/4	8 to 12
3/8	15 to 20
1/2	20 to 25
3/4	28 to 30
1	36 to 38
1 1/4	40 to 42
1 1/2	48 to 50
2	48 to 50

- When using a fitting other than an SMC fitting, follow the instructions given by the fitting manufacturer.

##### 4. Piping to products

When connecting piping to the product, refer to the catalogue to avoid mistakes in the position of the supply port, etc.

### Wiring

#### ⚠ Caution

##### 1. Polarity

For a solenoid valve with DC type light / surge voltage suppressor, check the polarity when connecting.

If a mistake is made regarding the polarity, damage may occur to the diode in the valve, the switching element in the control device, power supply equipment, etc.

##### 2. Applied voltage

When electric power is connected to a solenoid valve, be careful to apply the proper voltage. Improper voltage may cause malfunction or coil damage.

##### 3. Check the connections.

Check if the connections are correct after completing all wiring.

### Lubrication

#### ⚠ Warning

1. The valve has been lubricated for life by the factory and does not require any further lubrication.

2. If a lubricant is used in the system, use class 1 turbine oil (no additives), ISO VG32. For details about lubricant manufacturers' brands, refer to the SMC website. Additionally, please contact SMC for details about class 2 turbine oil (with additives) ISO VG32.

Once lubricant is utilized within the system, since the original lubricant applied within the product during manufacturing will be washed away, please continue to supply lubrication to the system. Without continued lubrication, malfunctions could occur. If turbine oil is used, refer to the Safety Data Sheet (SDS) of the oil.

### Air Supply

#### ⚠ Warning

##### 1. Type of fluids

Please consult with SMC when using the product in applications other than compressed air.

##### 2. When there is a large amount of drainage

Compressed air containing a large amount of drainage can cause the malfunction of pneumatic equipment. An air dryer or water separator should be installed upstream from filters.

##### 3. Drain flushing

If condensation in the drain bowl is not emptied on a regular basis, the bowl will overflow. This may cause the malfunction of pneumatic equipment.

If the drain bowl is difficult to check and remove, the installation of a drain bowl with an auto drain option is recommended.

For compressed air quality, refer to the SMC Best Pneumatics No. 6 catalog.

##### 4. Use clean air.

Do not use compressed air that contains chemicals, synthetic oils that include organic solvents, salt, corrosive gases, etc., as it can cause damage or malfunction.



## VEX5 Series

# 3 Port Solenoid Valves / Precautions 3

Be sure to read before handling

### Air Supply

#### Caution

- 1. When extremely dry air is used as the fluid, degradation of the lubrication properties inside the equipment may occur, resulting in reduced reliability (or reduced service life) of the equipment. Please consult with SMC.**
- 2. Install an air filter.**  
Install an air filter upstream near the valve. Select an air filter with a filtration size of 5 µm or smaller.
- 3. Take measures to ensure air quality, such as by installing an aftercooler, air dryer, or water separator.**  
Compressed air that contains a large amount of drainage can cause the malfunction of pneumatic equipment, such as valves. Therefore, take appropriate measures to ensure air quality, such as by providing an aftercooler, air dryer, or water separator.
- 4. If an excessive amount of carbon powder is present, install a mist separator on the upstream side of the valve.**  
If excessive carbon dust is generated by the compressor, it may adhere to the inside of a valve and cause it to malfunction.  
For compressed air quality, refer to the SMC Best Pneumatics No. 6 catalog.

### Operating Environment

#### Warning

- 1. Do not use in an atmosphere containing corrosive gases, chemicals, sea water, water, water steam, or where there is direct contact with any of these.**
- 2. Do not use in an environment where flammable gas or explosive gas exists. Usage may cause a fire or explosion. The products do not have an explosion proof construction.**
- 3. Do not use in a place subject to heavy vibration and/or shock.**
- 4. The valve should not be exposed to prolonged sunlight. Use a protective cover.**
- 5. Remove any sources of excessive heat.**
- 6. If it is used in an environment where there is possible contact with oil, weld spatter, etc., exercise preventive measures.**
- 7. When the valve is mounted in a control panel or it's energized for a long period of time, make sure the ambient temperature is within the specifications of the valve.**

### Maintenance

#### Warning

- 1. Maintenance should be performed according to the procedure indicated in the Operation Manual (this copy).**  
If handled improperly, human injury and/or malfunction or damage of machinery and equipment may occur.
- 2. Removal of equipment, and supply/exhaust of compressed air**  
Before components are removed, first confirm that measures are in place to prevent workpieces from dropping, run-away equipment, etc. Then, cut off the supply air and electric power, and exhaust all air pressure from the system using the residual pressure release function.  
When the equipment is operated after remounting or replacement, first confirm that measures are in place to prevent the lurching of actuators, etc. Then, confirm that the equipment is operating normally.
- 3. Low-frequency operation**  
Valves should be operated at least once every 30 days to prevent malfunction. (Use caution regarding the air supply.)
- 4. Manual override**  
When a manual override is operated, connected equipment will be actuated.  
Operate only after safety is confirmed.

#### Caution

- 1. Drain flushing**  
Remove drainage from the air filters regularly.
- 2. Lubrication**  
Lubrication must be continued once it has been used in the system.  
Use class 1 turbine oil (with no additives), VG32. If other lubricant oil is used, it may cause a malfunction. Please contact SMC for information on the suggested class 2 turbine oil (with additives), VG32.



## VEX5 Series

# Specific Product precautions 1

Be sure to read this before handling.

### How to use DIN terminal connector

#### Disassembly

- 1) After loosening the thread (1), then if the housing (2) is pulled in the direction of the thread (1), the connector will be removed from the body of equipment (solenoid, etc.).
- 2) Pull the thread (1) out of the housing (2).
- 3) On the bottom part of the terminal block (3), there's a cut-off part (9). If a small flat head screwdriver is inserted between the opening in the bottom, terminal block (3) will be removed from the housing (2). (Fig. 1)
- 4) Remove the cable gland (4) and plain washer (5) and rubber seal (6).

#### Wiring

- 1) Passing through the cable (7), cable gland (4), plain washer (5), rubber seal (6) in this order, and then insert into the housing (2).
  - 2) From the terminal block (3), loosen the screw (11), then pass the lead wire (10) through, then again tighten the screw (11).
- Note 1) The tightening torque should be within 0.5Nm +/- 15%.
- Note 2) Cable (7) external:  $\phi 6$  to  $\phi 8$  mm.
- Note 3) Crimped terminal like round-shape or Y shape cannot be used.

#### Assembly

- 1) Passing cable gland (4), washer (5), rubber seal (6), housing (2) in this order through cable (7) and connect to terminal block (3) and then set the terminal block (3) to the housing (2).  
(Push it down until you hear the click sound.)
  - 2) Putting rubber seal (6), plain washer (5), in this order into the cable introducing slit on the housing (2), then further tighten the cable gland (4) securely.
  - 3) Insert the gasket (8) between the bottom part of terminal block (3) and a plug attached to equipment, and then screw (1) in from the top of the housing (2) to tighten it.
- Note 1) The tightening torque should be within 0.5Nm +/- 20%.
- Note 2) Connector orientation can be changed by 180 degrees depending on how to assemble the housing (2) and the terminal block (3).

#### DIN terminal connector

Description	Part no.
DIN connector	B1B09-2A6(standard)

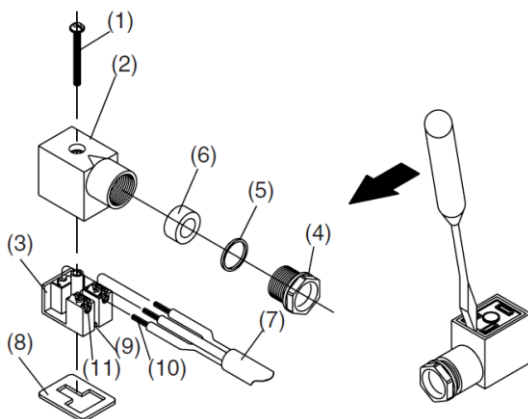

Fig. 1

### Light/Surge Voltage Suppressor

#### ⚠ Caution

##### AC

##### <Surge voltage suppressor>

Grommet (G,H)

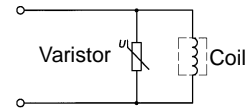

##### <Light/Surge voltage suppressor>

Grommet terminal (E), Conduit terminal (T)

DIN terminal (D)

When 100 VAC or more

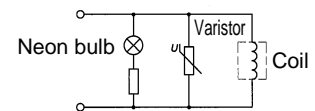

When 24 VAC or less

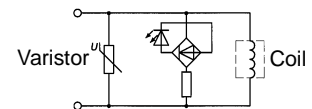

##### DC

##### <Surge voltage suppressor>

Grommet (G,H)

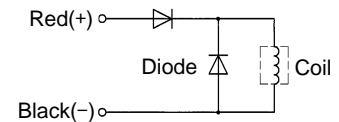

##### <Light/Surge voltage suppressor>

Grommet terminal (E), Conduit terminal (T)

DIN terminal (D)

When 100 VDC or more

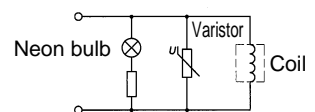

When 24 VDC or less

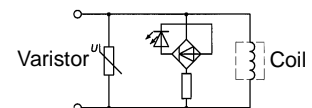





## VEX5 Series

# Specific Product precautions 2

Be sure to read this before handling.

### Electric wiring

#### ⚠ Caution

DIN terminal and terminal (with light/surge voltage suppressor) are connected inside as in the figure below. Connect to the corresponding power supply.

DIN terminal block

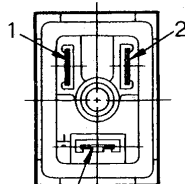

Ground

Terminal block

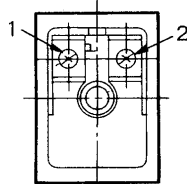

Terminal no.	1	2
DIN terminal	+	-
Terminal	+	-

- Applicable cable O.D.  
Type T:  $\phi 4.5$  to  $\phi 7$  mm  
Type E:  $\phi 2.3$  to  $\phi 2.8$  mm  
Type D:  $\phi 6$  to  $\phi 8$  mm
- Applicable crimp terminal  
Type E/T: 1.25-3, 1.25-3S

1.25Y-3N, 1.25Y-3S

(Round or "Y" shaped crimped terminals can not be used for type "D".)

#### Lead wire color (grommet)

Voltage	Color
100 VAC	Blue
200 VAC	Red
DC	Red (+), Black (-)

### How to use the needle

Rotate the needle clockwise to close, and counterclockwise to open.

Effective rotations of the needle		
VEX55**	VEX57**	VEX59**
6 turns	8 turns	

### How to use for the energy saving lifter

#### <System configuration and operation of circuit in which external pilot solenoid is used>

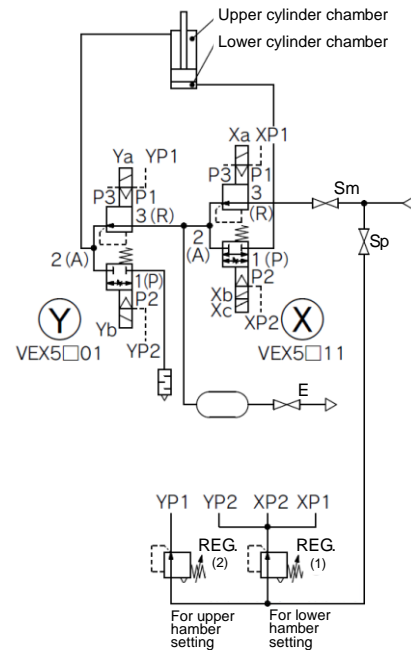

The two economy valves (hereinafter called VEX) (X) and (Y) and a tank composes a main system that drives the double acting cylinder, and the small regulator (hereinafter called REG) and pilot valve (hereinafter called SOL) remote control the economy valve.

#### Action (•ON, -OFF)

Cylinder	SOL	Xa	Xb	Xc	Yb	Ya	Mode
		Upward	High speed	•	•	-	
	Low speed	•	•	•	•	-	b
Downward	High speed	-	•	-	-	•	c
	Low speed	-	•	•	-	•	d
Stop		-	-	-	-	-	e

a: The air in the upper cylinder chamber is exhausted from the port 1 (P) of VEX (Y) and the air in the tank flows in through the port 1 (P) of VEX (X).

b: Air flows into the lower cylinder chamber through a throttled opening, set by a needle, from the port 2 (A) to 1 (P) of VEX (X).

c: The air in the tank flows into the upper cylinder chamber at a preset low pressure from the port 2 (A) of VEX (Y), while the air in the lower cylinder chamber returns to the tank through VEX (X).

d: Air returns to the tank through a throttled opening from the port 1 (P) to 2 (A) of VEX (X).

e: The air in the lower cylinder chamber is blocked at the port 1 (P) of VEX (X), while the air in the upper cylinder chamber is blocked at the port 2 (A) of VEX (Y).



## VEX5 Series

# Specific Product precautions 3

Be sure to read this before handling.

### How to use for the energy saving lifter

#### Adjustment

- 1) Open the inlet valve of the pilot system(Sp) and main system(Sm).
- 2) Set the lifting speed of the cylinder by REG(1). The pressure in the tank( $P_1$ ) which is set by VEX(⊗) and REG(1) consists of  $P_w$  (the balance pressure with the load weight) and  $P_u$  (the pressure which lift the cylinder).

$$P_1 = P_w + P_u > P_w$$

- To reduce the internal pressure of the tank, reduce the pressure with the discharge valve(E) of the tank before resetting with REG(1).

- 3) Cylinder upper chamber pressure( $P_2$ ) which is set by VEX(⊙) and REG(2) is the pressure which overcomes compressed pressure( $P_u + \Delta P$ ) in the lower chamber to the tank chamber at the lower end of the stroke.

$$P_2 > P_u + \Delta P$$

- 4) In order to release air from the device for maintenance, close the inlet valve for the main system (Sm) to release the air in the tank with exhaust valve (E), then discharge air in the cylinder upper chamber from VEX(⊙). Then discharge air from the pilot. This prevents lurching of the cylinder.

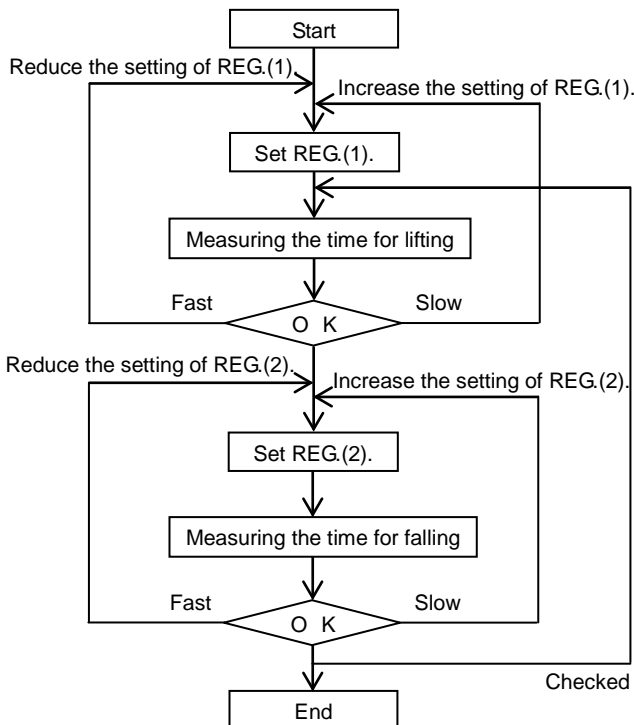

# Troubleshooting

Perform troubleshooting with higher possibility based on the failure phenomenon.

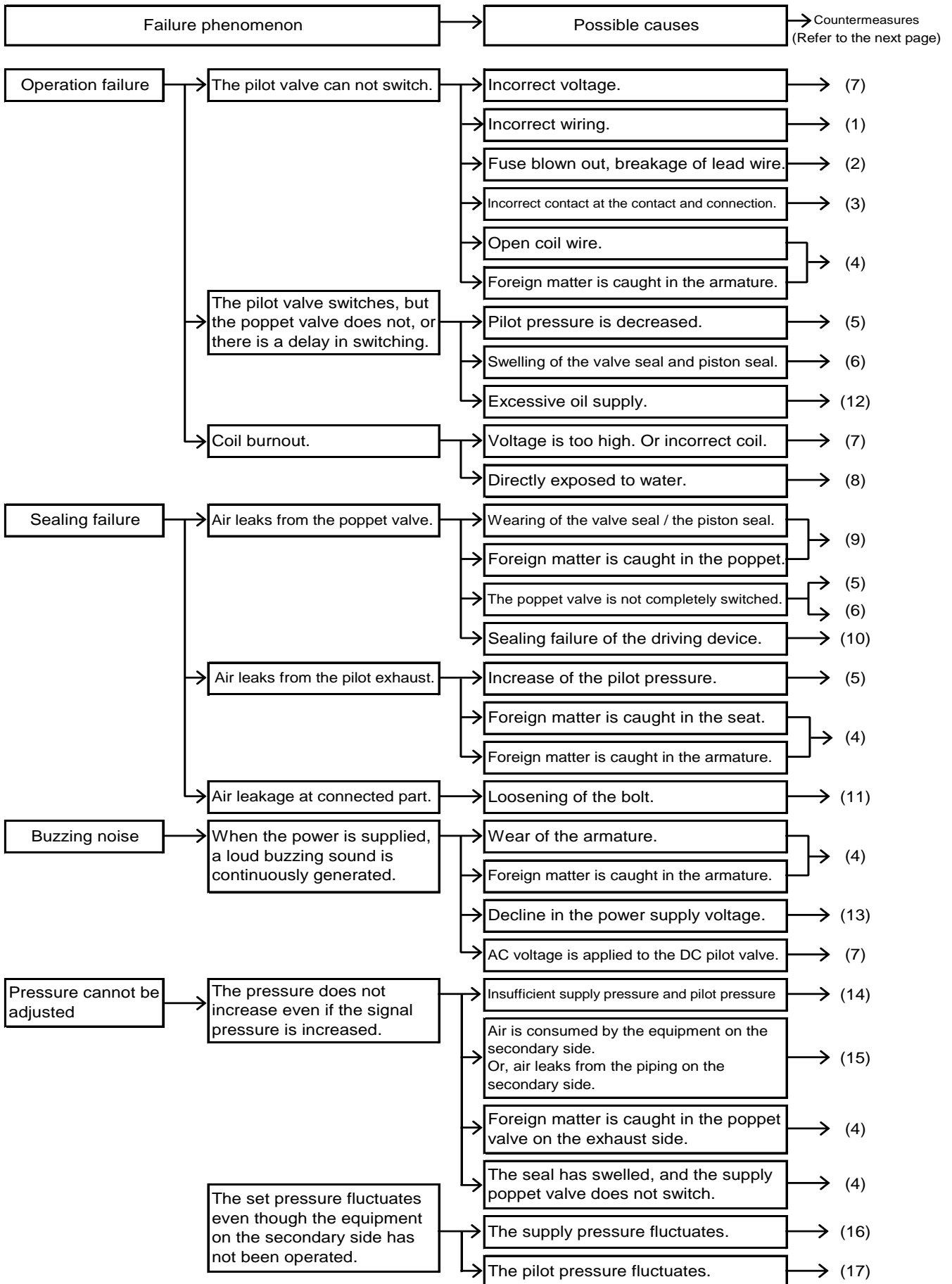

No.	Countermeasures
(1)	Connect wires correctly.
(2)	Replace the part.
(3)	Replace the part or connect wires correctly.
(4)	Replace the valve (the pilot valve) with a new one.
(5)	Adjust the pressure so that pilot pressure is within the specified range during operation.
(6)	<ul style="list-style-type: none"> <li>· If incorrect oil has been used for lubrication, remove the oil with air blow, and replace the valve with a new one. If a lubricant is used in the system after the replacement of the valve, use turbine oil Class 1 (with no additive) ISO VG32.</li> <li>· If there is a large amount of condensate or condensate cannot be removed completely, mount an auto drain or install a dryer and replace the valve.</li> </ul>
(7)	Check the voltage, and replace the pilot valve.
(8)	Protect the valve especially the coil to prevent it from being exposed to water.
(9)	If air leakage is caused by foreign matter, remove foreign matter in the piping by air blow and replace the valve.
(10)	Repair or replace the actuators.
(11)	Stop the air and additionally tighten the bolt. Check whether there is vibration or impact which has caused the loosening of the bolt. Install damping rubber so that the product is not affected by the vibration and impact.
(12)	Reduce the amount of lubrication to the amount at which the oil does not splash from the exhaust port (P port).
(13)	Adjust the voltage so that the voltage at the time of operation stays within the specification range.
(14)	Ensure proper supply pressure and pilot pressure.
(15)	Stop the air consumption. Check where the air is leaking from, and stop the air leakage.
(16)	Install a tank on the supply side to stabilize the supply pressure.
(17)	Install a tank on the pilot pressure supply side to stabilize the pilot pressure.

If the countermeasures above are not effective, there may be a problem with the valve. In that case, stop using the valve immediately.

If any of the examples below are applicable, there may be an internal problem in the valve. In that case, stop using the valve immediately.

- The voltage used was not the rated voltage.
- The oil supplied was not the specified type.
- Lubrication was stopped during operation. Or, lubrication was interrupted temporarily.
- The product was directly exposed to water.
- Strong impact was applied.
- Foreign matter such as condensate or dust has entered the product.
- Other than the cases mentioned above, any usage which falls under the precautions in this Operation Manual.

\*If the product malfunctions, please return the valve as it is.

Revision history		
A	Renewal	Ny
B	Safety Instructions	Po
C	Renewal	WU

1st printing : January 1987

## SMC Corporation

4-14-1, Sotokanda, Chiyoda-ku, Tokyo 101-0021 JAPAN

Tel: + 81 3 5207 8249 Fax: +81 3 5298 5362

URL <http://www.smcworld.com>

---

Note: Specifications are subject to change without prior notice and any obligation on the part of the manufacturer.

© 2018 SMC Corporation All Rights Reserved

No.VEX\*\*\*\*-OMA0019-C