



Operation Manual

PRODUCT NAME

Desktop Duster Box

MODEL/ Series/ Product Number

ZVB Series

Applicable model: ZVB40

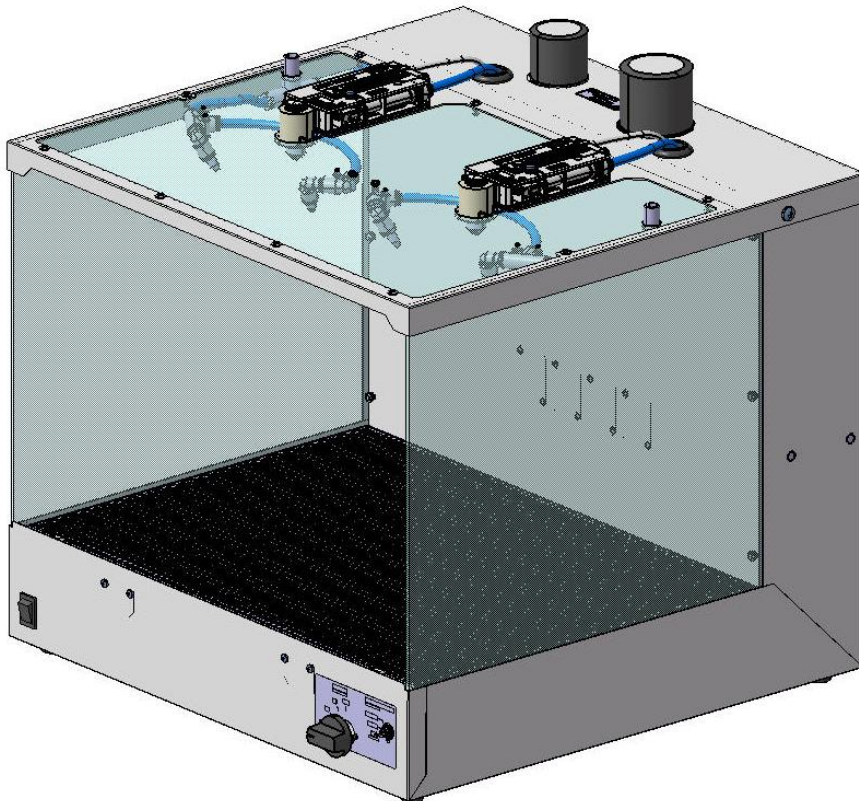

SMC Corporation

Safety Instructions	2
1. How to Operate	5
1.1 Outline	5
1.2 Installation and Piping.....	5
1.3 Wiring of the DC plug	6
1.4 Terminal Block	7
1.5 Operation Method	7
1.6 Operation step (with photoelectric sensor).....	8
1.7 Removal of side cover	9
2. Desktop Duster Box/ ZVB Series	10
2.1 Specifications.....	10
2.2 How to Order	10
2.3 Construction	11
2.4 Dimensions	12
2.5 Offset Voltage and Discharge Time	13
3. Ionizer Functions.....	14
3.1 Functions.....	14
4. Maintenance.....	15
4.1 Maintenance of Ionizer	15
4.2 Valve Maintenance	16



ZVB Series Safety Instructions

These safety instructions are intended to prevent hazardous situations and/or equipment damage. These instructions are categorized into three groups, "Caution", "Warning" and "Danger" depending on the level of hazard and damage, and the degree of emergency. They are all important notes for safety and must be followed in addition to International Standards (ISO/IEC), Japan Industrial Standards (JIS)¹⁾ and other safety regulations²⁾.

- *1) ISO 4414: Pneumatic fluid power – General rules relating to systems
ISO 4413: Hydraulic fluid power -- General rules relating to systems.
IEC 60204-1: Safety of machinery --Electrical equipment of machines. (Part1: General requirements)
ISO 10218-1992: Manipulating industrial robots -Safety.
JIS B 8370: General rules for pneumatic equipment.
JIS B 8361: General rules for hydraulic equipment.
JIS B 9960-1: Safety of machinery – Electrical equipment for machines. (Part 1: General requirements)
JIS B 8433-1993: Manipulating industrial robots - Safety, etc.

*2) Labor Safety and Sanitation Law, etc.



Caution

Caution indicates a hazard with a low level of risk, which if not avoided, could result in minor or moderate injury.



Warning

Warning indicates a hazard with a medium level of risk, which if not avoided, could result in death or serious injury.



Danger

Danger indicates a hazard with a high level of risk which, if not avoided, will result in death or serious injury.



Warning

1. The compatibility of the product is the responsibility of the person who designs the equipment or decides its specifications.

Since the product specified here is used under various operating conditions, its compatibility with specific equipment must be decided by the person who designs the equipment or decides its specifications based on necessary analysis and test results. The expected performance and safety assurance of the equipment will be the responsibility of the person who has determined its compatibility with the product. This person should also continuously review all specifications of the product referring to its latest catalog information, with a view to giving due consideration to any possibility of equipment failure when configuring the equipment.

2. Only personnel with appropriate training should operate machinery and equipment.

The product specified here may become unsafe if handled incorrectly.

An operator who is appropriately trained and experienced must perform the assembly, operation and maintenance of machines or equipment.

3. Do not service or attempt to remove product and machinery/equipment until safety is confirmed.

1. The inspection and maintenance of machinery/equipment should only be performed after all energy sources have been isolated and put into a safe mode.
2. Additionally, all driven objects should be contained in a safe manner. Follow all lock out procedures necessary for the machinery.the power from allsources is cut. Read and understand the specific product precautions of all relevant products carefully.
3. Before machinery/equipment is restarted, take measures to prevent unexpected operation and malfunction.

4. Contact SMC beforehand and take special consideration of safety measures if the product is to be used in any of the following conditions.

1. Conditions and environments outside of the given specifications, or use outdoors or in a location exposed to direct sunlight.
2. Installation on equipment in conjunction with atomic energy, railways, air navigation, space, shipping, vehicles, military, medical treatment, combustion and recreation, or equipment in contact with food and beverages, emergency stop circuits, clutch and brake circuits in press applications, safety equipment or other applications unsuitable for the standard specifications described in the product catalog.
3. An application which could have adverse effects on people, property, or animals especially those requiring special safety requirements.
4. If used in an interlock circuit, consider using a mechanical function as a redundant safety measure.. Perform periodical checks to confirm proper operation. Check the product regularly in order to confirm normal operation.



ZVB Series Safety Instructions

Caution

1. The product is provided for use in manufacturing industries.

The product herein described is basically provided for use in manufacturing industries.

If the product is being considered for use in other industries, consult SMC beforehand and exchange specifications or a contract if necessary.

If anything is unclear, contact your nearest sales branch.

Limited Warranty and Disclaimer/Compliance Requirements

The product used is subject to the following “Limited Warranty and Disclaimer” and “Compliance Requirements”.

Read and accept them before using the product.

Limited Warranty and Disclaimer

1. The warranty period of the product is 1 year in service or within 1.5 years after the product is delivered. *

Also, the product may have specified durability, running distance or replacement parts. Please consult your nearest sales branch.

2. For any failure or damage reported within the warranty period, which is clearly SMC’s responsibility, a replacement product or necessary parts will be provided.

This limited warranty applies only to the SMC product independently, and not to any other damage incurred due to the failure of the product.

3. Prior to using SMC products, please read and understand the warranty terms and disclaimers noted in the specified catalog for the particular products.

***: Vacuum pads are excluded from this 1 year warranty.**

A vacuum pad is a consumable part, so it is warranted for a year after it is delivered.

Also, even within the warranty period, the wear of a product due to the use of the vacuum pad or failure due to the deterioration of rubber material are not covered by the limited warranty.

Compliance Requirements

When the product is exported, compliancy to applicable laws must be followed as required by each individual country and its applicable agencies such as the Ministry of Economy, Foreign Exchange, and Foreign Trade Law.



ZVB Series Safety Instructions

Selection

Warning

1. Use within the specified voltage and temperature range.

Operation with a voltage other than that specified can cause malfunction, damage to the product, electric shock or fire.

2. Use clean compressed air as fluid.

Never use flammable or explosive gas as fluid. This may lead to fire or explosion. If fluid other than compressed air is used, consult SMC.

3. The product is not designed to be explosion proof.

Never use in an atmosphere of potential dust explosion, flammable gas or explosive gas. It may cause fire.

Caution

1. This product has not been cleaned. When using this product in a clean room environment, flush and confirm the product's purification level before use.

Handling

Caution

1. Do not drop, hit or apply excessive shock to the product.

Even if the body is not damaged, the internal components may be damaged, leading to a malfunction.

1. How to Operate

1.1 Outline

1. This is equipment used to remove dust that is stuck to a workpiece due to static and to remove static electricity and collect dust to prevent dust from sticking to the workpiece again.
2. Ionized air from IZN10E ionizer neutralizes static electricity and blows dust away from the workpiece.

1.2 Installation and Piping

1. This product must be installed on a stable horizontal surface.
2. Avoid using in a place where noise (electromagnetic wave and surge) is generated.
It may cause failure or damage to the product. Take measures to prevent noise at source and avoid power and signal lines from coming into close contact.
3. Do not allow foreign matter, workpiece or tool to enter the ionizer nozzle.
There is an emitter inside the nozzle. If the emitter gets in contact with metallic workpieces or tools, electrical shock may cause injury. If emitter is damaged, it may interfere with the specified function and performance, and may also cause operation failure and accident.
4. Mounting, wiring or adjustments should never be done without shutting off the power supply to the product.
5. Make sure to confirm the effect of static elimination after installation.
6. Power supply required to the product is 24 VDC and 1A.
When power is supplied to the product without using the exclusive AC adapter, make sure to use a stabilization power supply and connect wiring to the DC plug that is provided with the product as an accessory.
- Refer to P6 for wiring.
7. AC power supply cable of the exclusive AC adapter has a socket configuration that is for 100 VAC.
The AC adapter is applicable to 100 to 240V. Replace it with a socket that is applicable to other voltage if necessary. The socket needs to be prepared by the user.
8. D-class ground connection (ground with a resistance of less than 100Ω) MUST be used to the product.
Without grounding, the product will not provide the designed performance.
9. Operate in an environment in the specified ambient temperature and fluid temperature ranges (0 to 55°C).
Avoid sudden temperature changes even within specified temperature range, as it may cause condensation.
10. For air piping, use SMC tubing of diameter 10 mm or equivalent.
11. It is recommended to use supply air which purity class is 2:4:3 2:5:3 2:6:3 of ISO08573-1:2010 (JIS B8392-1:2012) or higher. The air containing mist or dust will cause the performance to decrease and shorten the maintenance cycle. Install a dryer (IDF series), air filter (AF/AFF series), and/or mist separator (AFM/AM series) to the upstream of the product to obtain clean compressed air.
12. Air connections should only be made with the pressure supply turned off.
Flush the system before piping to prevent foreign matter from entering inside the product.
13. Do not allow humans or objects to touch the ionizer while power is being supplied.
Otherwise, the offset voltage may change or the HV LED may turn ON.
14. Do not make a rapid pressure change while power is being supplied to the ionizer.
It will cause the NDL LED to turn ON.
15. Do not use this product in an enclosed space.
This product utilizes the corona discharge phenomenon. Although the amount is very small, Ozone and NOx are generated. Ozone condensation can increase if used in an enclosed space, which can affect the human body, so ventilation is necessary. Even when the room is ventilated, operating more than one product in a small space may increase the ozone density. Confirm that the ozone density in the operating environment is not more than the standard value of 0.1 ppm before starting operation.
16. When the dust collector is operating, air is discharged vigorously from the exhaust port.
Prevent exhausted air from contacting people or objects.
Piping (I.D. 32mm) or dust collecting bag must be connected to the exhaust port.
17. Read and understand the Operation Manual of this product before using. Confirm safety before starting operation.
18. If anything such as a part drops through to the bottom in the static elimination area, remove the mesh and take it away.

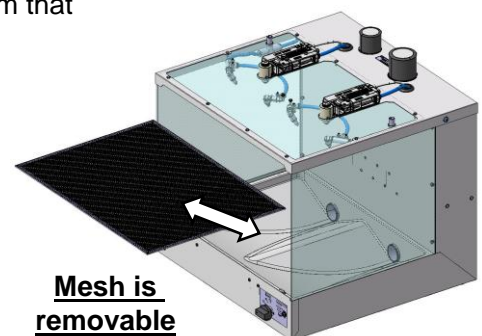

1.3 Wiring of the DC plug

If the AC adapter is not selected as an option, wire the attached DC plug with the procedure below.

(1) Remove the cover from the DC plug body.

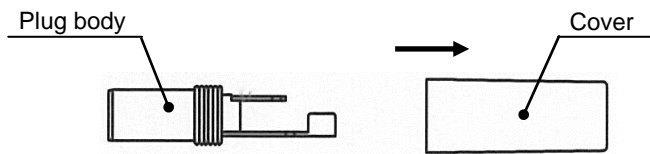

(2) Strip the end of the lead wires by 3 to 4 mm, and insert the lead wires into the cover, then wire them to the terminals. Mount a heat-shrinkable tube onto the lead wire on the terminal A side to prevent short-circuit.

-Terminal A (shorter side): Connect the 24 VDC wire.

-Terminal B (longer side): Connect the 0V wire.

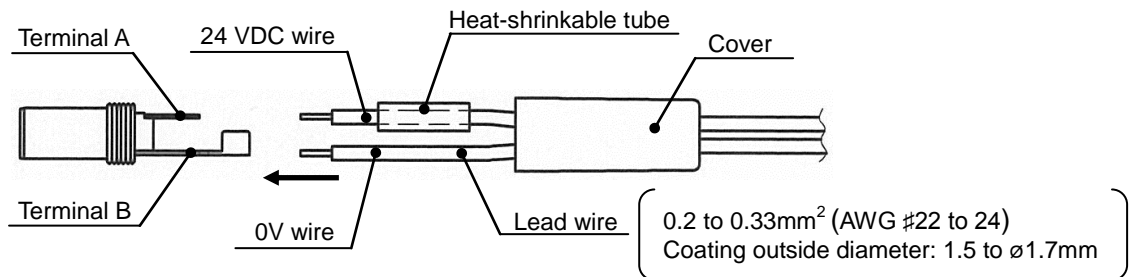

(3) Solder the wires and bend and clamp the crimping area of terminal B with pliers. Protect the terminal A side with a heat-shrinkable tube.

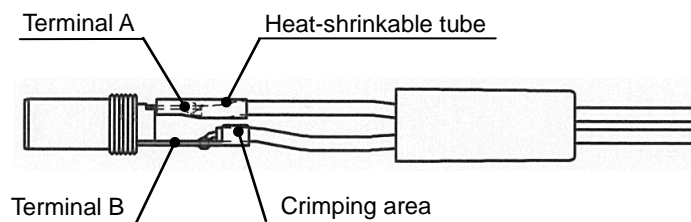

(4) Mount the cover onto the body and confirm that the lead wires are correctly connected.

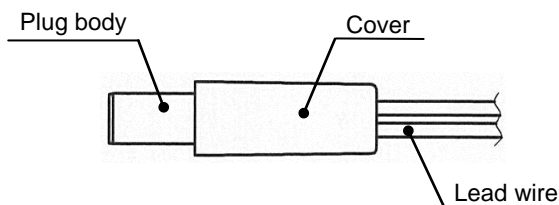

1.4 Terminal Block

No.	Terminal	Input/Output specifications	Remarks
1	Operation signal output	Transistor output: 0.1A, 5 to 24 VDC	Connect the cable (that is prepared by the user) to this terminal to output a signal while the desktop duster box is operating. ^{*1}
2	External input	+24 VDC	When an external signal is used for starting operation instead of a photoelectric sensor, connect an external switch to this terminal.
3	COM+		1: Connect the cable (that is prepared by the user) when the operation signal output is used.
4	COM-		2: Connect the cable (that is prepared by the user) when the external input is used.

*1: This output signal shows that the main circuit is ON. This does NOT show the operation status of the ionizer.

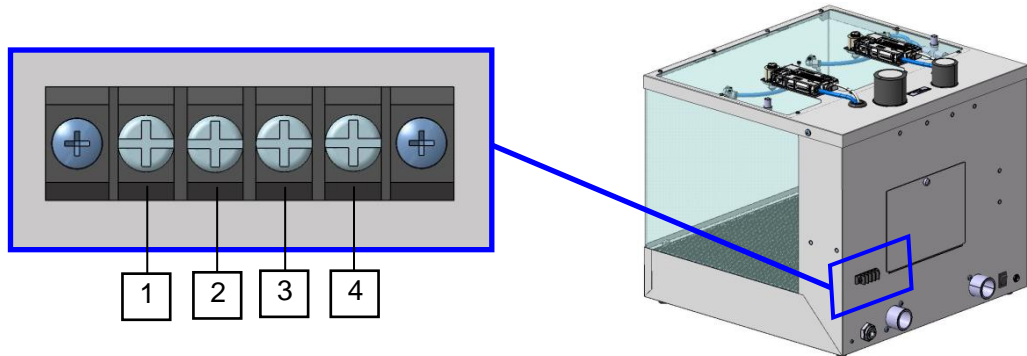

1.5 Operation Method

Refer to "2.3 Construction" for descriptions of each part.

- Turn ON the main power supply switch and the dust collector switch after confirming safety guidelines are met.
Make sure the exhaust port is directed away from objects or operators. The dust collector discharges adsorbed substances from the exhaust port at a high speed.
- Supply pressure of 0.4 to 0.8 MPa (recommended values) to the piping that is connected (by opening the valve or regulator prepared by user). Adjust the pressure of the regulator connected to the air flow adjustment to be within the range of 0.1 to 0.3MPa Adjust the pressure of the regulator connected to the the dust collector to be within the range of 0.3 to 0.5 MPa.
- Set the operation time of the desktop duster box using the Operation time set switch. The operation time can be selected from continuous, 2 second, 5 seconds, or 10 seconds.

Operation time set switch

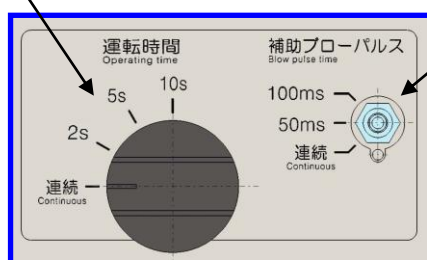

Additional air flow pulse operation time set switch

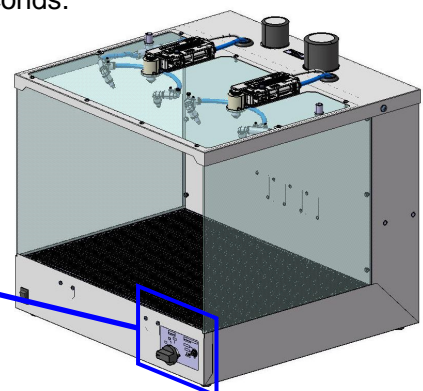

- Set the additional air flow pulse operation time with the Additional air flow pulse operation time set switch. The operation time can be selected from continuous (no pulse), 50ms, or 100ms.
- Check the actual static and dust eliminating condition of the workpiece.
When the additional air flow is too strong, adjust the pressure or air flow rate by rotating the handle of the regulator connected to the air flow adjustment or the additional air flow adjusting restrictor (option).
- When not using the dust collector, turn the switch off.

1.6 Operation step (with Photoelectric Sensor)

1. Put a part into the ZVB Desktop Duster Box

Operates with a photoelectric sensor

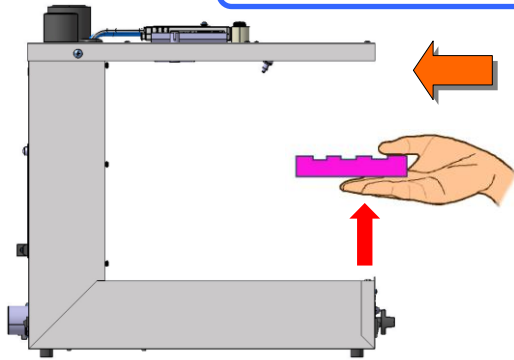

2. Starts collecting dust

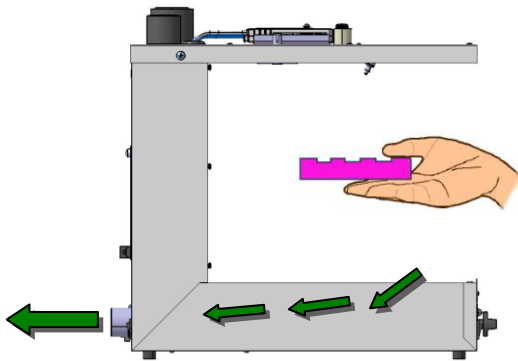

Dust collector starts operating.

0.5sec

3. Starts static neutralization and dust removal

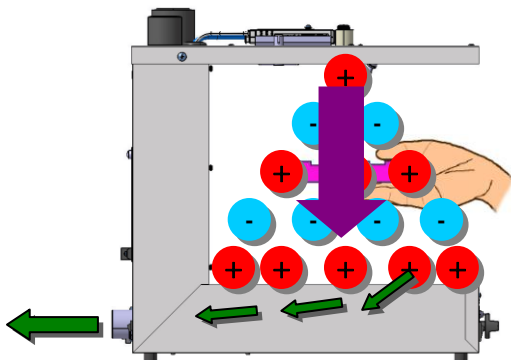

Setting time: Continuous, 2 seconds, 5 seconds and 10 seconds
Additional air flow and the ionizer operate for the set operating time

4. Stops static elimination neutralization and dust removal

Additional air flow and operation of the ionizer stop after the set operating time

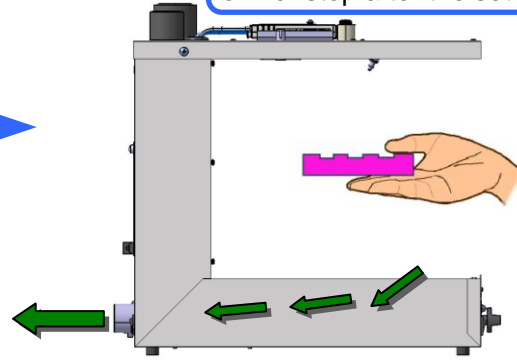

0.5sec

5. Stops collecting dust

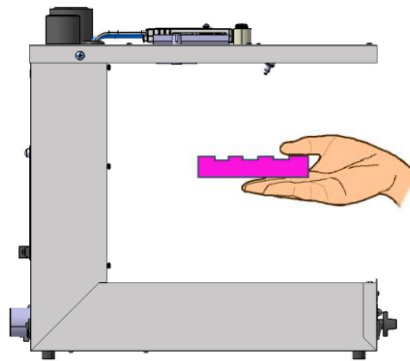

Dust collector stops.

6. Remove part from ZVB Desktop Duster Box(*)

Electricity and dust removal completed.

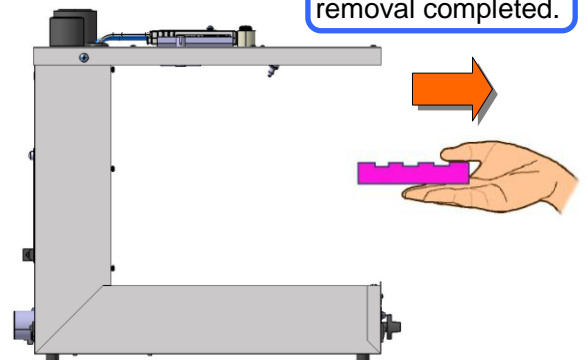

(*) When operating with Timer, the sensor function stops for 0.5 seconds to prevent incorrect operation during removal of workpieces.

1.7 Removal of side cover

Both sides or one side of the side covers can be removed from the desktop duster box. By removing the side cover(s), it is possible to mount the desktop duster box on the conveyor line and place workpieces from the side of the body. However, the amount of dust scattered outside will be larger than usual due to an increase in the opening area.

(1) Remove the holding screws (2pcs.) on the side of the desktop duster box.

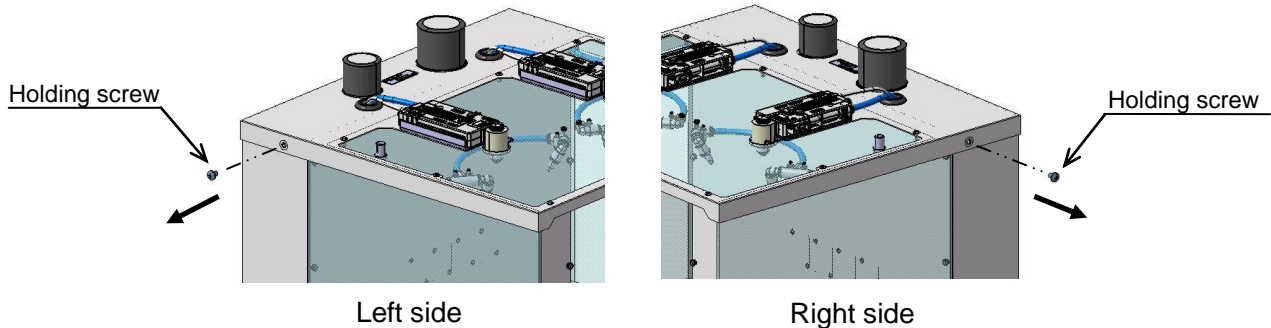

(2) Slide the side covers while lifting the top cover assembly as shown in the figure below. The piping and wiring of the top cover assembly and body are connected, so do not lift the top cover more than required.

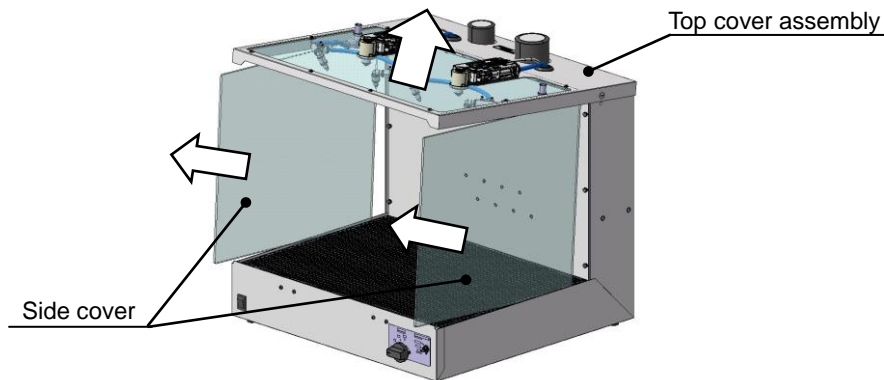

(3) Return the top cover assembly to the original position while placing the position of the tube to the slot in the body. Tighten the holding screws with a 1.50 ± 0.15 Nm of the tightening torque while holding the top cover assembly horizontal.

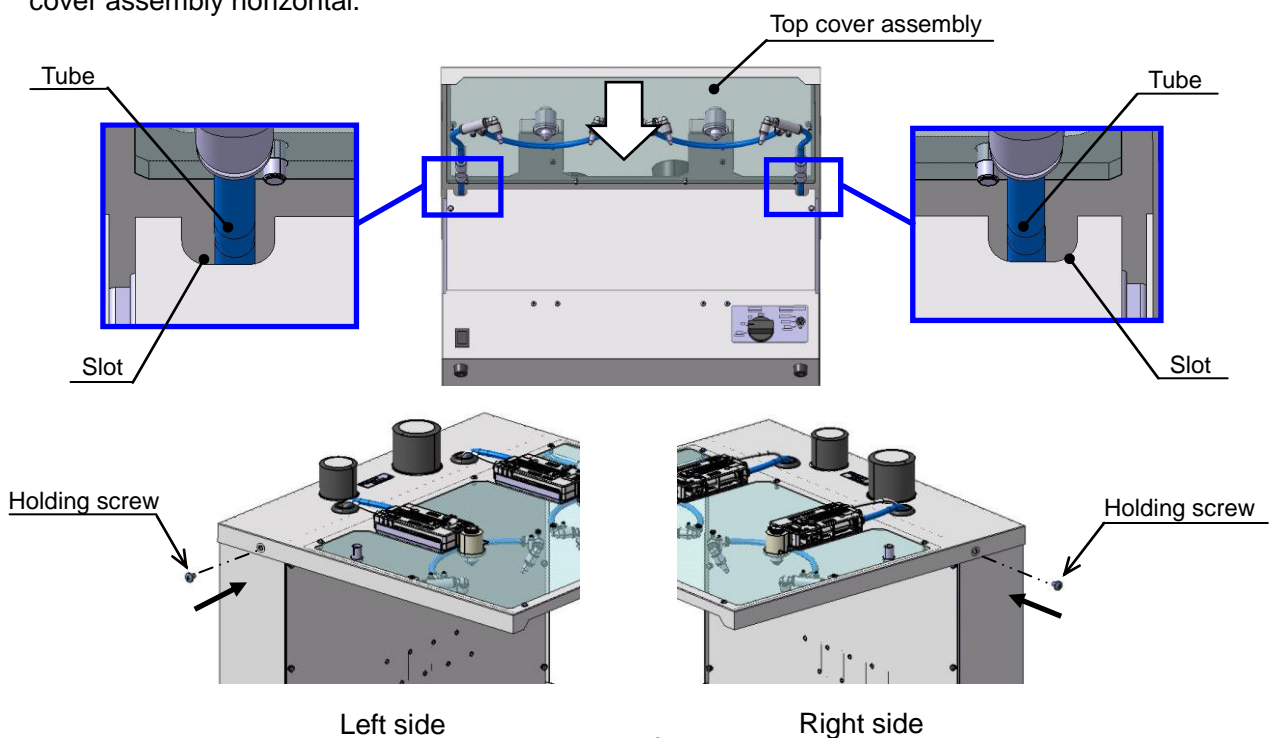

2. Desktop Duster Box/ ZVB Series

2.1 Specifications

Ionizer	Ion generating type	Corona discharging type
	Voltage supply type	High frequency AC type
	Discharge output ^{*1}	2500V
	Amount of ozone generated ^{*2}	0.03ppm
	Offset Voltage ^{*3}	Within +/-10V
	Discharge time ^{*3}	0.3 seconds (1000V → 100V)
Dust collection	Supply pressure range	0.1 to 0.7MPa
	Exhaust flow rate ^{*4}	410 to 1, 580 l/min (ANR)
Body	Fluid	Clean Dry Air
	Operating pressure range	0.2 to 0.8MPa
	Tube O.D.	Ø10
	Power	24 VDC +/-10% 1A
	Operating time setting	Continuous/timer [2, 5, 10sec]
	Additional air flow setting	Continuous blow/pulse blow [50/100ms intervals]
	Ambient/Fluid temperature	0 to 55°C
	Ambient humidity	35 to 65 %RH (No condensation)
	Air consumption ^{*5}	800 l/min (ANR)
Body weight	9.9kg ^{*6}	

*1: Value obtained by measurement using 1,000 MΩ and a probe of 5pF.

*2: Value above background level, measured with a distance of 300mm from the front of the ionizer nozzle.

*3: Static elimination characteristics is data obtained from the test using a charge plate (150mm x 150mm, static capacity 20pF) placed at a distance of 100mm from the ionizer nozzle according to ANSI standard in US. This is provided as a guide with regulator 2 pressure at 0.2MPa and without operating the dust collector. The values are provided just as a guide as they will vary depending on the material and size of the workpiece.

*4: Value for one dust collector (supply pressure: 0.1 to 0.5 MPa)

*5: When additional air flow pressure is set to 0.2MPa and supply pressure to the dust collector to 0.4MPa.

*6: AC adaptor and options (exhaust duct hose, dust collecting bag) are not included.

2.2 How to Order

ZVB 40 — B S A — □

1
2
3
4
5

1. Size

40

2. Additional air blow

B	With an auxiliary blow
---	------------------------

3. Photoelectric sensor

NIL	Without photoelectric sensor ^{*1}
S	Photoelectric sensor ^{*2}

*1: Connect a switch to the external input terminal on the back side of the product.

*2: This is a regression reflection type photoelectric sensor. Completely transparent workpieces detection is not available.

*3: The AC power supply cable attached to the product has the configuration applicable to socket of 100 VAC. The cap needs to be changed when the cable is connected to a socket of voltage other than 100 VAC.

4. AC adapter

NIL	Without AC Adaptor (DC-plug in attached)
A	AC Adaptor ^{*3}

5. Option

NIL	Without option
D	With 2 three meter length exhaust duct hoses with 2 hose bands attached
P	With 2 dust bags with 2 hose bands attached
S	With flow restrictors for additional air flow at two positions



DC plug

AC adapter
(Single product No.: ZVB-AC1)

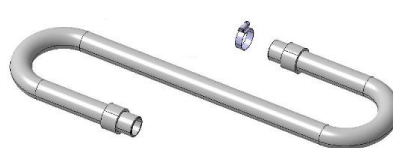

3 m exhaust duct hose
(Single product No.: ZVB-D3A)

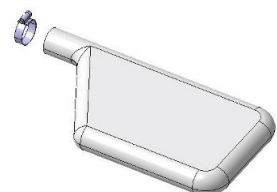

Dust collecting bag
(Single product No.: ZVB-P1A)

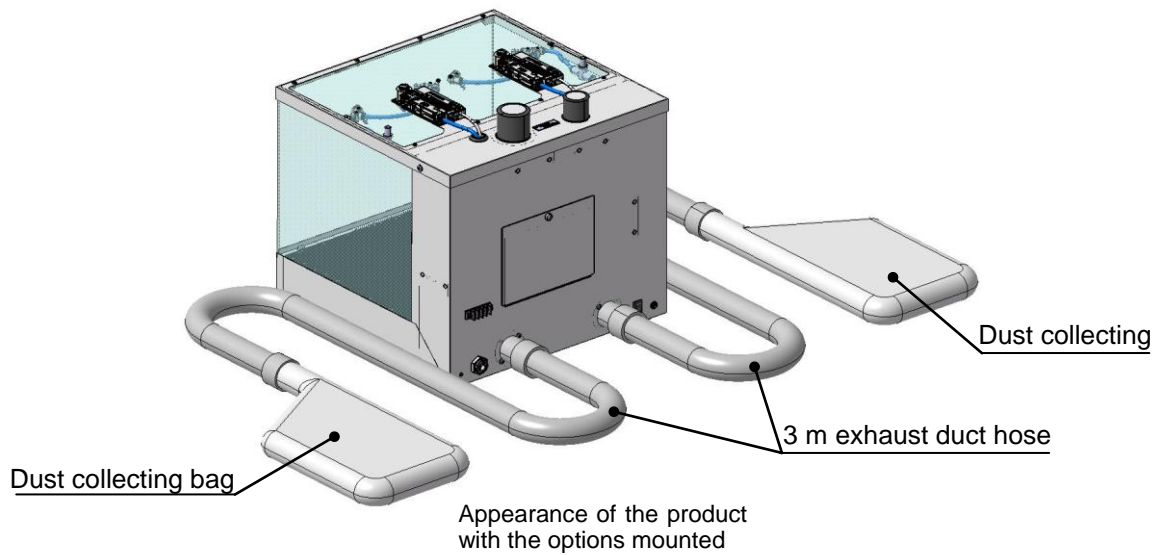

2.3 Construction

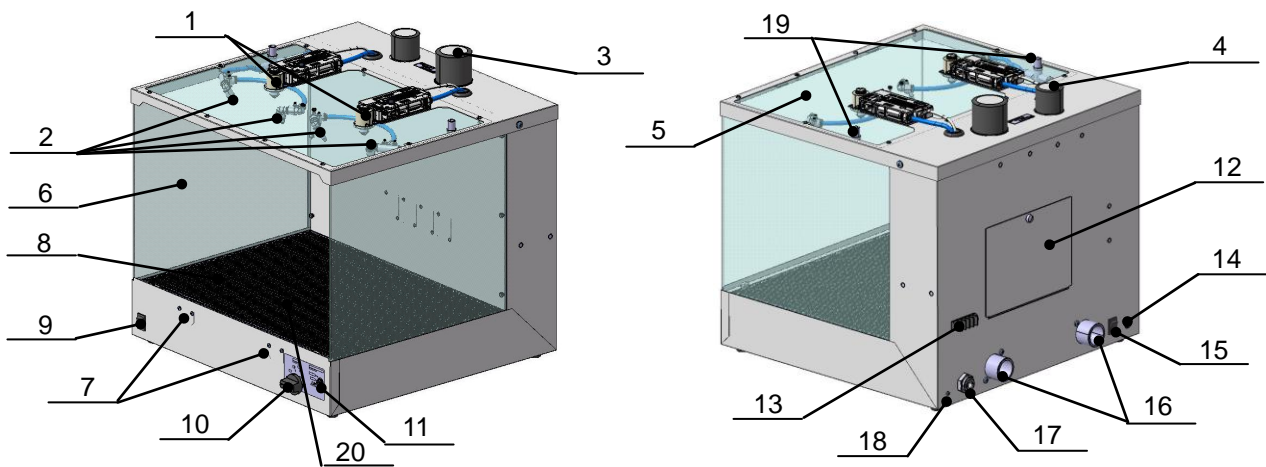

Component parts

No.	Description	Remarks
1	Ionizer	With diffusion nozzle
2	Additional air flow nozzle	Nozzle diameter $\varnothing 1.0$
3	Regulator for adjusting supply pressure to the dust collector	With pressure gauge
4	Regulator for adjusting supply pressure for additional air flow	With pressure gauge
5	Top cover assembly	Static electricity restriction grade (PET)
6	Side cover	Static electricity restriction grade (PET)
7	Photoelectric sensor	
8	Mesh	Detachable
9	Power supply switch	
10	Operation time set switch	Operating time can be set

No.	Description	Remarks
11	Additional air flow pulse operation time set switch	Pulse selection
12	Cover for valve maintenance	
13	Terminal block	
14	AC adapter (DC plug) entry	
15	ON/OFF switch for dust collector	
16	Exhaust port of the dust collector	
17	Compressed air supply port	$\varnothing 10$
18	Grounding screw	
19	Restrictor (optional)	With flow adjusting restrictor for use with additional air flow option
20	Suction slope (For ZVB40)	

Replacement parts

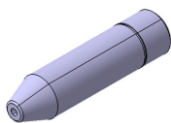

Additional air blow nozzle
(Model: ZVB-N10A)



Suction slope (For ZVB40)
(Model: ZVB-V40A)

2.4 Dimensions

- Desktop duster box body (product No.:ZVB40-B**-*)

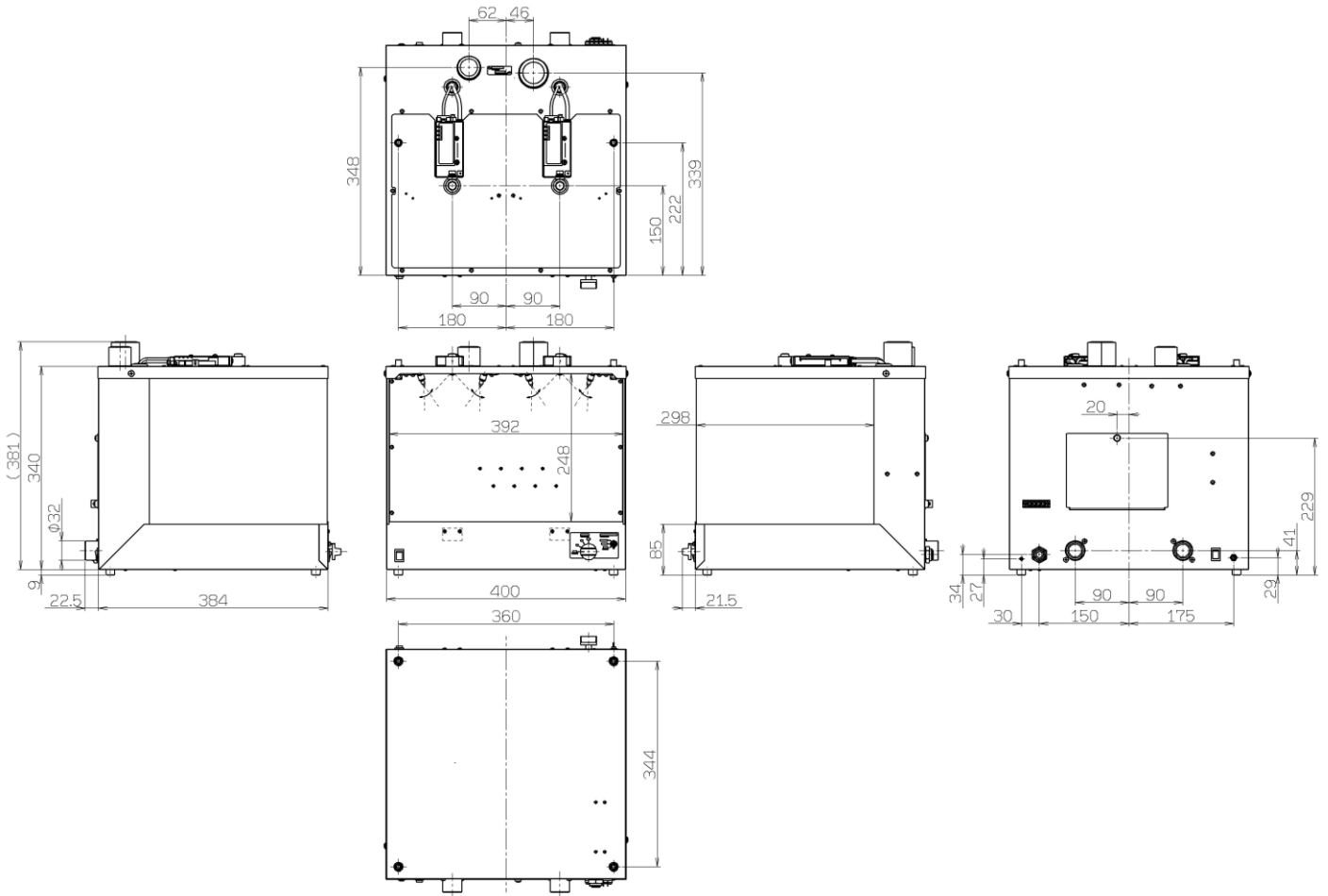

- Exhaust dust hoses set (part No.: ZVB-D3A)

(*) Connection inside diameter: $\varnothing 32\text{mm}$, outside diameter: $\varnothing 36\text{mm}$

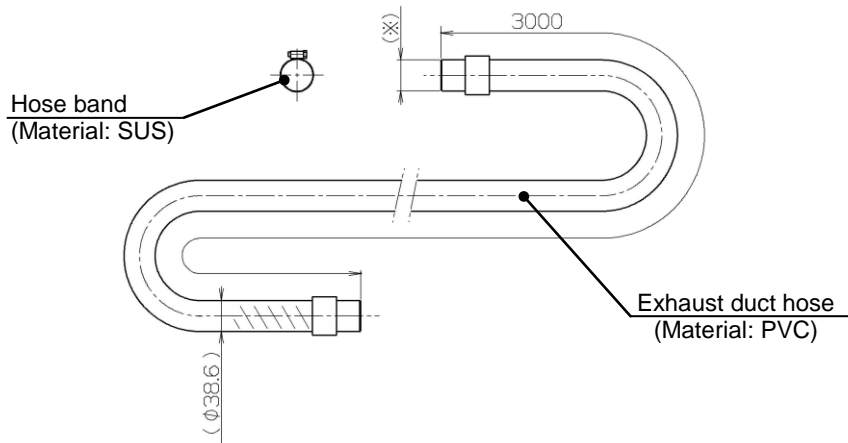

- Duct collector bag set (Part No.: ZVB-P1A)

(*) Connection inside diameter

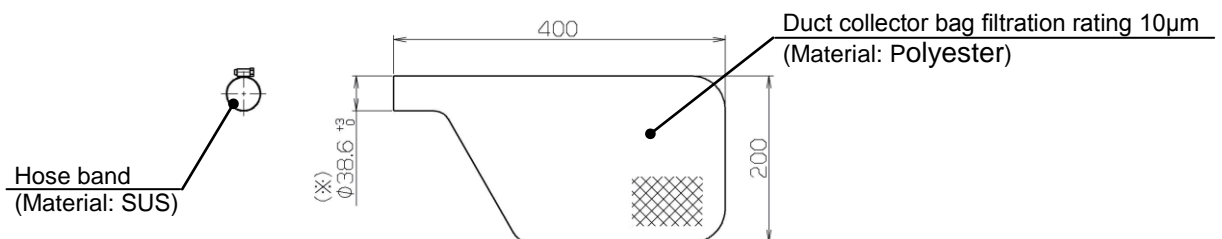

2.5 Offset Voltage and Discharge Time

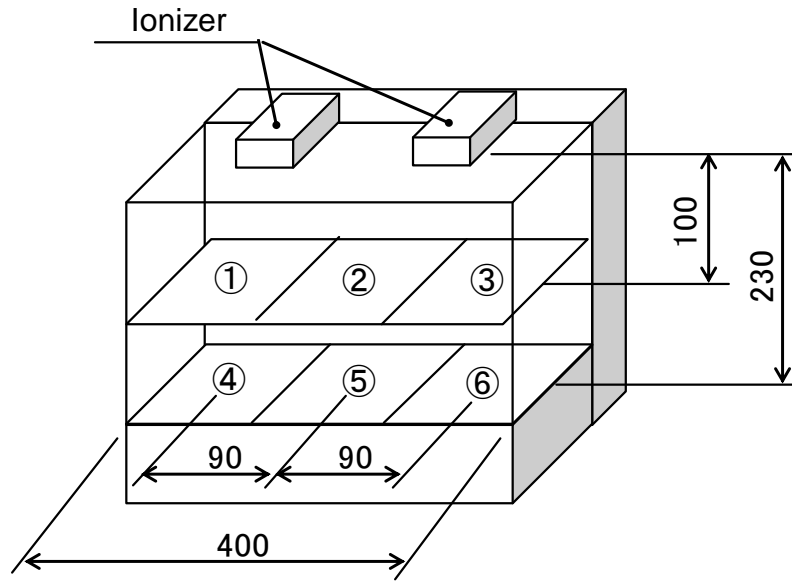

Actual measurement values of the static elimination performance at the points 1 to 6 are shown below. (See Notes shown below)

- Continuous operation of the additional air flow

Point for measurement	Offset voltage (V)	Discharge time (s)
(1)	1.9	0.20
(2)	1.3	0.22
(3)	0.6	0.21
(4)	1.9	0.35
(5)	1.9	0.41
(6)	3.1	0.40

- Pulse operation of the additional air flow(50ms)

Point for measurement	Offset voltage(V)	Discharge time (s)
(1)	0.6	0.20
(2)	2.5	0.20
(3)	1.3	0.20
(4)	1.3	0.36
(5)	1.9	0.37
(6)	3.1	0.39

- Pulse operation of the additional air flow (100 ms)

Point for measurement	Offset voltage (V)	Discharge time (s)
(1)	0.0	0.19
(2)	0.6	0.19
(3)	1.3	0.19
(4)	0.6	0.37
(5)	1.3	0.39
(6)	2.5	0.37

- Without operation of the additional air flow

Point for measurement	Offset voltage(V)	Discharge time (s)
(1)	-0.6	0.18
(2)	0.0	0.18
(3)	0.0	0.18
(4)	0.0	0.40
(5)	0.6	0.50
(6)	1.3	0.45

Notes:

- When additional air flow pressure is set to 0.2MPa and supply pressure to the dust collector to 0.4MPa.
- Discharge time is the time required to reduce electricity on the static plate (150 mm x 150 mm, static capacity 20 pF) from 1000 V to 100 V.
- The above shown values are measured using SMC's measurement instruments and conditions, and not the guaranteed values.

3. Ionizer Functions

3.1 Functions

1. Name and description of indication LEDs

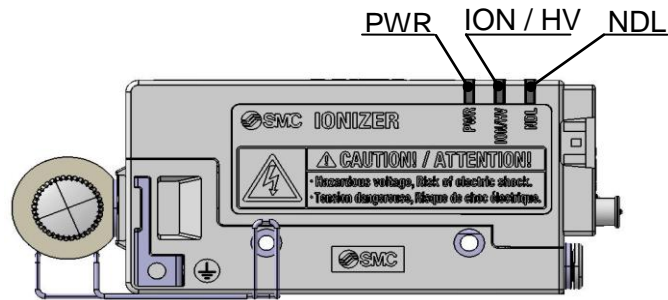

Symbol	Color	Description	Contents
PWR	Green	Power supply indicator	LED is ON when the power supply is ON; LED flashes when the power supply or CPU is abnormal.
ION / HV	Green/Red	Ion discharge / Incorrect high voltage LED	Green LED is ON: discharge in progress Red LED is ON: high voltage error Red LED flashing: CPU error
NDL	Green	Emitter maintenance indicator	LED is ON: ion generation decreased LED flashing: CPU error

2. Alarm

Alarm name	Contents	How to release error
Power supply failure	When power supply which is connected to the product is not within the range of 24 V +/-10%, the abnormal signal will be turned OFF (ON when it is normal) and discharge signal will be turned OFF, and the PWR LED (green) will flash to indicate the error. When the failure occurs, ion generation will be stopped.	To resolve the error, reset the product automatically by connecting a power supply which provides a power supply voltage of 24 V +/-10%.
Incorrect high voltage	When incorrect electric discharge is generated during operation, the abnormal signal will be turned OFF (ON when it is normal) and discharge signal will be turned OFF, and the ION/HV LED (red) will light up to indicate the error. When the failure occurs, ion generation will be stopped.	The incorrect electric discharge could be caused by condensation or dust on the emitters. To resolve the error, input the reset signal or supply power again after remedying the cause of the incorrect electric discharge.
CPU ALM	When CPU makes an abnormal operation due to noise or other reasons, the abnormal signal will be turned OFF (ON when it is normal), and the PWR (green), ION-HV (red) and NDL (green) LED will flash to indicate the error. When the failure occurs, ion generation will be stopped.	To prevent noise, perform the following actions and take countermeasures. 1. Keep the product away from sources of noise. 2. Route the power line and cable of the product separately. 3. Install a noise filter to the power supply of the product. To resolve the error, supply power again after fixing the cause of the error.
Maintenance warning	The maintenance signal is ON when static electricity neutralization performance has decreased due to contamination, wear or damage to the emitters. The NDL LED (green) will turn ON to indicate that cleaning or replacement of the emitters needs to be performed. The product continues operation even when the maintenance warning has been generated.	When emitters are contaminated, the error can be solved by cleaning them. However, when they are worn out or damaged, it is necessary to replace the emitter assembly. To resolve the error, input the discharge stop signal or supply power again after remedying the cause of the error.

4. Maintenance

1. Perform maintenance regularly and clean the emitters. (every 2 weeks suggested.).

The maintenance must be performed by an operator who has sufficient knowledge and experience.

If the ionizer is used for a long time and there is dust on the electrodes, performance of the product will be reduced. When the NDL LED (maintenance signal LED) is ON, the emitter will need to be cleaned. If the emitter gets worn and static electricity elimination ability does not recover even after cleaning, replace the emitter.

2. Before starting inspection, cleaning or replacing the emitter, or replacing the valves, be sure to turn OFF the power and air supply to the main body.

If the emitter is touched while the product is energized, this may cause an electric shock or accident.

3. Do not disassemble or modify the product.

This may lead to accidents such as electric shock, failure, fire or etc. If the product is disassembled and/or modified, the functions and performance in the specifications may not be achieved and the product will not be guaranteed.

4. Do not operate the product with wet hands.

This may cause an electric shock or accident.



High voltage caution

A high voltage generating circuit is mounted onto this product. Verify that the power supply is OFF when performing maintenance. Never disassemble or modify the product, as this can cause loss of product functionality, and there is also a risk of electric shock and earth leakage.

4.1 Maintenance of Ionizer

4.1.1 Emitter cleaning

1. Rotate the handle of the emitter assembly by hand and remove it.
2. Ionizer emitter cleaning kit: The emitter is cleaned with IZS30-M2.
3. Insert the emitter assembly back to the port using caution not to damage the end of the emitter, and screw it in. ^{Note)}

4.1.2 Replacement of Emitter

1. Rotate the handle of the emitter assembly by hand and remove it.
2. Replace it with a new emitter assembly.
3. Insert the emitter assembly back to the port using caution not to damage the end of the emitter, and screw it in. ^{Note)}

Notes:

- Screw in the emitter assembly completely until the handle of the emitter assembly gets into close contact with the mounting surface of the body.
- If the ionizer nozzle touches the inner surface of the hole on the desktop duster box body after mounting the electrode assembly, adjust the angle of the ionizer nozzle not to touch it.
- Use caution not to get injured with the end of the emitter.

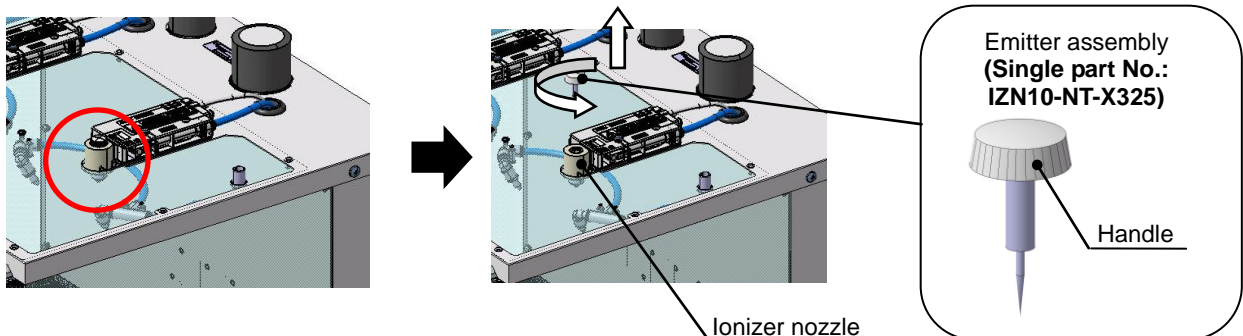

4.2 Valve Maintenance

1. Rotate the decorative bolt which holds the valve maintenance cover in the counter-clockwise direction by hand to remove the cover.

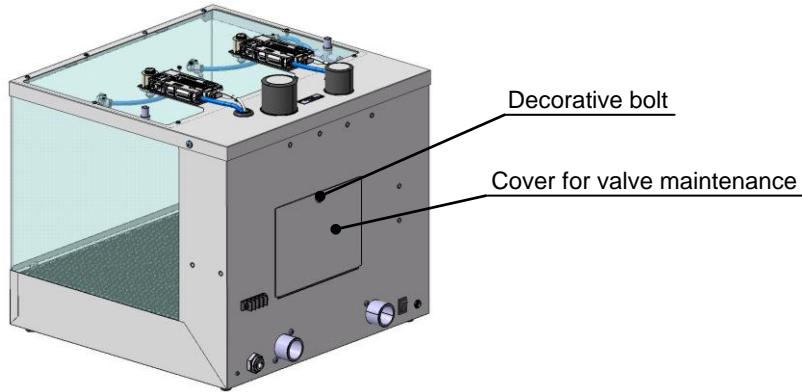

2. Layout of the valves and the piping are shown below.

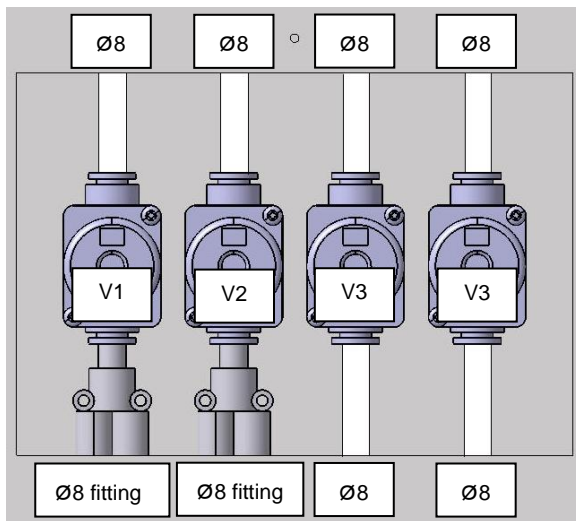

Product number for single unit of the valve

V1: VXJ1120-C8-5MO-X3 (for ionizer)

V2: VXJ1120-C8-5MO-X3 (for additional air flow)

V3: VXJ1120-C8-5MO-X3 (for dust collection, 2pcs.)

3. Remove the cap nut that holds the valve to be replaced. (Recommend using an M3 Phillips head screwdriver with magnet.)

Disconnect the piping on top and bottom of the valves and remove the connector for wiring. Replace the valves with new ones. ^{Note)}

Notes:

- Mounting orientation of the valves is specified. Make sure that the connector for wiring should be on the upper side of the valve.
- Use a magnet driver for the replacement so that the cap nut does not fall into the product.

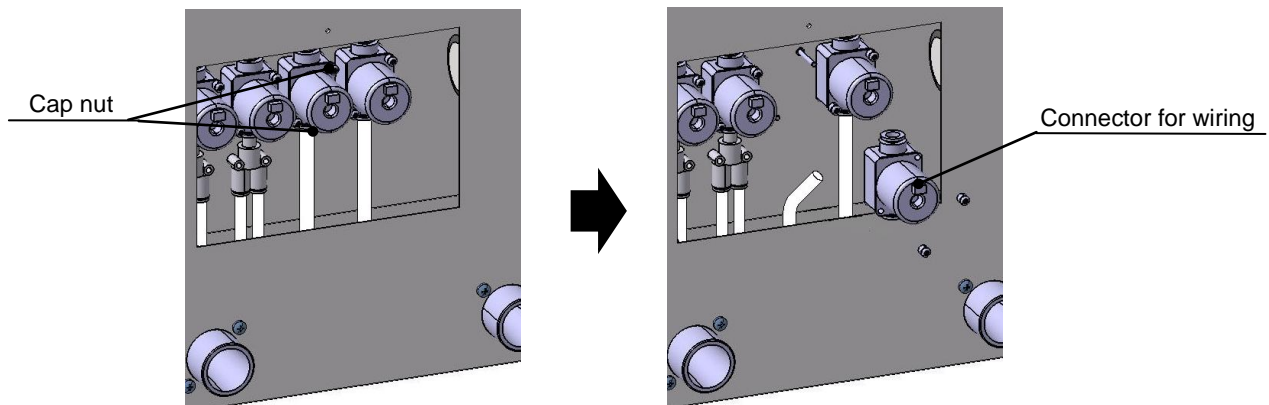

4. Reassemble the parts such as valve and cover in the reverse order of the removal "1" to "3".

Revision history

Edition B Ionizer changed. Replacement parts added.

SMC Corporation

4-14-1, Sotokanda, Chiyoda-ku, Tokyo 101-0021 JAPAN

Tel: + 81 3 5207 8249 Fax: +81 3 5298 5362

URL <https://www.smcworld.com>

Note: Specifications are subject to change without prior notice and any obligation on the part of the manufacturer.

© 2014 SMC Corporation All Rights Reserved