

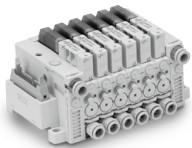

Vacuum Ejector Variations

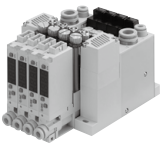

		ZK2				ZQ		
Series								
Features		Digital pressure switch with an energy saving function is mounted. Suction flow is increased by the two-stage ejector. Both the single unit and manifold are applicable to reduced-wiring. Valve with a self-holding function ensures power saving. Can also accommodate a pump system.				Compact type vacuum ejector with a width of 10 mm and a weight of 109 g. Has vacuum pressure switch LED display.		
Vacuum pump system		●				●		
Nozzle diameter [mm]		0.7	1.0	1.2	1.5	0.5	0.7	1.0
Max. suction flow [L/min(ANR)]		29	44	61	67	5	10	22
Air consumption [L/min(ANR)]		24	40	58	90	14	23	46
Guidelines for applicable pad diameter [mm]*	2	●	●	●	●	●	●	●
	4	●	●	●	●	●	●	●
	6	●	●	●	●	●	●	●
	8	●	●	●	●	●	●	●
	10	●	●	●	●	●	●	●
	13	●	●	●	●	●	●	●
	16	●	●	●	●	●	●	●
	20	●	●	●	●	●	●	●
	25	●	●	●	●	●	●	●
	32	●	●	●	●	●	●	●
	40	●	●	●	●	●	●	●
	50		●	●	●			
	63			●	●			
	80			●	●			
	100			●	●			
125			●	●				
150				●				
200								
250								
With valve		●				●		
With filter		●				●		
With silencer		●				●		
With manifold		●				●		
Vacuum pressure switch	Switch output	●				●		
	Digital display	●				●		
	Analog output	● (Pressure sensor)				●		
Single unit, Width dimension [mm]		15				10		
Single unit, Weight [g]		81				109		

* It is assumed as a basis that one pad is used for one ejector. The sizes given should only be regarded as guidelines. The optimal pad size may differ depending on factors such as piping conditions, desired ducts, etc. Be sure to confirm the selection method described in the catalog and make a selection accordingly.

Vacuum Ejector Variations

Series		ZH							ZU	
		 P.221							 P.261	
Features		Can be connected with the combination of a one-touch and a screw-in connection.							Vacuum port and supply port are located collinearly to facilitate piping.	
Vacuum pump system										
Nozzle diameter [mm]		0.5	0.7	1.0	1.3	1.5	1.8	2.0	0.5	0.7
Max. suction flow [L/min(ANR)]		6	12	26	40	58	76	90	7	12
Air consumption [L/min(ANR)]		13	27	52	84	113	162	196	14	29
Guidelines for applicable pad diameter [mm]*	2	●	●	●	●	●	●	●	●	●
	4	●	●	●	●	●	●	●	●	●
	6	●	●	●	●	●	●	●	●	●
	8	●	●	●	●	●	●	●	●	●
	10	●	●	●	●	●	●	●	●	●
	13	●	●	●	●	●	●	●	●	●
	16		●	●	●	●	●	●		●
	20		●	●	●	●	●	●		●
	25			●	●	●	●	●		
	32			●	●	●	●	●		
	40				●	●	●	●		
	50				●	●	●	●		
	63					●	●	●		
	80					●	●	●		
	100					●	●	●		
125						●	●			
150							●			
200										
250										
With valve										
With filter										
With silencer		●								
With manifold										
Vacuum pressure switch	Switch output									
	Digital display									
	Analog output									
Single unit, Width dimension [mm]		14 to 22							12.8	
Single unit, Weight [g]		5 to 23.3							7	

Air Suction Filter Variations

Series		ZFA		ZFB				ZFC				
		 P.276		 P.279				 P.281				
Features		Pleated element provides a large filter area. Adaptable for a manifold application		Unrestricted 360° piping tube mounting With One-touch fitting				IN/OUT straight piping With One-touch fitting				
Port size	Screw-in	1/8	1/4	—	—	—	—	—	—	—	—	—
	Applicable tubing O.D. for One-touch fittings (Metric)	—	—	4	6	8	10	4	6	8	10	12
Air flow [L/min(ANR)]		50	200	10	30	50	75	10	20 30	70	80	100
Filtration [μm]		30		30				5				



Vacuum Filter
AFJ Series

➤ P.779



























Suction Filter
ZFC050

➤ P.272

Vacuum Pad Variations ZP3/ZP3E/ZP2/ZP Series

Pad Diameter List

☆: ZP3 series ★: ZP3E series ●: ZP2 series ○: ZP series

Pad type	Symbol	Diameter (mm)																
		0.8	1.1	1.5	2	3	3.5	4	5	6	7	8	9	10	11	13	14	15
Flat	 U	—	—	☆	○	●	☆	○	—	○	—	○	—	○	—	○	—	—
	 MU	—	—	—	● (Note)	—	● (Note)	● (Note)	● (Note)	● (Note)	—	● (Note)	—	● (Note)	—	—	—	● (Note)
	 EU	—	—	—	● (Note)	—	—	● (Note)	—	● (Note)	—	●	—	—	—	—	—	●
	 AU	—	—	—	●	●	—	●	—	● (Note)	—	●	—	—	—	—	—	—
Flat with rib	 C	—	—	—	—	—	—	—	●	●	●	—	○	—	○	—	—	
Flat with groove	 UM	—	—	—	—	—	☆	—	☆	—	☆	—	☆	—	☆	—	—	
Bellows type with groove	 BM	—	—	—	—	—	—	—	—	—	—	—	—	—	—	—	—	
Thin flat (pad)	 UT	—	—	—	—	—	—	—	●	●	—	—	○	●	○	●	—	
Thin flat with rib	 CT	—	—	—	—	—	—	—	—	—	—	—	○	—	○	—	—	
Bellows (pad)	 B	—	—	—	—	—	☆	—	○	☆	○	☆	—	☆	—	☆	—	
	 J	—	—	—	—	—	—	—	●	—	—	●	● (Note)	—	—	●	● (Note)	
	 MB	—	—	—	—	—	● (Note)	—	● (Note)	—	● (Note)	—	● (Note)	—	—	—	● (Note)	
	 ZJ	—	—	—	●	—	—	●	●	●	—	—	—	—	—	—	—	—
Deep	 D	—	—	—	—	—	—	—	—	—	—	—	○	—	—	—	—	
Nozzle pad	 AN	●	●	—	—	—	—	—	—	—	—	—	—	—	—	—	—	
Flat pad	 MT	—	—	—	—	—	—	—	—	—	—	—	● (Note)	—	—	—	● (Note)	
Oval pad	 W	—	—	—	—	—	3.5 x 7	4 x 10 4 x 20 4 x 30	5 x 10 5 x 20 5 x 30	6 x 10 6 x 20 6 x 30	—	8 x 20 8 x 30	—	—	—	—	—	
	 U	—	—	—	2 x 4 ○	—	3.5 x 7 ○	4 x 10 ○	—	—	—	—	—	—	—	—	—	—
Flat	 H	—	—	—	—	—	—	—	—	—	—	—	—	—	—	—	—	—
	 HT	—	—	—	—	—	—	—	—	—	—	—	—	—	—	—	—	—
Heavy-duty pad	 HB	—	—	—	—	—	—	—	—	—	—	—	—	—	—	—	—	—
	 HW	—	—	—	—	—	—	—	—	—	—	—	—	—	—	—	—	—
Mark-free pad	 U	—	—	—	—	—	—	●	—	●	—	●	—	●	—	—	—	—
	 H	—	—	—	—	—	—	—	—	—	—	—	—	—	—	—	—	—
Sponge pad	S	—	—	—	—	—	—	—	●	—	●	—	●	—	—	—	—	●
Resin attachment	K	—	—	—	—	—	—	—	—	●	—	●	—	●	—	●	—	—
Pad with ball spline buffer	U	—	—	—	●	—	—	●	—	●	—	●	—	—	—	—	—	—
Heavy-duty ball joint pad	H	—	—	—	—	—	—	—	—	—	—	—	—	—	—	—	—	—
	HB	—	—	—	—	—	—	—	—	—	—	—	—	—	—	—	—	—

Non-contact gripper **Made to Order**

Note) The ZP2 series is blast type.

* The ZP3 series is available from ø1.5 to ø16. If you need other sizes or shapes, choose from the ZP or ZP2 series.

Pad diameter																	Symbol	Page of ZP3	Page of ZP3E	Page of ZP2	Page of ZP
16	18	20	25	30	32	40	46	50	63	80	100	125	150	250	300	340					
○	—	○	○	—	○	○	—	○	—	—	—	—	—	—	—	—	U	P.324	—	P.528	P.637
—	—	—	—	—	—	—	—	—	—	—	—	—	—	—	—	—	MU	—	—	P.529	—
—	—	—	—	—	—	—	—	—	—	—	—	—	—	—	—	—	EU	—	—	P.532	—
—	—	—	—	—	—	—	—	—	—	—	—	—	—	—	—	—	AU	—	—	P.535	—
○	—	○	○	—	○	○	—	○	—	—	—	—	—	—	—	—	C	—	—	P.528	P.637
☆	—	—	—	—	★	★	—	★	★	★	★	★	—	—	—	—	UM	P.324	P.404	—	—
—	—	—	—	—	★	★	—	★	★	★	★	★	—	—	—	—	BM	—	P.404	—	—
○	●	●	—	—	—	—	—	—	—	—	—	—	—	—	—	—	UT	—	—	P.528 P.537	P.637
○	—	—	—	—	—	—	—	—	—	—	—	—	—	—	—	—	CT	—	—	—	
○	☆	—	○	○	—	○	○	—	○	—	—	—	—	—	—	—	B	P.324	—	P.528	—
●	—	—	● (Note)	● (Note)	—	—	—	—	—	—	—	—	—	—	—	—	J	—	—	P.540	—
—	—	●	—	—	—	—	—	—	—	—	—	—	—	—	—	—	MB	—	—	P.541	—
—	—	—	—	—	—	●	●	—	—	—	—	—	—	—	—	—	ZJ	—	—	P.543	—
○	—	—	○	—	—	○	—	—	—	—	—	—	—	—	—	—	D	—	—	—	P.637
—	—	—	—	—	—	—	—	—	—	—	—	—	—	—	—	—	AN	—	—	P.536	—
—	—	● (Note)	● (Note)	● (Note)	—	—	—	—	—	—	—	—	—	—	—	—	MT	—	—	P.538	—
—	—	—	—	—	—	—	—	—	—	—	—	—	—	—	—	—	W	—	—	P.550	—
—	—	—	—	—	—	—	—	—	—	—	—	—	—	—	—	—	U	—	—	—	P.637
—	—	—	—	—	●	○	—	○	○	○	○	○	—	—	●	●	H	—	—	P.566	P.582
—	—	—	—	—	—	—	—	—	—	—	—	—	●	●	—	—	HT	—	—	P.566	—
—	—	—	—	—	●	○	—	○	○	○	○	○	●	—	—	—	HB	—	—	P.568	P.582
—	—	—	—	30 x 50 ●	—	—	—	—	—	—	—	—	—	—	—	—	HW	—	—	P.569	—
●	—	—	●	—	●	●	—	●	—	—	—	—	—	—	—	—	U	—	—	P.560	—
—	—	—	—	—	—	●	—	●	●	●	●	●	—	—	—	—	H	—	—	P.561	—
—	—	—	—	—	—	—	—	—	—	—	—	—	—	—	—	—	S	—	—	P.563	—
●	—	●	●	—	●	—	—	—	—	—	—	—	—	—	—	—	K	—	—	P.562	—
—	—	—	—	—	—	—	—	—	—	—	—	—	—	—	—	—	U	—	—	P.557	—
—	—	—	—	—	—	●	—	●	●	●	●	●	—	—	—	—	H	—	—	P.570	—
—	—	—	—	—	—	●	—	●	●	●	●	●	—	—	—	—	HB	—	—	P.576	—

■ Products other than above

Vacuum pad for transferring disks...P.592



Vacuum pad for fixing panel...P.593



Vacuum saving valve...P.627



Vacuum Pad ZP3 Series

Overall length is shortened. In the case of Flat type (Pad diameter: $\phi 2$)

Pad unit Max. **9 mm shortened**

With adapter Max. **11 mm shortened**

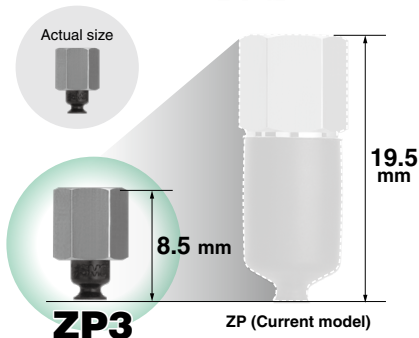
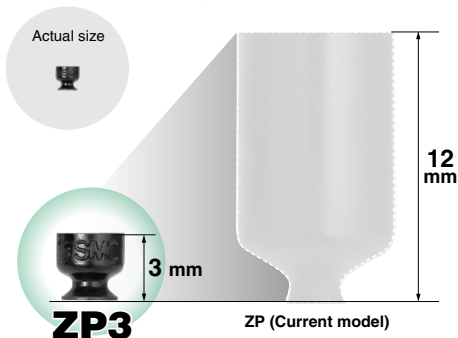

Space-saving $\phi 2$ piping reduces working space!

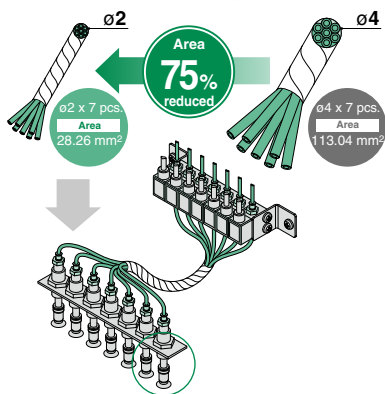

Vertical

- Male thread
- Female thread
- Barb fitting (Applicable tubing: $\phi 2$)
- One-touch fitting (Applicable tubing: $\phi 2$)

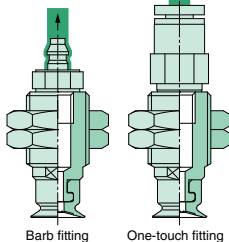

Lateral

- Female thread
- Barb fitting (Applicable tubing: $\phi 2$)
- One-touch fitting (Applicable tubing: $\phi 2$)

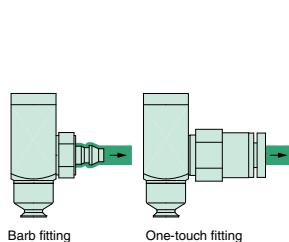

Variations Pad diameter $\phi 1.5$ added!

Type	Pad diameter									
	$\phi 1.5$	$\phi 2$	$\phi 3.5$	$\phi 4$	$\phi 6$	$\phi 8$	$\phi 10$	$\phi 13$	$\phi 16$	
Flat	●	●	●							
Flat with groove				●	●	●	●	●	●	
Bellows				●	●	●	●	●	●	



Excellent functions

Excellent functions

Adsorption surface is shot-blasted

Micro-dents and bumps on the surface facilitate easy removal.

With groove

Less contact surface with the workpiece makes it easy to remove.

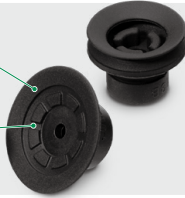

Construction to prevent pad from coming off

New shape for connecting with the adapter prevents the pad from coming off.



Pad diameter from $\phi 1.5$

Easier identification

SMC logo mark



Fixing boss allows easy mounting and repeatability.



Fixing boss

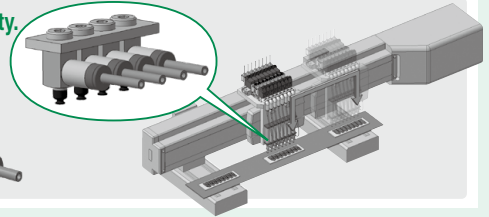
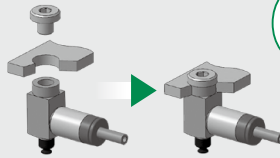

Compact buffer body

Overall length is shortened.



ZP3



ZP

* Lateral vacuum inlet

Pad diameter $\phi 8$, Flat, With One-touch fitting

ZP3

Stroke	Overall length (mm)
3	40
6	46
10	56
15	59
20	66.5
25	—

ZP

Stroke	Overall length (mm)
3	—
6	78.5
10	109.5
15	114.5
20	—
25	124.5

Short stroke type: 3 mm added

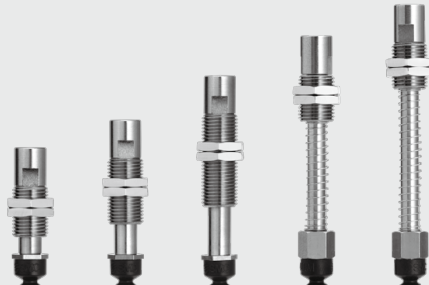

3 mm

6 mm

10 mm

15 mm

20 mm

Buffer stroke

(* With bushing)

Pad diameter	Buffer specifications	Stroke (mm)				
		3	6	10	15	20
$\phi 1.5, \phi 2, \phi 3.5$	Rotating, Non-rotating	●	●	—	—	—
	Rotating	●	●	—	—	—
$\phi 4, \phi 6, \phi 8$ $\phi 10, \phi 13, \phi 16$	Rotating, With bushing	—	—	—	●	●
	Non-rotating	●	●	●	●	●

Wide selection of piping

Male thread

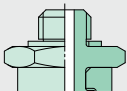

Female thread

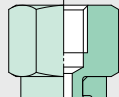

Barb fitting





For $\phi 2$ piping!









One-touch fitting

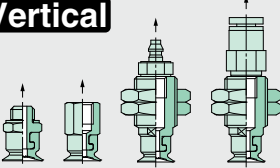

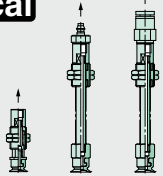
Vacuum Pad ZP3 Series Variations

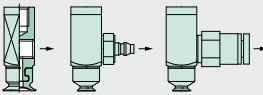
Type	Pad diameter									Material	Page
	ø1.5	ø2	ø3.5	ø4	ø6	ø8	ø10	ø13	ø16		
 <p>Flat For adsorption of general workpieces For adsorption of work pieces with flat and not deformed surface</p>	●	●	●							NBR Silicone rubber Urethane rubber FKM Conductive NBR Conductive silicone rubber	P.297
 <p>Flat with groove For a workpiece which is likely to deform For releasing a workpiece certainly</p>				●	●	●	●	●	●		
 <p>Bellows For adsorption of work pieces with inclined surface</p>				●	●	●	●	●	●		

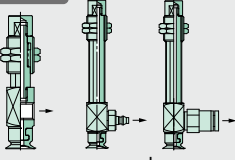

Vacuum inlet direction	Buffer attachment	Vacuum inlet		Page
Vertical  ZP3-T <input type="checkbox"/> <input type="checkbox"/> <input type="checkbox"/> <input type="checkbox"/>	Without buffer (with adapter)	Male thread	M3, M5	
		Female thread	M3, M5	
		Barb fitting	Polyurethane tubing ø2 Soft nylon/ Polyurethane tubing ø4, ø6	
		One-touch fitting	ø2, ø4, ø6	
Vertical  ZP3-T <input type="checkbox"/> <input type="checkbox"/> <input type="checkbox"/> <input type="checkbox"/> <input type="checkbox"/> <input type="checkbox"/>	Stroke with buffer 3 mm 6 mm 10 mm 15 mm 20 mm	Female thread	M3, M5	
		Barb fitting	Polyurethane tubing ø2 Soft nylon/ Polyurethane tubing ø4, ø6	
		One-touch fitting	ø2, ø4, ø6	
Lateral  ZP3-Y <input type="checkbox"/> <input type="checkbox"/> <input type="checkbox"/> <input type="checkbox"/> <input type="checkbox"/>	Without buffer (with adapter)	Female thread	M3, M5	
		Barb fitting	Polyurethane tubing ø2 Soft nylon/ Polyurethane tubing ø4, ø6	
		One-touch fitting	ø2, ø4, ø6	
Lateral  ZP3-Y <input type="checkbox"/> <input type="checkbox"/> <input type="checkbox"/> <input type="checkbox"/> <input type="checkbox"/> <input type="checkbox"/>	Stroke with buffer 3 mm 6 mm 10 mm 15 mm 20 mm	Female thread	M3, M5	
		Barb fitting	Polyurethane tubing ø2 Soft nylon/ Polyurethane tubing ø4, ø6	
		One-touch fitting	ø2, ø4, ø6	

Vacuum Pad ZP3E Series

Stability of suction position

Groove and rib formed to adsorb with entire surface

- Groove on the adsorption surface secures the interior space.
- Ribs reduce the inclinations during transport of workpiece.



ZP (Current model/Bellows pad)

ZP3E (Bellows pad)

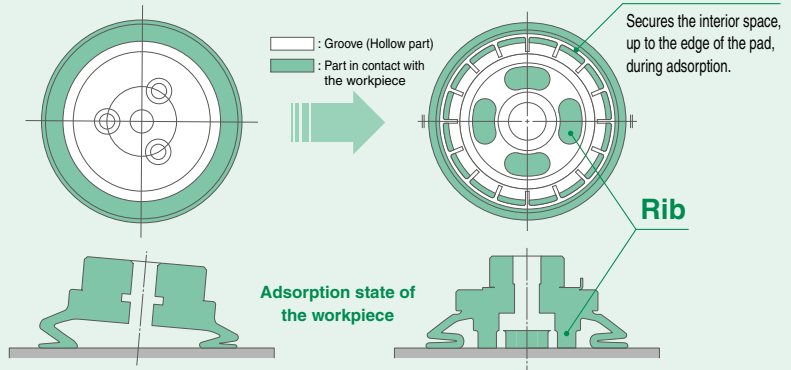

Improved ease of removal

With groove

Dents and bumps on the adsorption surface prevent the workpiece from sticking to it. This facilitates easy removal.

Shot-blasted

Micro-dents and bumps are formed on the adsorption surface. Workpieces can be removed easily.

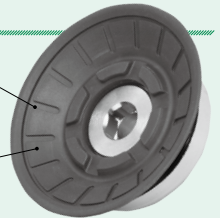

The number of mounting screws reduced

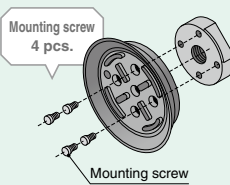

ZP series (Heavy-duty type)

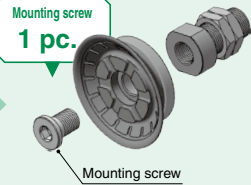

ZP3E Series

Can be disposed of separately.

The rubber pad and metal part can be separated.

The metal parts and rubber parts can be separated completely.

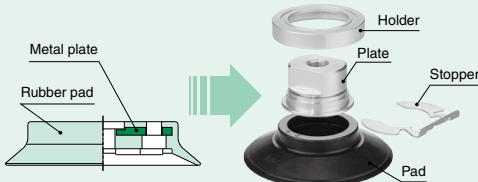

ZP series (Heavy-duty type)

ZP3E Series

Mark-free

For use where adsorption marks must not be left on workpieces.

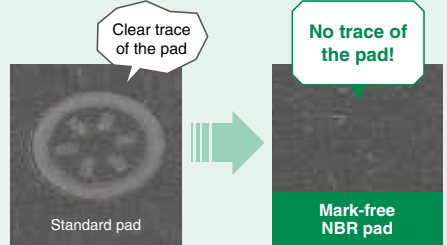

Suction flow rate increased

Applicable to workpieces with a large suction flow rate and high permeability, and vacuum blow pumps with large suction flow rates.

Double suction port size
(Pad diameter: $\phi 63, \phi 80$
Compared with the ZP series)

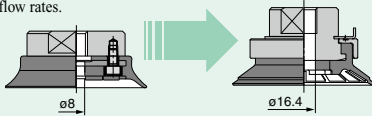

ZP (Current model)			ZP3E	
Pad diameter	Suction port	Area [mm ²]	Suction port	Area [mm ²]
ø32	—	—	—	—
ø40	—	—	—	—
ø50	ø6	28.3	ø8.4	55.4
ø63	—	—	—	—
ø80	ø8	50.2	—	—
ø100	—	—	—	—
ø125	ø10	78.52	ø16.4	211

Ball joint type pad weight reduced

Weight reduced by changing the internal structure and materials
* The pad material when weight was measured is NBR.

Weight reduced by up to 290 g



ZP2/Flat type		ZP3E/Flat type with groove
Pad diameter	Weight [g]	Weight [g]
ø32	—	56
ø40	91	57
ø50	110	75
ø63	230	150
ø80	270	160
ø100	430	190
ø125	560	270

Direct mounting with male thread added

Direct mounting

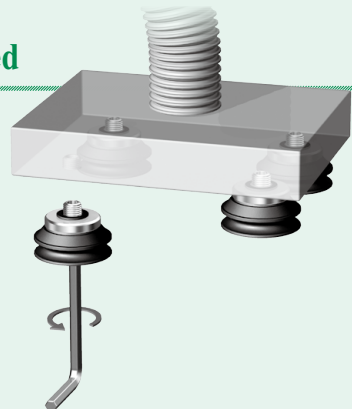
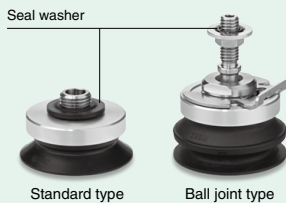

- Reduced in height
- Easy mounting with tightening with a hexagonal wrench

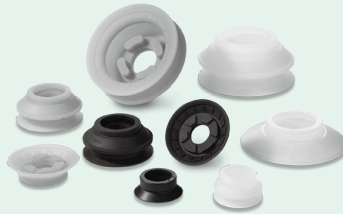

Vacuum Pad ZP3E Series Variations

Pad Unit Variations



Form	Pad diameter							Material	Page
	ø32	ø40	ø50	ø63	ø80	ø100	ø125		
 <p>Flat type with groove For adsorption of general workpieces. To be used when adsorption surface of the workpiece is flat and not deformed.</p> <p>ZP3E-□UM-□</p>	●	●	●	●	●	●	●	NBR Silicone rubber Urethane rubber FKM Mark-free NBR	P.404
 <p>Bellows type with groove To be used when adsorption surface of the workpiece is slanted.</p> <p>ZP3E-□BM-□</p>	●	●	●	●	●	●	●		P.404



With Adapter Variations

Standard Type

















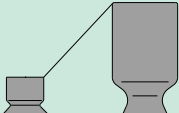

















Ball Joint Type











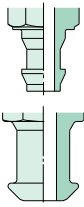







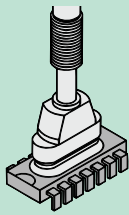



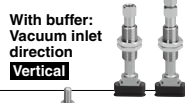

Vacuum inlet direction Mounting	Mounting thread size	Buffer attachment	Page
Vertical Male thread/Direct mounting ZP3E-T□□□-□	M10 M16	Without buffer	P.408
Vertical Male thread/Plate connection ZP3E-T□□□-□	M14 M16		P.408
Vertical Female thread mounting ZP3E-T□□□-□	M8 M10 M12 M18		P.408
Lateral Male thread mounting ZP3E-Y□□□-□	M14 M16		P.420
Lateral Female thread mounting ZP3E-Y□□□-□	M8 M12		P.420
Vertical Male thread mounting ZP3E-T□□□JB□	M18 M22		With buffer
Lateral Male thread mounting ZP3E-Y□□□JB□		Stroke · 10 mm · 30 mm · 50 mm	P.432



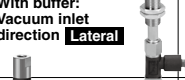









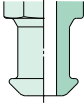

Vacuum inlet direction Mounting	Mounting thread size	Buffer attachment	Page
Vertical Male thread/Direct mounting ZP3E-TF□□□-□	M6 M12	Without buffer	P.436
Vertical Male thread/Plate connection ZP3E-TF□□□-□	M14 M16		P.436
Vertical Female thread mounting ZP3E-TF□□□-□	M8 M12		P.436
Lateral Male thread mounting ZP3E-YF□□□-□	M14 M16		P.449
Lateral Female thread mounting ZP3E-YF□□□-□	M8 M12		P.449
Vertical Male thread mounting ZP3E-TF□□□JB□	M18 M22		With buffer
Lateral Male thread mounting ZP3E-YF□□□JB□		Stroke · 10 mm · 30 mm · 50 mm	P.463

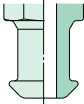
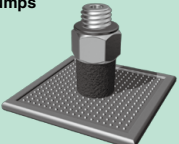

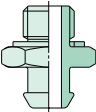

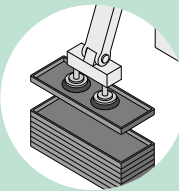

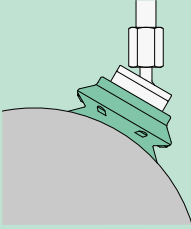

Vacuum Pad ZP2 Series Variations

Variations	Symbol	Pad		Adapter type	Page	
		Type	Diameter			
Compact Pad <ul style="list-style-type: none"> ● Flat For adsorption of general work pieces For adsorption of work pieces with flat and not deformed surface ● Flat with rib For a workpiece which is likely to deform or for releasing a workpiece certainly ● Thin flat For a workpiece which is likely to deform ● Bellows For adsorption of work pieces with inclined surface 	 Single unit	U	Flat	ø3, ø4	 ZP Series Common adapter	P.528
	 Single unit	C	Flat with rib	ø6, ø7, ø8		
	 Single unit	UT	Thin flat	ø5, ø6		
	 Single unit	B	Bellows	ø6, ø8		
Short-type Pad <ul style="list-style-type: none"> ● Space-saving in the height direction 	 Single unit	MU	Flat	ø2, ø3.5, ø4 ø5, ø6, ø8 ø10, ø15		P.529
	 With adapter					
	 Single unit	EU	Flat	ø2, ø4, ø6 ø8, ø15		P.532
 Single unit	 Single unit	AU	—	ø2, ø3, ø4 ø6, ø8	—	P.535
	 With adapter	AN	Nozzle	ø0.8, ø1.1		P.536
Thin Flat Pad <ul style="list-style-type: none"> ● For adsorption of soft work pieces such as thin sheets or vinyl. Wrinkling or deformation during adsorption is reduced. 	 Single unit	UT	Thin flat (Skirt)	ø5, ø6, ø11 ø14, ø18 ø20	 ZP Series Common adapter	P.537
Flat Pad <ul style="list-style-type: none"> ● For adsorption of flexible sheets or film. Deformation of the flat surface during adsorption is reduced. 	 Single unit	MT	Thin flat (With groove)	ø10, ø15 ø20, ø25 ø30		P.538
	 With adapter					
Bellows Pad <ul style="list-style-type: none"> ● For use where there is no space for the buffer (spring type). For adsorption of work pieces with inclined surface 	 Single unit	J	Bellows (Multistage type)	ø6, ø9, ø10 ø14, ø15 ø16, ø25 ø30	 ZP Series Common adapter	P.540
	 Single unit	MB	Bellows	ø4, ø6, ø8 ø10, ø15 ø20		P.541
	 With adapter					
	 Single unit	ZJ	Bellows	ø2, ø4, ø5 ø6, ø40, ø46	—	—
 With adapter						
 Single unit	 With adapter			ø15, ø20 ø30, ø40 ø46		P.544



Variations	Symbol	Pad		Adapter type	Page
		Type	Diameter		
Blast-type Pad ● Blast treatment to create finely uneven surface for adsorption. Work pieces can be removed easily.	 Single unit U	Flat	ø4	 ZP Series Common adapter	 P.528
	 Single unit C	Flat with rib	ø6, ø8		
	 Single unit B	Bellows	ø6, ø8		
	 Single unit J	Bellows (Multistage type)	ø10, ø15 ø25, ø30		
	 Single unit With adapter MU	Flat	ø2, ø3.5, ø4 ø5, ø6, ø8 ø10, ø15		
	 Single unit With adapter EU	Flat	ø2, ø4, ø6		
	 Single unit With adapter MT	Thin flat (With groove)	ø10, ø15 ø20, ø25 ø30		
	 Single unit With adapter MB	Bellows	ø4, ø6, ø8 ø10, ø15 ø20		
Oval Pad ● For work pieces with limitations on the adsorption surface 	 Single unit W		3.5 x 7		 P.550
	 With adapter: Vacuum inlet direction Vertical		4 x 10 5 x 10 6 x 10		 P.551
	 With buffer: Vacuum inlet direction Vertical		4 x 20 5 x 20 6 x 20 8 x 20		 P.552
	 With adapter: Vacuum inlet direction Lateral		4 x 30 5 x 30 6 x 30 8 x 30		 P.554
	 With buffer: Vacuum inlet direction Lateral				 P.556
Pad with Ball Spline Buffer ● Ball spline guide is used to the buffer.	 With buffer: Vacuum inlet direction Vertical U	Flat	ø2, ø4 ø6, ø8	 ZP Series Common adapter	 P.557

Vacuum Pad ZP2 Series Variations





Variations	Symbol	Pad		Adapter type	Page	
		Type	Diameter			
<p>Mark-free Pad</p> <ul style="list-style-type: none"> For use where adsorption marks must not be left on work pieces. <div style="display: flex; justify-content: space-around;"> <div style="text-align: center;"> <p>Standard pad</p>  <p>Clear trace of the pad</p> </div> <div style="text-align: center;"> <p>Mark-free pad</p>  <p>No trace on the object</p> </div> </div> <ul style="list-style-type: none"> Mark-free NBR pad Stuck fluoro-resin pad  <p>Related Pad <i>Made to Order</i> Non-contact gripper P.727</p>	 Single unit	U	Flat	ø4, ø6, ø8 ø10, ø16 ø25, ø32 ø40, ø50	 ZP Series Common adapter	P.560
<p>Resin Attachment</p> <ul style="list-style-type: none"> Mark-free. Prevents sticking of the rubber and the workpiece.  <p>Attachment</p>	 Single unit	—	Bellows	ø6, ø8 ø10, ø13 ø16, ø20 ø25, ø32	 ZP Series Common adapter	P.562
<p>Sponge Pad</p> <ul style="list-style-type: none"> For adsorption of work pieces with bumps 	 Single unit	S	Sponge	ø4, ø6 ø8, ø10 ø15		P.563
 With adapter	P.564					
<p>Heavy-duty Pad</p> <ul style="list-style-type: none"> For heavy or large work pieces 	 Single unit	H	Heavy-duty (Flat with rib)	ø32, ø300 ø340	—	P.566
	 Single unit	HT	Heavy-duty (Thin flat with rib)	ø150, ø250		P.568
	 Single unit	HB	Heavy-duty (Bellows)	ø32, ø150		P.569
	 Single unit	HW	Heavy-duty (Oval)	30 x 50		P.569

Variations	Symbol	Pad		Page	
		Type	Diameter		
<p>Heavy-duty Ball Joint Pad</p> <p>● For adsorption of work pieces with inclined or curved surface</p> 	H	Heavy-duty (Flat with rib)	ø40 ø50 ø63 ø80 ø100 ø125	 With adapter: Vacuum inlet direction Vertical	P.570
				 With adapter: Vacuum inlet direction Lateral	P.571
				 With buffer: Vacuum inlet direction Vertical	P.572
				 With buffer: Vacuum inlet direction Lateral	P.574
				 With adapter: Vacuum inlet direction Vertical	P.576
	HB	Heavy-duty (Bellows)	ø40 ø50 ø63 ø80 ø100 ø125	 With adapter: Vacuum inlet direction Lateral	P.577
				 With buffer: Vacuum inlet direction Vertical	P.578
				 With buffer: Vacuum inlet direction Lateral	P.580

Vacuum Pad ZP Series Variations/Applications (Pad/Adapter)

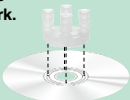
Variations	Symbol	Pad		Adapter type	Page
		Type	Diameter		
Heavy-duty Pad <ul style="list-style-type: none"> ● Heavy-duty type (Flat with rib) Ideal for heavy or large work pieces such as CRT and automobile bodies ● Heavy-duty type (Bellows) <ul style="list-style-type: none"> • Ideal for work pieces with curved surface • Ideal for heavy or large work pieces 		H	Heavy-duty (Flat with rib)	ZP Series Common adapter	P.582
		HB	Heavy-duty (Bellows)		

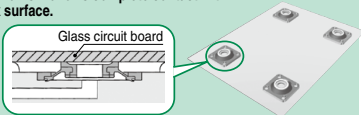
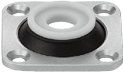
Applications (Pad/Adapter)

Variations		Note	Page
Vacuum Pad for Transferring Disks <ul style="list-style-type: none"> ● For adsorbing circular components like CD and DVD ● Bellows mechanism is realized in the pad to dampen the impact to the work. 		20 x 25 (ID x OD: PCD 22.5)	P.592
Vacuum Pad for Fixing Panel <ul style="list-style-type: none"> ● For adsorbing and fixing the stage of panels or glass circuit board, etc. ● Bellows mechanism allows complete contact with curved work surface. 		—	P.593
Vacuum Saving Valve <ul style="list-style-type: none"> ● Can restrict the reduction of vacuum pressure even when there is no workpiece. ● No need for switching operation when changing work pieces ● Multiple vacuum pads can be operated by one ejector. 		Connection thread size for pad side ● M5 x 0.8 ● M6 x 1 ● M8 x 1.25 ● R1/8 ● Rc1/8 ● G1/8 ● NPT1/8	P.627

ZP2/ZP Series Adapter/Buffer Applicable Pad List **P.595**

ZP Series Adapter Assembly Part No. **P.611**

ZP2 Series Mounting Adapter Part No. **P.602**











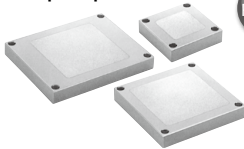

ZP2 Series Buffer Assembly Part No. **P.613**

ZP Series Mounting Adapter Part No. **P.607**

ZP Series Buffer Assembly Part No. **P.622**

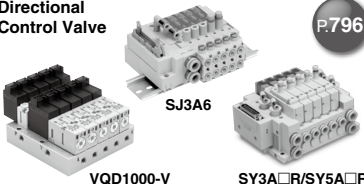
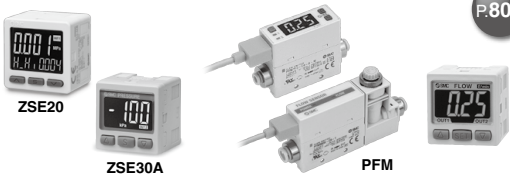
ZP2 Series Adapter Assembly Part No. **P.610**

Related Equipment

Series	<p>SP</p> <p>Adsorption plate P.749</p> 	<p>ZCUK</p> <p>Free Mount Cylinder for Vacuum P.759</p> 	<p>AMJ</p> <p>Drain Separator for Vacuum P.773</p> 	
	Features	<ul style="list-style-type: none"> • Ideal for adsorption and fixing in place of thin sheets, glass panels, and soft workpieces. Workpieces do not deform since they are adsorbed with multiple micro air vents on the adsorption surface. • A high level of machining accuracy. • Strong adsorption force. 	<ul style="list-style-type: none"> • In the rectangular, compact cylinder CU series which has a high level of mounting precision, a vacuum passage is provided in the rod to facilitate the mounting of a vacuum pad, and save space. • Standard vacuum pads (ø2 to ø50) can be mounted. 	<ul style="list-style-type: none"> • Removes water droplets from air by simply installing in vacuum equipment connection lines. • Effective for removing water droplets from the air sucked into vacuum pumps and ejectors, etc.
Series	<p>AFJ</p> <p>Vacuum Filter P.779</p> 	<p>AMV</p> <p>Exhaust Cleaner for Vacuum Pump P.788</p> 	<p>ZH□-□□-X185</p> <p>Vacuum Flow P.790</p> 	
	Features	<ul style="list-style-type: none"> • Prevents vacuum equipment trouble! • Elements can be reused by washing them. • Water drops can be removed • The bowl is covered with a transparent bowl guard! 	<ul style="list-style-type: none"> • Captures 99.5% of oil mist exhausted from the vacuum pump. • Creates a comfortable working environment without oil mist. • Captures and separates 99.5% of highly concentrated oil mist with a low flow rate. • No need for an exhaust duct from the vacuum pump. 	<ul style="list-style-type: none"> • A discharge flow rate 4 times the supply air can be generated. • A suction flow rate 3 times the supply air can be generated. • Contributes to reduction in flow consumption if discharge and suction requires flow rate.
Related Equipment for Vacuum System				
Series	<p>Vacuum Regulator P.795</p>  <p>IRV</p>	<p>Electronic Vacuum Regulator P.795</p>  <p>ITV209□</p>	<p>Directional Control Valve P.796</p>  <p>VQD1000-V SJ3A6 SY3A□R/SY5A□R</p>	
	<p>Vacuum Pressure Switch/Flow Switch P.801</p>  <p>ZSE20 ZSE30A PFM</p>	<p>Vacuum Pressure Gauge P.802</p>  <p>GZ46 GZ46-K2K</p>		
	<p>Flow Control Equipment P.804</p>  <p>AS AKH</p>	<p>Made to Order P.804</p>  <ul style="list-style-type: none"> • Vacuum release valve with throttle valve: SY5A2R..... P.805 • Vacuum release valve with throttle valve: SV1A4R-X8... P.809 		

Adsorption Transfer System by Ejector

Ejector Module System

Equipment (ejector supply valve, release valve, throttle valve, vacuum pressure switch, and filter) that is needed for the ejector adsorption transfer system has been integrated to achieve efficient assembly work and a compact design.

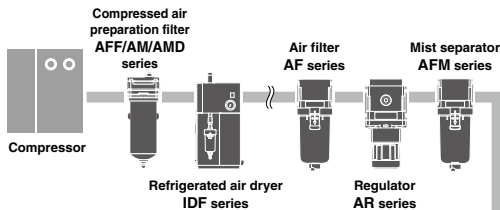

Ejector module/Circuit

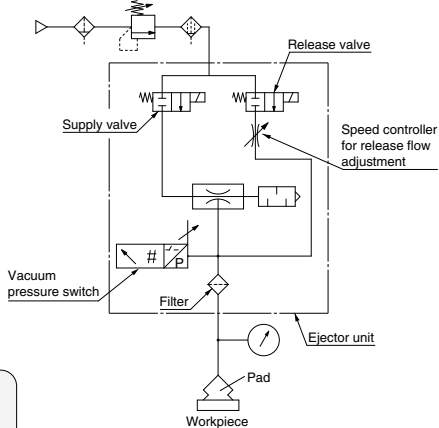

Ejector module ZK2, ZB, ZR, ZQ, ZL

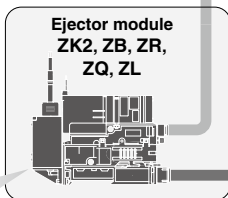

For the ZK2, ZB, ZR, ZQ and ZL, the combination of single units at right can be integrated into a unit.

Flow switch PF2M series

Air suction filter ZF series AMJ series AFJ series

Removes dust that is present in air that has been drawn in.

Pressure gauge for vacuum GZ series ZSE series PSE series



Adsorption Transfer System by Ejector

Single Unit System

Equipment such as an ejector is configured as an individual unit. Thus, it is possible to create a flexible system configuration in which the circuit composition and the mounting locations can be selected as desired.

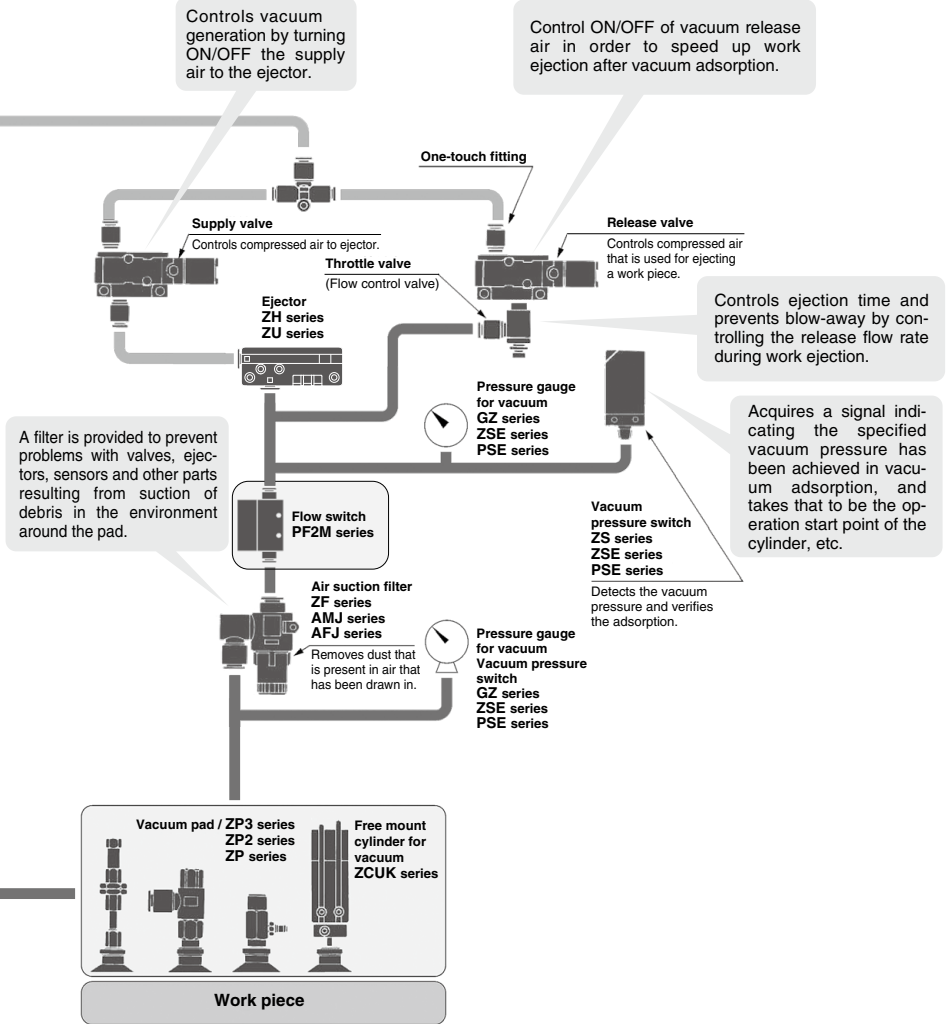

Adsorption Transfer System for Vacuum Pump

Equipment (vacuum switching valve, release valve, throttle valve, vacuum pressure switch, and filter) that is needed for controlling the vacuum pressure has been integrated to achieve efficient assembly work and a compact design.

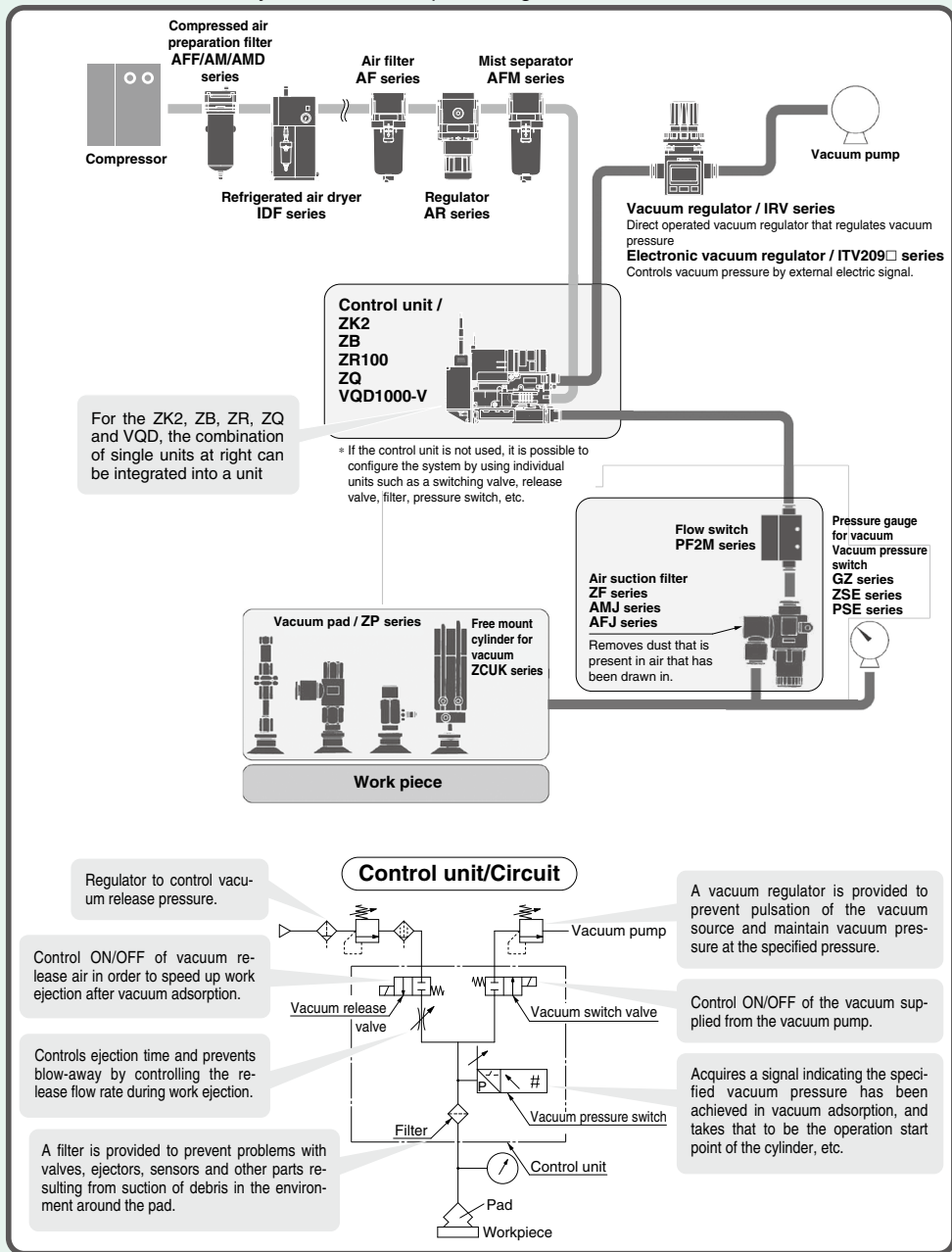

Vacuum Equipment Model Selection

CONTENTS

1	Features and Precautions for Vacuum Adsorption	P.26
2	Vacuum Pad Selection	P.26
	<ul style="list-style-type: none">● Vacuum Pad Selection Procedures● Points for Selecting Vacuum Pads<ul style="list-style-type: none">A. Theoretical Lifting ForceB. Shear Force and Moment Applied to Vacuum Pad● Lifting Force and Vacuum Pad Diameter<ul style="list-style-type: none">1. Theoretical Lifting Force● Vacuum Pad Type● Vacuum Pad Material● Rubber Material and Properties● Color and Identification● Buffer Attachment● Pad Selection by Workpiece Type● Vacuum Pad Durability	
3	Selection of Vacuum Ejector and Vacuum Switching Valve	P.33
	<ul style="list-style-type: none">● Calculating Vacuum Ejector and Switching Valve Size with the Formula	
4	Leakage Volume during Workpiece Adsorption	P.33
	<ul style="list-style-type: none">● Leakage Volume from Conductance of Workpiece● Leakage Volume from Adsorption Test	
5	Adsorption Response Time	P.34
	<ul style="list-style-type: none">● Relationship between Vacuum Pressure and Response Time after Supply Valve (Switching Valve) is Operated● Calculating Adsorption Response Time with the Formula● Adsorption Response Time from the Selection Graph	
6	Precautions on Vacuum Equipment Selection and SMC's Proposal	P.36
	<ul style="list-style-type: none">● Safety Measures● Precautions on Vacuum Equipment Selection● Vacuum Ejector or Pump and Number of Vacuum Pads● Vacuum Ejector Selection and Handling Precautions● Supply Pressure of Vacuum Ejector● Timing for Vacuum Generation and Suction Verification<ul style="list-style-type: none">A. Timing for Vacuum GenerationB. Suction VerificationC. Set Pressure for Vacuum Pressure Switch● Dust Handling of Vacuum Equipment	
7	Vacuum Equipment Selection Example	P.40
	<ul style="list-style-type: none">● Transfer of Semiconductor Chips	
8	Data	P.41
	<ul style="list-style-type: none">● Selection Graph● Glossary of Terms● Countermeasures for Vacuum Adsorption System Problems (Troubleshooting)● Non-conformance Examples● Time of Replacement of Vacuum Pad	

Model Selection

1 Features and Precautions for Vacuum Adsorption

Vacuum adsorption system as a method to hold a workpiece has the following features.

- Easy construction
- Compatible with any place where adsorption is possible.
- No need for accurate positioning
- Compatible with soft and easily-deformed work pieces

However, special care is required in the following conditions.

- Workpiece may drop under certain conditions since it is transferred being adsorbed.
- Liquid or foreign matter around the workpiece may be sucked into the equipment.
- Large adsorption area is necessary to get large gripping force.
- Vacuum pad (rubber) may deteriorate.

Fully understand the features above and select the equipment that suits your operating conditions.

2 Vacuum Pad Selection

● Vacuum Pad Selection Procedures

- 1) Fully taking into account the balance of a workpiece, identify the adsorption positioning, number of pads and applicable pad diameter (or pad area).
- 2) Find the theoretical lifting force from the identified adsorption area (pad area x number of pads) and vacuum pressure, and then find the lifting force considering actual lifting and safety factor of transfer condition.
- 3) Determine a pad diameter (or pad area) that is sufficient to ensure the lifting force is greater than the workpiece mass.
- 4) Determine the pad type and materials, and the necessity of buffer based on the operating environment, and the workpiece shape and materials.

The above shows selection procedures for general vacuum pads; thus, they will not be applicable for all pads. Customers are required to conduct a test on their own and to select applicable adsorption conditions and pads based on the test results.

● Points for Selecting Vacuum Pads

A. Theoretical Lifting Force

- The theoretical lifting force is determined by vacuum pressure and adsorption area of the vacuum pad.
- Since the theoretical lifting force is the value measured at the static state, the safety factor responding to the actual operating conditions must be estimated in the actual operation.
- It is not necessarily true that higher vacuum pressure is better. Extremely high vacuum pressure may cause problems.
 - When the vacuum pressure is unnecessarily high, pads are likely to be worn out earlier or cracked, causing shorter pad service life.
 - Doubling the vacuum pressure makes the theoretical lifting force double, while doubling the pad diameter makes the theoretical lifting force quadruple.
 - When the vacuum pressure (set pressure) is high, it makes not only response time longer, but also the necessary energy to generate a vacuum larger.

Example) Theoretical lifting force = Pressure x Area → 2 times

Pad diameter \ Area (cm ²)	Area (cm ²)	Vacuum pressure [-40 kPa]	Vacuum pressure [-80 kPa]
∅20	3.14	Theoretical lifting force 12 N	Theoretical lifting force 25 N
∅40	12.56	Theoretical lifting force 50 N	Theoretical lifting force 100 N

↓ 4 times

B. Shear Force and Moment Applied to Vacuum Pad

- Vacuum pads are not resistant to shear force (parallel force with adsorption surface) and moment.
- Minimize the moment applied to the vacuum pad with the position of the workpiece center of gravity in mind.
- The acceleration rate of the movement must be as small as possible, and make sure to take into consideration the wind pressure and impact. If measures to slow down the acceleration rate are introduced, safety to prevent the workpiece from dropping will improve.
- Avoid lifting the workpiece by adsorbing the vertical side with a vacuum pad (vertical lifting) if possible. When it is unavoidable, a sufficient safety factor must be secured.

Lifting Force, Moment, Horizontal Force

To lift a workpiece vertically, make sure to take into consideration the acceleration rate, wind pressure, impact, etc., in addition to the mass of the workpiece. (Refer to Fig. 1)

Because the pads are susceptible to moments, mount the pad so as not to allow the workpiece to create a moment. (Refer to Fig. 2)

When a workpiece that is suspended horizontally is moved laterally, the workpiece could shift depending on the extent of the acceleration rate or the size of the friction coefficient between the pad and the workpiece. Therefore, the acceleration rate of the lateral movement must be minimized. (Refer to Fig. 3)

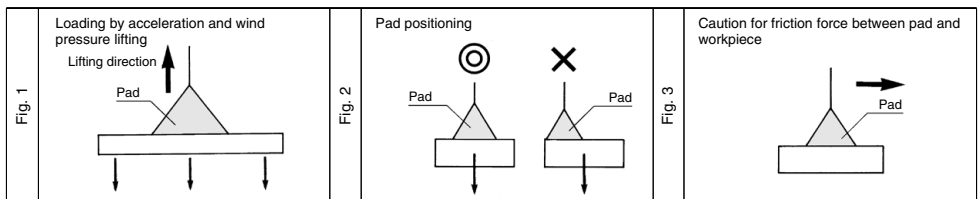

Balance of Pad and Workpiece

Make sure that the pad's suction surface is not larger than the surface of the workpiece to prevent vacuum leakage and unstable picking.

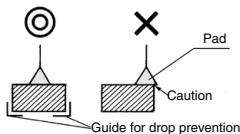

If multiple pads are used for transferring a flat object with a large surface area, properly allocate the pads to maintain balance. Also make sure that the pads are aligned properly to prevent them from becoming disengaged along the edges.

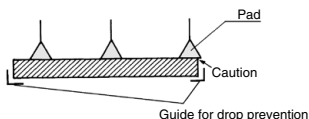

Provide an auxiliary device (example: a guide for preventing the workpieces from dropping) as necessary.

Mounting Position

As a rule, the unit must be installed horizontally. Although a diagonal or a vertical installation should be avoided whenever possible, if the unit must be installed in such a manner, be certain to guarantee guide and absolute safety.

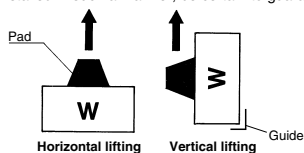

Model Selection

● Lifting Force and Vacuum Pad Diameter

1. Theoretical Lifting Force

- Set the vacuum pressure below the pressure that has been stabilized after adsorption.
- However, when a workpiece is permeable or has a rough surface, note that the vacuum pressure drops since the workpiece takes air in. In such a case, carry out an adsorption test for confirmation.
- The vacuum pressure when using an ejector is approximately -60 kPa as a guide.

The theoretical lifting force of a pad can be found by calculation or from the theoretical lifting force table.

Calculation

$$W = P \times S \times 0.1 \times \frac{1}{t}$$

W : Lifting force (N)
 P : Vacuum pressure (kPa)
 S : Pad area (cm²)
 t : Safety factor Horizontal lifting: 4 or more
 Vertical lifting: 8 or more

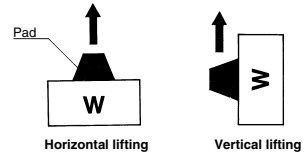

(This type of application should basically be avoided.)

Theoretical Lifting Force

The theoretical lifting force (not including the safety factor) is found from the pad diameter and vacuum pressure. The required lifting force is then found by dividing the theoretical lifting force by the safety factor t.

$$\text{Lifting force} = \text{Theoretical lifting force} \div t$$

(1) Theoretical Lifting Force (Theoretical lifting force = P x S x 0.1)

Pad Diameter (ø1.5 to ø50)

Pad diameter (mm)		ø1.5	ø2	ø3.5	ø4	ø6	ø8	ø10	ø13	ø16	ø20	ø25	ø32	ø40	ø50
Pad area S (cm ²)		0.02	0.03	0.10	0.13	0.28	0.50	0.79	1.33	2.01	3.14	4.91	8.04	12.6	19.6
Vacuum pressure (kPa)	-85	0.15	0.27	0.82	1.07	2.40	4.2	6.6	11	17	26	41	68	106	166
	-80	0.14	0.25	0.77	1.00	2.26	4.0	6.2	10	16	25	39	64	100	157
	-75	0.13	0.24	0.72	0.94	2.12	3.7	5.8	10	15	23	36	60	94	147
	-70	0.12	0.22	0.67	0.88	1.98	3.5	5.5	9.3	14	22	34	56	87	137
	-65	0.11	0.20	0.63	0.82	1.84	3.2	5.1	8.6	13	20	31	52	81	127
	-60	0.11	0.19	0.58	0.75	1.70	3.0	4.7	8.0	12	18	29	48	75	117
	-55	0.10	0.17	0.53	0.69	1.55	2.7	4.3	7.3	11	17	27	44	69	107
	-50	0.09	0.16	0.48	0.63	1.41	2.5	3.9	6.7	10	15	24	40	62	98
	-45	0.08	0.14	0.43	0.57	1.27	2.2	3.5	6.0	9.0	14	22	36	56	88
	-40	0.07	0.13	0.38	0.50	1.13	2.0	3.1	5.3	8.0	12	19	32	50	78

Pad Diameter (ø63 to ø340)

Pad diameter (mm)		ø63	ø80	ø100	ø125	ø150	ø200	ø250	ø300	ø340
Pad area S (cm ²)		31.2	50.2	78.5	122.7	176.6	314.0	490.6	706.5	907.5
Vacuum pressure (kPa)	-85	265	427	667	1043	1501	2669	4170	6005	7714
	-80	250	402	628	982	1413	2512	3925	5652	7260
	-75	234	377	589	920	1325	2355	3680	5299	6806
	-70	218	351	550	859	1236	2198	3434	4946	6353
	-65	203	326	510	798	1148	2041	3189	4592	5899
	-60	187	301	471	736	1060	1884	2944	4239	5445
	-55	172	276	432	675	971	1727	2698	3886	4991
	-50	156	251	393	614	883	1570	2453	3533	4538
	-45	140	226	353	552	795	1413	2208	3179	4084
	-40	125	201	314	491	706	1256	1962	2826	3630





Oval Pad (2 x 4 to 8 x 30, 30 x 50)





Pad diameter (mm)		2 x 4	3.5 x 7	4 x 10	5 x 10	6 x 10	4 x 20	5 x 20	6 x 20	8 x 20	4 x 30	5 x 30	6 x 30	8 x 30	30 x 50
Pad area S (cm ²)		0.07	0.21	0.36	0.44	0.52	0.76	0.94	1.12	1.46	1.16	1.44	1.72	2.26	13.07
Vacuum pressure (kPa)	-85	0.60	1.79	3.0	3.7	4.4	6.4	7.9	9.5	12.4	9.8	12.2	14.6	19.2	112
	-80	0.56	1.68	2.8	3.5	4.1	6.0	7.5	8.9	11.6	9.2	11.5	13.7	18.0	105
	-75	0.53	1.58	2.7	3.3	3.9	5.7	7.0	8.4	10.9	8.7	10.8	12.9	16.9	98
	-70	0.49	1.47	2.5	3.0	3.6	5.3	6.5	7.8	10.2	8.1	10.0	12.0	15.8	92
	-65	0.46	1.37	2.3	2.8	3.3	4.9	6.1	7.2	9.4	7.5	9.3	11.1	14.6	85
	-60	0.42	1.26	2.1	2.6	3.1	4.5	5.6	6.7	8.7	6.9	8.6	10.3	13.5	79
	-55	0.39	1.16	1.9	2.4	2.8	4.1	5.1	6.1	8.0	6.3	7.9	9.4	12.4	72
	-50	0.35	1.05	1.8	2.2	2.6	3.8	4.7	5.6	7.3	5.8	7.2	8.6	11.3	66
	-45	0.32	0.95	1.6	1.9	2.3	3.4	4.2	5.0	6.5	5.2	6.4	7.7	10.1	59
	-40	0.28	0.84	1.4	1.7	2.0	3.0	3.7	4.4	5.8	4.6	5.7	6.8	9.0	53

● Vacuum Pad Type

- Vacuum pads are available in flat, deep, bellows, thin flat, with rib, and oval types, etc. Select the optimal shape in accordance with the workpiece and operating environment. Please contact SMC for shapes not included in this catalog.

Pad Type

Pad shape	Application
Flat 	To be used when adsorption surface of work is flat and not deformed.
Flat with rib 	To be used when work is likely to deform or in the case of releasing work certainly.
Deep 	To be used when work is curved shape.
Bellows 	To be used when there is not enough space to install buffer or adsorption surface of work is slanted.
Oval 	To be used when work has limited adsorption surface or long in length and work is required to locate precisely.

Pad shape	Application
Ball joint 	To be used when adsorption surface of work is not horizontal.
Long stroke buffer 	To be used when work height is not even or cushioning toward work is required.
Large 	To be used when work is heavy weight.
Conductive 	As one of the countermeasures against the static electricity, rubber material with reduced resistance is used. For antistatic measures

● Vacuum Pad Material

- It is necessary to determine vacuum pad materials carefully taking into account the workpiece shape, adaptability in the operating environment, effect after being adsorbed, electrical conductivity, etc.
- Based on the workpiece transfer example for each material, select after confirming the characteristics (adaptability) of rubber.

Vacuum Pad/Example of Workpiece Transfer

Material

Material	Application
NBR	Transfer of general workpieces, Corrugated board, Veneer plate, Iron plate and others
Silicone rubber	Semiconductor, Removing from die-casting, Thin workpieces, Food processor
Urethane rubber	Corrugated board, Iron plate, Veneer plate
FKM	Chemical workpieces
Conductive NBR	General workpieces of semiconductor (Static electricity resistance)
Conductive silicone rubber	Semiconductor (Static electricity)

Model Selection

- ◎ = Excellent --- Not affected at all, or almost no effect
- = Good --- Affected a little, but adequate resistance depending on conditions
- △ = Better not to use if possible
- × = Unsuitable for usage. Severely affected.

● Rubber Material and Properties

General name	NBR (Nitrile rubber)	Silicone rubber	Urethane rubber	FKM (Fluoro rubber)	CR (Chloroprene rubber)	EPR (Ethylene-propylene rubber)	Conductive NBR (Nitrile rubber)	Conductive silicone rubber	Conductive silicone sponge	Conductive CR sponge (Chloroprene sponge)	
Main features	Good oil resistance, abrasion resistance, and aging resistance	Excellent heat resistance, and cold resistance	Excellent mechanical strength	Best heat resistance, and chemical resistance	Well balanced weather resistance, ozone resistance, and chemical resistance	Good aging resistance, ozone resistance, and electrical properties	Good oil resistance, abrasion resistance, and aging resistance. Conductive	Very excellent heat resistance, and cold resistance. Conductive	Excellent heat insulation, and impact resilience	Excellent impact resilience, and sound insulation. Flame retardance	
Pure gum property (specific gravity)	1.00-1.20	0.95-0.98	1.00-1.30	1.80-1.82	1.15-1.25	0.86-0.87	1.00-1.20	0.95-0.98	0.4g/cm ³	0.161g/cm ³	
Physical properties of blended gum	Impact resilience	○	◎	◎	△	◎	○	◎	× to △	× to △	
	Abrasion resistance	◎	× to △	◎	◎	◎	○	◎	×	×	
	Tear resistance	○	× to △	◎	○	○	△	○	× to △	×	
	Flex crack resistance	○	× to ○	◎	○	○	○	○	× to ○	×	
	Maximum operation temperature °C	120	200	60	250	150	150	100	200	180	120
	Minimum operation temperature °C	0	-30	0	0	-40	-20	0	-10	-30	-20
	Volume resistivity (Ωcm)	—	—	—	—	—	—	10 ⁴ or less	10 ⁴ or less	4.8 × 10 ⁴	3.8 × 10 ⁴
	Heat aging	○	◎	△	◎	◎	○	○	◎	△	△
	Weather resistance	○	◎	◎	◎	◎	○	○	◎	△	△
	Ozone resistance	△	◎	◎	◎	◎	◎	◎	◎	△	△
Gas permeability resistance	○	× to △	× to △	× to △	○	× to △	○	× to △	×	×	
Chemical resistance Oil resistance	Gasoline/Gas oil	◎	× to △	◎	◎	○	×	◎	× to △	×	×
	Benzene/Toluene	× to △	×	× to △	◎	× to △	×	× to △	×	×	×
	Alcohol	◎	◎	△	△ to ◎	◎	◎	◎	◎	△	△
	Ether	× to △	× to △	×	× to △	× to △	○	× to △	× to △	×	×
	Ketone (MEK)	×	○	×	×	△ to ○	◎	×	○	×	×
Alkaline resistance Acid resistance	Ethyl acetate	× to △	△	× to △	×	× to △	◎	× to △	△	×	×
	Water	◎	○	△	◎	◎	◎	◎	○	○	○
	Organic acid	× to △	○	×	△ to ○	× to △	×	× to △	○	×	×
	Organic acid of high concentration	△ to ○	△	×	◎	○	○	△ to ○	△	×	×
	Organic acid of low concentration	○	○	△	◎	◎	◎	○	○	×	×
Strong alkali	○	◎	×	○	○	◎	○	◎	△	△	
Weak alkali	○	◎	×	○	○	◎	○	◎	△	△	

- * The indicated physical properties, chemical resistance and other numerical values are only approximate values used for reference. They are not guaranteed values.
- The above general characteristics may change according to the working conditions and the working environment.
- When determining the material, carry out adequate confirmation and verification in advance.
- SMC will not bear responsibility concerning the accuracy of data or any damage arising from this data.

● Color and Identification (ZP/ZP2)

General name	NBR (Nitrile rubber)	Silicone rubber	Urethane rubber	FKM (Fluoro-rubber)	CR (Chloroprene rubber)	EPR (Ethylene-propylene rubber)	Conductive NBR (Nitrile rubber)	Conductive silicone rubber	Conductive silicone sponge	Conductive CR sponge (Chloroprene sponge)
Color of rubber	Black	White	Brown	Black	Black	Black	Black	Black	Black	Black
Identification (Dot or stamp)	—	—	—	·Green 1 dot ·(F)	·Red 1 dot ·(C)	·(E)	·Silver 1 dot	·Silver 2 dots	—	—
Rubber hardness HS (±5°)	A50/S	Other than Heavy duty A40/S Heavy duty A50/S	A60/S	A60/S	A50/S	A50/S	A50/S	A50/S	20	15

● Color and Identification (ZP3)

General name	NBR (Nitrile rubber)	Silicone rubber	Urethane rubber	FKM (Fluororubber)	Conductive NBR (Nitrile rubber)	Conductive silicone rubber
Color of rubber	Black	White	Brown	Black	Black	Black
Identification (Dot)	—	—	—	·Green 1 dot	·Silver 1 dot	·Pink 1 dot
Rubber hardness HS (±5°)	A60/S					

Note) The hardness of rubber shall conform to JIS K 6253. The hardness of sponge shall conform to SRIS 0101.

● Buffer Attachment

- Choose buffer type when the workpieces are of varying heights, the workpieces are fragile, or you need to reduce the impact to the pad. If rotation needs to be limited, use non-rotating buffer.

Unsteady Distance between Pad and Workpiece

When the workpieces are of varying heights, use the buffer type pad with built-in spring. The spring creates a cushion effect between the pad and the workpieces. If rotation needs to be limited further, use non-rotating buffer type.

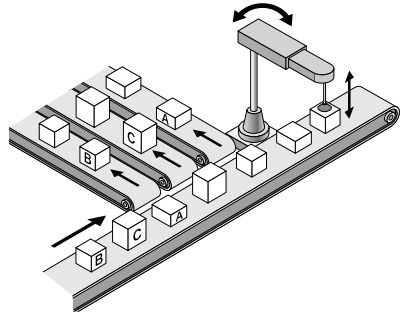
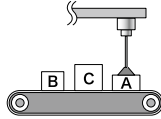

● Pad Selection by Workpiece Type

- Carefully select a pad for the following workpieces.

1. Porous Workpiece

To pick a permeable workpiece such as paper, select a pad with a small diameter that is sufficient to lift the workpiece. Because a large amount of air leakage could reduce the pad's suction force, it may be necessary to increase the capacity of an ejector or vacuum pump or enlarge the conductance area of the piping passage.

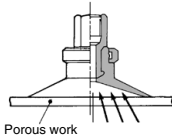

Porous work

2. Flat Plate Workpiece

When a workpiece with a large surface area such as sheet glass or PCB is suspended, the workpiece could move in a wavelike motion if a large force is applied by wind pressure or by an impact. Therefore, it is necessary to ensure the proper allocation and size of pads.

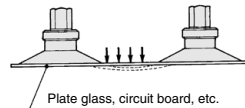
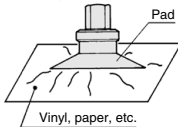

Plate glass, circuit board, etc.

3. Soft Workpiece

If a soft workpiece such as vinyl, paper, or thin sheet is picked up, the vacuum pressure could cause the workpiece to deform or wrinkle. In such a case, it will be necessary to use a small pad or a ribbed pad and reduce the vacuum pressure.



Vinyl, paper, etc.

4. Impact to Pad



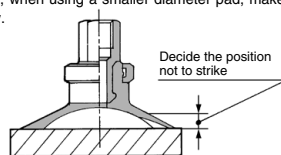

When pushing a pad to a workpiece, make sure not to apply an impact or a large force which would lead to premature deformation, cracking, or wearing of the pad. The pad should be pushed against the workpiece to the extent that its skirt portion deforms or that its ribbed portion comes into slight contact with the workpiece. Especially, when using a smaller diameter pad, make sure to locate it correctly.

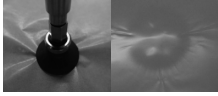

Model Selection

5. Adsorption Mark

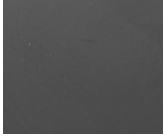
The main adsorption marks are as follows:

	Before suction	After suction	Countermeasure
<ul style="list-style-type: none"> ● Mark due to deformed (lined) workpiece 			1) Reduce the vacuum pressure. If lifting force is inadequate, increase the number of pads. 2) Select a pad with a smaller center area.
Suction conditions		Workpiece: Vinyl Vacuum pad: ZP20CS Vacuum pressure: -40 kPa	
<ul style="list-style-type: none"> ● Mark due to components contained in the rubber pad (material) moving to the workpiece. 			Use the following products. 1) Mark-free NBR pad 2) ZP2 series <ul style="list-style-type: none"> • Stuck fluororesin pad • Resin attachment
Suction conditions		Workpiece: Glass Vacuum pad: ZP20CS Vacuum pressure: -40 kPa	
<ul style="list-style-type: none"> ● A mark which remains on the rough surface of the workpiece due to wear-out of the rubber (pad material). 			Use the following products. 1) ZP2 series <ul style="list-style-type: none"> • Stuck fluororesin pad • Resin attachment
Suction conditions		Workpiece: Resin plate (Surface roughness 2.5 μ) Vacuum pad: ZP20CS Vacuum pressure: -80 kPa	

Vacuum Pad Durability

- Need to be careful of the vacuum pad (rubber) deterioration.
- When the vacuum pad is used continuously, the following problems may occur.
 - 1) Wear-out of the adsorption surface.
 - Shrinkage of the pad dimensions, sticking of the part where the rubber materials come into contact with each other (bellows pad)
 - 2) Weakening of the rubber parts (skirt of the adsorption surface, bending parts, etc.)
- * It may occur at an early stage depending on the operating conditions (high vacuum pressure, suction time [vacuum holding], etc.).
- Decide when to replace the pads, referring to the signs of deterioration, such as changes in the appearance due to wear, reduction in the vacuum pressure or delay in the transport cycle time.

3 Selection of Vacuum Ejector and Vacuum Switching Valve

● Calculating Vacuum Ejector and Switching Valve Size with the Formula

Average suction flow rate for achieving adsorption response time

$$Q = \frac{V \times 60}{T_1} + Q_L$$

$$T_2 = 3 \times T_1$$

Q : Average suction flow rate L/min (ANR)

V : Piping capacity (L)

T₁ : Arrival time to stable **P_v** 63% after adsorption (sec)

T₂ : Arrival time to stable **P_v** 95% after adsorption (sec)

Q_L : Leakage volume during workpiece adsorption L/min (ANR) ^{Note 1)}

Max. suction flow rate

$$Q_{max} = (2 \text{ to } 3) \times Q \text{ L/min (ANR)}$$

<Selection Procedure>

• **Ejector**

Select the ejector with the greater maximum suction flow rate from the **Q_{max}** indicated above.

• **Direct operation valve**

$$\text{Conductance } C = \frac{Q_{max}}{55.5} \text{ [dm}^3\text{/(s-bar)]}$$

* Select a valve (solenoid valve) having a conductance that is greater than that of the conductance **C** formula given above from the related equipment (page 793).

Note 1) **Q_L**: 0 when no leakage occurs during adsorbing a workpiece.

If there is leakage during adsorbing a workpiece, find the leakage volume based on "4. Leakage Volume during Workpiece Adsorption."

Note 2) Tube piping capacity can be found in "8. Data: Piping Capacity by Tube I.D. (Selection Graph (2))."

Note 3) When selecting a ZL series multistage ejector, these details do not apply. Refer to the "Time to Reach Vacuum" graph in the catalog for applicable details.

4 Leakage Volume during Workpiece Adsorption

Air could be drawn in depending on the type of workpiece. As a result, the vacuum pressure in the pad becomes reduced and the amount of vacuum that is necessary for adsorption cannot be attained.

When this type of workpiece must be handled, it is necessary to select the proper size of the ejector and the vacuum switching valve by taking into consideration the amount of air that could leak through the workpiece.

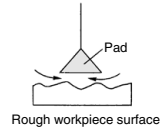
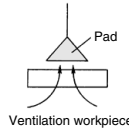

● Leakage Volume from Conductance of Workpiece

$$\text{Leakage volume } Q_L = 55.5 \times C_L$$

Q_L: Leakage volume L/min (ANR)

C_L: Conductance between workpiece and pad, and workpiece opening area [dm³/(s-bar)]

● Leakage Volume from Adsorption Test

As described in the illustration below, pick up the workpiece with the ejector, using an ejector, pad and a vacuum gauge.

At this time, read vacuum pressure **P₁**, obtain the suction flow rate from the flow rate characteristics graph for the ejector that is being used, and render this amount as the leakage of the workpiece.

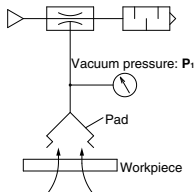

Exercise: Using a supply pressure of 0.45 MPa, when the ejector (ZH07□S) picks up a workpiece that leaks air, the vacuum gauge indicated a pressure of -53 kPa. Calculate the leakage volume from the workpiece.

<Selection Procedure>

When obtaining the suction flow rate at a vacuum pressure of -53 kPa from the ZH07DS flow rate characteristics graph, the suction flow rate is 5 L/min (ANR). (A→B→C)

$$\text{Leakage volume} = \text{Suction flow rate } 5 \text{ L/min (ANR)}$$

ZH07BS, ZH07DS

Exhaust Characteristics

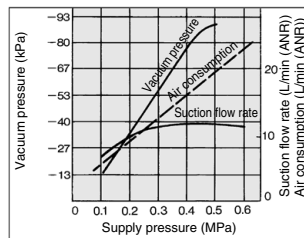

Flow rate Characteristics

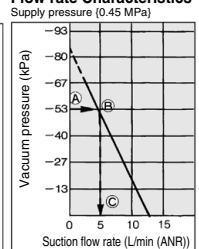

Model Selection

5 Adsorption Response Time

When a vacuum pad is used for the adsorption transfer of a workpiece, the approximate adsorption response time can be obtained (the length of time it takes for the pad's internal vacuum pressure to reach the pressure that is required for adsorption after the supply valve (vacuum switching valve) has been operated). An approximate adsorption response time can be obtained through formulas and selection graphs.

However, when selecting a ZL series multistage ejector, these details do not apply. Refer to the "Time to Reach Vacuum" graph in the catalog for applicable details.

● Relationship between Vacuum Pressure and Response Time after Supply Valve (Switching Valve) is Operated

The relationship between vacuum pressure and response time after the supply valve (switching valve) is operated as shown below.

Vacuum System Circuit

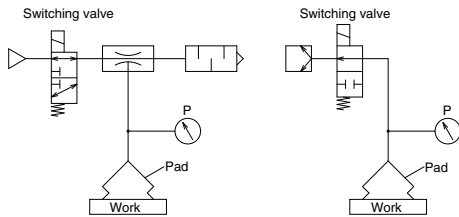

Vacuum Pressure and Response Time after Supply Valve (Switching Valve) is Operated

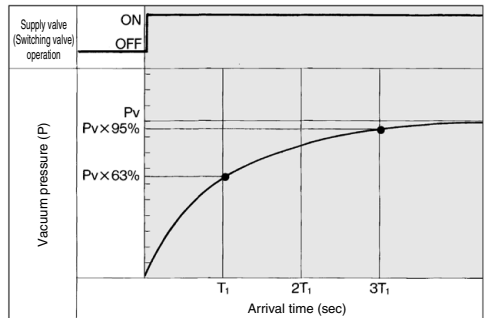

Pv: Final vacuum pressure
T₁: Arrival time to 63% of final vacuum pressure **Pv**
T₂: Arrival time to 95% of final vacuum pressure **Pv**

● Calculating Adsorption Response Time with the Formula

Adsorption response times **T₁** and **T₂** can be obtained through the formulas given below.

$$\text{Adsorption response time } T_1 = \frac{V \times 60}{Q}$$

$$\text{Adsorption response time } T_2 = 3 \times T_1$$

Piping capacity

$$V = \frac{3.14}{4} D^2 \times L \times \frac{1}{1000} \text{ (L)}$$

T₁: Arrival time to 63% of final vacuum pressure **Pv** (sec)

T₂: Arrival time to 95% of final vacuum pressure **Pv** (sec)

Q₁: Average suction flow rate L/min [ANR]

Calculation of average suction flow rate

• Ejector

$$Q_1 = (1/2 \text{ to } 1/3) \times \text{Ejector max. suction flow rate L/min [ANR]}$$

• Vacuum pump

$$Q_1 = (1/2 \text{ to } 1/3) \times 55.5 \times \text{Conductance of vacuum pump [dm}^3\text{/(s-bar)]}$$

D: Piping diameter (mm)

L: Length from ejector and switch valve to pad (m)

V: Piping capacity from ejector and switching valve to pad (L)

Q₂: Max. flow from ejector and switching valve to pad by piping system

$$Q_2 = C \times 55.5 \text{ L/min [ANR]}$$

Q: Smaller one between the **Q₁** and **Q₂** L/min [ANR]

C: Conductance of piping [dm³/(s-bar)]

For the conductance, the equivalent conductance can be found in "8. Data: Conductance by Tube I.D. (Selection Graph (3))."

● Adsorption Response Time from the Selection Graph

1. Tube Piping Capacity

Piping capacity from the ejector and switching valve at vacuum pump to the pad can be found in "8. Data: Piping Capacity by Tube I.D. (Selection Graph (2))."

2. Obtain the adsorption response times.

By operating the supply valve (switching valve) that controls the ejector (vacuum pump), the adsorption response times T_1 and T_2 that elapsed before the prescribed vacuum pressure is reached can be obtained from the Selection Graph (1).

Selection Graph (1) Adsorption Response Time

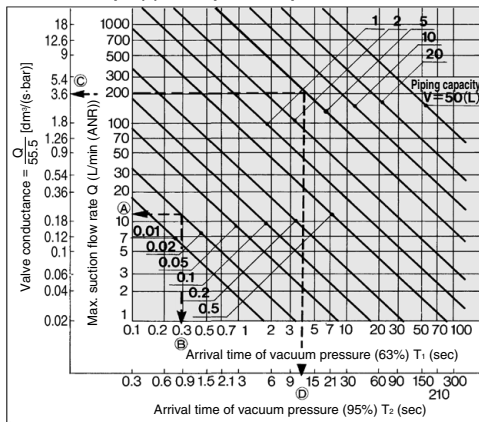

* Conversely, the size of the ejector or the size of the switching valve of the vacuum pump system can be obtained from the adsorption response time.

How to read the graph

Example 1: For obtaining the adsorption response time until the pressure in the piping system with a piping capacity of 0.02 L is discharged to 63% (T_1) of the final vacuum pressure through the use of the vacuum ejector ZH07□S with a maximum suction flow rate of 12 L/min (ANR).

<Selection Procedure>

From the point at which the vacuum ejector's maximum vacuum suction flow rate of 12 L/min (ANR) and the piping capacity of 0.02 L intersect, the adsorption response time T_1 that elapses until 63% of the maximum vacuum pressure is reached can be obtained. (Sequence in Selection Graph (1), (A)→(B)) $T_1 = 0.3$ seconds.

Example 2: For obtaining the discharge response time until the internal pressure in the 5 L tank is discharged to 95% (T_2) of the final vacuum pressure through the use of a valve with a conductance of 3.6 [dm³/(s·bar)].

<Selection Procedure>

From the point at which the valve's conductance of 3.6 [dm³/(s·bar)] and the piping capacity of 5 L intersect, the discharge response time (T_2) that elapses until 95% of the final vacuum pressure is reached can be obtained. (Sequence in Selection Graph (1), (C)→(D)) $T_2 \approx 12$ seconds.

Model Selection

6 Precautions on Vacuum Equipment Selection and SMC's Proposal

● Safety Measures

- Make sure to provide a safe design for a vacuum pressure drop due to a disruption of power supply, or a lack of supply air. Drop prevention measures must be taken in particular when dropping a workpiece presents some degree of danger.

● Precautions on Vacuum Equipment Selection

As a countermeasure for power outages, select a supply valve that is normally open or one that is equipped with a self-holding function.

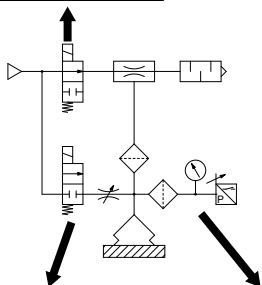

Be aware that the composite conductance consisting of the areas from the pad to the ejector of a vacuum switching valve does not decrease.

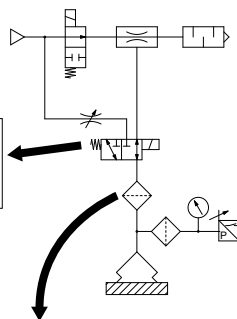

For the release valve, select a 2/3 port valve with a low vacuum specification. Also, use a needle valve to regulate the release flow rate.

- During the adsorption and transfer of a workpiece, verification of the vacuum switch is recommended.
- In addition, visually verify the vacuum gauge when handling a heavy or a hazardous item.
- Install a filter (ZFA, ZFB, ZFC series) before the pressure switch if the ambient air is of low quality.

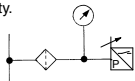

Use a suction filter (ZFA, ZFB, ZFC series) to protect the switching valve and to prevent the ejector from becoming clogged. Also, a suction filter must be used in a dusty environment. If only the unit's filter is used, it will become clogged quickly.

● Vacuum Ejector or Pump and Number of Vacuum Pads

Ejector and number of pads		Vacuum pump and number of pads	
Ideally, one pad should be used for each ejector.	When more than one pad is attached to a single ejector, if one of the workpieces becomes detached, the vacuum pressure will drop, causing other workpieces to become detached. Therefore, the countermeasures listed below must be taken. <ul style="list-style-type: none"> • Adjust the needle valve to minimize the pressure fluctuation between adsorption and non-adsorption operations. • Provide a vacuum switching valve to each individual pad to minimize the influences on other pads if an adsorption error occurs. 	Ideally, one pad should be used for each line.	When more than one pad is attached to a single vacuum line, take the countermeasures listed below. <ul style="list-style-type: none"> • Adjust the needle valve to minimize the pressure fluctuation between adsorption and non-adsorption operation. • Include a tank and a vacuum pressure reduction valve (vacuum pressure regulator valve) to stabilize the source pressure. • Provide a vacuum switching valve to each individual pad to minimize the influences on other pads if an adsorption error occurs.

● Vacuum Ejector Selection and Handling Precautions

Ejector Selection

There are 2 types of ejector flow rate characteristics: the high vacuum type (S type) and the high flow type (L type). During the selection, pay particular attention to the vacuum pressure when adsorbing workpieces that leak.

High Vacuum Type Flow Rate Characteristics/ ZH13□S

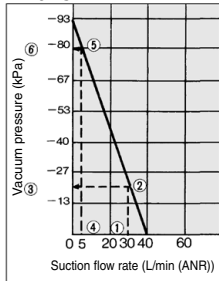

High Flow Type Flow Rate Characteristics/ ZH13□L

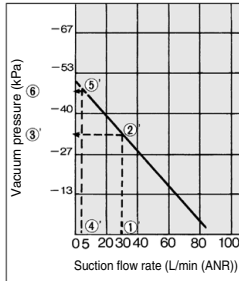

The vacuum pressure varies in accordance with the leakage volumes indicated in the above diagrams.

If the leakage volume is 30 L/min (ANR), the vacuum pressure of the S type is -20 kPa ① → ② → ③, and for the L type it is -33 kPa ①' → ②' → ③'. If the leakage volume is 5 L/min (ANR), the vacuum pressure of the S type is -80 kPa ④ → ⑤ → ⑥, and for the L type it is -47 kPa ④' → ⑤' → ⑥'. Thus, if the leakage volume is 30 L/min (ANR) the L type can attain a higher vacuum pressure, and if the leakage volume is 5 L/min (ANR), the S type can attain a higher vacuum pressure.

Thus, during the selection process, make sure to take the flow rate characteristics of the high vacuum type (S type) and the high flow type (L type) into consideration in order to select the type that is optimal for your application.

- If the vacuum ejector makes an intermittent noise (abnormal noise) from exhaust at a certain supply pressure, the vacuum pressure will not be stable. It will not be any problem if the vacuum ejector is used under this condition. However, if the noise is disturbing or might affect the operation of the vacuum pressure switch, lower or raise supply pressure a little at a time, and use in an air pressure range that does not produce the intermittent noise.

● Supply Pressure of Vacuum Ejector

- It is recommended to use the vacuum ejector at the standard supply pressure. The maximum vacuum pressure and suction flow rate can be obtained when the vacuum ejector is used at the standard supply pressure, and as a result, adsorption response time also improves. From the viewpoint of energy-saving, it is the most effective to use the ejector at the standard supply pressure. Since using it at an excessive supply pressure may cause the ejector performance to lower, it is recommended to use at the standard supply pressure.

Ejector Nozzle Diameter Selection

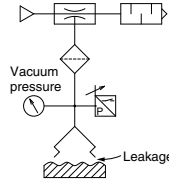

If a considerable amount of leakage occurs between the workpiece and the pad, resulting in incomplete adsorption, or to shorten the adsorption and transfer time, select an ejector nozzle with a larger diameter from the ZH, ZR, or ZL series.

Manifold Use

Individual exhaust

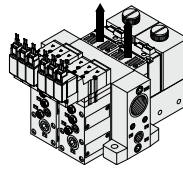

Centralized exhaust

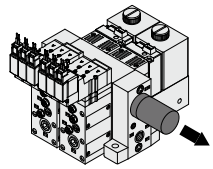

If there are a large number of ejectors that are linked on a manifold and operate simultaneously, use the built-in silencer type or the port exhaust type.

If there are a large number of ejectors that are linked on a manifold, which exhaust collectively, install a silencer at both ends. If the exhaust must be discharged outdoors through piping, make the diameter of the piping larger to control its back pressure to 5 kPa or less so that the back pressure will not affect the operation of the ejectors.

Model Selection

● Timing for Vacuum Generation and Suction Verification

A. Timing for Vacuum Generation

The time for opening/closing the valve will be counted if a vacuum is generated after the adsorption pad descends to adsorb a workpiece. Also, there is a timing delay risk for the generating vacuum since the operational pattern for the verification switch, which is used for detecting the descending vacuum pad, is not even.

To solve this issue, we recommend that vacuum be generated in advance, before the vacuum pad begins to descend to the workpiece. Adopt this method after confirming that there will be no misalignment resulting from the workpiece's light mass.

B. Suction Verification

When lifting the vacuum pad after absorbing a workpiece, confirm that there is a suction verification signal from the vacuum pressure switch, before the vacuum pad is lifted. If the vacuum pad is lifted, based on the timing of a timer, etc., there is a risk that the workpiece may be left behind.

In general adsorption transfer, the time for adsorbing a workpiece is slightly different since the position of the vacuum pad and the workpiece are different after every operation. Therefore, program a sequence in which the suction completion is verified by a vacuum pressure switch, etc. before moving to the next operation.

C. Set Pressure for Vacuum Pressure Switch

Set the optimum value after calculating the required vacuum pressure for lifting a workpiece.

If a higher pressure than required is set, there is a possibility of being unable to confirm the suction even though the workpiece is adsorbed. This will result in a suction error.

When setting vacuum pressure switch set values, you should set using a lower pressure, with which a workpiece can be adsorbed, only after considering the acceleration or vibration when a workpiece is transferred. The set value of the vacuum pressure switch shortens the time to lift a workpiece. Since the switch detects whether the workpiece is lifted or not, the pressure must be set high enough to detect it.

Vacuum Pressure Switch (ZSE Series), Flow Sensor (PFMV Series), Vacuum Pressure Gauge (GZ Series)

When adsorbing and transferring a workpiece, verify at the vacuum pressure switch as much as possible (In addition, visually verify the vacuum gauge, especially when handling a heavy or a hazardous item.).

Approx. $\phi 1$ adsorption nozzle

The difference in pressure between ON and OFF becomes small depending on the capacity of the ejector and vacuum pump. In such a case, it is necessary to use the digital pressure switch ZSE10 or ZSE30A with a fine smallest settable increment or a flow switch for flow rate detection.

Note) • A vacuum generator with a large suction capacity will not be detected properly, so an ejector with an appropriate capacity must be selected.

- Since the hysteresis is small, vacuum pressure must be stabilized.



Vacuum pressure switch
ZSE10, ZSE30A



Flow sensor
PFMV



Vacuum pressure
gauge
GZ46

Timing Chart Example

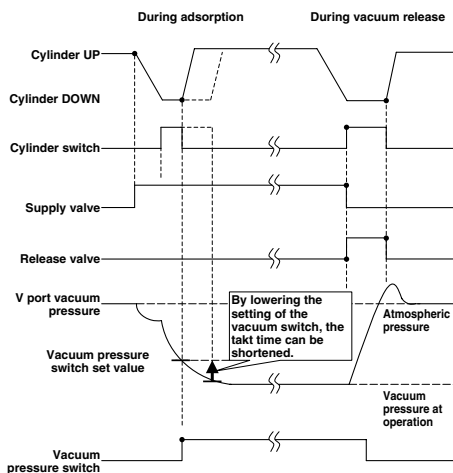

Refer to the Best Pneumatics No. 8 for details.

● Dust Handling of Vacuum Equipment

- When the vacuum equipment is used, not only the workpiece, but also dust in the surrounding environment is taken in the equipment. Preventing the intrusion of dust is required more than for any other pneumatic equipment. Some of SMC's vacuum equipment comes with a filter, but when there is a large amount of dust, an additional filter must be installed.
- When vaporized materials such as oil or adhesive are sucked into the equipment, they accumulate inside, which may cause problems.
- It is important to prevent dust from entering the vacuum equipment as much as possible.
 - (1) Make sure to keep the working environment and surrounding area of the workpiece clean so that dust will not be sucked in the equipment.
 - (2) Check the amount and types of dust before using the equipment and install a filter, etc., in the piping when necessary.
 - (3) Conduct a test and make sure that operating conditions are cleared before using the equipment.
 - (4) Perform filter maintenance depending on the amount of dirt.
 - (5) Filter clogging generates a pressure difference between the adsorption and ejector parts. This requires attention, since clogging can prevent proper adsorption from being achieved.

Air Suction Filter (ZFA, ZFB, ZFC Series)

- To protect the switching valve and the ejector from becoming clogged, a suction filter in the vacuum circuit is recommended.
- When using an ejector in a dusty environment, the unit's filter will become clogged quickly, so it is recommended that the ZFA, ZFB or ZFC series be used concurrently.

Vacuum Line Equipment Selection

Determine the volume of the suction filter and the conductance of the switching valve in accordance with the maximum suction flow rate of the ejector and the vacuum pump. Make sure that the conductance is greater than the value that has been obtained through the formula given below. (If the devices are connected in series in the vacuum line, their conductances must be combined.)

$$C = \frac{Q_{\max}}{55.5}$$

C: Conductance [dm³/(s·bar)]
Q_{max}: Max. suction flow rate L/min (ANR)

Model Selection

7 Vacuum Equipment Selection Example

● Transfer of Semiconductor Chips

Selection conditions:

- (1) Workpiece: Semiconductor chips
Dimensions: 8 mm x 8 mm x 1 mm, Mass: 1 g
- (2) Vacuum piping length: 1 m
- (3) Adsorption response time: 300 msec or less

1. Vacuum Pad Selection

- (1) Based on the workpiece size, the pad diameter is 4 mm (1 pc.).
- (2) Using the formula on page 28, confirm the lifting force.

$$\begin{aligned} W &= P \times S \times 0.1 \times 1/t \\ 0.0098 &= P \times 0.13 \times 0.1 \times 1/4 \\ P &= 3.0 \text{ kPa} \end{aligned} \quad \left\{ \begin{array}{l} W = 1 \text{ g} = 0.0098 \text{ N} \\ S = \pi/4 \times (0.4)^2 = 0.13 \text{ cm}^2 \\ t = 4 \text{ (Horizontal lifting)} \end{array} \right.$$

According to the calculation, -3.0 kPa or more of vacuum pressure can adsorb the workpiece.

- (3) Based on the workpiece shape and type, select:
Pad type: Flat with groove
Pad material: Silicone rubber
- (4) According to the results above, select a vacuum pad part number ZP3-04UMS.

2. Vacuum Ejector Selection

- (1) Find the vacuum piping capacity.
Assuming that the tube I.D. is 2 mm, the piping capacity is as follows:
$$V = \pi/4 \times D^2 \times L \times 1/1000 = \pi/4 \times 2^2 \times 1 \times 1/1000 = 0.0031 \text{ L}$$
- (2) Assuming that leakage (Q_L) during adsorption is 0, find the average suction flow rate to meet the adsorption response time using the formula on page 33.

$$Q = (V \times 60) / T_1 + Q_L = (0.0031 \times 60) / 0.3 + 0 = 0.62 \text{ L}$$

From the formula on page 33, the maximum suction flow rate Q_{\max} is

$$\begin{aligned} Q_{\max} &= (2 \text{ to } 3) \times Q = (2 \text{ to } 3) \times 0.62 \\ &= 1.24 \text{ to } 1.86 \text{ L/min (ANR)} \end{aligned}$$

According to the maximum suction flow rate of the vacuum ejector, a nozzle with a 0.5 diameter can be used. If the vacuum ejector ZX series is used, representative model ZX105□ can be selected. (Based on the operating conditions, specify the complete part number for the vacuum ejector used.)

3. Adsorption Response Time Confirmation

Confirm the adsorption response time based on the characteristics of the vacuum ejector selected.

- (1) The maximum suction flow rate of the vacuum ejector ZX105□ is 5 L/min (ANR). From the formula on page 34, the average suction flow rate Q_1 is as follows:

$$\begin{aligned} Q_1 &= (1/2 \text{ to } 1/3) \times \text{Ejector max. suction flow rate} \\ &= (1/2 \text{ to } 1/3) \times 5 = 2.5 \text{ to } 1.7 \text{ L/min (ANR)} \end{aligned}$$

- (2) Next, find the maximum flow rate Q_2 of the piping. The conductance C is 0.22 from the Selection Graph (3). From the formula on page 34, the maximum flow rate is as follows:

$$Q_2 = C \times 55.5 = 0.22 \times 55.5 = 12.2 \text{ L/min (ANR)}$$

- (3) Since Q_2 is smaller than Q_1 , $Q = Q_1$.

Thus, from the formula on page 34, the adsorption response time is as follows:

$$\begin{aligned} T &= (V \times 60) / Q = (0.0031 \times 60) / 1.7 = 0.109 \text{ seconds} \\ &= 109 \text{ msec} \end{aligned}$$

It is possible to confirm that the calculation result satisfies the required specification of 300 msec.

8 Data

● Selection Graph

Selection Graph (2) Piping Capacity by Tube I.D.

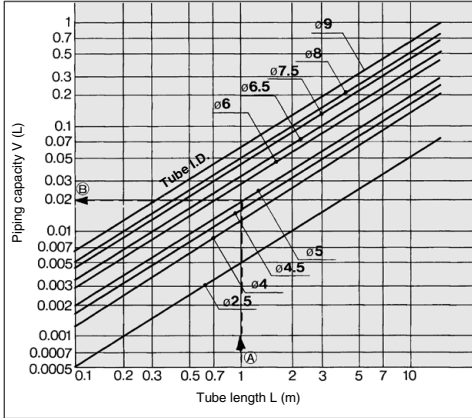

How to read the graph

Example: For obtaining the capacity of tube I.D. ø5 and 1 meter length

<Selection Procedure>

By extending leftward from the point at which the 1 meter tube length on the horizontal axis intersects the line for a tube I.D. ø5, the piping capacity approximately equivalent to 0.02 L can be obtained on the vertical axis.

Piping capacity = 0.02 L

Selection Graph (3) Conductance by Tube I.D.

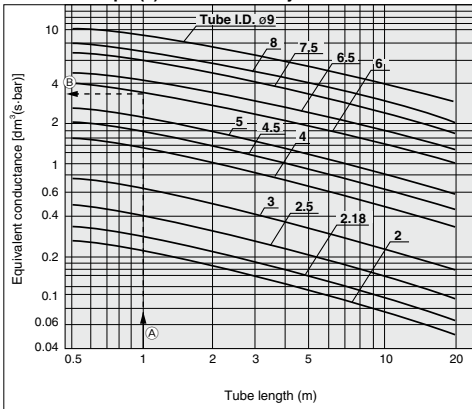

How to read the graph

Example: Tube size ø8/ø6 and 1 meter length

<Selection Procedure>

By extending leftward from the point at which the 1 meter tube length on the horizontal axis intersects the line for a tube I.D. ø6, the equivalent conductance approximately 3.6 [dm²/(s-bar)] can be obtained on the vertical axis.

Equivalent conductance = 3.6 [dm²/(s-bar)]

Model Selection

● Glossary of Terms

Terms	Description
(Max.) suction flow rate	Volume of air taken in by the ejector. The maximum value is the volume of air taken in without having anything connected to the vacuum port.
Maximum vacuum pressure	The maximum value of the vacuum pressure generated by the ejector
Air consumption	The compressed volume of air consumed by the ejector
Standard supply pressure	The optimal supply pressure for operating the ejector
Exhaust characteristics	The relationship between the vacuum pressure and the suction flow rate when the supply pressure to the ejector has been changed.
Flow rate characteristics	The relationship between the vacuum pressure and the suction flow rate with the standard supply pressure supplied to the ejector.
Vacuum pressure switch	Pressure switch for verifying the adsorption of a workpiece
(Air) supply valve	Valve for supplying compressed air to the ejector
(Vacuum) release valve	Valve for supplying positive pressure or air for breaking the vacuum state of the adsorption pad
Flow adjustment valve	Valve for adjusting the volume of air for breaking the vacuum
Pilot pressure	Pressure for operating the ejector valve
External release	The action of breaking the vacuum using externally supplied air instead of using the ejector unit
Vacuum port	Port for generating vacuum
Exhaust port	Port for exhausting air consumed by the ejector, and air taken in from the vacuum port.
Supply port	Port for supplying air to the ejector
Back pressure	Pressure inside the exhaust port
Leakage	The entry of air into the vacuum passage, such as from an area between a workpiece and a pad, or between a fitting and a tube. The vacuum pressure decreases when leakage occurs.
Response time	The time from the application of the rated voltage to the supply valve or release valve, until V port pressure reaches the specified pressure.
Average suction flow rate	The suction flow rate by the ejector or pump for calculating the response speed. It is 1/2 to 1/3 of the maximum suction flow rate.
Conductive pad	A low electrical resistance pad for electrostatic prevention measure
Vacuum pressure	Any pressure below the atmospheric pressure. When the atmospheric pressure is used as a reference, the pressure is presented by -kPa (G), and when the absolute pressure is used as a reference, the pressure is represented by kPa (abs). When referencing a piece of vacuum equipment such as an ejector, the pressure is generally represented by -kPa.
Ejector	A unit for generating vacuum by discharging the compressed air from a nozzle at a high speed, based on the phenomenon in which the pressure is reduced when the air around the nozzle is sucked.
Air suction filter	Vacuum filter provided in the vacuum passage for preventing the dust intrusion into the ejector, vacuum pump, or peripheral equipment

● Countermeasures for Vacuum Adsorption System Problems (Troubleshooting)

Condition & Description of improvement	Contributing factor	Countermeasure
Initial adsorption problem (During trial operation)	Adsorption area is small. (Lifting force is lower than the workpiece mass.)	Recheck the relationship between workpiece mass and lifting force. • Use a vacuum pad with a large adsorption area. • Increase the quantity of vacuum pads.
	Vacuum pressure is low. (Leakage from adsorption surface) (Air permeable workpiece)	Eliminate (reduce) leakage from adsorption surface. • Reconsider the shape of a vacuum pad. Check the relationship between suction flow rate and arrival pressure of vacuum ejector. • Use a vacuum ejector with a high suction flow rate. • Increase adsorption area.
	Vacuum pressure is low. (Leakage from vacuum piping)	Repair leakage point.
	Internal volume of vacuum circuit is large.	Check the relationship between internal volume of the vacuum circuit and suction flow rate of the vacuum ejector. • Reduce internal volume of the vacuum circuit. • Use a vacuum ejector with a high suction flow rate.
	Pressure drop of vacuum piping is large.	Reconsider vacuum piping. • Use a shorter or larger tube (with appropriate diameter).
	Inadequate supply pressure of vacuum ejector	Measure supply pressure in vacuum generation state. • Use standard supply pressure. • Reconsider compressed air circuit (line).
	Clogging of nozzle or diffuser (Infiltration of foreign matter during piping)	Remove foreign matter.
	Supply valve (switching valve) is not being activated.	Measure supply voltage at the solenoid valve with a tester. • Reconsider electric circuits, wiring and connectors. • Use in the rated voltage range.
	Workpiece deforms during adsorption.	Since a workpiece is thin, it deforms and leakage occurs. • Use a pad for adsorption of thin objects.
Late vacuum achieving time (Shortening of response time)	Internal volume of vacuum circuit is large.	Check the relationship between internal volume of the vacuum circuit and suction flow rate of the vacuum ejector. • Reduce internal volume of the vacuum circuit. • Use a vacuum ejector with a high suction flow rate.
	Pressure drop of vacuum piping is large.	Reconsider vacuum piping. • Use a shorter or larger tube (with appropriate diameter).
	Using the product as close to the highest vacuum power in the specifications.	Set vacuum pressure to minimum necessary value by optimizing the pad diameter etc. As the vacuum power of an ejector (venturi) rises, the vacuum flow actually lowers. When an ejector is used at its highest possible vacuum value, the vacuum flow will lower. Due to this, the amount of time needed to achieve adsorption is lengthened. One should consider an increase in the diameter of the ejector nozzle or an increase the size of the vacuum pad utilized in order to lower the required vacuum pressure, maximum the vacuum flow, and speed up the adsorption process.
	Setting of vacuum pressure switch is too high.	Set to suitable setting pressure.
Fluctuation in vacuum pressure	Fluctuation in supply pressure	Reconsider compressed air circuit (line). (Addition of a tank etc.)
	Vacuum pressure may fluctuate under certain conditions due to ejector characteristics.	Lower or raise supply pressure a little at a time, and use in a supply pressure range where vacuum pressure does not fluctuate.
Occurrence of abnormal noise (intermittent noise) from exhaust of vacuum ejector	Intermittent noise may occur under certain conditions due to ejector characteristics.	Lower or raise supply pressure a little at a time, and use in a supply pressure range where the intermittent noise does not occur.
Air leakage from vacuum port of manifold type vacuum ejector	Exhaust air from the ejector enters the vacuum port of another ejector that is stopped.	Use a vacuum ejector with a check valve. (Please contact SMC for the part number of an ejector with a check valve.)

Model Selection

Condition & Description of improvement	Contributing factor	Countermeasure
Adsorption problem over time (Adsorption is normal during trial operation.)	Clogging of suction filter	Replace filters. Improve installation environment.
	Clogging of sound absorbing material	Replace sound absorbing materials. Add a filter to supply (compressed) air circuit. Install an additional suction filter.
	Clogging of nozzle or diffuser	Remove foreign matter. Add a filter to supply (compressed) air circuit. Install an additional suction filter.
	Vacuum pad (rubber) deterioration, cracking, etc.	Replace vacuum pads. Check the compatibility of vacuum pad material and workpiece.
Workpiece is not released.	Inadequate release flow rate	Open release flow adjustment needle.
	Vacuum pressure is high. Excessive force (adhesiveness of the rubber + vacuum pressure) is applied to the pad (rubber part).	Reduce the vacuum pressure. If inadequate lifting force causes a problem in transferring the workpieces, increase the number of pads.
	Effects due to static electricity	Use a conductive pad.
	Adhesiveness of the rubber increases due to the operating environment or wearing of the pad. <ul style="list-style-type: none"> • Adhesiveness of the rubber material is high. • Adhesiveness increases due to wearing of the vacuum pad (rubber). 	Replace pads. Reconsider the pad material and check the compatibility of pad material and workpiece. Reconsider the pad form. (Changes to rib, groove, blast options) Reconsider the pad diameter and quantity of pads.

● Non-conformance Examples

Phenomenon	Possible causes	Countermeasure
No problem occurs during the test, but adsorption becomes unstable after starting operation.	<ul style="list-style-type: none"> Setting of the vacuum switch is not appropriate. Supply pressure is unstable. Vacuum pressure does not reach the set pressure. There is leakage between the workpiece and the vacuum pad. 	<ol style="list-style-type: none"> Set the pressure for the vacuum equipment (supply pressure, if using an ejector) to the necessary vacuum pressure during the adsorption of the workpieces. And set the set pressure for the vacuum switch to the necessary vacuum pressure for adsorption. It is presumed that there was leakage during the test, but it was not serious enough to prevent adsorption. Reconsider the vacuum ejector and the shape, diameter, and material of the vacuum pad. Reconsider the vacuum pad.
Adsorption becomes unstable after replacing the pad.	<ul style="list-style-type: none"> Initial setting conditions (vacuum pressure, vacuum switch setting, height of the pad) have changed. Settings have changed because the pad was worn out or had permanent setting due to the operating environment. When the pad was replaced, leakage was generated from the screw connection part, or the engagement between the pad and the adapter. 	<ol style="list-style-type: none"> Reconsider the operating conditions including vacuum pressure, the set pressure of the vacuum switch, and the height of the pad. Reconsider the engagement.
Identical pads are used to adsorb identical workpieces, but some of the pads cannot adsorb the workpieces.	<ul style="list-style-type: none"> There is leakage between the workpiece and the vacuum pad. The supply circuit for the cylinder, the solenoid valve and the ejector is in the same pneumatic circuit system. The supply pressure decreases when they are used simultaneously. (Vacuum pressure does not increase.) There is leakage from the screw connection part or the engagement between the pad and the adapter. 	<ol style="list-style-type: none"> Reconsider the pad diameter, shape, material, vacuum ejector (suction flow rate), etc. Reconsider the pneumatic circuit. Reconsider the engagement.
Generation of sticking of bellows of the bellows pad and/or recovery delays. (It may occur at an early stage.)	When the vacuum pad (bellows type) reaches the end of its life, weakening of bent parts, wearing, or sticking of rubber parts occurs.	The operating conditions will determine the product life. Inspect it sufficiently and determine the replacement time. <ul style="list-style-type: none"> Replace pads. Reconsider the diameter, form, and material of vacuum pads. Reconsider the quantity of vacuum pads.
	Vacuum pressure is higher than necessary, so excessive force (adhesiveness of the rubber + vacuum pressure) is applied to the pad (rubber part).	Reduce the vacuum pressure. If inadequate lifting force causes a problem in transferring the workpieces due to the reduction of vacuum pressure, increase the number of pads.
	Load is applied to the bellows due to the following operations, leading to sticking of rubber parts or reduction of the pad recovery performance. <ul style="list-style-type: none"> Pushing exceeding pad displacement (operating range), external load. Workpiece holding/waiting Waiting 10 seconds or more while the workpiece is being held <ul style="list-style-type: none"> Even when under 10 seconds, pads sticking or a recovery delay issues may occur earlier depending on the operating environment and operating method. Longer workpiece holding times lead to longer recovery times and a shorter life.	Reduce the load applied to the pad. <ul style="list-style-type: none"> Review the equipment so that an external load exceeding the pad displacement (operating range) is not applied. Avoid workpiece holding and waiting. The operating conditions will determine the product life. Inspect it and determine the replacement time.
The product life is shortened after replacement of the product (pad, buffer, etc.).	<ul style="list-style-type: none"> The settings of the product changed. Tube had been pulled. Unbalanced load in clockwise direction increased. The transfer speed increased. The workpiece to be transferred was changed. (Shape, center of gravity, weight, etc.) The mounting orientation was at an angle. The operating environment changed. The buffer (mounting nut) was not tightened with the appropriate torque. 	If the problem (cannot adsorb) does not occur when starting operation, the product may reach the end of its life due to the customer's specification conditions. Reconsider the piping and operation (specifications). The selected model may not be appropriate for the current workpiece to be transferred or the specifications. Select the product model again by reconsidering the pad shape, diameter, quantity, and suction balance.
Pad comes out from the adapter during operation. Cracks are generated on the pad.	<ul style="list-style-type: none"> Load is applied to the pad (rubber part) due to the following factors. Inadequate lifting force Incorrect suction balance Loads due to transfer acceleration are not considered when selecting the product model. 	The selected model may not be appropriate for the current workpiece to be transferred or the specifications. Select the product model again by reconsidering the pad shape, diameter, quantity, and suction balance.

Model Selection

Phenomenon	Possible causes	Countermeasure
<p>Cracks are generated on the rubber (NBR, conductive NBR).</p> 	<ul style="list-style-type: none"> • The product is operated in an ozone environment. • An ionizer is used. * This phenomenon occurs earlier if pushing or the high vacuum pressure is used. 	<p>Reconsider the operating environment. Reconsider the materials to be used.</p>
<p>Even when a mark-free pad is used, the pad end wears out quickly. (Suction marks are generated.)</p>	<p>If the pad adsorbs a highly clean workpiece, slippage is minimized, and a load (impact) is applied to the pad end.</p>	<p>Use the following products.</p> <ul style="list-style-type: none"> • Stuck fluororesin pad • Clean attachment
<p>Even when a mark-free pad is used, suction marks are generated.</p>	<ul style="list-style-type: none"> • Incorrect application (The mark was generated due to a deformation.) • Contamination (insufficient cleaning) on the pad when installing the equipment, dust in the operating environment etc. 	<p>Check the mark generated on the workpiece.</p> <ol style="list-style-type: none"> 1) Mark due to deformed (lined) workpiece Reconsider the pad diameter, form, material, vacuum ejector (suction flow rate), etc. 2) Mark due to worn rubber Reconsider the pad diameter, form, material, vacuum ejector (suction flow rate), etc. 3) Mark generated by moving components If the suction mark disappears or becomes smaller after wiping with cloth or waste cloth (without using solutions), clean the pad as it may have been contaminated. Refer to "Cleaning method (Mark-free NBR pad)" on page 559 of this catalog.

■ When mounted with the nut, sometimes the buffer operation is not smooth, or the buffer does not slide.

[Possible causes]

- The tightening torque of the nut for mounting the buffer is too high.
- Particles stuck to the sliding surface, or it is scratched.
- Lateral load applied to the piston rod, causing eccentric wearing.

[Remedy]

Tighten the nut to the recommended tightening torque.

The nut may become loose depending on the operating conditions and environment. Be sure to perform regular maintenance.

ZP/ZP2

Pad diameter	Product specifications		Nut tightening torque
	Product part no.	Mounting thread size	
ø2 to ø16 2004 to 4010	ZP□ (02 to 08) U, B□ ZP□ (10 to 16) UT, C□ ZP□ (2004 to 4010) U□	M8 x 1	1.5 to 2.0 N·m
ø10 to ø32	ZP□ (10 to 32) U, C, B, D□ ZP□ (10 to 16) F□	M10 x 1	2.5 to 3.5 N·m
ø20 to ø50	ZP□ (40, 50) U, C, B, D□ ZP□ (20 to 50) F□	M14 x 1	6.5 to 7.5 N·m

ZP3

Pad diameter	Product specifications		Nut tightening torque
	Product part no.	Mounting thread size	
ø1.5 to ø3.5	ZP3-*(015 to 035) U*	M6 x 0.75	1.5 to 1.8 N·m
		M8 x 0.75	2.0 to 2.5 N·m
ø4 to ø16	ZP3-*(04 to 16) UM,B* ZP3-*(10 to 16) UM,B*	M8 x 0.75	2.0 to 2.5 N·m

Heavy-duty Pad

Pad diameter	Product specifications			Nut tightening torque
	Product part no.	Mounting thread size	Buffer body material	
ø40, ø50	ZP□ (40/50) H□ ZP□ (40/50) HB□	M18 x 1.5	Aluminum alloy	9.5 to 10.5 N·m
			Brass	28 to 32 N·m
			Steel	48 to 52 N·m
ø63, ø80	ZP□ (63/80) H□ ZP□ (63/80) HB□	M18 x 1.5	Aluminum alloy	9.5 to 10.5 N·m
			Brass	28 to 32 N·m
			Steel	48 to 52 N·m
ø100, ø125	ZP□ (100/125) H□ ZP□ (100/125) HB□	M22 x 1.5	Aluminum alloy	9.5 to 10.5 N·m
			Brass	45 to 50 N·m
			Steel	75 to 80 N·m

Heavy-duty Ball Joint Pad

Pad diameter	Product specifications			Nut tightening torque
	Product part no.	Mounting thread size	Buffer body material	
ø40, ø50	ZP2-□F (40/50) H□ ZP2-□F (40/50) HB□	M18 x 1.5	Brass	28 to 32 N·m
			Steel	48 to 52 N·m
ø63, ø80	ZP2-□F (63/80) H□ ZP2-□F (63/80) HB□	M22 x 1.5	Brass	45 to 50 N·m
			Steel	75 to 80 N·m
ø100, ø125	ZP2-□F (100/125) H□ ZP2-□F (100/125) HB□	M22 x 1.5	Brass	45 to 50 N·m
			Steel	75 to 80 N·m

How to Replace the Pad

Remove bolts with a hex. key wrench from the pad underside. Tighten new pad with the bolts ensuring there is no gap between the adapter plate and the pad.

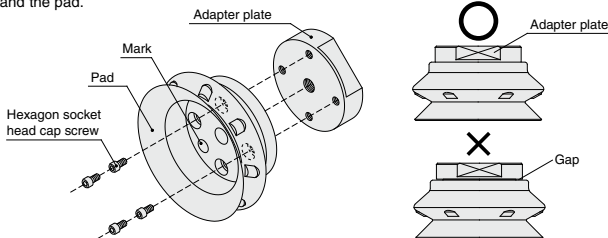

Model Selection

● Time of Replacement of Vacuum Pad

The vacuum pad is disposable. Replace it on a regular basis.

Continued use of the vacuum pad will cause wear and tear on the adsorption surface, and the exterior dimensions will gradually get smaller and smaller. As the pad diameter gets smaller, lifting force will decrease, though adsorption is possible.

It is extremely difficult to provide advice on the frequency of vacuum pad exchange. This is because there are numerous factors at work, including surface roughness, operating environment (temperature, humidity, ozone, solvents, etc.), and operating conditions (vacuum pressure, workpiece weight, pressing force of the vacuum pad on the workpiece, presence or absence of a buffer, etc.).

(Weakening of bent parts, wear, or sticking of rubber parts may occur with the bellows type pad.)

Thus, the customer should decide when the vacuum pad should be exchanged, based on its condition at time of initial use.

The bolt may become loose depending on the operating conditions and environment. Be sure to perform regular maintenance.

Recommended Tightening Torque for Replacement of Heavy-duty Pad

Pad diameter	Product specifications		Bolt tightening torque
	Product part no.	Bolt	
ø40, ø50	ZP (40/50) H□	M3 x 8	0.7 to 0.9 N-m
	ZP (40/50) HB□		
ø63, ø80	ZP (63/80) H□	M4 x 8	0.9 to 1.1 N-m
	ZP (63/80) HB□		
ø100, ø125	ZP (100/125) H□	M5 x 10	2.3 to 2.7 N-m
	ZP (100/125) HB□		

Tighten the nut to the recommended tightening torque.