

Series 10-AS

Speed Controller/In-line Type
10-AS1000, 2000, 3000, 4000, 5000

RoHS

How to Order



Clean series

Body size

1	M3, M5 standard
2	1/8, 1/4 standard
3	3/8 standard
4	1/2 standard
5	1/2 standard

In-line type

10 - AS 1 000 - M5 -

Port size

Port size	Applicable series
M3	M3 x 0.5
M5	M5 x 0.8
01	Rc1/8
02	Rc1/4
03	Rc3/8
04	Rc1/2

Lock nut option

Nil	Hexagon lock nut
J	Round lock nut

Note) The round lock nut option is only for AS1000.

Model/Flow Rate and Sonic Conductance

Model	Port size	Free flow			Controlled flow			Weight (g)
		Flow rate L/min (ANR)	Sonic conductance dm ³ /(s·bar)	Critical pressure ratio	Flow rate L/min (ANR)	Sonic conductance dm ³ /(s·bar)	Critical pressure ratio	
10-AS1000-M3	M3 x 0.5	20	0.06	0.15	20	0.06	0.2	4.7
10-AS1000-M5	M5 x 0.8	90	0.25		80	0.22		33
10-AS2000-01	1/8	340	0.94		250	0.7		90
10-AS2000-02	1/4	340	0.94		250	0.7		115
10-AS3000-02	1/4	810	2.3	0.35	810	2.3	0.2	130
10-AS3000-03	3/8	810	2.3		810	2.3		124
10-AS4000-02	1/4	1,670	4.6		1,670	4.6		221
10-AS4000-03	3/8	1,670	4.6		1,670	4.6		214
10-AS4000-04	1/2	1,670	4.6		1,670	4.6		205
10-AS5000-02	1/4	2,840	7.9		2,840	7.9		242
10-AS5000-03	3/8	4,270	11.9		4,270	11.9		233
10-AS5000-04	1/2	4,270	11.9		4,270	11.9		224

Note) Supply pressure: 0.5 MPa, Temperature: 20°C.

Specifications

Proof pressure ^{Note)}	1.5 MPa (1.05 MPa)
Operating pressure range ^{Note)}	0.05 to 1.0 MPa (0.1 to 0.7 MPa)
Ambient and fluid temperature	-5 to 60°C (No freezing)
Grease	Fluorine grease
Cleanliness class (ISO class)	Class 3

Note) Descriptions in parentheses are for 10-AS1000.

Directional Control Valves

Air Cylinders

Rotary Actuators

Air Grippers

Air Preparation Equipment

Modular F. R.

Pressure Control Equipment

Fittings & Tubing

Flow Control Equipment

Pressure Switches/Pressure Sensors

Needle Valve / Flow Rate Characteristics

10-AS1000-M3

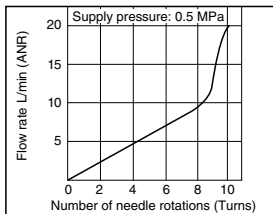

10-AS1000-M5

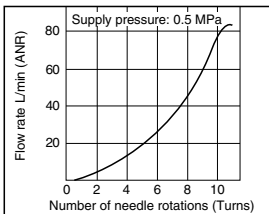

10-AS2000

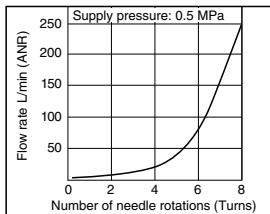

10-AS3000

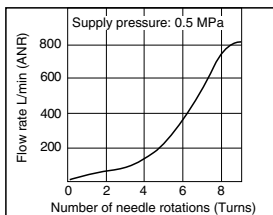

10-AS4000

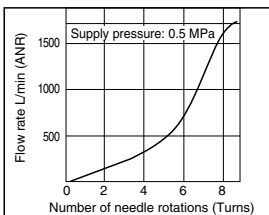

10-AS5000

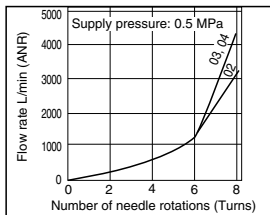

Dimensions

10-AS1000-M3

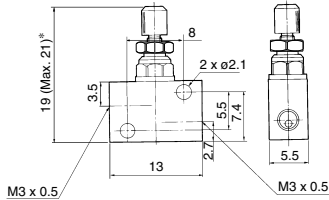

* Reference dimensions

10-AS1000-M5

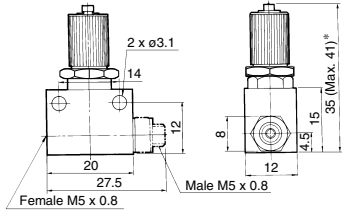

* Reference dimensions

10-AS2000/3000

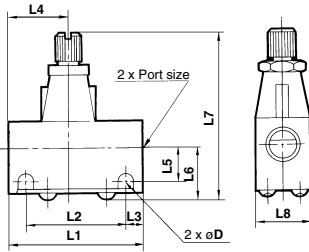

10-AS4000

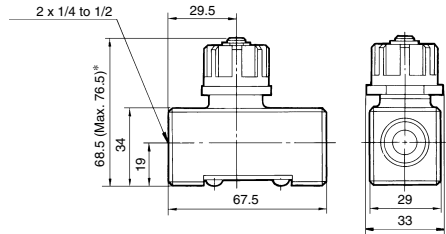

Dimensions

Model	Port size	L1	L2	L3	L4	L5	L6	L7 MAX. MIN.	L8	D
10-AS2000-01	1/8	40	30	5	17	10	15.5	54.5 50	16	4.5
10-AS2000-02	1/4				23	11.5	17	56 51.5	20	
10-AS3000-02/03	1/4, 3/8	56	45.5	5.25	25	13.2	20.6	68 61	26	5.5

10-AS5000

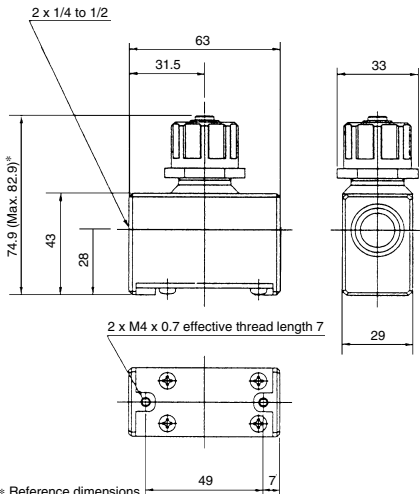

* Reference dimensions

* Reference dimensions

2 x M4 x 0.7
Effective thread length 6

Directional Control Valves

Air Cylinders

Rotary Actuators

Air Grippers

Air Preparation Equipment

Modular F. R.

Pressure Control Equipment

Fittings & Tubing

Flow Control Equipment

Pressure Switches/ Pressure Sensors