

# Fieldbus System

(For Input/Output)



RoHS

IP67

## Supports digital inputs/outputs, analog inputs/outputs, and IO-Link masters

**New**

IO-Link master unit compatible products have been added.

- 2 models (port class A and port class B)
  - Up to 4 modules can be connected.
  - Master/device diagnosis function
  - The data can be accessed from via PC (setting tool).
  - Device parameter setting function, Automatic saving/writing
- \* Only the EtherNet/IP™ compatible SI unit (made to order) is applicable. [p. 42](#)



<Compatible Protocols>



DeviceNet

CC-Link

IO-Link



EtherNet/IP

EtherCAT

Made to order



ETHERNET POWERLINK

CC-Link IE Field

Please contact SMC for details on compatible products.

### Self-diagnosis function

Equipped with an input/output open/short-circuit detection function and an input/output signal ON/OFF counter function

### Web server function\*1

Status checks, parameter setting, and forced output are possible via web browser.

\*1 EtherNet/IP™ only

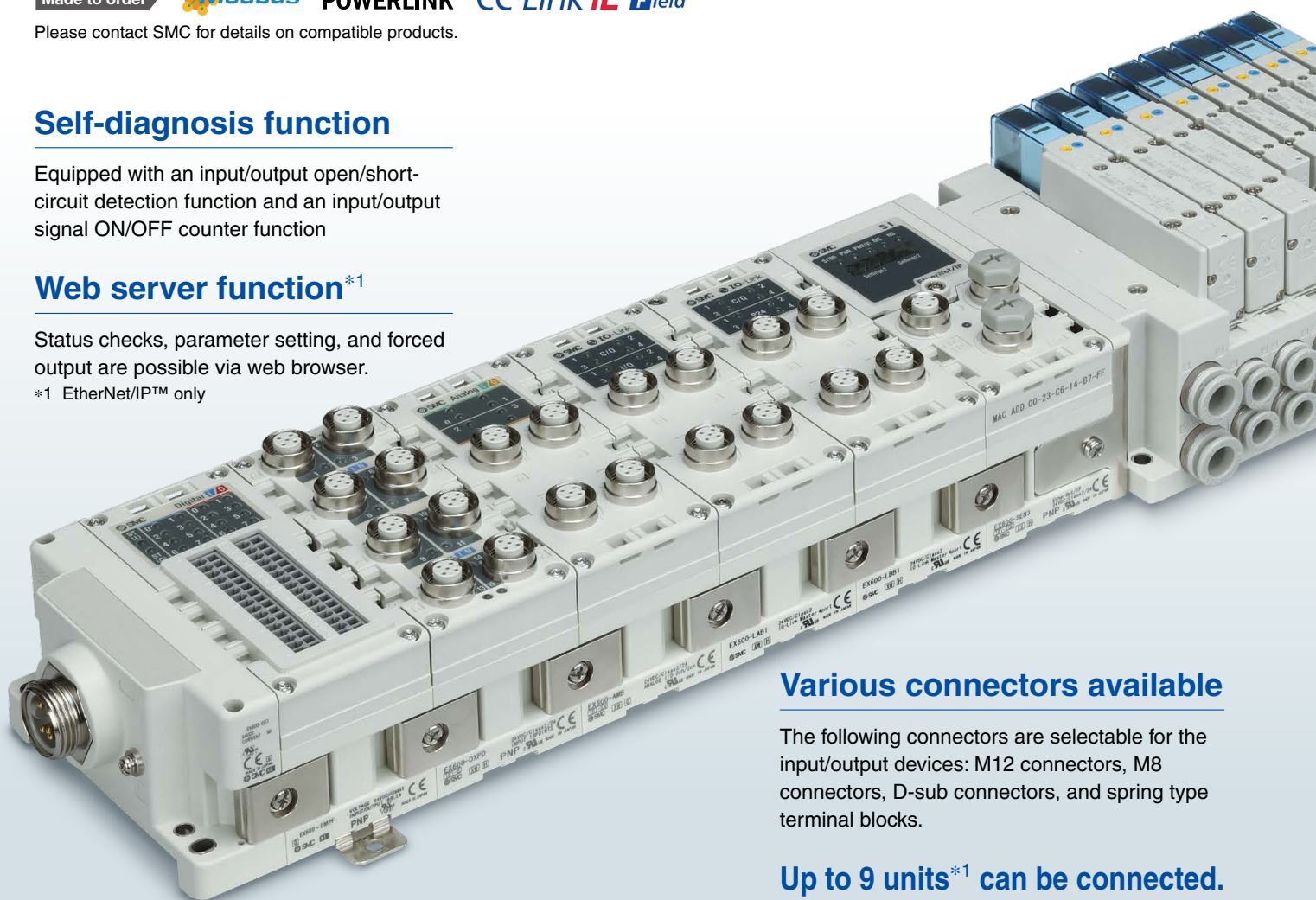

### Various connectors available

The following connectors are selectable for the input/output devices: M12 connectors, M8 connectors, D-sub connectors, and spring type terminal blocks.

### Up to 9 units\*1 can be connected.

Up to 9 units can be connected in any order.

\*1 Excludes SI units

# EX600 Series



CAT.E02-24F

# Can be connected with digital, analog, and IO-Link master units

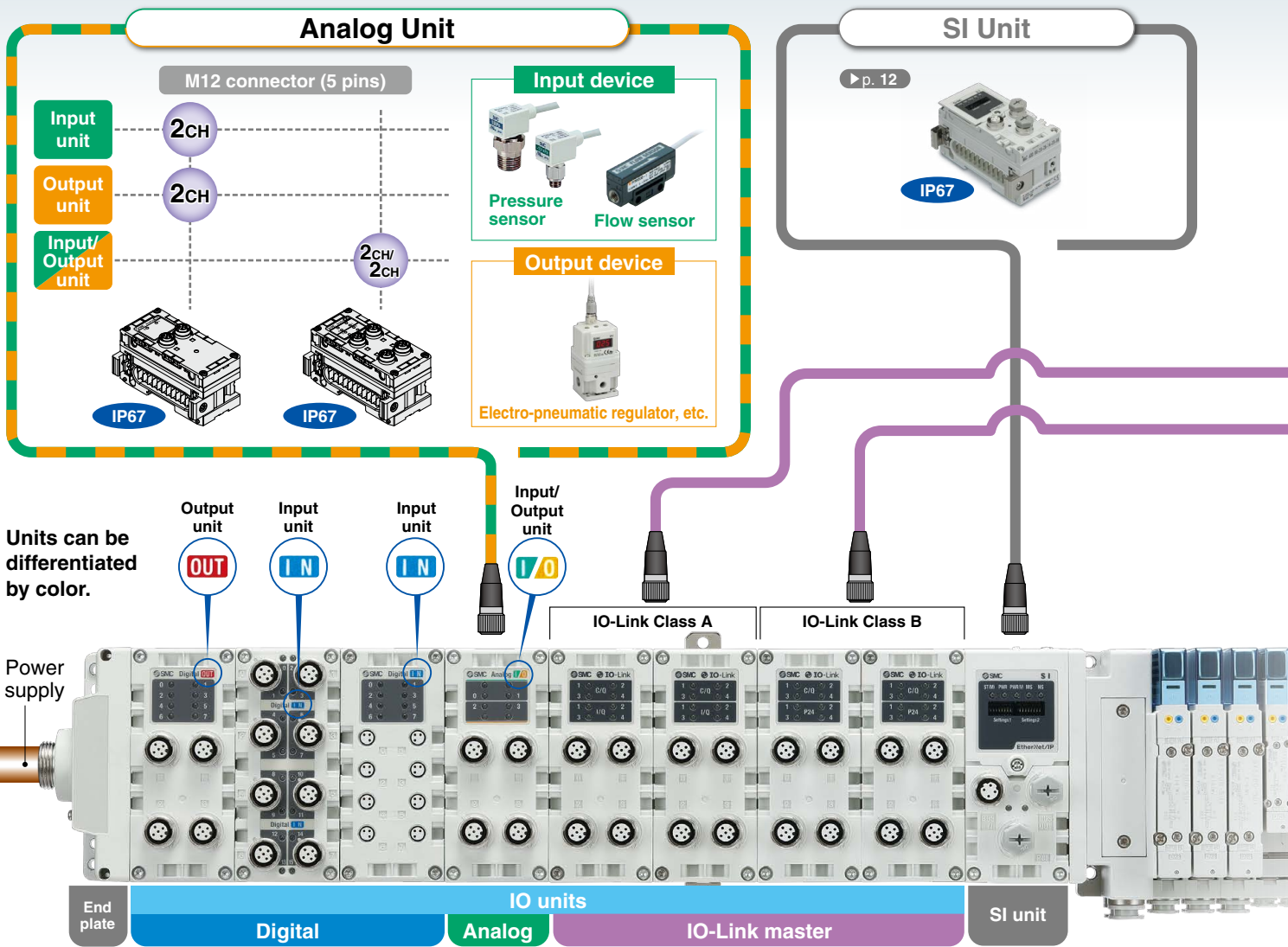

For detailed specifications of connectable devices, refer to the catalog of each device and select the right device for your application. If anything is unclear, please contact SMC.

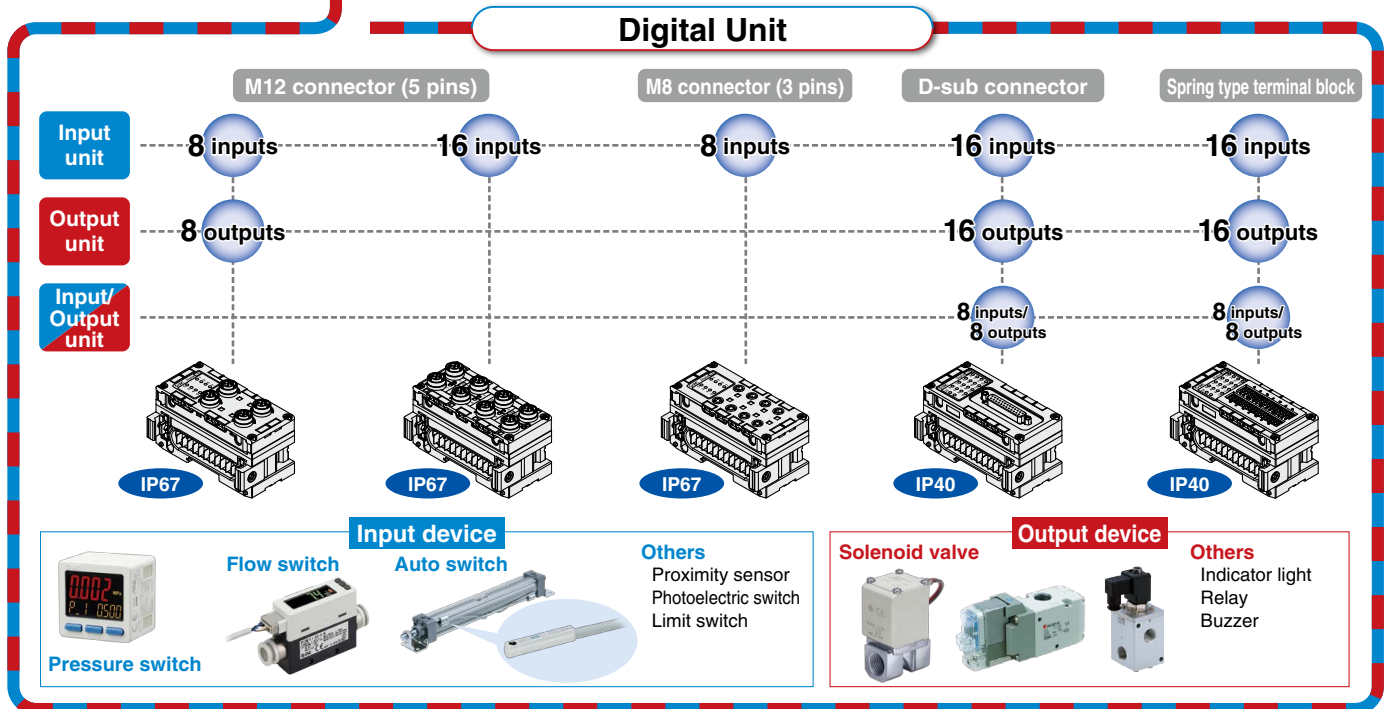

## IO-Link Master Unit / Port Class A Devices

Master unit  
Port class A

M12 connector (5 pins)

4  
ports

### Input devices

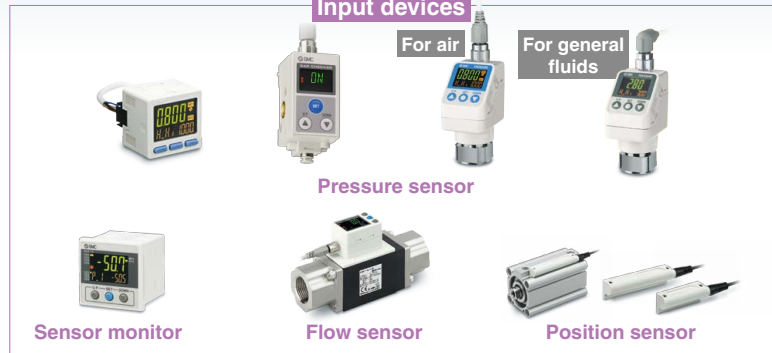

### Input/Output devices

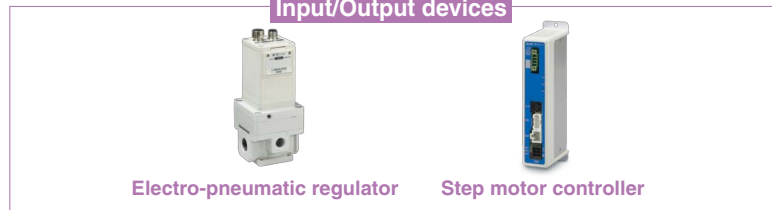

## IO-Link Master Unit / Port Class B Device

Master unit  
Port class B





M12 connector (5 pins)

4  
ports

### Output device



## Connectable Solenoid Valve Series

Series	Flow rate characteristics (4/2 → 5/3)		Max. number of solenoids	Power consumption [W]	Applicable cylinder size
	C [dm <sup>3</sup> /(s·bar)]	b			
IP67 <sup>*1</sup> 	SY3000	1.6	0.19	32	0.35 (Standard) 0.1 (With power-saving circuit)
	SY5000	3.6	0.17		
	SY7000	5.9	0.20		
IP67 <sup>*1, *3</sup> 	JSY1000	0.91	0.48	32	0.2 (With power-saving circuit) 0.4 (Standard) 0.1 (With power-saving circuit)
	JSY3000	2.77	0.27		
	JSY5000	6.59	0.22		
IP40 	S0700 <sup>*2</sup>	0.37	0.39	32	0.35
IP67 <sup>*1</sup> 	SV1000 <sup>*2</sup>	1.1	0.35	32	0.6
	SV2000 <sup>*2</sup>	2.4	0.18		
	SV3000 <sup>*2</sup>	4.3	0.21		
IP67 <sup>*1</sup> 	VQC1000	1.0	0.30	24	0.4 (Standard) 0.95 (Standard) 0.4 (Low-wattage type)
	VQC2000	3.2	0.30		
	VQC4000	7.3	0.38		
	VQC5000	17	0.31		

\*1 Units with a D-sub communication connector are IP40.

\*2 There is no manifold part number setting for the IO-Link compatible units. (Please order separately.)

\*3 The JSY1000 is IP40.

# IO-Link

IO-Link is a communication technology for sensors and actuators that is an international standard, IEC61131-9.

This technology is used to send/receive device information such as manufacturer, product part number, parameters, and diagnostic data, as well as the control data including ON/OFF signals and measured values of the sensor, by connecting the IO-Link master and sensor in a 1:1 configuration.

IO-Link enables condition monitoring and error detection of the sensor and equipment, and it can contribute to the reduction of startup labor and recovery time and the realization of preventive and predictive maintenance.

## Reduced design and startup labor

- Batch setting of device parameters from the upper level
- Remote check of device information
- Detection and remote unified check of device misconnection/non-connection

## Minimum recovery time due to error detection

- Early detection of location where problem is occurring via communication
- Early obtaining of information on problem phenomenon via communication
- Early recovery during product replacement (automatic setting of device parameters)

## Preventive and predictive maintenance through condition monitoring

- Monitors changes in measured values of a sensor during signal ON/OFF
- Monitors the number of device operations and automatically notifies when the set number of operations has been exceeded
- Remote monitoring of device and equipment conditions via communication

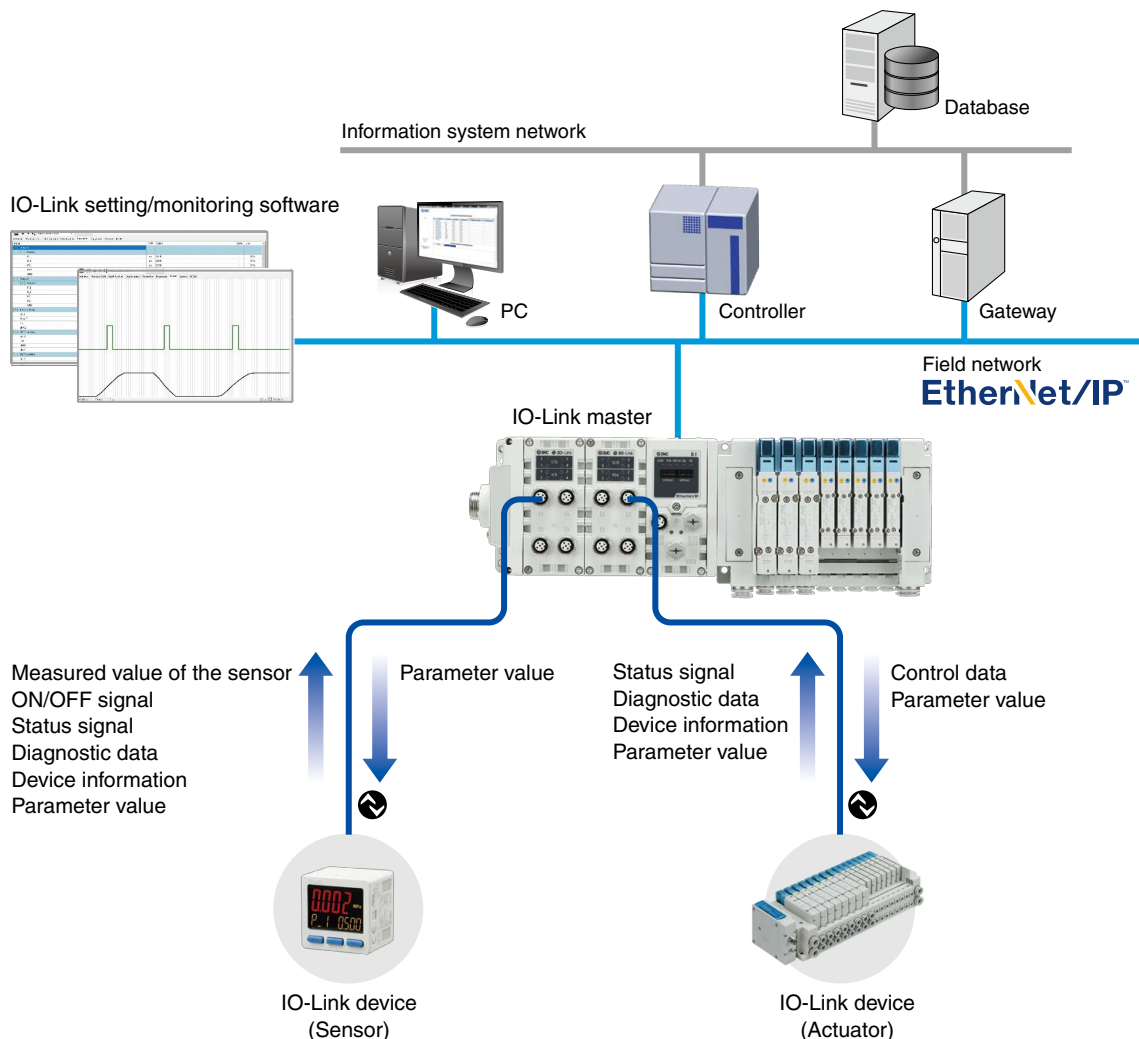

# IO-Link System Configuration

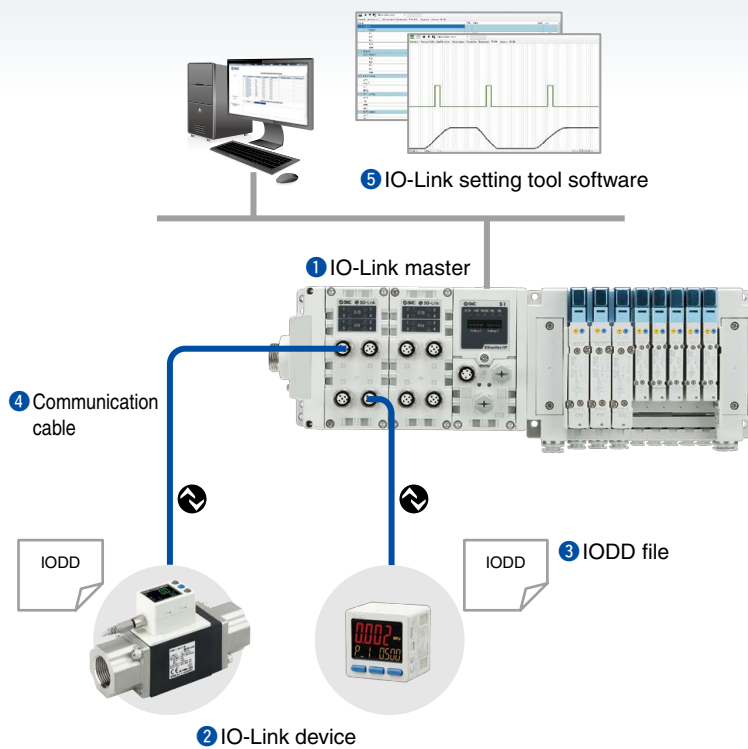

## 1 IO-Link master

- Acts as a gateway between the IO-Link communication and the upper level communication

## 2 IO-Link device

- A sensor/actuator connecting to an IO-Link master in a 1:1 configuration

## 3 IODD file

- A file in which device properties and parameters are described
- Registered to the setting tool
- Provided by the device manufacturer

## 4 Communication cable

- A 4-wire or 5-wire general-purpose cable that is the same as the existing sensor cable (Unshielded cable)
- Max. cable length: 20 m

## 5 IO-Link setting tool software

- Software for the setting and monitoring of a master/device
- Provided by the master manufacturer\*1

\*1 A setting tool compatible with the masters of every manufacturer is used for the SMC EX600 series IO-Link master. (IO-Link Device Tool V5 manufactured by TMG Technologie und Engineering, Germany)

# IO-Link Interface

The connecting part between the IO-Link master and the device is called a “port.” Each port can be switched between “IO-Link mode” for digital communication and “standard I/O mode” for conventional contact input/output.

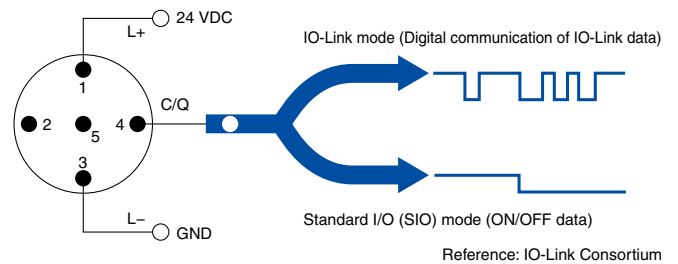

## 2 types of interfaces

There are two methods for power supply: one is for sensors, and the other is for actuators.

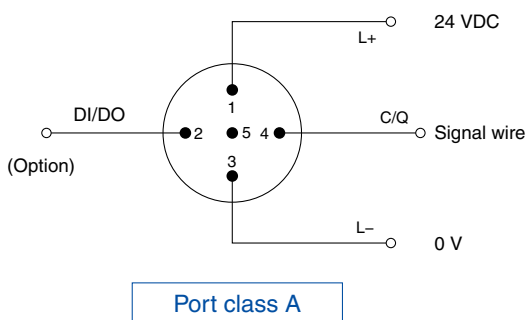

The control power supply wire and signal wire can be connected with one cable. (Mainly for sensors)

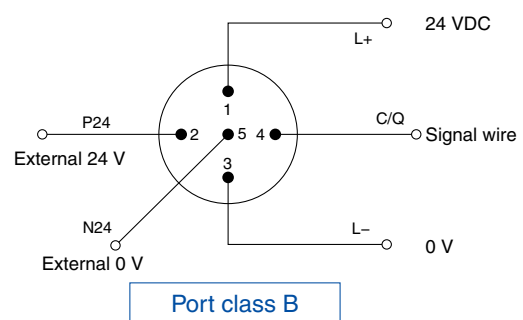

The control power supply wire, external power supply wire, and signal wire can be connected with one cable. (Mainly for actuators)

# IO-Link Master Unit

## Can be connected with digital, analog, and IO-Link master units

Up to 4 IO-Link master units can be connected. (Total of 16 ports)

\* When connecting the EtherNet/IP™ unit

Digital units, analog units, and IO-Link master units can be mixed, and up to 9 units can be connected in any order.

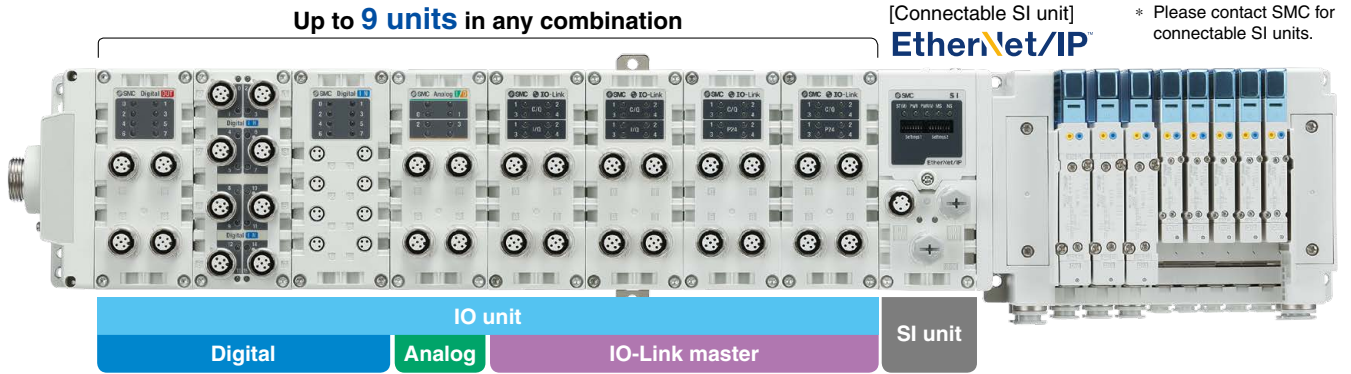

## Supports both port class A and port class B

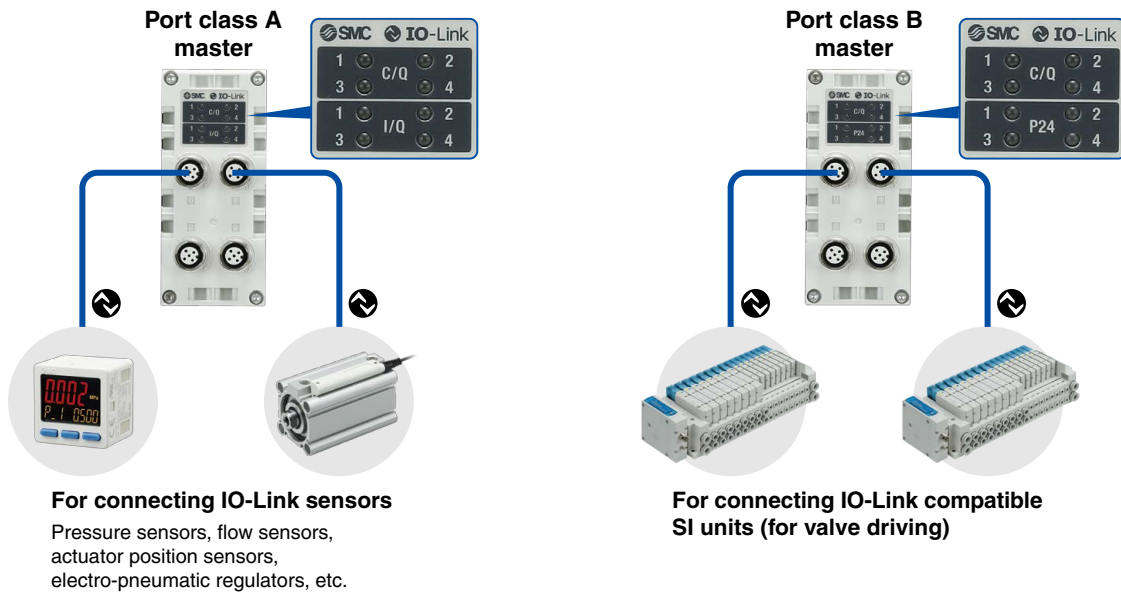

## The data can be accessed from via PC (setting tool).

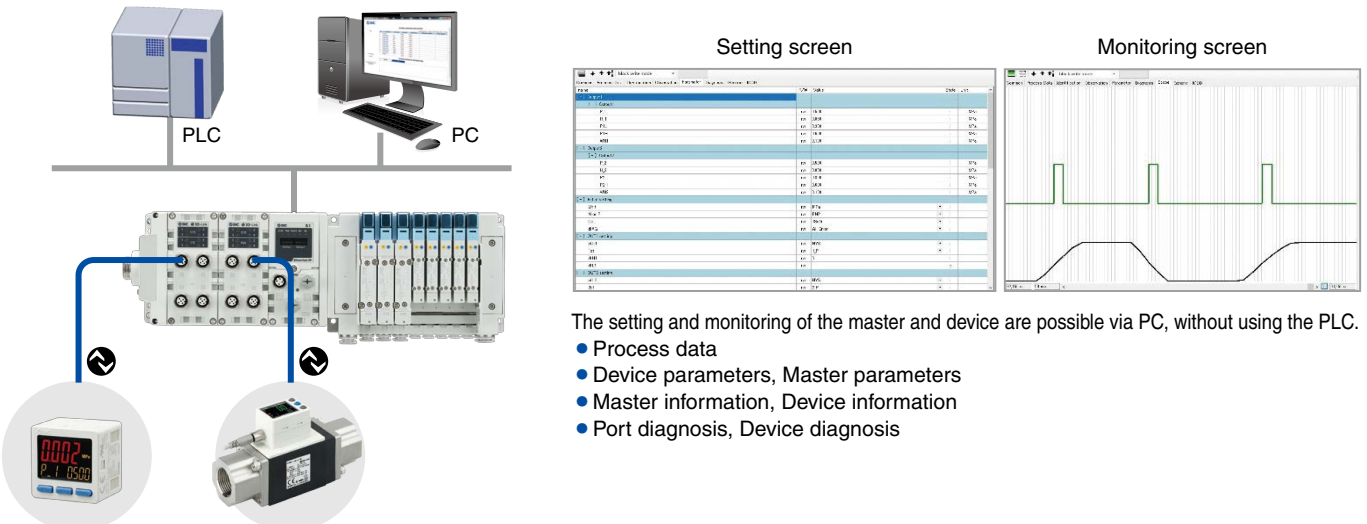

## ■ Diagnosis function

**Diagnosis on a master and device is possible from the upper level communication.**

Master (port) diagnostic information can be obtained via PLC program or PC (web browser).

Device diagnostic information can be obtained via PC (setting tool).

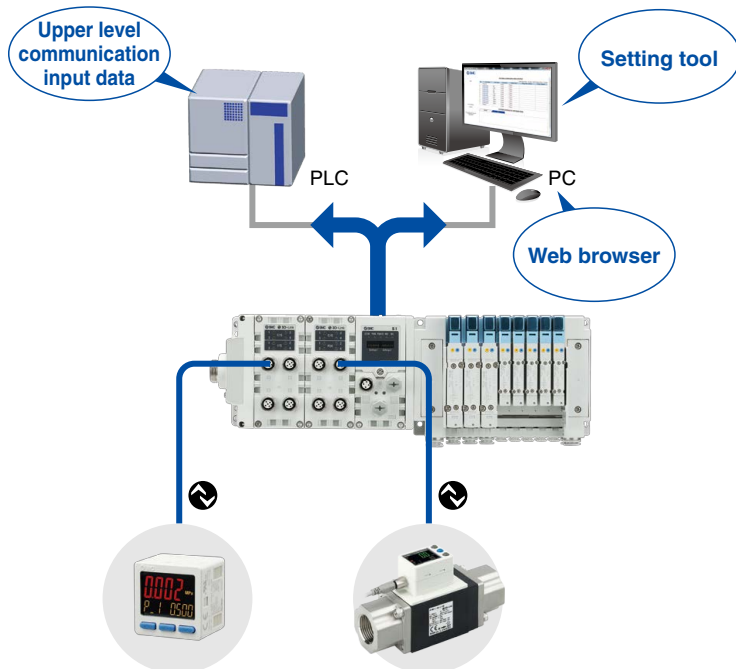

Items of master (port) diagnosis
Detection of port short-circuit
Detection of non-connected device
Detection of misconnected device (check error)
Notification of port misconfiguration (excessively large input/output data)
Conditions of diagnostic event (port, device)
Items of device diagnosis
Diagnostic results (problem phenomenon) received from devices are shown in event codes.

## ■ Device parameter setting function, Automatic saving/writing

**The parameter setting of devices is possible from the upper level communication.**

Parameter setting is possible via PC (setting tool).

It is also possible to use output data or message data via PLC program.\*1

\*1 For EtherNet/IP™ communication

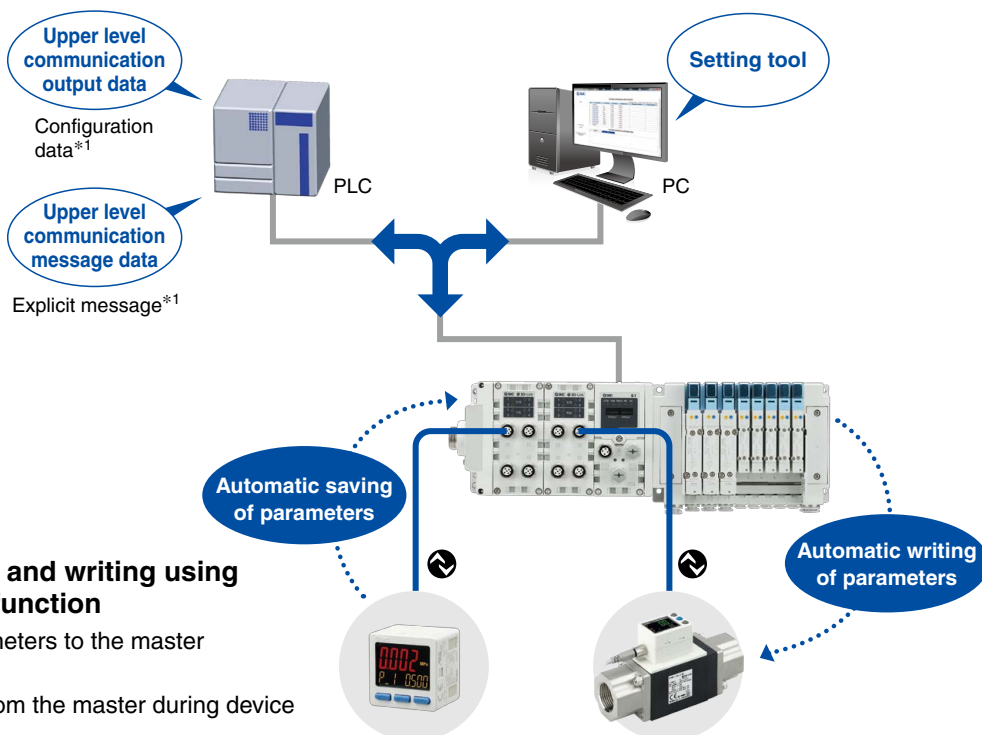

### Automatic saving and writing using the data storage function

- Saves device parameters to the master automatically
- Automatic writing from the master during device replacement

# Functions of EtherNet/IP™

The following functions are available for the dual-port EtherNet/IP™ product (EX600-SEN3/4).

## Added: Compatible topologies (Connection configuration)

### EX600-SEN3/4

The dual-port product (EX600-SEN3/4) is available for both the linear and device level ring topologies, in addition to the star type.

#### Linear type

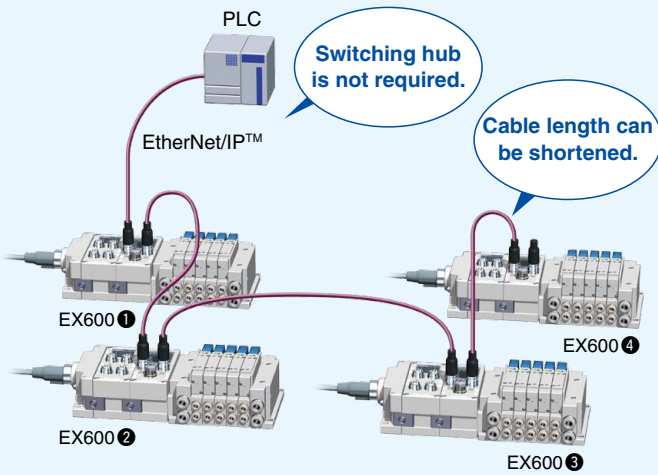

#### Device level ring (DLR) type

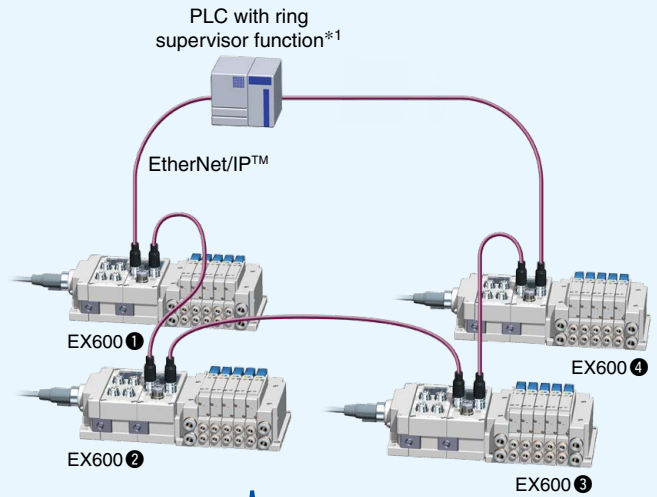

\*1 One or more ring supervisors are required.

For the device level ring type, even if the communication cable is disconnected in one location, EtherNet/IP™ communication can be continued, and the disconnected portion can be specified by the ring supervisor.

#### Normal flow of data

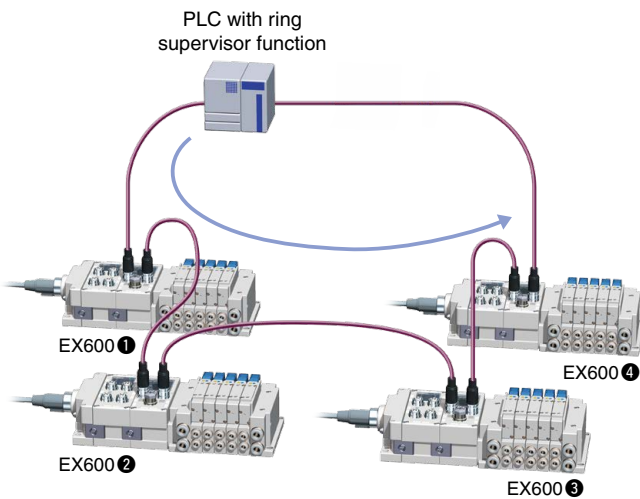

#### Data flow when the communication cable is disconnected

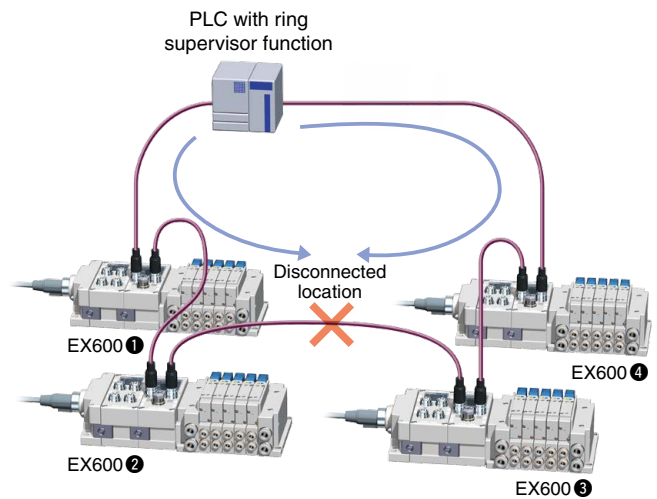



## QuickConnect™ function available

Time from power ON to communication connection

10 s

Approx.  
**0.5 s**

For tool changers, it takes about 10 seconds for communication to be connected in common EtherNet/IP™ products after the power of the device installed on the tool is turned ON. Since the QuickConnect™ function\*1 is available for the EX600-SEN3/4, communication can be connected in about 0.5 seconds.

\*1 To use the QuickConnect™ function, the PLC should be able to support the QuickConnect™ function.

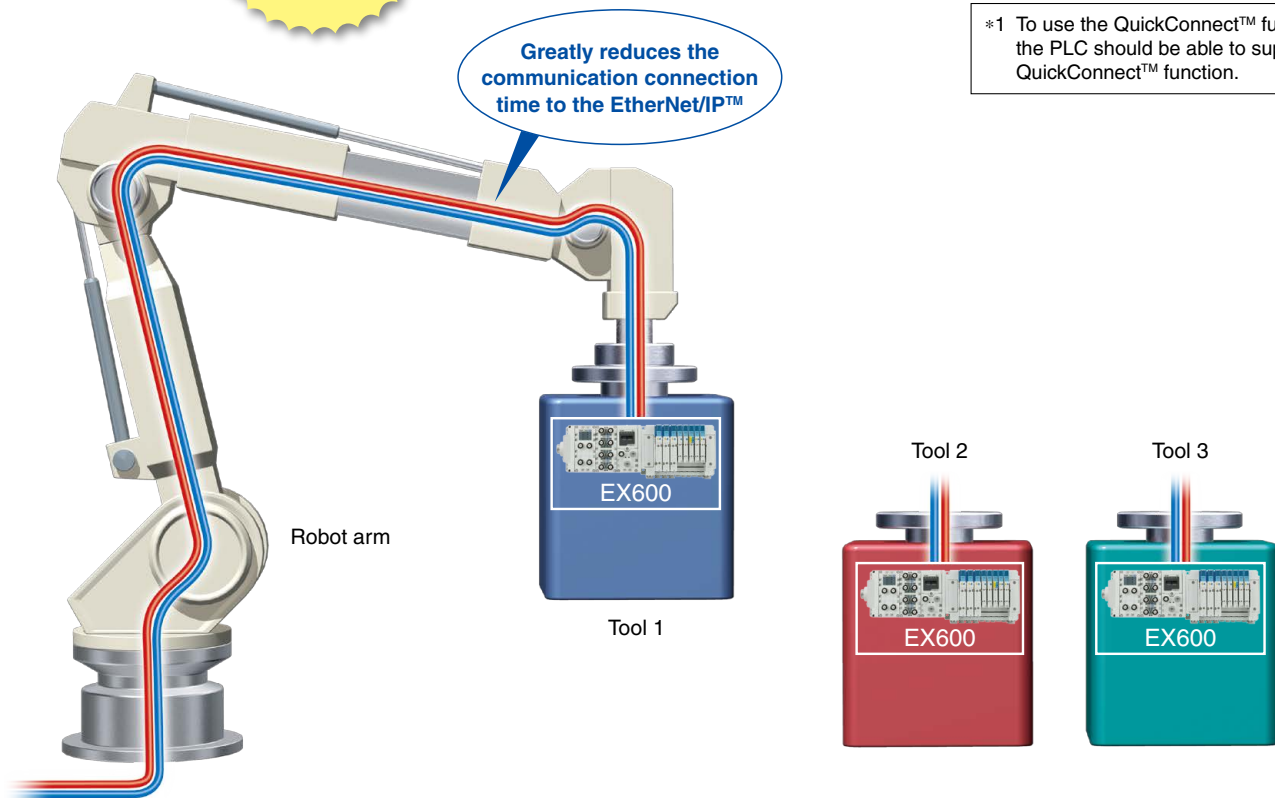

## Built-in web server function

The EX600-SEN3/4 has a built-in web server function, which enables status checks, parameter settings, and forced output of the EX600 using general-purpose web browsers, such as Internet Explorer. Start-up of the system and maintenance can be performed efficiently.

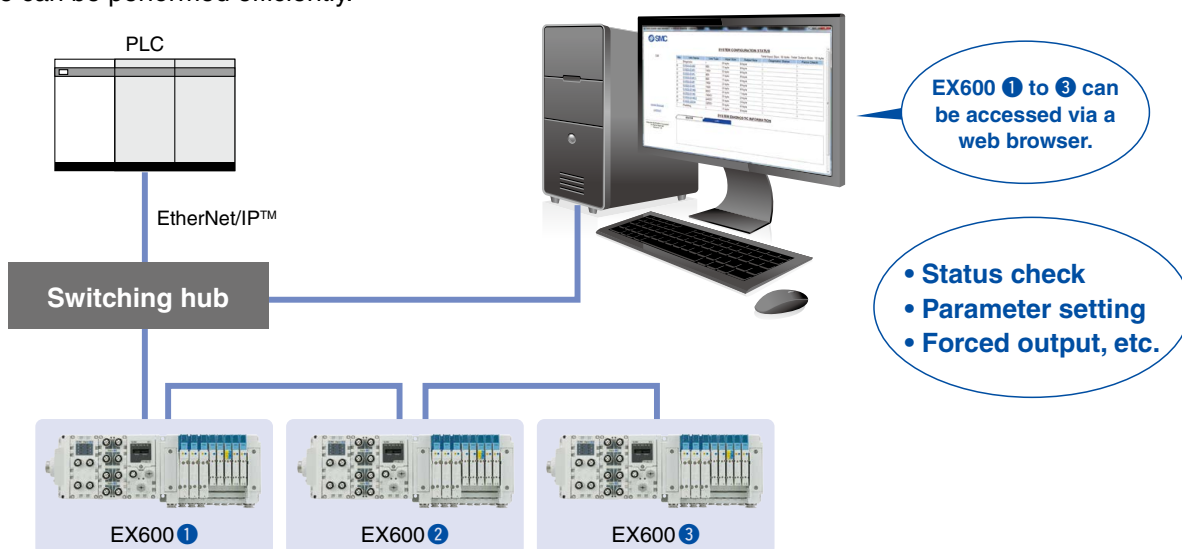

Connection example

# Fieldbus System EX600

## D-sub connector

IP40

These units are capable of connection using a D-sub connector. There are three types of units: for digital input, output, and input/output. The digital output unit can be connected with an SMC manifold solenoid valve F kit (D-sub connector).

**Manifold solenoid valves can be connected using a cable with a D-sub connector.**

- SY series      • S0700 series      • SJ series      • SQ series
- SV series      • VQC series      • VQ series      • JSY series

\* Please limit the number of valve connections to 16 stations for single and 8 stations for double. Refer to the catalog of each product for pin assignment details.

VVZS3000-21A-□-X192 (Non-waterproof cable example)

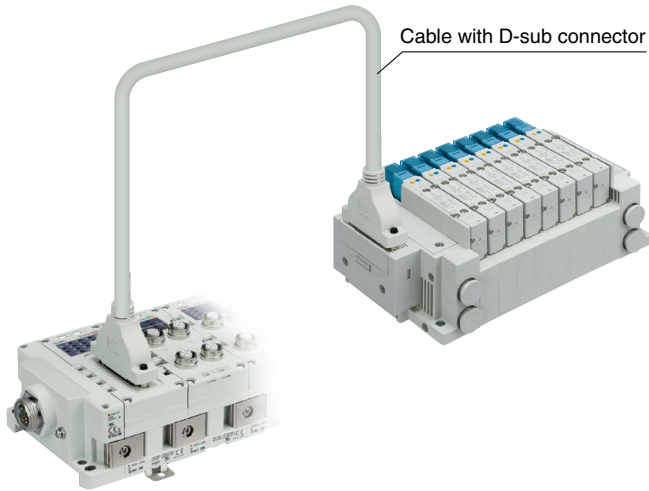

## Spring type terminal block

IP40

These terminal block units are compatible with individual wiring configurations. There are three types of units: for digital input, output, and input/output. Wiring connection to a sensor connector box, etc., can be carried out easily using only a flat head screwdriver.

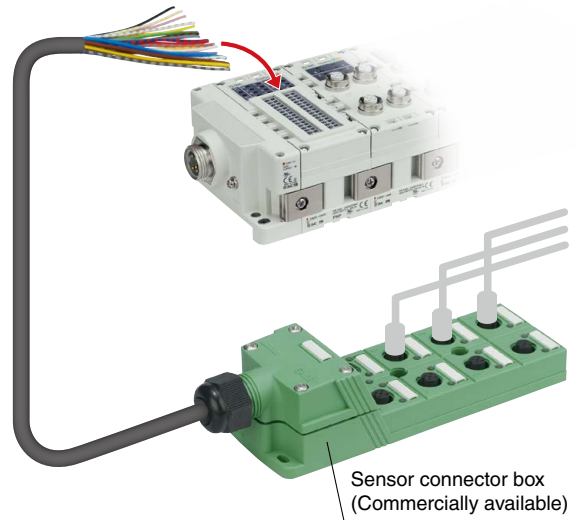

## Digital input unit

IP67

This unit is for inputting a digital signal (ON/OFF signal). The signal of a 2-wire/3-wire auto switch attached to the actuator can be acquired to feedback a signal to the PLC. The control signal of an entire system can be managed by a Fieldbus system.

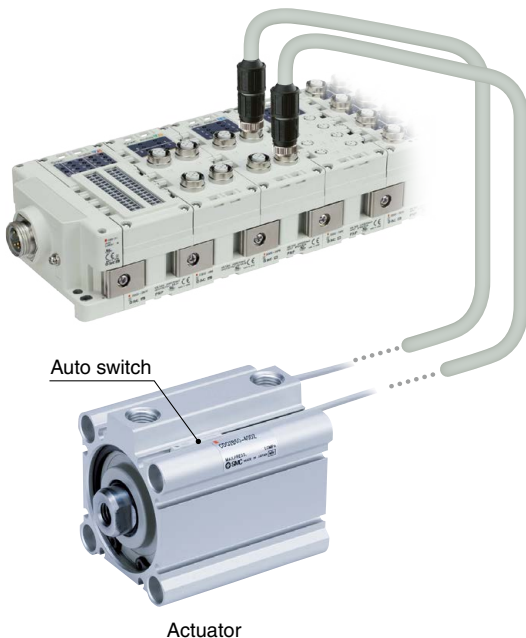

## Analog input/output unit

IP67

These units are for inputting or outputting an analog signal (voltage/current). A single unit performs both input and output, allowing feedback control where analog signals are received from a pressure sensor and sent to a pressure controller. Installation space is minimized as well.

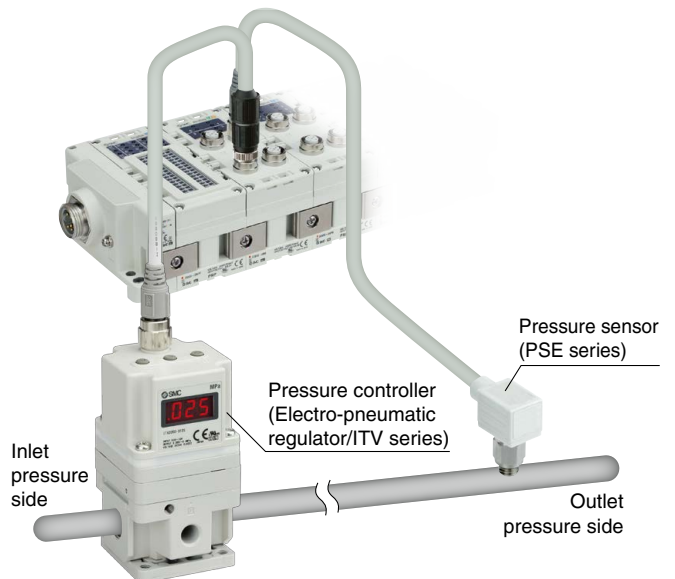

## Self-diagnosis function

The following shows examples of the self-diagnosis function.

### Short/Open-circuit detection

It is possible to detect short or open circuits of input devices such as electronic 2-wire switches and 3-wire switches and output devices such as solenoid valves. The location of the error can be identified by the indicator light and the network.



Green ON Normal



Red ON Short circuit

Red flashing Open circuit

### Counter function

It is possible to ascertain the maintenance period and identify the parts that require maintenance by an input and output signal ON/OFF counter function. When the counter function is enabled and a certain number of contact operations is reached, the display of the counter will flash in red.

\* The counter function is not provided with analog units.

## Individual units can be connected and removed one by one.

A unique clamping method is adopted to prevent screws from falling out.

Units can be separated easily by loosening the joint bracket.

Up to 9 units can be connected in any order.

\* Excludes SI units

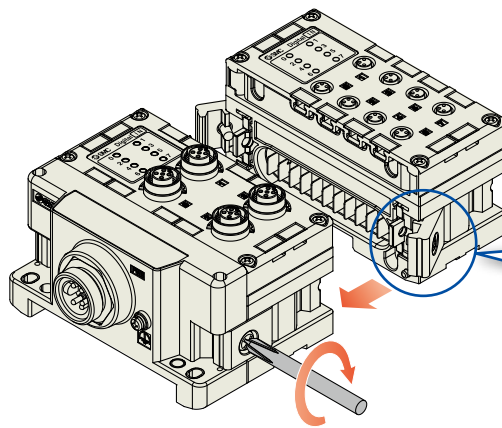

# CONTENTS

## Type 3 Integrated input-output type

### Fieldbus System (For Input/Output)

### EX600 Series

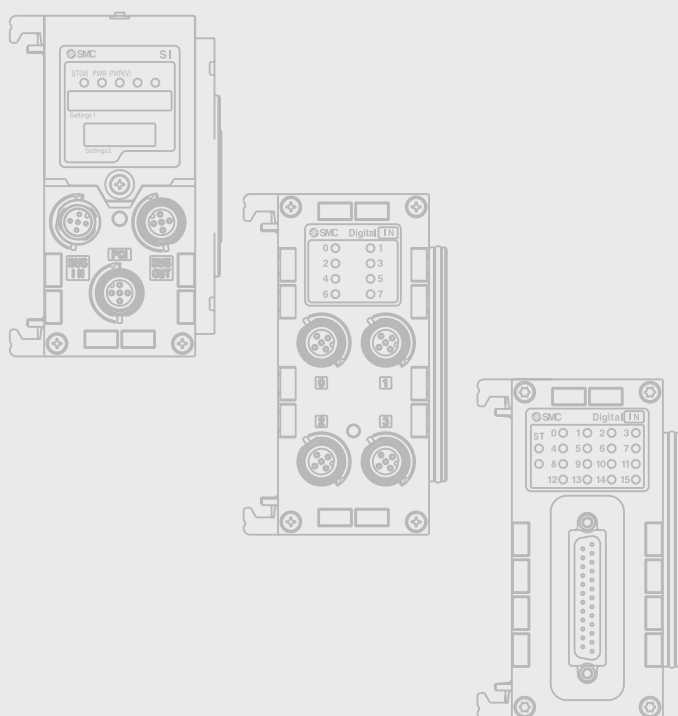
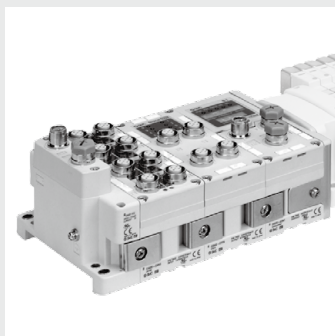

<b>Parts Structure</b> .....	p. 12
<b>How to Order</b>	

SI Unit .....	p. 12
Digital Input Unit .....	p. 13
Digital Output Unit .....	p. 13
Digital Input/Output Unit .....	p. 13
Analog Input Unit .....	p. 13
Analog Output Unit .....	p. 13
Analog Input/Output Unit .....	p. 14
IO-Link Master Unit .....	p. 14
End Plate (D side) .....	p. 14
Handheld Terminal .....	p. 14

#### Specifications

All Units Common .....	p. 15
SI Unit .....	p. 15
Digital Input Unit .....	p. 17
Digital Output Unit .....	p. 18
Digital Input/Output Unit .....	p. 18
Analog Input Unit .....	p. 19
Analog Output Unit .....	p. 19
Analog Input/Output Unit .....	p. 20
IO-Link Master Unit .....	p. 21
End Plate .....	p. 21
Handheld Terminal .....	p. 21

<b>Dimensions</b> .....	p. 22
-------------------------	-------

<b>Parts Description</b> .....	p. 25
--------------------------------	-------

<b>LED Indicator</b> .....	p. 27
----------------------------	-------

#### Accessories

① End Plate Bracket .....	p. 31
② Valve Plate .....	p. 31
③ End Plate (U side) .....	p. 32
④ Reinforcing Brace .....	p. 32
⑤ Seal Cap (10 pcs.) .....	p. 32
⑥ Marker (1 sheet, 88 pcs.) .....	p. 32
⑦ Power Supply Cable (7/8 inch connector) .....	p. 33
⑧ Power Supply Field-wireable Connector (7/8 inch) .....	p. 33
⑨ Power Supply Cable (M12 connector, For EX600-ED2) .....	p. 33
⑩ Power Supply Cable (M12 connector, For EX600-ED4/5) .....	p. 34
⑪ Communication Cable .....	p. 35
⑫ Field-wireable Communication Connector .....	p. 40
⑬ I/O Cable with Connector, I/O Connector .....	p. 41

#### Made to Order

① MRP (PROFINET) compatible .....	p. 42
② Ethernet POWERLINK compatible .....	p. 42
③ Modbus/TCP compatible .....	p. 42
④ CC-Link IE Field compatible .....	p. 42
⑤ EtherNet/IP™ IO-Link master unit compatible .....	p. 42
Communication Cable .....	p. 43

Specific Product Precautions .....	p. 44
------------------------------------	-------

# Fieldbus System For Input/Output

# EX600 Series



## Parts Structure

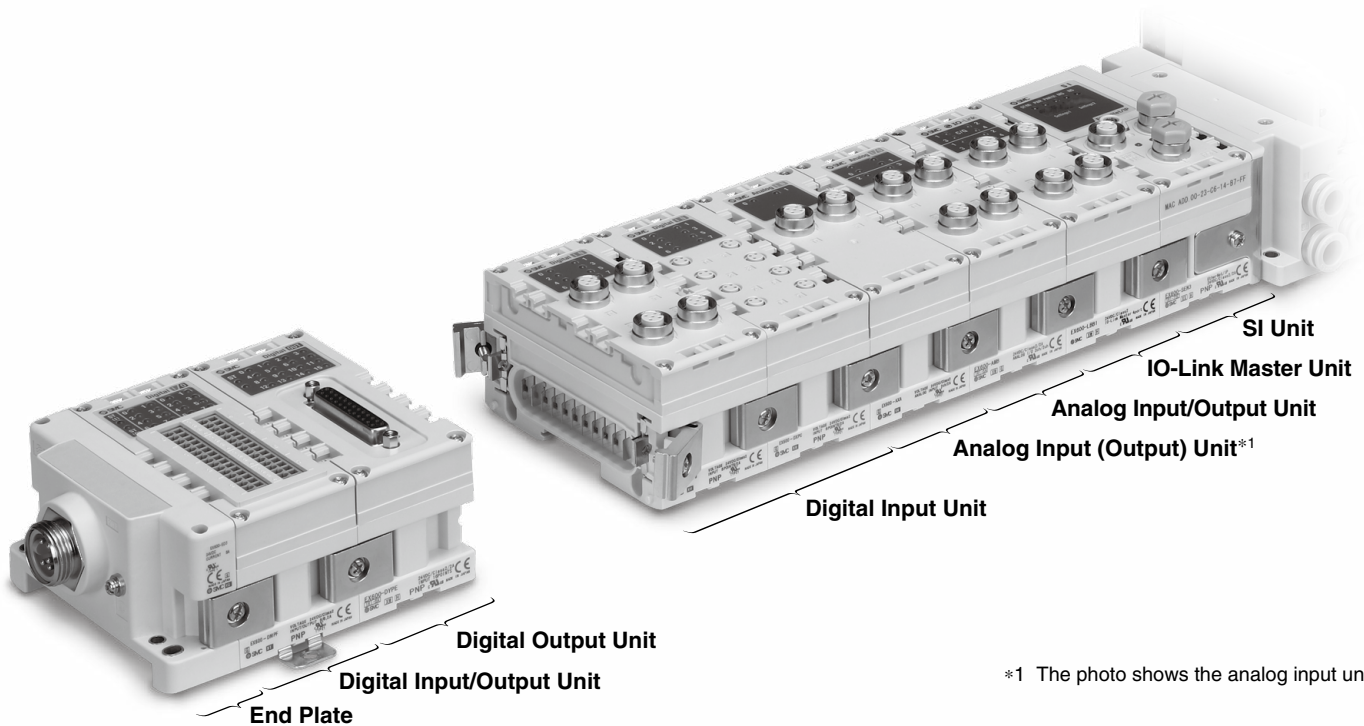

## How to Order

SI Unit

EX600 - S PR1A - [ ]

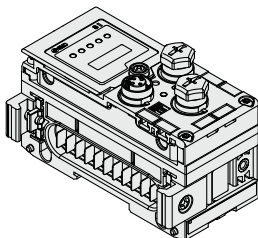

### Specifications

Symbol	Protocol	Output type	Note
PR1A	PROFIBUS DP	PNP (Negative common)	—
PR2A		NPN (Positive common)	—
DN1A	DeviceNet™	PNP (Negative common)	—
DN2A		NPN (Positive common)	—
MJ1	CC-Link	PNP (Negative common)	—
MJ2		NPN (Positive common)	—
EN1	EtherNet/IP™	PNP (Negative common)	—
EN2		NPN (Positive common)	—
EN3		PNP (Negative common)	2 ports
EN4		NPN (Positive common)	2 ports
EC1	EtherCAT	PNP (Negative common)	—
EC2		NPN (Positive common)	—
PN1	PROFINET	PNP (Negative common)	—
PN2		NPN (Positive common)	—

• Made to order  
(Refer to page 42.)

MRP (PROFINET)
Ethernet POWERLINK
Modbus TCP
CC-Link IE Field
EtherNet/IP™
IO-Link master unit

# EX600 Series

## How to Order

### Digital Input Unit

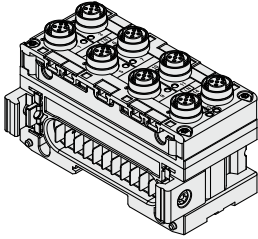

## EX600-DX P D

#### Input type

Symbol	Description
P	PNP
N	NPN

#### Number of inputs, open-circuit detection, and connector

Symbol	Number of inputs	Open-circuit detection	Connector
B	8 inputs	No	M12 connector (5 pins) 4 pcs.
C	8 inputs	No	M8 connector (3 pins) 8 pcs.
C1	8 inputs	Yes	M8 connector (3 pins) 8 pcs.
D	16 inputs	No	M12 connector (5 pins) 8 pcs.
E	16 inputs	No	D-sub connector (25 pins)
F	16 inputs	No	Spring type terminal block (32 pins)

### Digital Output Unit

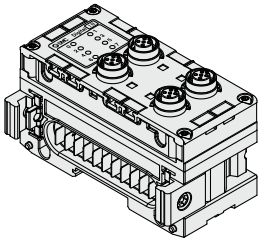

## EX600-DY P B

#### Output type

Symbol	Description
P	PNP
N	NPN

#### Number of outputs and connector

Symbol	Number of outputs	Connector
B	8 outputs	M12 connector (5 pins) 4 pcs.
E	16 outputs	D-sub connector (25 pins)
F	16 outputs	Spring type terminal block (32 pins)

### Digital Input/Output Unit

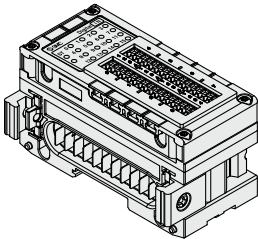

## EX600-DM P F

#### Input/Output type

Symbol	Description
P	PNP
N	NPN

#### Number of inputs/outputs and connector

Symbol	Number of inputs	Number of outputs	Connector
E	8 inputs	8 outputs	D-sub connector (25 pins)
F	8 inputs	8 outputs	Spring type terminal block (32 pins)

### Analog Input Unit

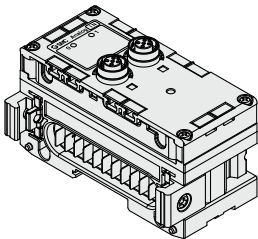

## EX600-AX A

#### Analog input

#### Number of input channels and connector

Symbol	Number of input channels	Connector
A	2 channels	M12 connector (5 pins) 2 pcs.

### Analog Output Unit

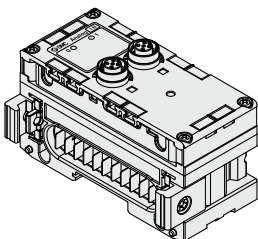

## EX600-AY A

#### Analog output

#### Number of output channels and connector

Symbol	Number of output channels	Connector
A	2 channels	M12 connector (5 pins) 2 pcs.

**How to Order**

**Analog Input/Output Unit EX600-AM B**

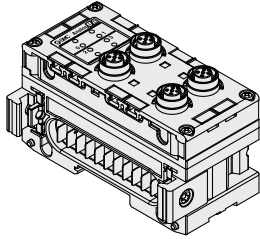

Analog input/output

Number of input/output channels and connector

Symbol	Number of input channels	Number of output channels	Connector
<b>B</b>	2 channels	2 channels	M12 connector (5 pins) 4 pcs.

**IO-Link Master Unit EX600-L A B 1**

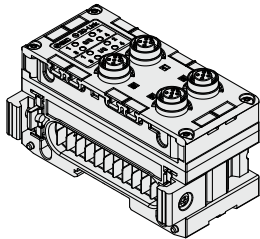

Port specification

Number of ports and connector

Symbol	Description
<b>A</b>	Port class A
<b>B</b>	Port class B

Symbol	Number of ports	Connector
<b>B</b>	4 ports	M12 connector (5 pins) 4 pcs.

**Caution**

The only available SI unit part number is "EX600-SEN3-X80" (EtherNet/IP™ compatible). Refer to page 42.

**End Plate (D side) EX600-ED 2 - 2**

EX600-ED4/5 are not yet UL-compliant.

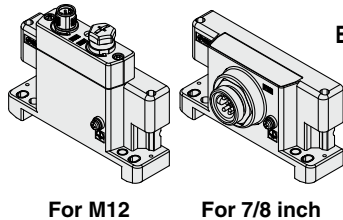

For M12

For 7/8 inch

End plate

End plate mounting position: D side

Power supply connector

Symbol	Power supply connector	Specifications
<b>2</b>	M12 (5 pins) B-coded	IN
<b>3</b>	7/8 inch (5 pins)	IN
<b>4</b>	M12 (4/5 pins) A-coded*1	IN/OUT
<b>5</b>	M12 (4/5 pins) A-coded*1	IN/OUT

\*1 The pin layout for the "4" and "5" pin connectors is different. Refer to the dimensions on page 22.

Mounting method

Symbol	Description	Note
<b>Nil</b>	Without DIN rail mounting bracket	—
<b>2</b>	With DIN rail mounting bracket	For SV, S0700, and VQC series
<b>3</b>	With DIN rail mounting bracket	For SY and JSY series

\* When the end plate (U side) is used, the symbol for the mounting method must be the same as the D side.

**Handheld Terminal EX600-HT1A - 3**

Handheld terminals are not yet UL-compliant.

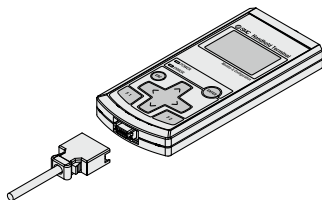

Version

Cable length

Symbol	Description
<b>Nil</b>	No cable
<b>1</b>	1 m
<b>3</b>	3 m

# EX600 Series

## Specifications

### All Units Common Specifications

Environment	Operating temperature range	Operating: -10 to 50°C, Stored: -20 to 60°C
	Operating humidity range	35 to 85% RH (No condensation)
	Withstand voltage*1	500 VAC for 1 minute between external terminals and FE
	Insulation resistance*1	500 VDC, 10 MΩ or more between external terminals and FE

\*1 Except handheld terminals

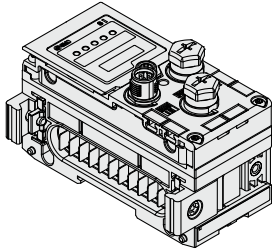

EX600-SPR□A

### SI Unit (EX600-SPR□A)

Model		EX600-SPR1A	EX600-SPR2A
Communication	Protocol	PROFIBUS DP (DP-V0)	
	Device type	PROFIBUS DP Slave	
	Communication speed	9.6/19.2/45.45/93.75/187.5/500 kbps 1.5/3/6/12 Mbps	
	Configuration file	GSD file*2	
	Occupation area (Number of inputs/outputs)	Max. (512 inputs/512 outputs)	
	Terminating resistor	Internally implemented	
Internal current consumption (Power supply for Control/Input)		80 mA or less	
Output	Output type	Source/PNP (Negative common)	Sink/NPN (Positive common)
	Number of outputs	32 outputs (8/16/24/32 outputs selectable)	
	Load	Solenoid valve with surge voltage suppressor 24 VDC, 1.5 W or less (SMC)	
	Power supply	24 VDC, 2 A	
	Fail safe	HOLD/CLEAR/Forced power ON	
	Protection	Short-circuit protection	
Enclosure		IP67 (Manifold assembly)	
Standards		CE marking (EMC directive/RoHS directive), UL (CSA)	
Weight		300 g	

\*2 The configuration file can be downloaded from the SMC website, <https://www.smcworld.com>

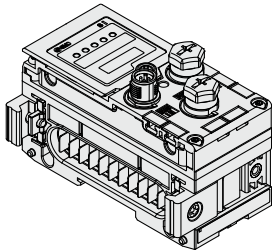

EX600-SDN□A

### SI Unit (EX600-SDN□A)

Model		EX600-SDN1A	EX600-SDN2A
Communication	Protocol	DeviceNet™: Volume 1 (Edition 2.1), Volume 3 (Edition 1.1)	
	Device type	Group 2 Only Server	
	Communication speed	125/250/500 kbps	
	Configuration file	EDS file*3	
	Occupation area (Number of inputs/outputs)	Max. (512 inputs/512 outputs)	
	Applicable messages	Duplicate MAC ID Check Message, Group 2 Only Unconnected Explicit Message Explicit Message (Group 2), Poll I/O Message (Predefined M/S Connection set)	
Applicable function		QuickConnect™	
DeviceNet™ power supply		11 to 25 VDC (Current consumption 50 mA or less)	
Internal current consumption (Power supply for Control/Input)		55 mA or less	
Output	Output type	Source/PNP (Negative common)	Sink/NPN (Positive common)
	Number of outputs	32 outputs (8/16/24/32 outputs selectable)	
	Load	Solenoid valve with surge voltage suppressor 24 VDC, 1.5 W or less (SMC)	
	Power supply	24 VDC, 2 A	
	Fail safe	HOLD/CLEAR/Forced power ON	
	Protection	Short-circuit protection	
Enclosure		IP67 (Manifold assembly)	
Standards		CE marking (EMC directive/RoHS directive), UL (CSA)	
Weight		300 g	

\*3 The configuration file can be downloaded from the SMC website, <https://www.smcworld.com>

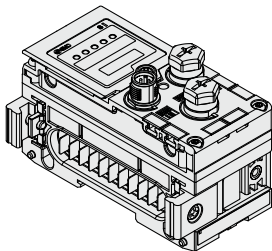

EX600-SMJ□

### SI Unit (EX600-SMJ□)

Model		EX600-SMJ1	EX600-SMJ2
Communication	Protocol	CC-Link (Ver. 1.10, Ver. 2.00)	
	Station type	Remote Device Station	
	Communication speed	156/625 kbps 2.5/5/10 Mbps	
	Configuration file	CSP+ file*4	
	Occupation area (Number of inputs/outputs)	Max. (512 inputs/512 outputs) 1/2/3/4 stations occupied	
	Internal current consumption (Power supply for Control/Input)		75 mA or less
Output	Output type	Source/PNP (Negative common)	Sink/NPN (Positive common)
	Number of outputs	32 outputs (8/16/24/32 outputs selectable)	
	Load	Solenoid valve with surge voltage suppressor 24 VDC, 1.5 W or less (SMC)	
	Power supply	24 VDC, 2 A	
	Fail safe	HOLD/CLEAR/Forced power ON	
	Protection	Short-circuit protection	
Enclosure		IP67 (Manifold assembly)	
Standards		CE marking (EMC directive/RoHS directive), UL (CSA)	
Weight		300 g	

\*4 The configuration file can be downloaded from the SMC website, <https://www.smcworld.com>



## Specifications

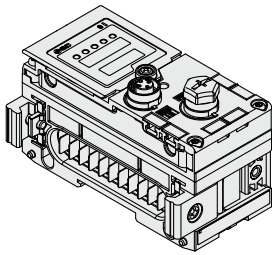

EX600-SEN1/2

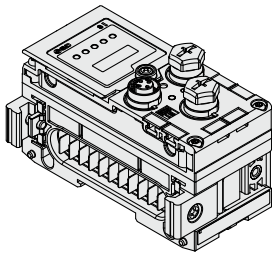

EX600-SEN3/4

### SI Unit (EX600-SEN□)

Model		EX600-SEN1	EX600-SEN2	EX600-SEN3	EX600-SEN4
Communication	Number of communication ports	1 port		2 ports	
	Protocol	EtherNet/IP™ (Conformance version: Composite 6)		EtherNet/IP™ (Conformance version: Composite 11)	
	Communication speed	10/100 Mbps			
	Communication method	Full duplex/Half duplex			
	Configuration file	EDS file*1			
	Occupation area (Number of inputs/outputs)	Max. (512 inputs/512 outputs)			
	IP address setting range	SI Unit switch settings: 192.168.0 or 1.1 to 254 Through DHCP server: Optional address			
	Device information	Vendor ID: 7 (SMC Corporation) Device type: 12 (Communication Adapter) Product code: 126		Vendor ID: 7 (SMC Corporation) Device type: 12 (Communication Adapter) Product code: 203	
	Applicable function	—		QuickConnect™ DLR Web server function	
	Internal current consumption (Power supply for Control/Input)	120 mA or less			
Output	Output type	Source/PNP (Negative common)	Sink/NPN (Positive common)	Source/PNP (Negative common)	Sink/NPN (Positive common)
	Number of outputs	32 outputs (8/16/24/32 outputs selectable)		32 outputs	
	Load	Solenoid valve with surge voltage suppressor 24 VDC, 1.5 W or less (SMC)		Solenoid valve with surge voltage suppressor 24 VDC, 1.0 W or less (SMC)	
	Power supply	24 VDC, 2 A			
	Fail safe	HOLD/CLEAR/Forced power ON			
	Protection	Short-circuit protection			
Enclosure	IP67 (Manifold assembly)				
Standards	CE marking (EMC directive/RoHS directive), UL (CSA)				
Weight	300 g				

\*1 The configuration file can be downloaded from the SMC website, <https://www.smcworld.com>

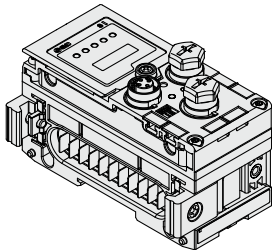

EX600-SEC□

### SI Unit (EX600-SEC□)

Model		EX600-SEC1	EX600-SEC2
Communication	Protocol	EtherCAT® (Conformance Test Record V.1.2)	
	Communication speed	100 Mbps	
	Configuration file	XML file*2	
	Occupation area (Number of inputs/outputs)	Max. (512 inputs/512 outputs)	
	Internal current consumption (Power supply for Control/Input)	100 mA or less	
Output	Output type	Source/PNP (Negative common)	Sink/NPN (Positive common)
	Number of outputs	32 outputs (8/16/24/32 outputs selectable)	
	Load	Solenoid valve with surge voltage suppressor 24 VDC, 1.5 W or less (SMC)	
	Power supply	24 VDC, 2 A	
	Fail safe	HOLD/CLEAR/Forced power ON	
	Protection	Short-circuit protection	
Enclosure	IP67 (Manifold assembly)		
Standards	CE marking (EMC directive/RoHS directive), UL (CSA)		
Weight	300 g		

\*2 The configuration file can be downloaded from the SMC website, <https://www.smcworld.com>

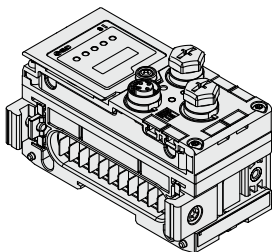

EX600-SPN□

### SI Unit (EX600-SPN□)

Model		EX600-SPN1	EX600-SPN2
Communication	Protocol	PROFINET IO (PROFINET RT)	
	Communication speed	100 Mbps	
	Configuration file	GSDML file*3	
	Occupation area (Number of inputs/outputs)	Max. (512 inputs/512 outputs)	
	Applicable function	Fast Start Up	
	Internal current consumption (Power supply for Control/Input)	120 mA or less	
Output	Output type	Source/PNP (Negative common)	Sink/NPN (Positive common)
	Number of outputs	32 outputs	
	Load	Solenoid valve with surge voltage suppressor 24 VDC, 1.0 W or less (SMC)	
	Power supply	24 VDC, 2 A	
	Fail safe	HOLD/CLEAR/Forced power ON	
	Protection	Short-circuit protection	
Enclosure	IP67 (Manifold assembly)		
Standards	CE marking (EMC directive/RoHS directive), UL (CSA)		
Weight	300 g		

\*3 The configuration file can be downloaded from the SMC website, <https://www.smcworld.com>

# EX600 Series

## Specifications

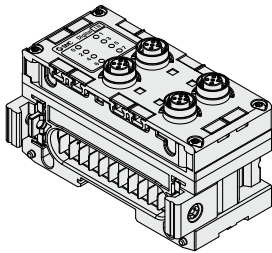

EX600-DX□B

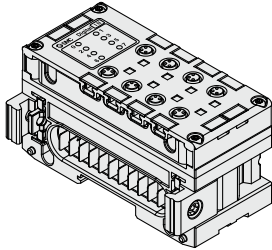

EX600-DX□C

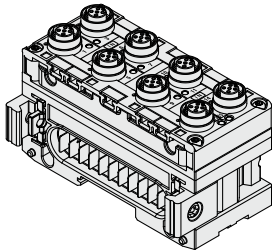

EX600-DX□D

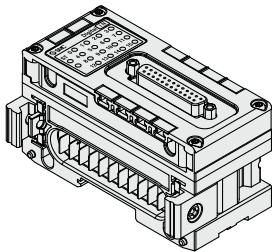

EX600-DX□E

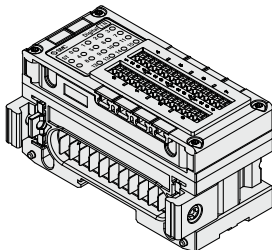

EX600-DX□F

### Digital Input Unit

Model		EX600-DXPB	EX600-DXNB	EX600-DXPC□	EX600-DXNC□	EX600-DXPD	EX600-DXND
Input	Input type	PNP	NPN	PNP	NPN	PNP	NPN
	Input connector	M12 (5-pin) socket*1		M8 (3-pin) socket*3		M12 (5-pin) socket*1	
	Number of inputs	8 inputs (2 inputs/Connector)		8 inputs (1 input/Connector)		16 inputs (2 inputs/Connector)	
	Supplied voltage	24 VDC					
	Max. supplied current	0.5 A/Connector 2 A/Unit		0.25 A/Connector 2 A/Unit		0.5 A/Connector 2 A/Unit	
	Protection	Short-circuit protection					
	Input current (at 24 VDC)	9 mA or less					
	ON voltage	17 V or more (At NPN input, between the pin for input terminal and supplied voltage of +24 V) (At PNP input, between the pin for input terminal and supplied voltage of 0 V)					
	OFF voltage	5 V or less (At NPN input, between the pin for input terminal and supplied voltage of +24 V) (At PNP input, between the pin for input terminal and supplied voltage of 0 V)					
	Open circuit detection current	2 wires	—		0.5 mA/Input*2		—
3 wires		—		0.5 mA/Connector*2		—	
Current consumption	50 mA or less		55 mA or less		70 mA or less		
Enclosure	IP67 (Manifold assembly)						
Standards	CE marking (EMC directive/RoHS directive), UL (CSA)						
Weight	300 g		275 g		340 g		

\*1 M12 (4-pin) connector can be connected.

\*2 Function only applies to the EX600-DX□C1.

\*3 When connecting the M8 plug connector, the tightening torque must be 0.2 N·m  $\pm$ 10%. If tightened with an excessive tightening torque, this may cause the connector thread of the unit to break.

Model		EX600-DXPE	EX600-DXNE	EX600-DXPF	EX600-DXNF
Input	Input type	PNP	NPN	PNP	NPN
	Input connector	D-sub socket (25 pins) Lock screw: No.4-40 UNC		Spring type terminal block (32 pins)	
	Number of inputs	16 inputs		16 inputs (2 inputs x 8 blocks)	
	Supplied voltage	24 VDC			
	Max. supplied current	2 A/Unit		0.5 A/Block 2 A/Unit	
	Protection	Short-circuit protection			
	Input current (at 24 VDC)	5 mA or less			
	ON voltage	17 V or more (At NPN input, between the pin for input terminal and supplied voltage of +24 V) (At PNP input, between the pin for input terminal and supplied voltage of 0 V)			
	OFF voltage	5 V or less (At NPN input, between the pin for input terminal and supplied voltage of +24 V) (At PNP input, between the pin for input terminal and supplied voltage of 0 V)			
	Applicable wire	—		0.08 to 1.5 mm <sup>2</sup> (AWG16 to 28)	
Current consumption	50 mA or less		55 mA or less		
Enclosure	IP40 (Manifold assembly)				
Standards	CE marking (EMC directive/RoHS directive), UL (CSA)				
Weight	300 g				

## Specifications

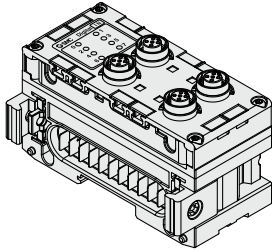

EX600-DY□B

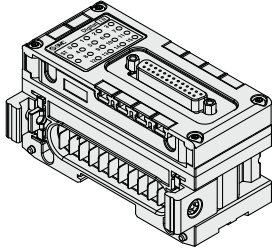

EX600-DY□E  
EX600-DM□E

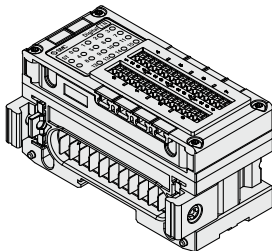

EX600-DY□F  
EX600-DM□F

### Digital Output Unit

Model	EX600-DYPB	EX600-DYNB	EX600-DYPE	EX600-DYNE	EX600-DYPF	EX600-DYNF
<b>Output type</b>	PNP	NPN	PNP	NPN	PNP	NPN
<b>Output connector</b>	M12 (5-pin) socket*1		D-sub socket (25 pins) Lock screw: No.4-40 UNC		Spring type terminal block (32 pins)	
<b>Number of outputs</b>	8 outputs (2 outputs/Connector)		16 outputs		16 outputs (2 outputs x 8 blocks)	
<b>Supplied voltage</b>	24 VDC					
<b>Max. load current</b>	0.5 A/Output 2 A/Unit					
<b>Protection</b>	Short-circuit protection					
<b>Applicable wire</b>	—		—		0.08 to 1.5 mm <sup>2</sup> (AWG16 to 28)	
<b>Current consumption</b>	50 mA or less					
<b>Enclosure</b>	IP67 (Manifold assembly)		IP40 (Manifold assembly)			
<b>Standards</b>	CE marking (EMC directive/RoHS directive), UL (CSA)					
<b>Weight</b>	300 g					

\*1 M12 (4-pin) connector can be connected.

### Digital Input/Output Unit

Model	EX600-DMPE	EX600-DMNE	EX600-DMPF	EX600-DMNF
<b>Input/Output type</b>	PNP	NPN	PNP	NPN
<b>Connector</b>	D-sub socket (25 pins) Lock screw: No.4-40 UNC		Spring type terminal block (32 pins)	
<b>Number of inputs</b>	8 inputs		8 inputs (2 inputs x 4 blocks)	
<b>Supplied voltage</b>	24 VDC			
<b>Max. supplied current</b>	2 A/Unit		0.5 A/Block 2 A/Unit	
<b>Protection</b>	Short-circuit protection			
<b>Input current (at 24 VDC)</b>	5 mA or less			
<b>ON voltage</b>	17 V or more (At NPN input, between the pin for input terminal and supplied voltage of +24 V) (At PNP input, between the pin for input terminal and supplied voltage of 0 V)			
<b>OFF voltage</b>	5 V or less (At NPN input, between the pin for input terminal and supplied voltage of +24 V) (At PNP input, between the pin for input terminal and supplied voltage of 0 V)			
<b>Number of outputs</b>	8 outputs		8 outputs (2 outputs x 4 blocks)	
<b>Supplied voltage</b>	24 VDC			
<b>Max. load current</b>	0.5 A/Output 2 A/Unit			
<b>Protection</b>	Short-circuit protection			
<b>Applicable wire</b>	—		0.08 to 1.5 mm <sup>2</sup> (AWG16 to 28)	
<b>Current consumption</b>	50 mA or less		60 mA or less	
<b>Enclosure</b>	IP40 (Manifold assembly)			
<b>Standards</b>	CE marking (EMC directive/RoHS directive), UL (CSA)			
<b>Weight</b>	300 g			

# EX600 Series

## Specifications

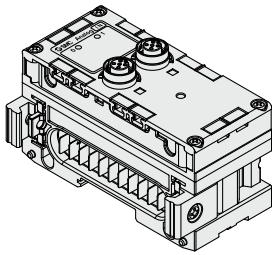

EX600-AXA

### Analog Input Unit

Model		EX600-AXA		
Input	Input type	Voltage input	Current input	
	Input connector	M12 (5-pin) socket*1		
	Input channel	2 channels (1 channel/Connector)		
	Supplied voltage	24 VDC		
	Max. supplied current	0.5 A/Connector		
	Protection	Short-circuit protection		
	Input signal range	12 bit resolution	0 to 10 V, 1 to 5 V, 0 to 5 V	0 to 20 mA, 4 to 20 mA
		16 bit resolution	-10 to 10 V, -5 to 5 V	-20 to 20 mA
	Max. rated input signal	±15 V	±22 mA*2	
	Input impedance	100 kΩ	50 Ω	
	Linearity (25°C)	±0.05% F.S.		
	Repeatability (25°C)	±0.15% F.S.		
	Absolute accuracy (25°C)	±0.5% F.S.	±0.6% F.S.	
	Current consumption	70 mA or less		
Enclosure	IP67 (Manifold assembly)			
Standards	CE marking (EMC directive/RoHS directive), UL (CSA)			
Weight	290 g			

\*1 M12 (4-pin) connector can be connected.

\*2 When input signal exceeds 22 mA, the protection function activates and the input signal is interrupted.

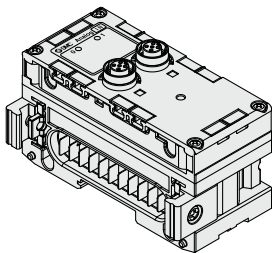

EX600-AYA

### Analog Output Unit

Model		EX600-AYA		
Output	Output type	Voltage output	Current output	
	Output connector	M12 (5-pin) socket*3		
	Output channel	2 channels (1 channel/Connector)		
	Supplied voltage	24 VDC		
	Max. load current	0.5 A/Connector		
	Protection	Short-circuit protection		
	Output signal range	12 bit resolution	0 to 10 V, 1 to 5 V, 0 to 5 V	0 to 20 mA, 4 to 20 mA
		16 bit resolution	-10 to 10 V, -5 to 5 V	-20 to 20 mA
	Load impedance	1 kΩ or more	600 Ω or less	
	Linearity (25°C)	±0.05% F.S.		
	Repeatability (25°C)	±0.15% F.S.		
	Absolute accuracy (25°C)	±0.5% F.S.	±0.6% F.S.	
	Current consumption	70 mA or less		
	Enclosure	IP67 (Manifold assembly)		
Standards	CE marking (EMC directive/RoHS directive), UL (CSA)			
Weight	290 g			

\*3 M12 (4-pin) connector can be connected.

## Specifications

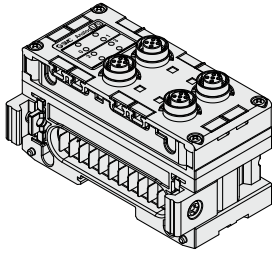

**EX600-AMB**

### Analog Input/Output Unit

Model		<b>EX600-AMB</b>		
<b>Input type</b>		Voltage input	Current input	
<b>Input connector</b>		M12 (5-pin) socket*1		
<b>Input channel</b>		2 channels (1 channel/Connector)		
<b>Supplied voltage</b>		24 VDC		
<b>Max. supplied current</b>		0.5 A/Connector		
<b>Protection</b>		Short-circuit protection		
<b>Input</b>	<b>Input signal range</b>	12 bit resolution	0 to 10 V, 1 to 5 V, 0 to 5 V	
			0 to 20 mA, 4 to 20 mA	
	<b>Max. rated input signal</b>		15 V	
			22 mA*2	
	<b>Input impedance</b>		100 kΩ	
			250 Ω	
	<b>Linearity (25°C)</b>		±0.05% F.S.	
<b>Repeatability (25°C)</b>		±0.15% F.S.		
<b>Absolute accuracy (25°C)</b>		±0.5% F.S.	±0.6% F.S.	
<b>Output type</b>		Voltage output	Current output	
<b>Output connector</b>		M12 (5-pin) socket*1		
<b>Output channel</b>		2 channels (1 channel/Connector)		
<b>Supplied voltage</b>		24 VDC		
<b>Max. load current</b>		0.5 A/Connector		
<b>Protection</b>		Short-circuit protection		
<b>Output</b>	<b>Output signal range</b>	12 bit resolution	0 to 10 V, 1 to 5 V, 0 to 5 V	
			0 to 20 mA, 4 to 20 mA	
	<b>Load impedance</b>		1 kΩ or more	
			600 Ω or less	
	<b>Linearity (25°C)</b>		±0.05% F.S.	
	<b>Repeatability (25°C)</b>		±0.15% F.S.	
	<b>Absolute accuracy (25°C)</b>		±0.5% F.S.	±0.6% F.S.
<b>Current consumption</b>		100 mA or less		
<b>Enclosure</b>		IP67 (Manifold assembly)		
<b>Standards</b>		CE marking (EMC directive/RoHS directive), UL (CSA)		
<b>Weight</b>		300 g		

\*1 M12 (4-pin) connector can be connected.

\*2 When input signal exceeds 22 mA, the protection function activates and the input signal is interrupted.

# EX600 Series

## Specifications

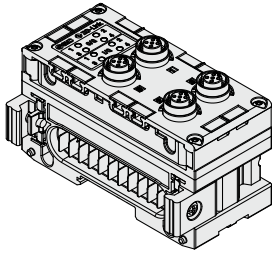

EX600-L□B1

### IO-Link Master Unit

Model		EX600-LAB1	EX600-LBB1
IO-Link version		Version 1.1	
IO-Link port class		Class A	Class B
Communication speed		COM1 (4.8 kBaud) COM2 (38.4 kBaud) COM3 (230.4 kBaud) * Changes automatically according to the connected device	
Number of IO-Link ports		4	
Compatible SI unit (Protocol)		EX600-SEN3-X80 (EtherNet/IP™)	
Max. supply current	Device power supply (L+)	0.5 A/Connector (2 A/Unit)	0.5 A/Connector (1 A/Unit)
	External power supply (P24)	—	1.6 A/Connector (3 A/Unit)
Input	Pin no.	2	4
	Input type	PNP	
	Protection	Short-circuit protection	
	Rated input current	Approx. 2.5 mA	Approx. 5.8 mA
	ON voltage	13 V or more	
Output	Pin no.	4	
	Output type	PNP	
	Max. load current (C/Q line)	0.25 A/Output (Supplied from the power supply for control/input)	
	Protection	Short-circuit protection	
	Current consumption	50 mA or less	
Enclosure		IP67 (Manifold assembly)	
Standards		CE marking (EMC directive/RoHS directive), UL (CSA)	
Weight		320 g	

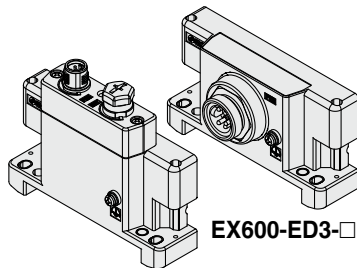

EX600-ED2/4/5-□

### End Plate

Model		EX600-ED2-□	EX600-ED3-□	EX600-ED4/5-□
Power supply connector	PWR IN	M12 (5-pin) plug	7/8 inch (5-pin) plug	M12 (4-pin) plug
	PWR OUT	—	—	M12 (5-pin) socket
Rated voltage	Power supply for control/input	24 VDC ±10%		
	Power supply for output	24 VDC +10/-5%		
Rated current	Power supply for control/input	Max. 2 A	Max. 8 A	Max. 4 A
	Power supply for output			
Enclosure		IP67 (Manifold assembly)		
Standards*1		CE marking (EMC directive/RoHS directive), UL (CSA)		
Weight		170 g	175 g	170 g

\*1 The EX600-ED4/5-□ is not compliant with UL (CSA) standards.

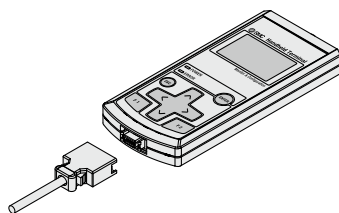

EX600-HT1A-□

### Handheld Terminal

Model	EX600-HT1A-□
Power supply	Power supplied from SI unit connector (24 VDC)
Current consumption	50 mA or less
Display	LCD with backlight
Connection cable	Handheld terminal cable (1 m ... EX600-AC010-1, 3 m ... EX600-AC030-1)
Enclosure	IP20
Standards*1	CE marking (EMC directive/RoHS directive)
Weight	160 g

\*1 The handheld terminal is not compliant with UL (CSA) standards.

## Dimensions

### SI Unit

EX600-SPR□A  
EX600-SDN□A  
EX600-SMJ□

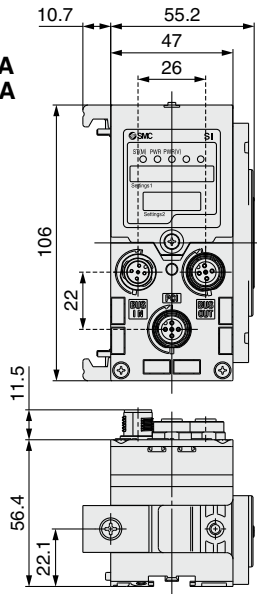

EX600-SEN□  
EX600-SEC□  
EX600-SPN□

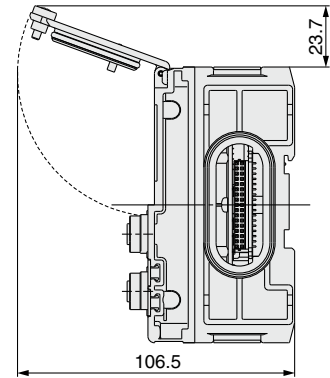
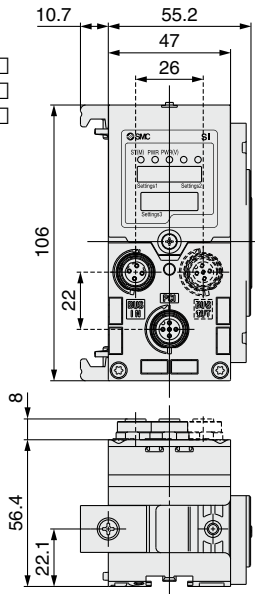

### End Plate (D side)

#### EX600-ED2/ED4/ED5

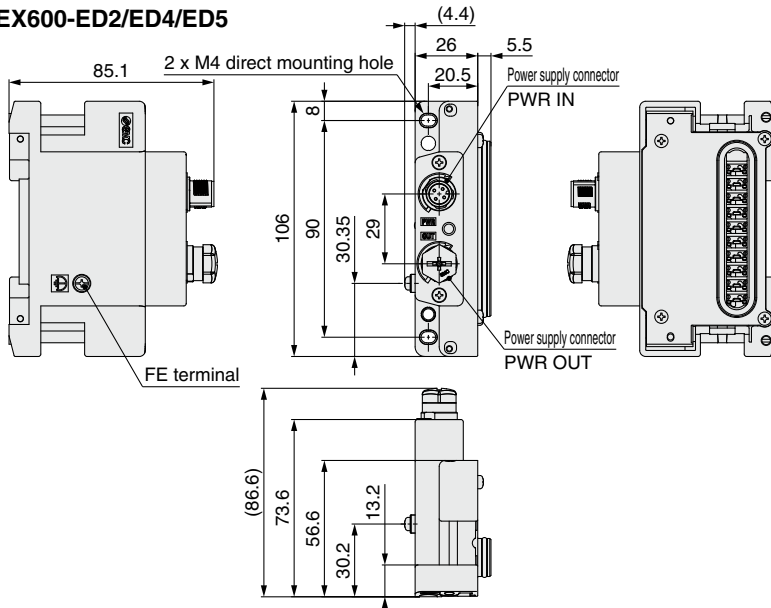

#### EX600-ED2

##### Power supply connector PWR IN: M12 5-pin plug, B-coded

Configuration	Pin no.	Description
	1	24 V (for output)
	2	0 V (for output)
	3	24 V (for control/input)
	4	0 V (for control/input)
	5	FE

##### Power supply connector PWR IN: M12 4-pin plug, A-coded

Configuration	EX600-ED4 (Pin arrangement 1)		EX600-ED5 (Pin arrangement 2)	
	Pin no.	Description	Pin no.	Description
	1	24 V (for control/input)	1	24 V (for output)
	2	24 V (for output)	2	0 V (for output)
	3	0 V (for control/input)	3	24 V (for control/input)
	4	0 V (for output)	4	0 V (for control/input)

##### Power supply connector PWR OUT: M12 5-pin socket, A-coded

Configuration	EX600-ED4 (Pin arrangement 1)		EX600-ED5 (Pin arrangement 2)	
	Pin no.	Description	Pin no.	Description
	1	24 V (for control/input)	1	24 V (for output)
	2	24 V (for output)	2	0 V (for output)
	3	0 V (for control/input)	3	24 V (for control/input)
	4	0 V (for output)	4	0 V (for control/input)
	5	Unused	5	Unused

#### EX600-ED3

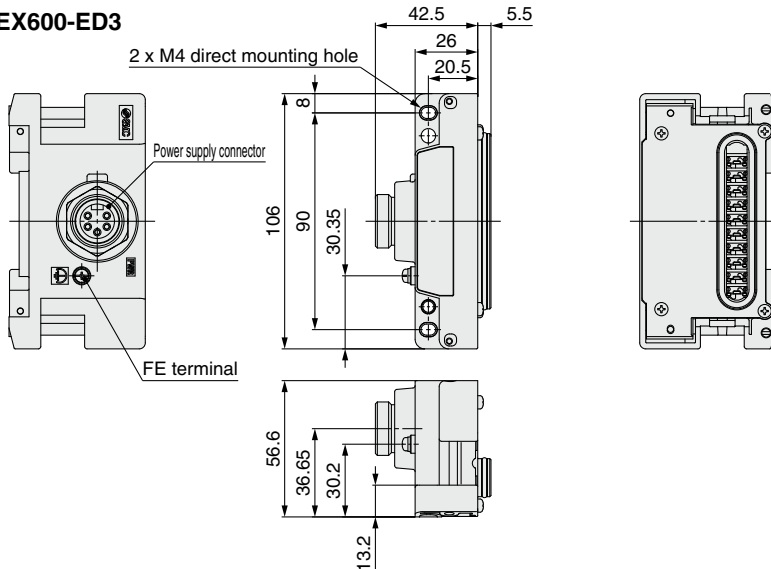

##### Power supply connector PWR: 7/8 inch 5-pin plug

Configuration	Pin no.	Description
	1	0 V (for output)
	2	0 V (for control/input)
	3	FE
	4	24 V (for control/input)
	5	24 V (for output)

# EX600 Series

## Dimensions

### Digital Unit

EX600-DX□B  
EX600-DY□B

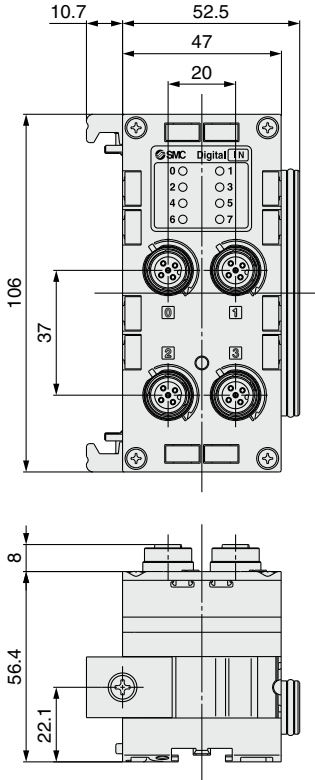

EX600-DX□C

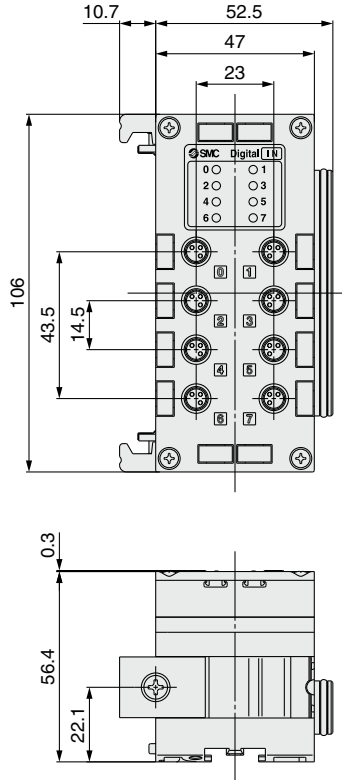

EX600-DX□D

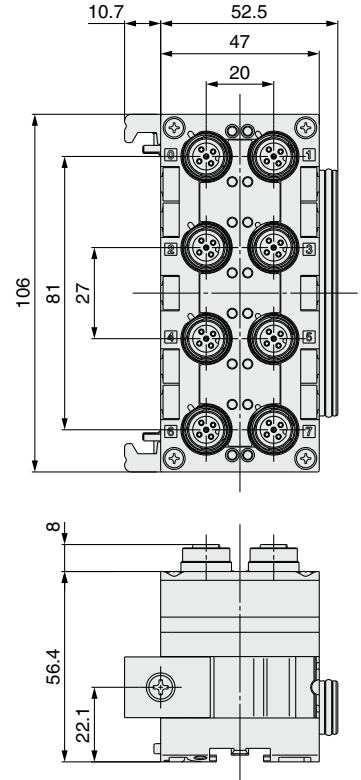

EX600-DX□E  
EX600-DY□E  
EX600-DM□E

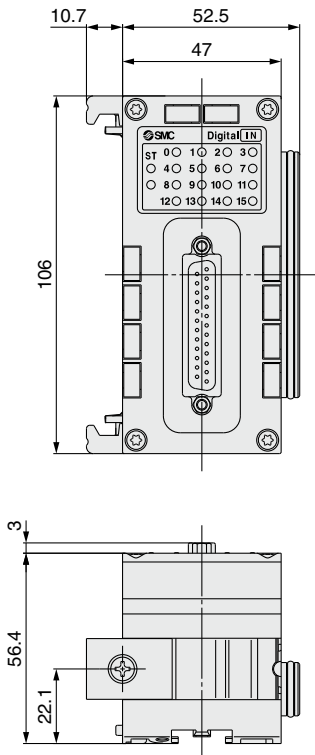

EX600-DX□F  
EX600-DY□F  
EX600-DM□F

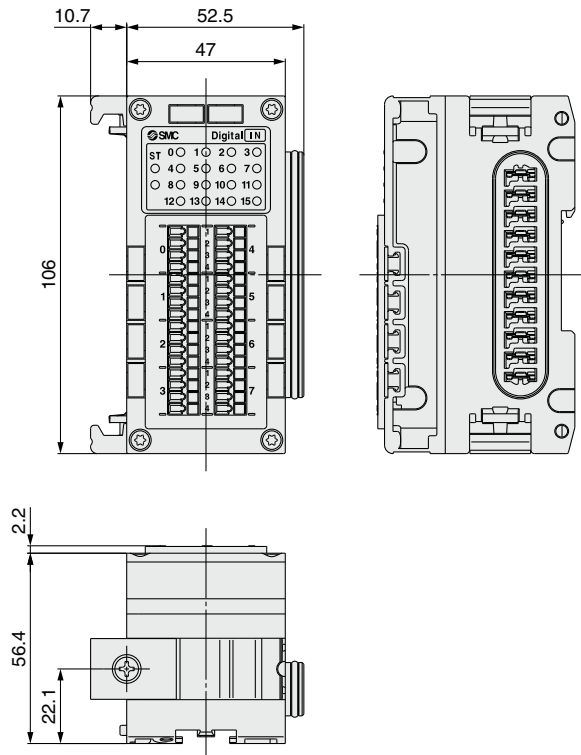



## Dimensions

### Analog Unit

EX600-AXA  
EX600-AYA

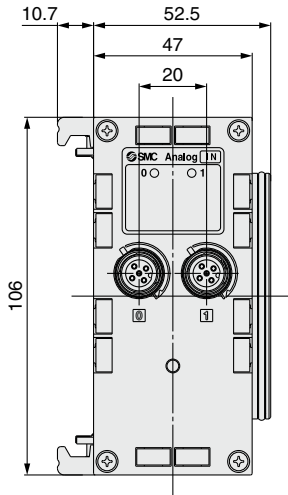

EX600-AMB

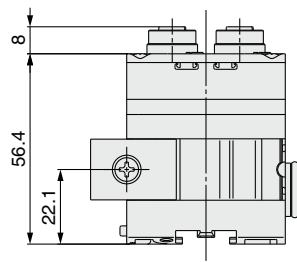
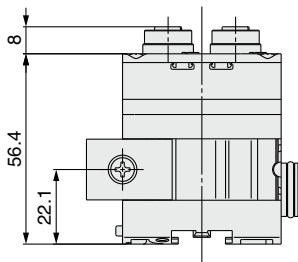
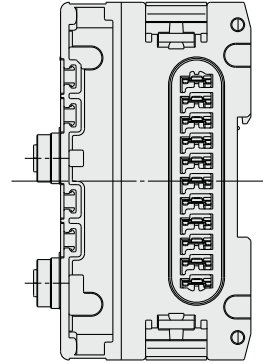
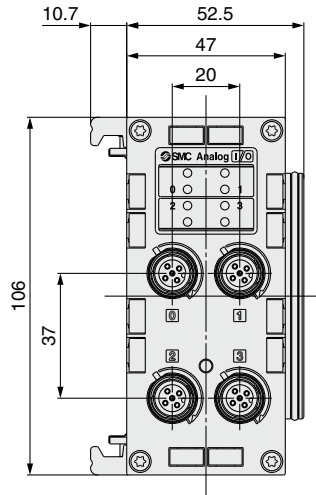

### IO-Link Master Unit

EX600-LAB1  
EX600-LBB1

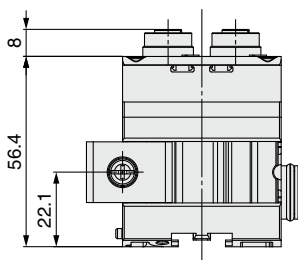
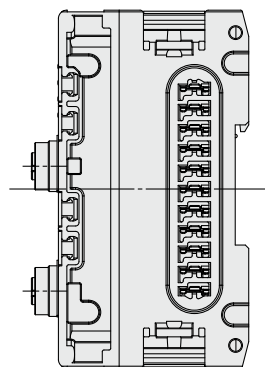
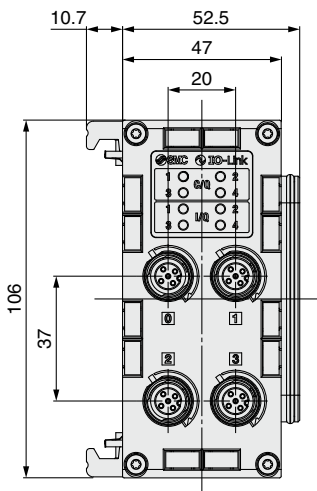

# EX600 Series

## Parts Description

### SI Unit

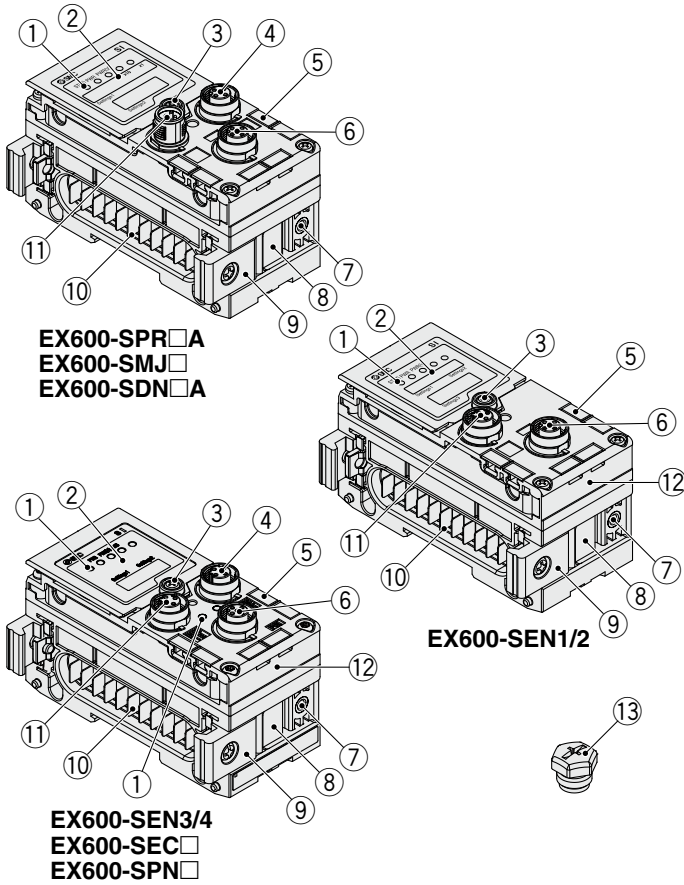

No.	Name	Use
1	Status indication LED	Displays unit status
2	Indication cover	Open for setting the switch.
3	Indication cover set screw	Loosen for opening the indication cover.
4	Connector (BUS OUT)	Connects to the fieldbus output cable (SPEEDCON)
5	Marker groove	Can be used to mount a marker
6	Connector (PCI)	Connects to the handheld terminal cable (SPEEDCON)
7	Valve plate mounting holes	Fixes a valve plate in place
8	Valve plate mounting groove	Inserts a valve plate
9	Joint bracket	Links units to one another
10	Connector for unit (Plug)	Transmits signals to the neighboring unit and supplies power
11	Connector (BUS IN)	Connects to the cable for fieldbus input (SPEEDCON)
12	MAC address name plate*1	Displays a unique 12-digit MAC address for each SI unit
13	Seal cap	Mounted on the connectors (BUS OUT and PCI) at the time of shipment

\*1 MAC address name plate is not provided on the EX600-SEC□.

### Digital Unit

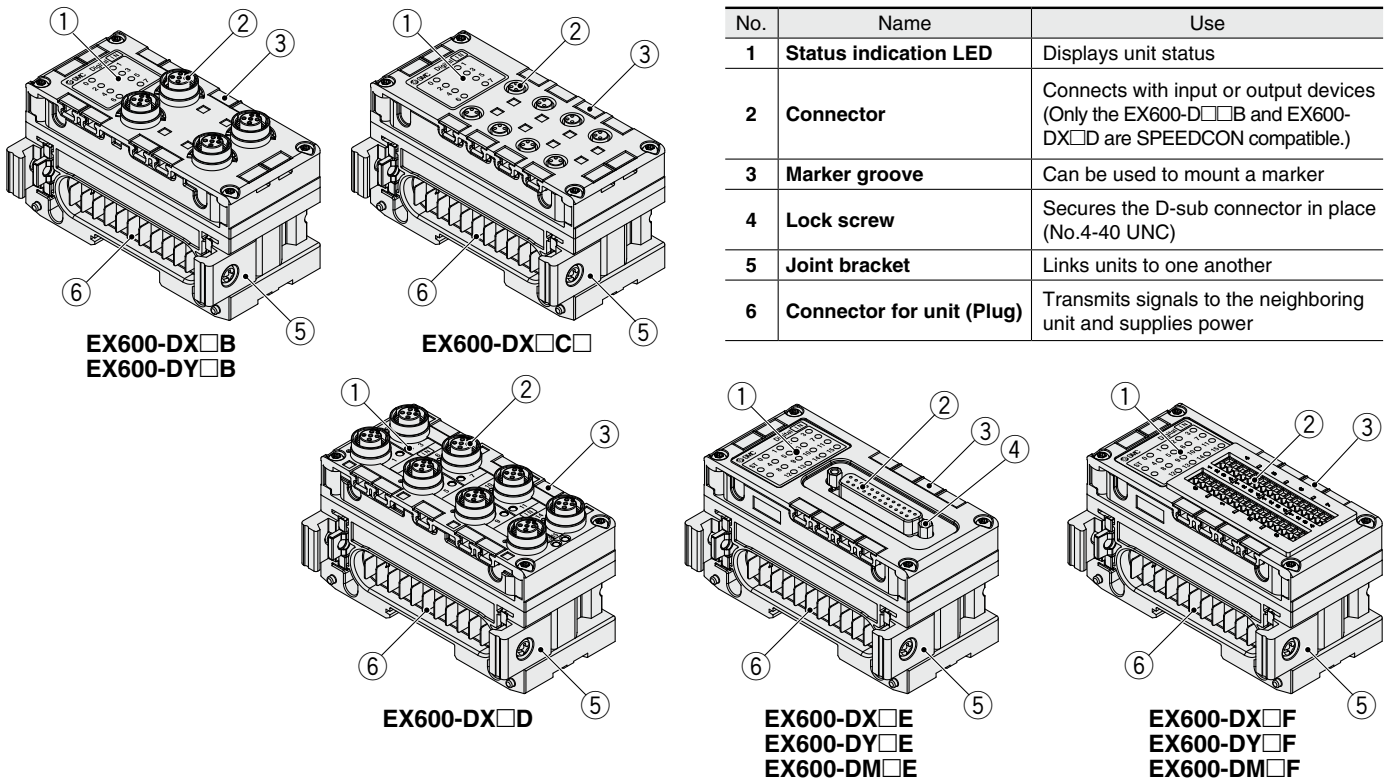

No.	Name	Use
1	Status indication LED	Displays unit status
2	Connector	Connects with input or output devices (Only the EX600-D□□B and EX600-DX□□ are SPEEDCON compatible.)
3	Marker groove	Can be used to mount a marker
4	Lock screw	Secures the D-sub connector in place (No.4-40 UNC)
5	Joint bracket	Links units to one another
6	Connector for unit (Plug)	Transmits signals to the neighboring unit and supplies power

## Parts Description

### Analog Unit

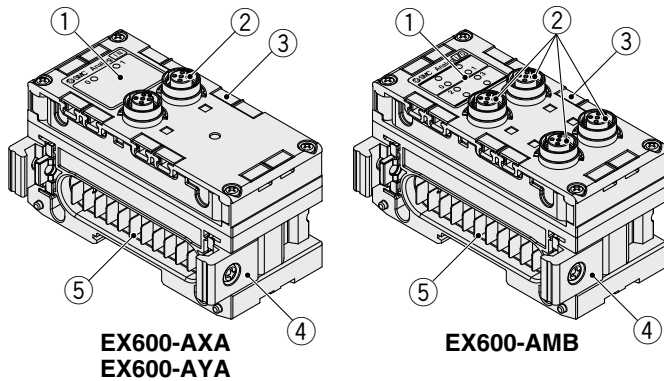

No.	Name	Use
1	<b>Status indication LED</b>	Displays unit status
2	<b>Connector</b>	Connects with input or output devices (SPEEDCON)
3	<b>Marker groove</b>	Can be used to mount a marker
4	<b>Joint bracket</b>	Links units to one another
5	<b>Connector for unit (Plug)</b>	Transmits signals to the neighboring unit and supplies power

### IO-Link Master Unit

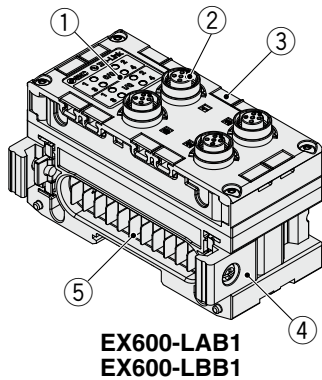

No.	Name	Use
1	<b>Status indication LED</b>	Displays unit status
2	<b>Connector</b>	Connects with IO-Link, input, or output devices (SPEEDCON)
3	<b>Marker groove</b>	Can be used to mount a marker
4	<b>Joint bracket</b>	Links units to one another
5	<b>Connector for unit (Plug)</b>	Transmits signals to the neighboring unit and supplies power

### End Plate

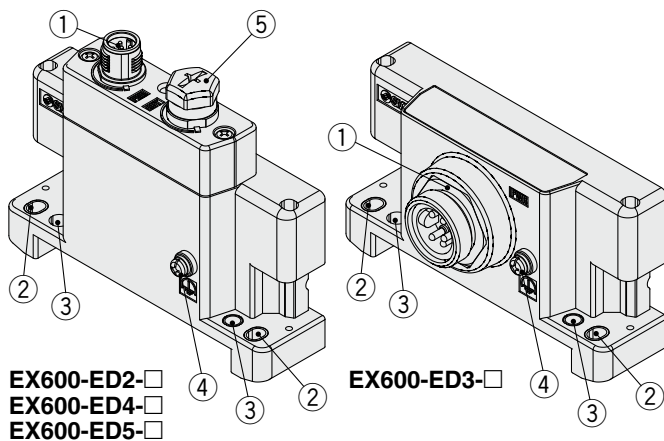

No.	Name	Use
1	<b>Power connector (PWR IN)</b>	Supplies power to the unit and/or input/output device (Only the EX600-ED2-□ is SPEEDCON compatible.)
2	<b>Fixing hole for direct mounting</b>	Connects directly to equipment
3	<b>Fixing hole for DIN rail</b>	Converts to manifold or for DIN rail mounting
4	<b>FE terminal</b>	Used for grounding Ground this terminal securely to improve noise immunity.
5	<b>EX600-ED2-□ Connector (Unused)</b> <b>EX600-ED4-□</b> <b>EX600-ED5-□ Power connector (PWR OUT)</b>	This connector has not yet been used. Do not remove the seal cap. Supplies power to the device on the downstream side

# EX600 Series

## LED Indicator

### EX600-SPR□A

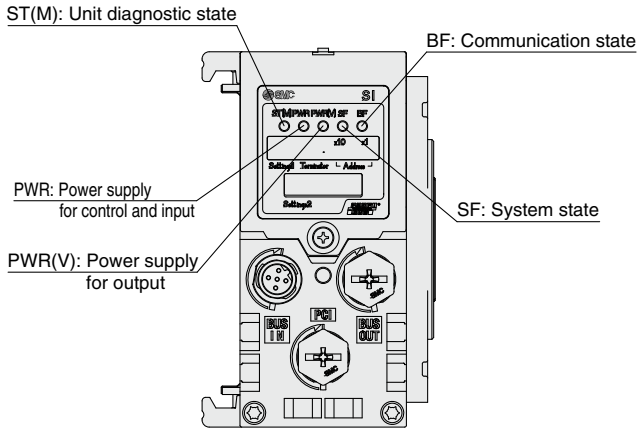

### EX600-SDN□A

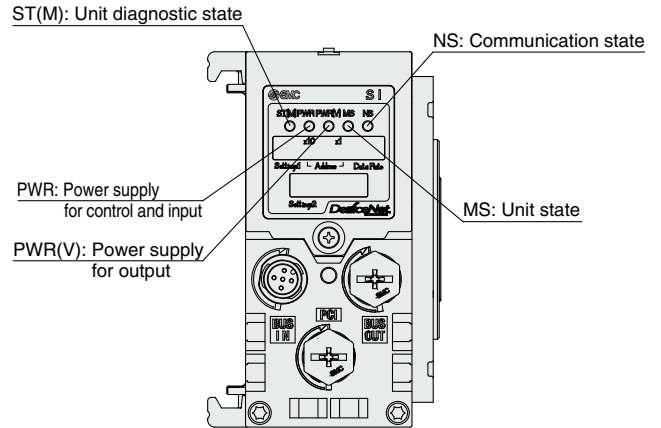

### EX600-SEN1/SEN2

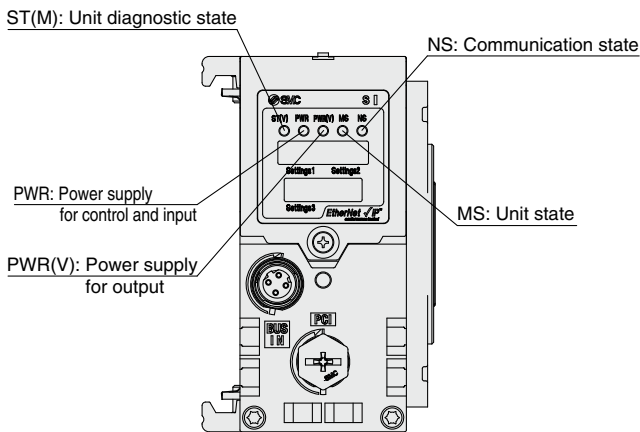

### EX600-SEN3/SEN4

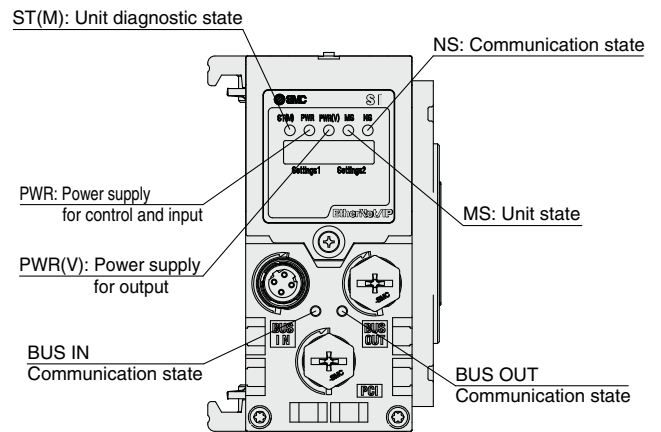

### EX600-SEC□

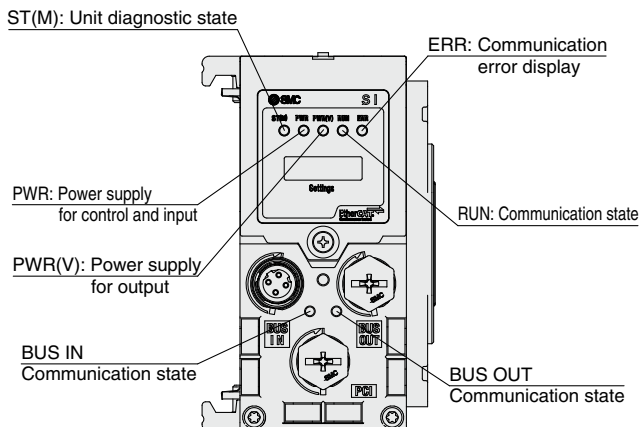

### EX600-SPN□

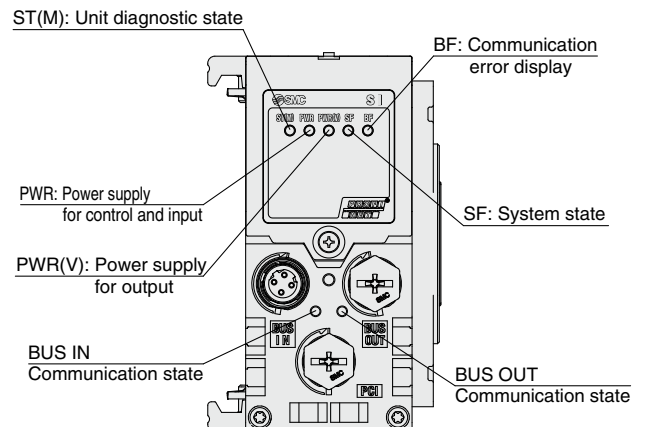

## LED Indicator

### EX600-SMJ□□

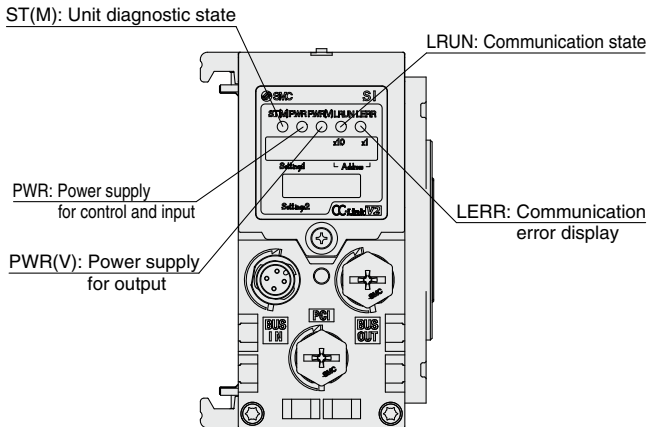

### EX600-DX□□B

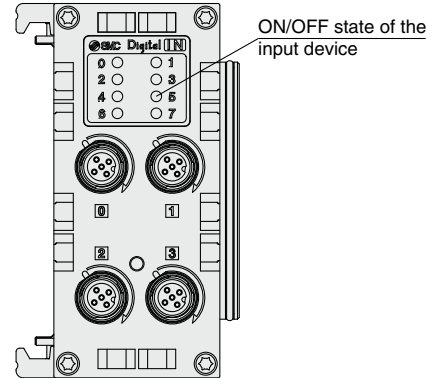

### EX600-DX□□C□

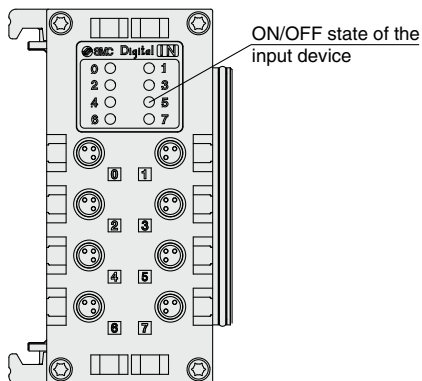

### EX600-DX□□D

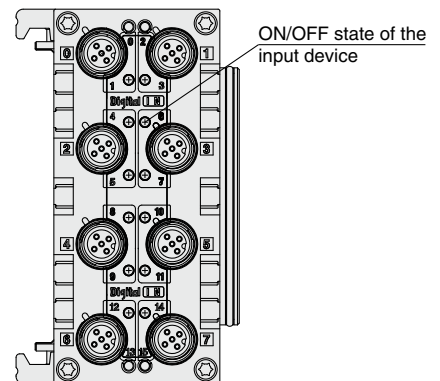

### EX600-DX□□E

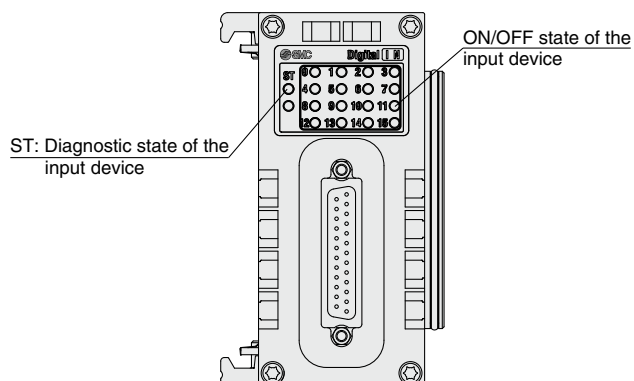

### EX600-DX□□F

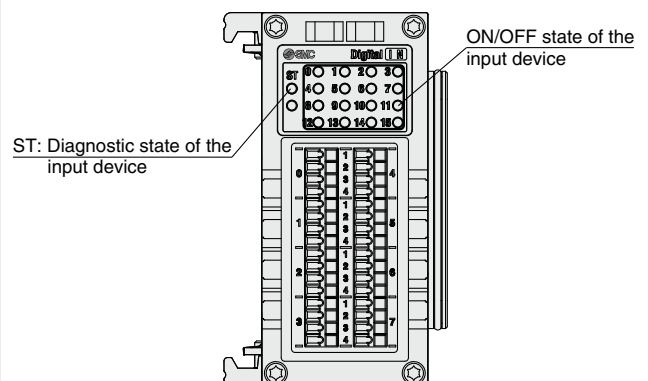

# EX600 Series

## LED Indicator

### EX600-DY□B

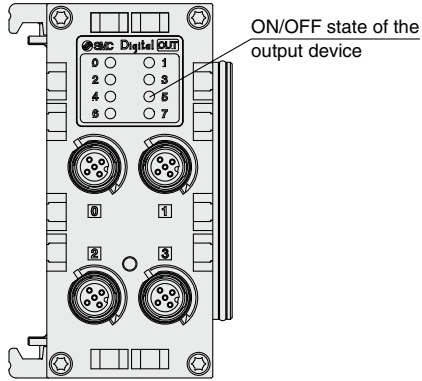

### EX600-DY□E

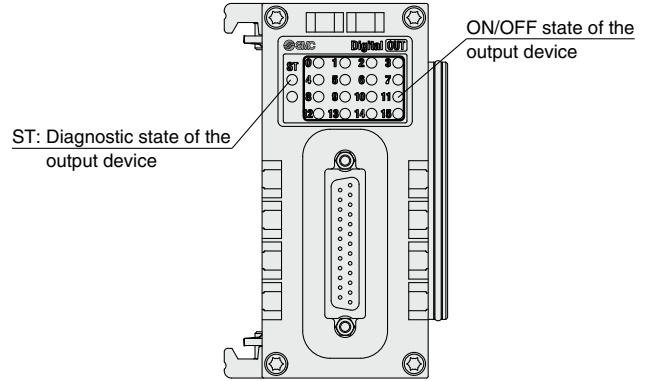

### EX600-DY□F

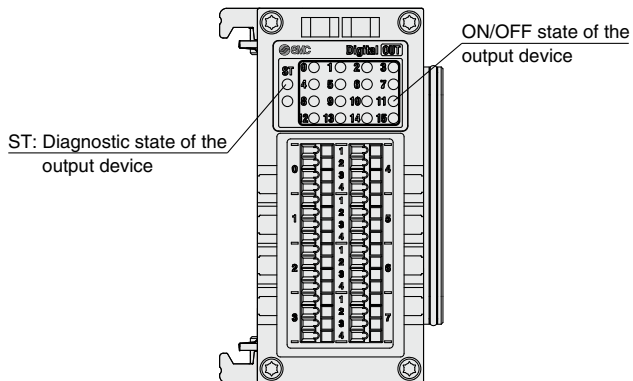

### EX600-DM□E

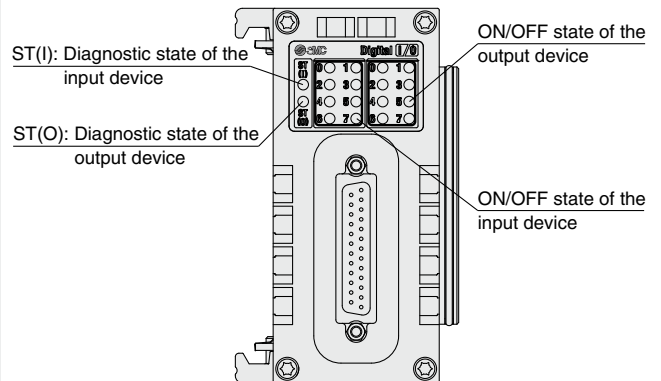

### EX600-DM□F

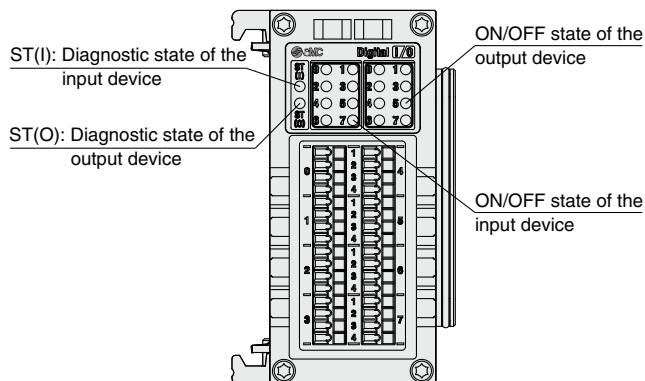

### EX600-AXA

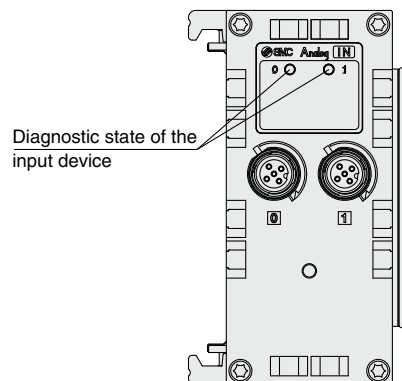

## LED Indicator

### EX600-AYA

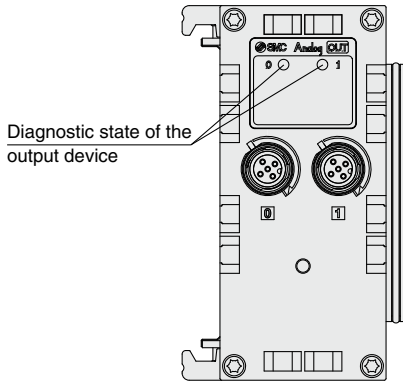

### EX600-AMB

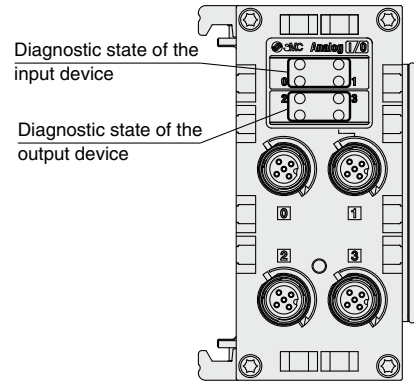

### EX600-LAB1

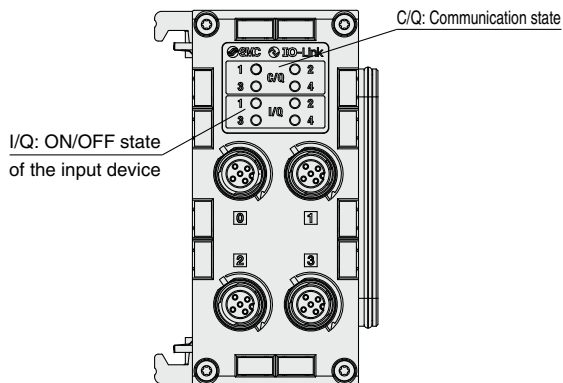

### EX600-LBB1

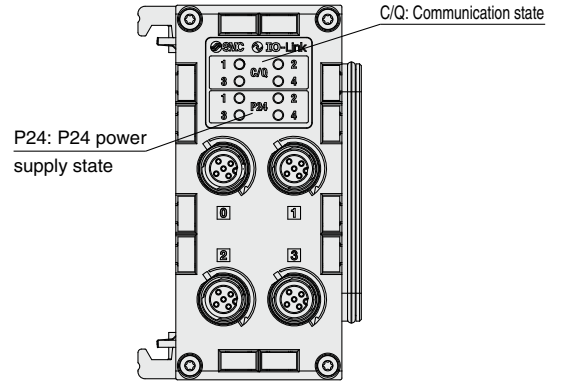

# EX600 Series Accessories

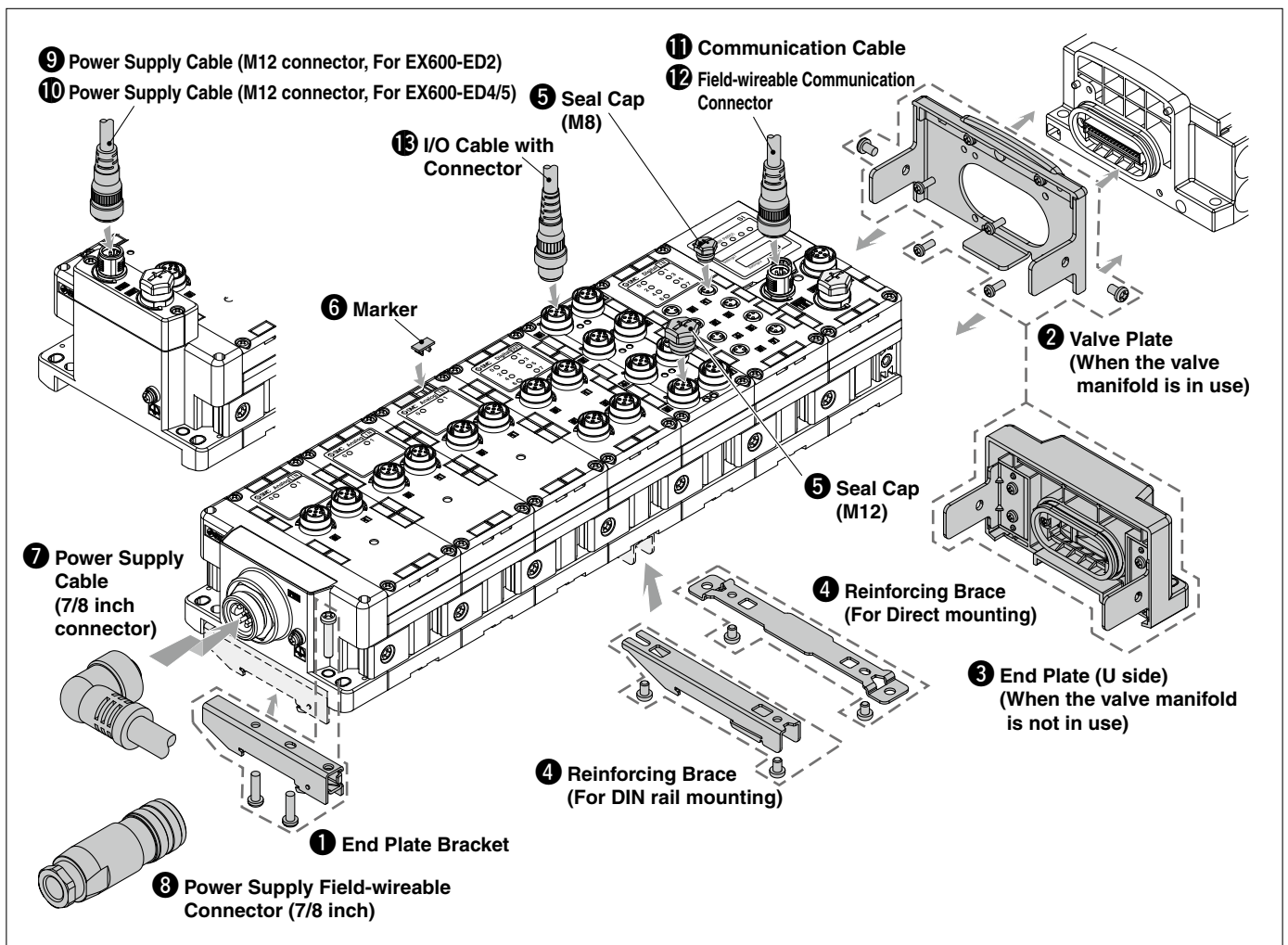

## 1 End Plate Bracket

This bracket is used for the end plate of DIN rail mounting.



### EX600-ZMA2

#### Enclosed parts

Round head screw (M4 x 20) 1 pc.  
P-tight screw (4 x 14) 2 pcs.

### EX600-ZMA3

(Specialized for SY series)

#### Enclosed parts

Round head screw with washer (M4 x 20) 1 pc.  
P-tight screw (4 x 14) 2 pcs.

## 2 Valve Plate

### EX600-ZMV1

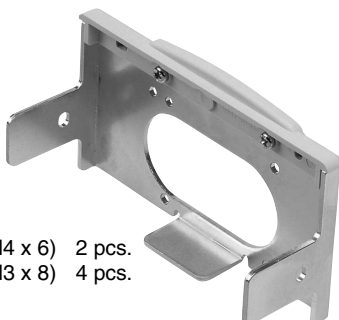

#### Enclosed parts

Round head screw (M4 x 6) 2 pcs.  
Round head screw (M3 x 8) 4 pcs.

### EX600-ZMV2

(Specialized for SY series)



#### Enclosed parts

Round head screw (M4 x 6) 2 pcs.  
Round head screw (M3 x 8) 2 pcs.



### ③ End Plate (U side)

The end plate is for use when the manifold valve is not connected.

EX600-**E U 1 - 2**

● **Mounting method**

Symbol	Description	Note
Nil	Without DIN rail mounting bracket	—
2	With DIN rail mounting bracket	For EX600-ED□-2
3	With DIN rail mounting bracket	For EX600-ED□-3

\* Select in accordance with the symbol for the end plate (D side) mounting method.

● **Specification**

Symbol	Specification
1	Waterproof cover

● **End plate mounting position: U side**

● **End plate**

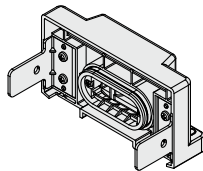

EX600-EU1

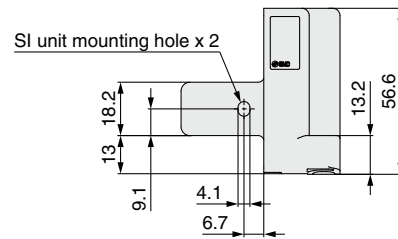
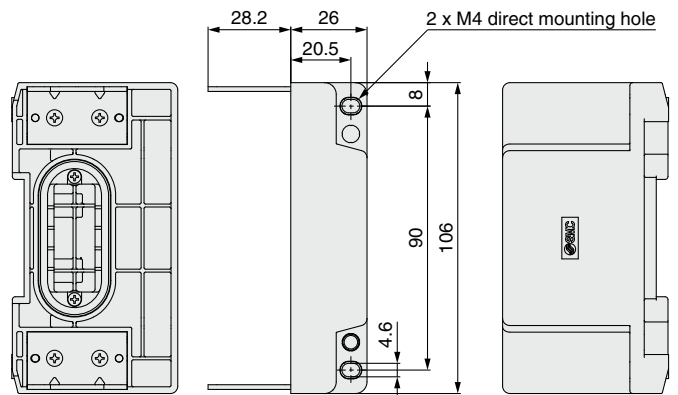

**Enclosed parts**

Round head screw (M4 x 5) 2 pcs.

### ④ Reinforcing Brace

This bracket is used on the bottom of the unit at the intermediate position for connecting 6 units or more.

\* Be sure to attach this bracket to prevent connection failure between the units caused by deflection.

For Direct mounting  
**EX600-ZMB1**



**Enclosed parts**

Round head screw (M4 x 5) 2 pcs.

For DIN rail mounting  
**EX600-ZMB2**

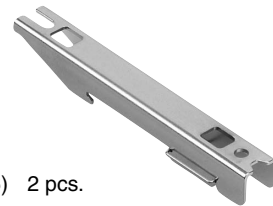

**Enclosed parts**

Round head screw (M4 x 6) 2 pcs.

### ⑤ Seal Cap (10 pcs.)

Be sure to mount a seal cap on any unused I/O connectors. Otherwise, the specified enclosure cannot be maintained.

**EX9-AWES**  
For M8



**EX9-AWTS**  
For M12



### ⑥ Marker (1 sheet, 88 pcs.)

The signal name of I/O device and each unit address can be entered and mounted on each unit.

**EX600-ZT1**

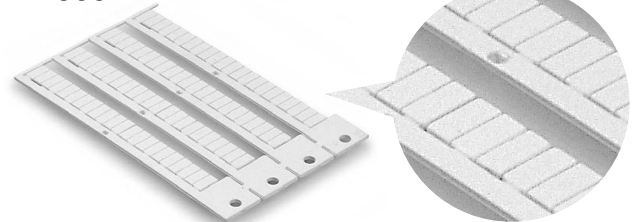

# EX600 Series

## ⑦ Power Supply Cable (7/8 inch connector)

- PCA-1558810 Straight 2 m
- PCA-1558823 Straight 6 m
- PCA-1558836 Right angled 2 m
- PCA-1558849 Right angled 6 m



### Straight connector type

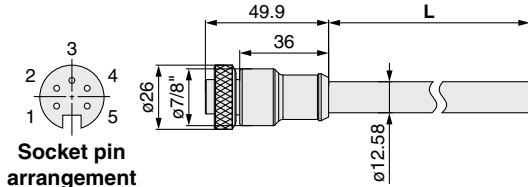

Socket pin arrangement

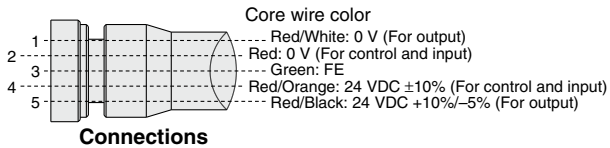

### Angled connector type

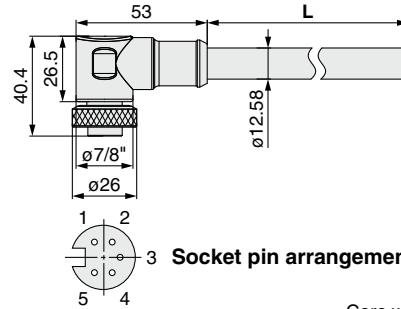

Socket pin arrangement

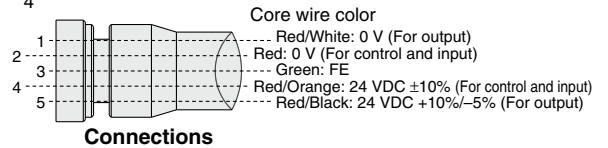

Item	Specifications
Cable O.D.	12.58 mm
Conductor nominal cross section	1.5 mm <sup>2</sup> /AWG16
Wire O.D. (Including insulator)	2.35 mm
Min. bending radius (Fixed)	110 mm

## ⑧ Power Supply Field-wireable Connector (7/8 inch)

- PCA-1578081 Socket [compatible with AWG22-16]



### Applicable Cable

Item	Specifications
Cable O.D.	12.0 to 14.0 mm
Wire gauge (Stranded wire cross section)	0.34 to 1.5 mm <sup>2</sup> AWG22 to 16

## ⑨ Power Supply Cable (M12 connector, For EX600-ED2) \* The shape of the M12 connector is B-coded (Reverse key).

- PCA-1564927 Straight 2 m
- PCA-1564930 Straight 6 m
- PCA-1564943 Right angled 2 m
- PCA-1564969 Right angled 6 m



**SPEEDCON**

### Straight connector type

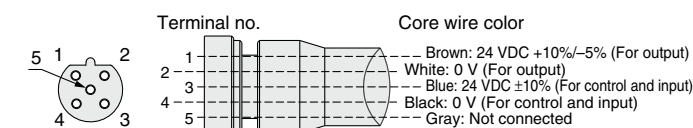
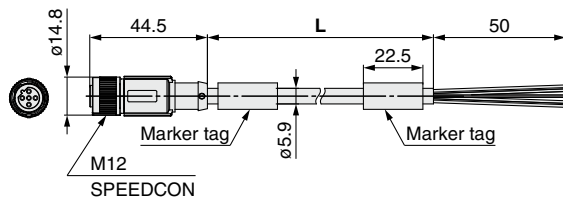

Socket connector pin arrangement B-coded (Reverse key)

### Angled connector type

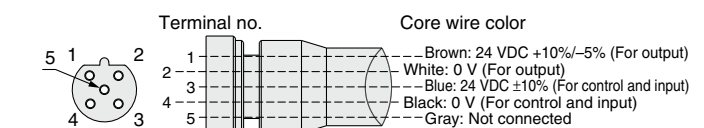
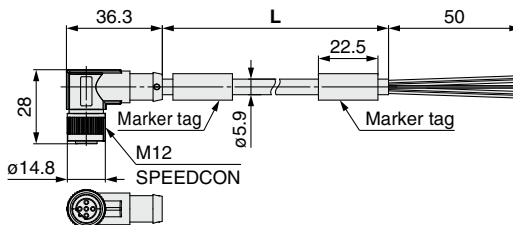

Socket connector pin arrangement B-coded (Reverse key)

Item	Specifications
Cable O.D.	5.9 mm
Conductor nominal cross section	0.34 mm <sup>2</sup> /AWG22
Wire O.D. (Including insulator)	1.27 mm
Min. bending radius (Fixed)	59 mm

**⑩ Power Supply Cable (M12 connector, For EX600-ED4/5)**

\* The shape of the M12 connector is A-coded (Normal key).

**EX500-AP 050 - S**

**Cable length (L)**

<b>010</b>	1000 mm
<b>050</b>	5000 mm

**Connector specification**

<b>S</b>	Straight
<b>A</b>	Angled



**Straight connector type**

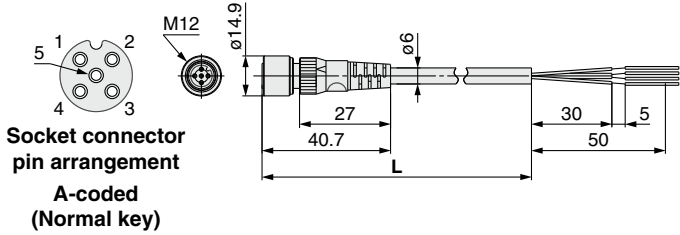

Item	Specifications
<b>Cable O.D.</b>	ø6 mm
<b>Nominal cross section</b>	0.3 mm <sup>2</sup> /AWG22
<b>Wire diameter (Including insulator)</b>	1.5 mm
<b>Min. bending radius</b>	40 mm (Fixed)

**Angled connector type**

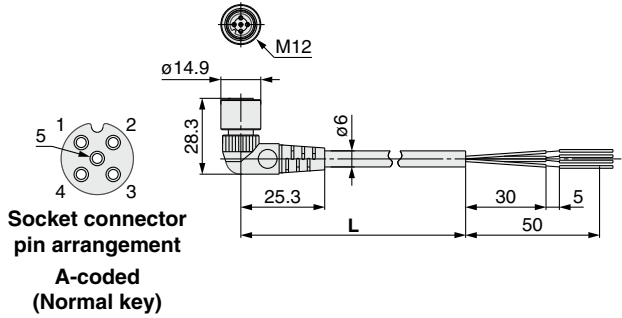

Item	Specifications
<b>Cable O.D.</b>	ø6 mm
<b>Nominal cross section</b>	0.3 mm <sup>2</sup> /AWG22
<b>Wire diameter (Including insulator)</b>	1.5 mm
<b>Min. bending radius</b>	40 mm (Fixed)

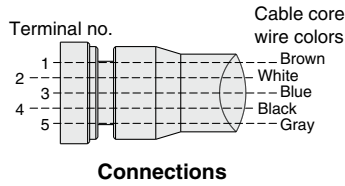

**SPEEDCON**

**PCA-1401804**

**Cable length (L)**

<b>1401804</b>	1500 mm
<b>1401805</b>	3000 mm
<b>1401806</b>	5000 mm

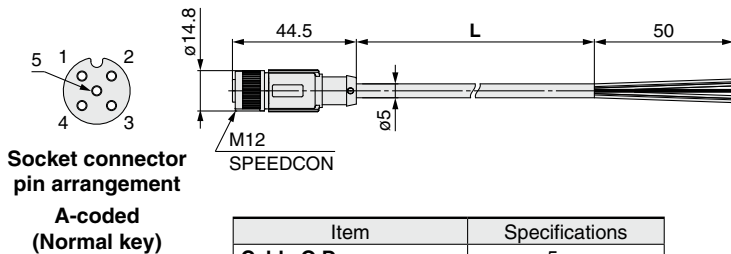

Item	Specifications
<b>Cable O.D.</b>	ø5 mm
<b>Nominal cross section</b>	0.3 mm <sup>2</sup> /AWG22
<b>Wire diameter (Including insulator)</b>	1.27 mm
<b>Min. bending radius</b>	21.7 mm (Fixed)

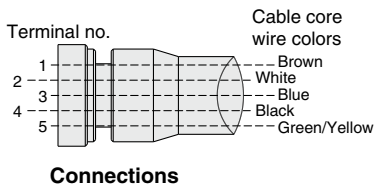

**PCA-1557769**

**Cable length (L)**

<b>1557769</b>	3000 mm
----------------	---------

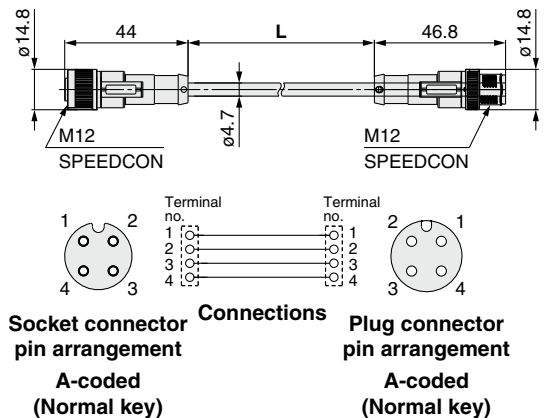

# EX600 Series

## ① Communication Cable

For CC-Link

**PCA-1567720**  
(Socket)

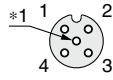

Socket connector pin arrangement  
A-coded (Normal key)  
\*1 Number of holes: 5,  
Total number of pins: 4

**PCA-1567717**  
(Plug)



Plug connector pin arrangement  
A-coded (Normal key)

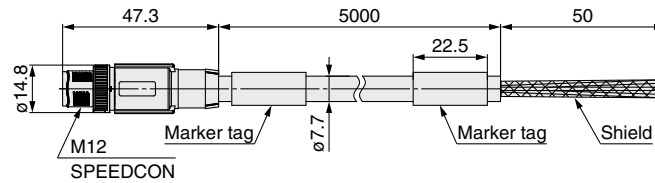
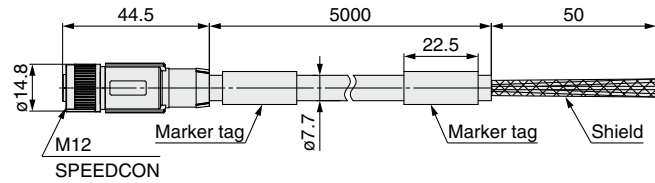

Made to Order

Cable length	10000 mm	p. 43
--------------	----------	-------

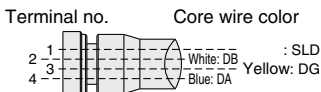

Connections

Item		Specifications
Cable O.D.		ø7.7 mm
Conductor nominal cross section	Data pair	0.5 mm <sup>2</sup> /AWG20
	Drain	0.34 mm <sup>2</sup> /AWG22
Wire O.D. (Including insulator)		2.55 mm
Min. bending radius (Fixed)		77 mm

**EX9-AC 005 MJ-SSPS** (With connector on both sides (Socket/Plug))

• Cable length (L)

005	500 mm
010	1000 mm
020	2000 mm
030	3000 mm
050	5000 mm
100	10000 mm

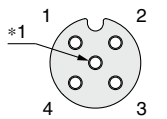
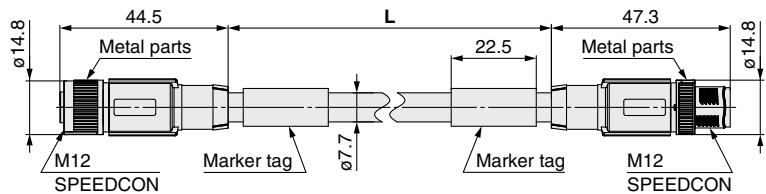

Socket connector pin arrangement  
A-coded (Normal key)

\*1 Number of holes: 5,  
Total number of pins: 4

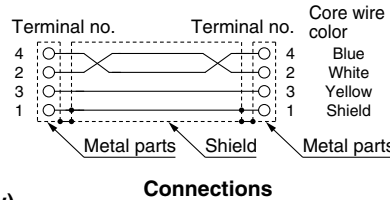

Connections

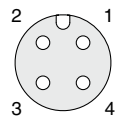

Plug connector pin arrangement  
A-coded (Normal key)

Item		Specifications
Cable O.D.		ø7.7 mm
Conductor nominal cross section	Data pair	0.5 mm <sup>2</sup> /AWG20
	Drain	0.34 mm <sup>2</sup> /AWG22
Wire O.D. (Including insulator)		2.55 mm
Min. bending radius (Fixed)		77 mm

**EX9-AC 005 MJ-SAPA** (With angled connector on both sides (Socket/Plug))

• Cable length (L)

005	500 mm
010	1000 mm
020	2000 mm
030	3000 mm
050	5000 mm
100	10000 mm

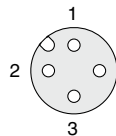
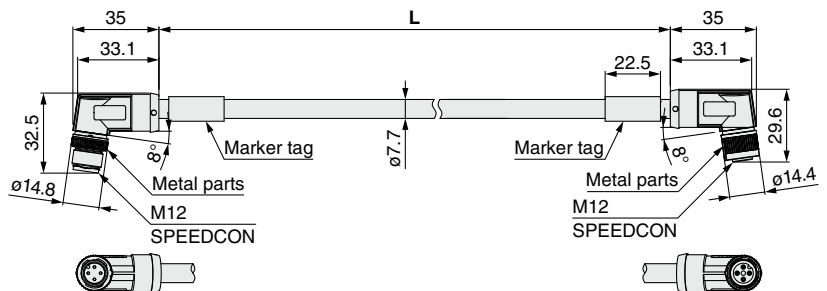

Plug connector pin arrangement  
A-coded (Normal key)

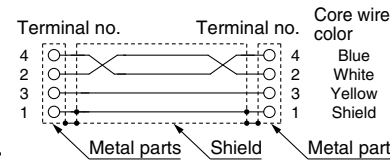

Connections

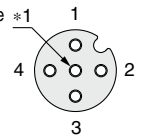

Socket connector pin arrangement  
A-coded (Normal key)

\*1 Number of holes: 5,  
Total number of pins: 4

Item		Specifications
Cable O.D.		ø7.7 mm
Conductor nominal cross section	Data pair	0.5 mm <sup>2</sup> /AWG20
	Drain	0.34 mm <sup>2</sup> /AWG22
Wire O.D. (Including insulator)		2.55 mm
Min. bending radius (Fixed)		77 mm

**① Communication Cable**

**For DeviceNet™**

**PCA-1557633**  
(Socket)

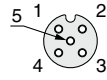

Socket connector pin arrangement A-coded (Normal key)

**PCA-1557646**  
(Plug)

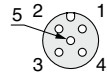

Plug connector pin arrangement A-coded (Normal key)

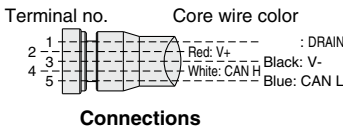
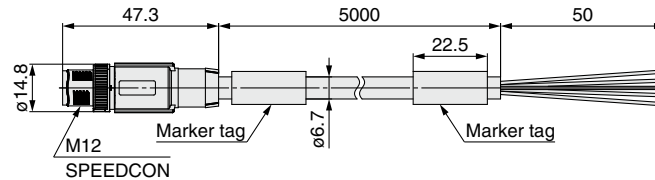
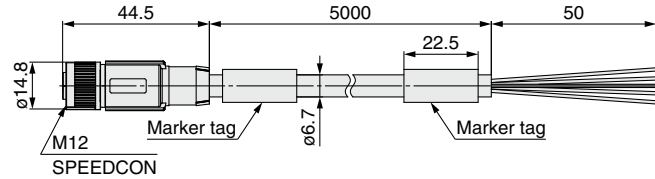

Item		Specifications
<b>Cable O.D.</b>		ø6.7 mm
<b>Conductor nominal cross section</b>	Power pair	0.34 mm <sup>2</sup> /AWG22
	Data pair	0.25 mm <sup>2</sup> /AWG24
<b>Wire O.D. (Including insulator)</b>	Power pair	1.4 mm
	Data pair	1.95 mm
<b>Min. bending radius (Fixed)</b>		67 mm



**Made to Order**

Cable length	10000 mm	p. 43
--------------	----------	-------

**EX9-AC 005 DN-SSPS (With connector on both sides (Socket/Plug))**

• Cable length (L)

<b>005</b>	500 mm
<b>010</b>	1000 mm
<b>020</b>	2000 mm
<b>030</b>	3000 mm
<b>050</b>	5000 mm
<b>100</b>	10000 mm

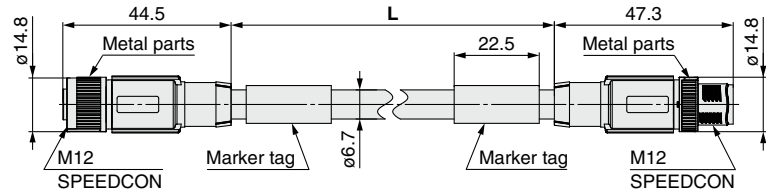

Item		Specifications
<b>Cable O.D.</b>		ø6.7 mm
<b>Conductor nominal cross section</b>	Power pair	0.34 mm <sup>2</sup> /AWG22
	Data pair	0.25 mm <sup>2</sup> /AWG24
<b>Wire O.D. (Including insulator)</b>	Power pair	1.4 mm
	Data pair	1.95 mm
<b>Min. bending radius (Fixed)</b>		67 mm

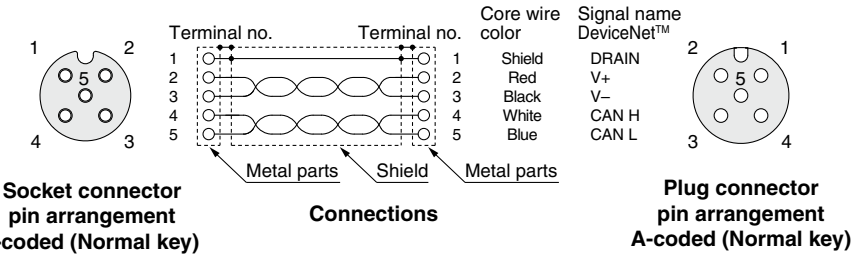

**EX9-AC 005 DN-SAPA (With angled connector on both sides (Socket/Plug))**

• Cable length (L)

<b>005</b>	500 mm
<b>010</b>	1000 mm
<b>020</b>	2000 mm
<b>030</b>	3000 mm
<b>050</b>	5000 mm
<b>100</b>	10000 mm

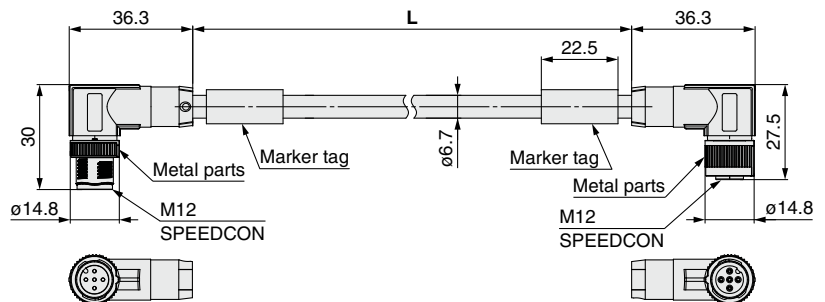

Item		Specifications
<b>Cable O.D.</b>		ø6.7 mm
<b>Conductor nominal cross section</b>	Power pair	0.34 mm <sup>2</sup> /AWG22
	Data pair	0.25 mm <sup>2</sup> /AWG24
<b>Wire O.D. (Including insulator)</b>	Power pair	1.4 mm
	Data pair	1.95 mm
<b>Min. bending radius (Fixed)</b>		67 mm

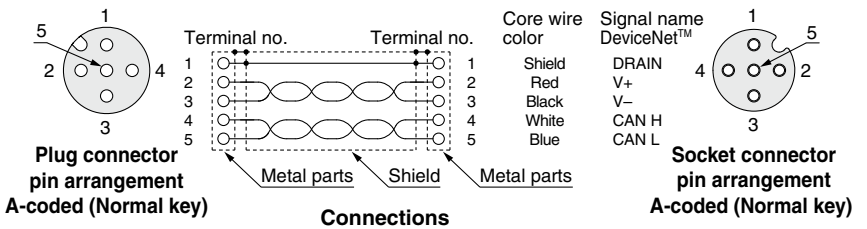

# EX600 Series

## ① Communication Cable

### For PROFIBUS DP

**PCA-1557688**  
(Socket)

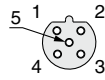

Socket connector pin arrangement B-coded (Reverse key)

**PCA-1557691**  
(Plug)

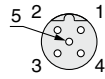

Plug connector pin arrangement B-coded (Reverse key)

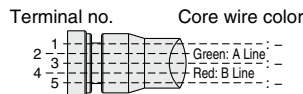
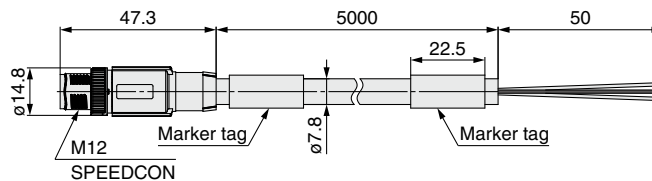
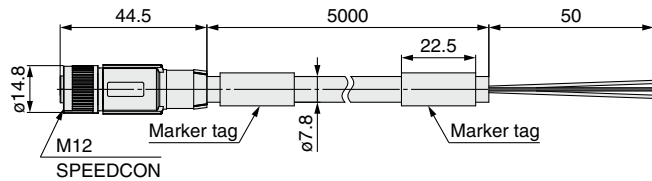

Shield line is connected to the knurl.  
**Connections**

Item	Specifications
<b>Cable O.D.</b>	ø7.8 mm
<b>Conductor nominal cross section</b>	0.34 mm <sup>2</sup> /AWG22
<b>Wire O.D. (Including insulator)</b>	2.55 mm
<b>Min. bending radius (Fixed)</b>	78 mm

### For EtherCAT® For PROFINET For EtherNet/IP™

**EX9-AC 020 EN-PSRJ** (Plug/RJ-45 connector)

● **Cable length (L)**

<b>010</b>	1000 mm
<b>020</b>	2000 mm
<b>030</b>	3000 mm
<b>050</b>	5000 mm
<b>100</b>	10000 mm

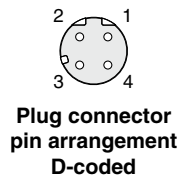
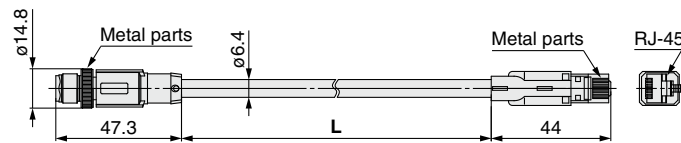

Plug connector pin arrangement D-coded

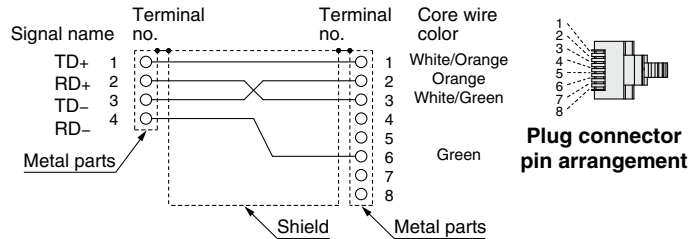

**Connections (Straight cable)**

Item	Specifications
<b>Cable O.D.</b>	ø6.4 mm
<b>Conductor nominal cross section</b>	0.14 mm <sup>2</sup> /AWG26
<b>Wire O.D. (Including insulator)</b>	0.98 mm
<b>Min. bending radius (Fixed)</b>	26 mm

**PCA-1446566** (Plug)

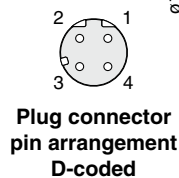

Plug connector pin arrangement D-coded

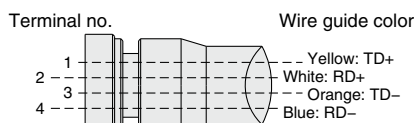
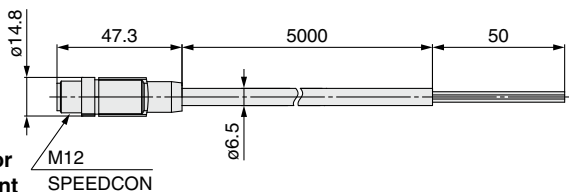

**Connections**

Item	Specifications
<b>Cable O.D.</b>	ø6.5 mm
<b>Conductor nominal cross section</b>	AWG22
<b>Wire O.D. (Including insulator)</b>	1.55 mm
<b>Min. bending radius (Fixed)</b>	45.5 mm

**① Communication Cable**

For EtherCAT® For PROFINET For EtherNet/IP™

**EX9-AC 005 EN-PSPS (With connector on both sides (Plug/Plug))**

• Cable length (L)

005	500 mm
010	1000 mm
020	2000 mm
030	3000 mm
050	5000 mm
100	10000 mm

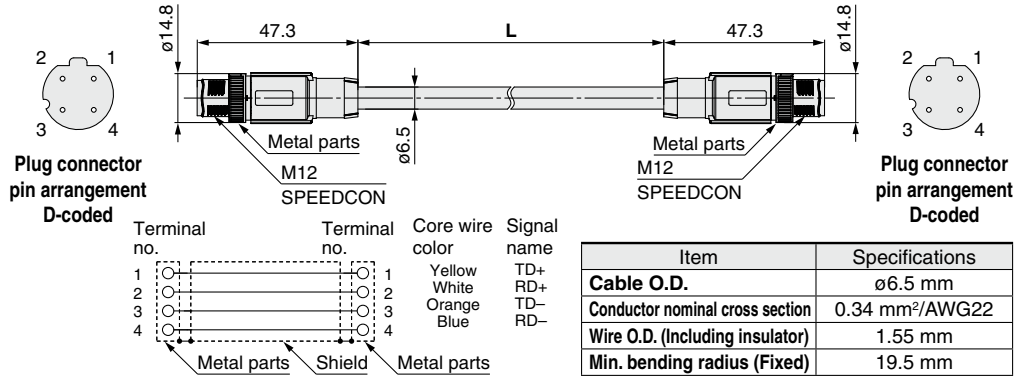

Connections (Straight cable)

**EX9-AC 005 EN-PAPA (With angled connector on both sides (Plug/Plug))**

• Cable length (L)

005	500 mm
010	1000 mm
020	2000 mm
030	3000 mm
050	5000 mm
100	10000 mm

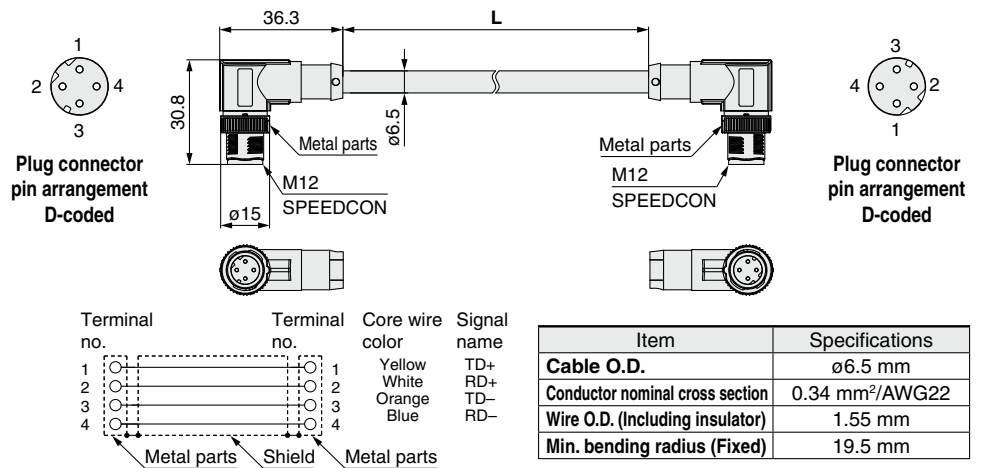

Connections (Straight cable)

# EX600 Series

## ① Communication Cable

### For IO-Link Master Unit

#### EX9-AC 005 -SSPS (With connector on both sides (Socket/Plug))

##### ● Cable length (L)

005	500 mm
010	1000 mm
020	2000 mm
030	3000 mm
050	5000 mm
100	10000 mm

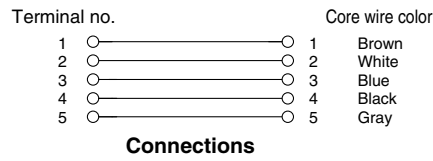
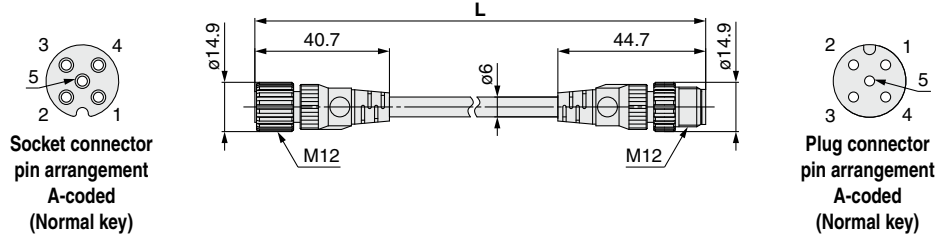

Item	Specifications
<b>Cable O.D.</b>	$\phi 6$ mm
<b>Conductor nominal cross section</b>	0.3 mm <sup>2</sup> /AWG22
<b>Wire O.D. (Including conductor)</b>	1.5 mm
<b>Min. bending radius (Fixed)</b>	40 mm



## ⑫ Field-wireable Communication Connector

### Plug

**For CC-Link**   **For DeviceNet™**  
**PCA-1075526**   **PCA-1075528**

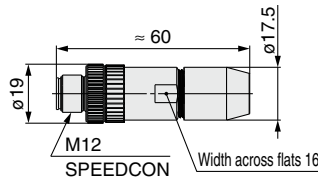

**For PROFIBUS DP**  
**PCA-1075530**

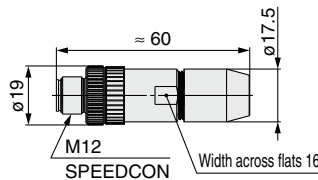

#### Applicable Cable

Item	Specifications
<b>Cable O.D.</b>	4.0 to 8.0 mm
<b>Wire gauge (Stranded wire cross section)</b>	0.14 to 0.75 mm <sup>2</sup> /AWG26 to 18 (Solid cable/Flexible cable) 0.08 to 0.5 mm <sup>2</sup> /AWG28 to 20 (With ferrule)

**For EtherCAT®**   **For PROFINET**   **For EtherNet/IP™**  
**PCA-1446553**

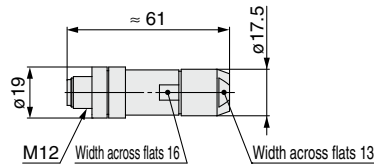
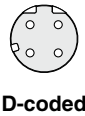

#### Applicable Cable

Item	Specifications
<b>Cable O.D.</b>	4.0 to 8.0 mm
<b>Wire gauge (Stranded wire cross section)</b>	0.14 to 0.34 mm <sup>2</sup> /AWG26 to 22

\* The table above shows the specifications for the applicable cable. Adaptation for the connector may vary on account of the conductor construction of the electric wire.

### Socket

**For CC-Link**   **For DeviceNet™**  
**PCA-1075527**   **PCA-1075529**

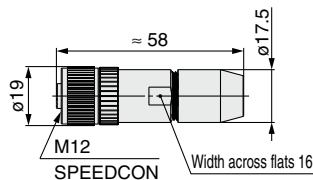

**For PROFIBUS DP**  
**PCA-1075531**

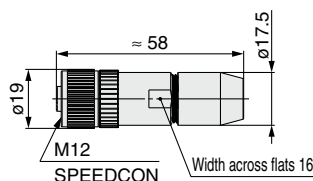



#### Applicable Cable

Item	Specifications
<b>Cable O.D.</b>	4.0 to 8.0 mm
<b>Wire gauge (Stranded wire cross section)</b>	0.14 to 0.75 mm <sup>2</sup> /AWG26 to 18 (Solid cable/Flexible cable) 0.08 to 0.5 mm <sup>2</sup> /AWG28 to 20 (With ferrule)

# EX600 Series

## ⑬ I/O Cable with Connector, I/O Connector

For details, refer to the **Web Catalog**.

Name	Use	Part no.	Description
<b>Cable with connector</b>		<b>PCA-1557769</b>	Cable with M12 connector (4 pins/3 m)
		<b>PCA-1557772</b>	Cable with M8 connector (3 pins/3 m)
<b>Field-wireable connector</b>		<b>PCA-1557730</b>	Field-wireable connector (M8/3 pins/Plug/Piercecon® connection)
		<b>PCA-1557743</b>	Field-wireable connector (M12/4 pins/Plug/QUICKON-ONE connection/SPEEDCON)
		<b>PCA-1557756</b>	Field-wireable connector (M12/4 pins/Plug/QUICKON-ONE connection/SPEEDCON)
<b>Y connector</b>		<b>PCA-1557785</b>	Y connector (2 x M12 (5 pins)-M12 (5 pins)/SPEEDCON)
		<b>PCA-1557798</b>	Y connector (2 x M8 (3 pins)-M12 (4 pins)/SPEEDCON)

\* When using the Y connector, connect it to the connector on the I/O unit through the sensor cable (PCA-1557769) with the M12 connector.

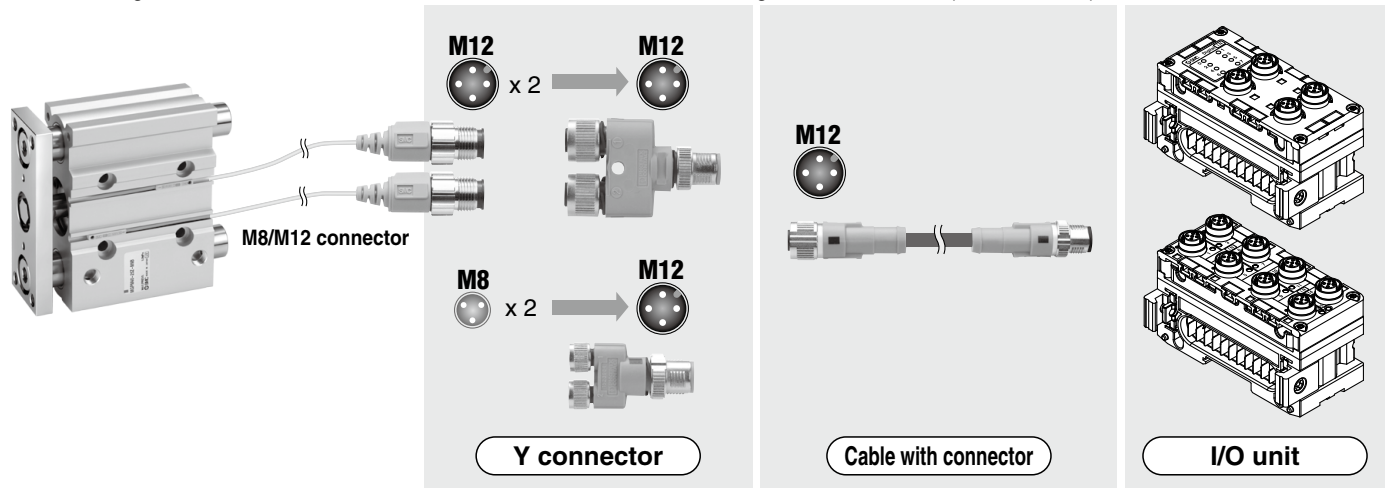

# EX600 Series Made to Order

Please contact SMC for detailed specifications and lead times.



## SI Unit

Prepare the SI unit, each type of unit, and the manifold valve (without SI unit) separately, and combine them before use.

### ① MRP (PROFINET) compatible

#### EX600-SPN1A-X34

- Dimensions are the same as those of the EX600-SPN1.

### ③ Modbus/TCP compatible

#### EX600-SMT1-X25

- Dimensions are the same as those of the EX600-SEN3.

### ⑤ EtherNet/IP™ IO-Link master unit compatible

#### EX600-SEN3-X80

- Dimensions are the same as those of the EX600-SEN3.

### ② Ethernet POWERLINK compatible

#### EX600-SPL1-X26

- Dimensions are the same as those of the EX600-SEN3.

### ④ CC-Link IE Field compatible

#### EX600-SCF 1-X60

#### • Output polarity

1	PNP
2	NPN

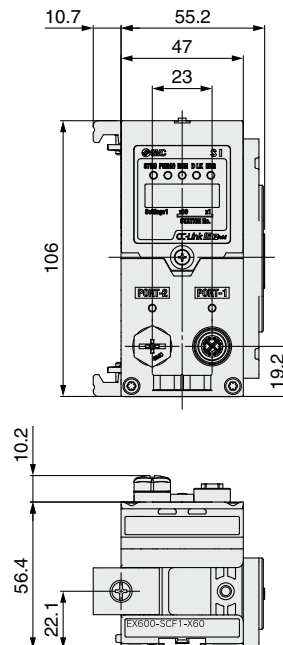

# EX600 Series

## Communication Cable

With connector on one side (Socket)

Cable length: 10000 mm

For CC-Link    For DeviceNet™

EX9-AC100 MJ -X12

• Applicable protocol

MJ	CC-Link
DN	DeviceNet™

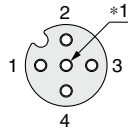

Socket connector pin arrangement A-coded (Normal key)

### For CC-Link

#### Dimensions

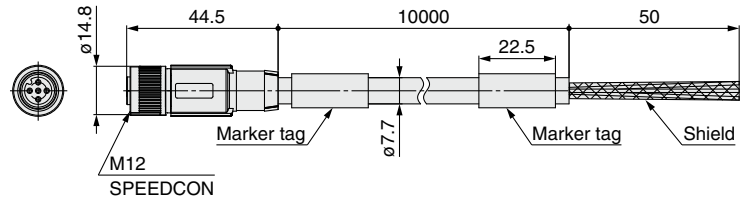

#### Connections

Terminal no.	Core wire color: Signal name (CC-Link)
1	Shield: SLD
2	White: DB
3	Yellow: DG
4	Blue: DA

\*1 Number of holes: 5, Total number of pins: 4

Item		Specifications
Cable O.D.		ø7.7 mm
Conductor nominal cross section	Data pair	0.5 mm <sup>2</sup> /AWG20
	Drain	0.34 mm <sup>2</sup> /AWG22
Wire O.D. (Including insulator)		2.55 mm
Min. bending radius (Fixed)		77 mm

### For DeviceNet™

#### Dimensions

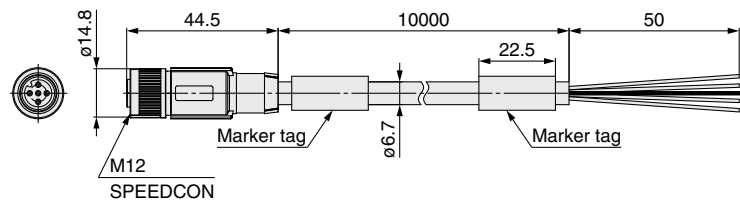

#### Connections

Terminal no.	Core wire color: Signal name (DeviceNet™)
1	Shield: DRAIN
2	Red: V+
3	Black: V-
4	White: CAN H
5	Blue: CAN L

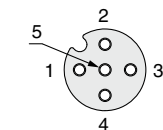

Socket connector pin arrangement A-coded (Normal key)

Item		Specifications
Cable O.D.		ø6.7 mm
Conductor nominal cross section	Power pair	0.34 mm <sup>2</sup> /AWG22
	Data pair	0.25 mm <sup>2</sup> /AWG24
Wire O.D. (Including insulator)	Power pair	1.4 mm
	Data pair	2.05 mm
Min. bending radius (Fixed)		67 mm



# EX600 Series

## Specific Product Precautions

Be sure to read this before handling the products. Refer to the back cover for safety instructions. For fieldbus system precautions, refer to the "Operation Manual" on the SMC website: <https://www.smcworld.com>

### Mounting

#### ⚠ Caution

1. When handling and assembling units, do not touch the sharp metal parts of the connector or plug.
2. When connecting six stations or more, be sure to use the intermediate reinforcing brace (EX600-ZMB1 or EX600-ZMB2).

### Operating Environment

#### ⚠ Caution

1. Select the proper type of enclosure according to the operating environment.

IP65/67 is achieved when the following conditions are met.

- 1) Provide appropriate wiring between all units using electrical wiring cables, communication connectors and cables with M12 connectors.
- 2) Appropriately mount each unit and valve manifold.
- 3) Be sure to mount a seal cap on any unused connectors.

If using in an environment that is exposed to water splashes, please take measures such as using a cover.

When the enclosure is IP40, do not use in an operating environment or atmosphere where it may come in contact with corrosive gas, chemical agents, seawater, water, or water vapor. When connected to the EX600-D□□E or EX600-D□□F, manifold enclosure is IP40.

Also, the handheld terminal conforms to IP20, so prevent foreign matter from entering inside, and water, solvent or oil from coming in direct contact with it.

### Adjustment / Operation

#### ⚠ Warning

<Handheld Terminal>

1. Do not apply pressure to the LCD.

There is a possibility of the crack of LCD and injuring.

2. The forced input/output function is used to change the signal status forcibly. When operating this function, be sure to check the safety of the surroundings and installation.

This may cause injuries or equipment damage.

3. Incorrect setting of parameters can cause a malfunction. Be sure to check the settings before use.

This may cause injuries or equipment damage.

#### ⚠ Caution

<Handheld Terminal>

1. Do not press the setting buttons with a sharp pointed object.

This may cause damage or equipment failure.

2. Do not apply excessive load and impact to the setting buttons.

This may cause damage, equipment failure or malfunction.

When the order does not include the SI unit, a valve plate which connects the manifold and SI unit, is not mounted. Use attached valve holding screws and mount the valve plate.

(Tightening torque: 0.6 to 0.7 N·m)

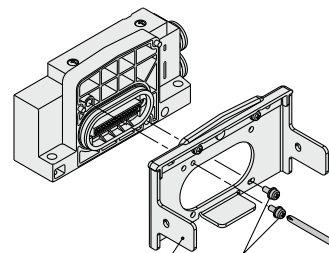

Valve plate Valve holding screw

- Screw tightened parts
- SV series: 2 places
  - S0700 series: 2 places
  - VQC1000 series: 2 places
  - VQC2000 series: 3 places
  - VQC4000 series: 4 places
  - VQC5000 series: 4 places
  - SY series: 2 places
  - JSY series: 2 places

#### ■ Trademark

DeviceNet™ is a trademark of ODVA.

EtherNet/IP™ is a trademark of ODVA.

EtherCAT® is registered trademark and patented technology, licensed by Beckhoff Automation GmbH, Germany.

Modbus® is a registered trademark of Schneider Electric, licensed to the Modbus Organization, Inc.

QuickConnect™ is a trademark of ODVA.

## Safety Instructions

These safety instructions are intended to prevent hazardous situations and/or equipment damage. These instructions indicate the level of potential hazard with the labels of “**Caution**,” “**Warning**” or “**Danger**.” They are all important notes for safety and must be followed in addition to International Standards (ISO/IEC)\*1), and other safety regulations.

**Caution:** **Caution** indicates a hazard with a low level of risk which, if not avoided, could result in minor or moderate injury.

**Warning:** **Warning** indicates a hazard with a medium level of risk which, if not avoided, could result in death or serious injury.

**Danger:** **Danger** indicates a hazard with a high level of risk which, if not avoided, will result in death or serious injury.

\*1) ISO 4414: Pneumatic fluid power – General rules relating to systems.  
 ISO 4413: Hydraulic fluid power – General rules relating to systems.  
 IEC 60204-1: Safety of machinery – Electrical equipment of machines.  
 (Part 1: General requirements)  
 ISO 10218-1: Manipulating industrial robots – Safety.  
 etc.

### Warning

#### 1. The compatibility of the product is the responsibility of the person who designs the equipment or decides its specifications.

Since the product specified here is used under various operating conditions, its compatibility with specific equipment must be decided by the person who designs the equipment or decides its specifications based on necessary analysis and test results. The expected performance and safety assurance of the equipment will be the responsibility of the person who has determined its compatibility with the product. This person should also continuously review all specifications of the product referring to its latest catalog information, with a view to giving due consideration to any possibility of equipment failure when configuring the equipment.

#### 2. Only personnel with appropriate training should operate machinery and equipment.

The product specified here may become unsafe if handled incorrectly. The assembly, operation and maintenance of machines or equipment including our products must be performed by an operator who is appropriately trained and experienced.

#### 3. Do not service or attempt to remove product and machinery/equipment until safety is confirmed.

1. The inspection and maintenance of machinery/equipment should only be performed after measures to prevent falling or runaway of the driven objects have been confirmed.
2. When the product is to be removed, confirm that the safety measures as mentioned above are implemented and the power from any appropriate source is cut, and read and understand the specific product precautions of all relevant products carefully.
3. Before machinery/equipment is restarted, take measures to prevent unexpected operation and malfunction.

#### 4. Contact SMC beforehand and take special consideration of safety measures if the product is to be used in any of the following conditions.

1. Conditions and environments outside of the given specifications, or use outdoors or in a place exposed to direct sunlight.
2. Installation on equipment in conjunction with atomic energy, railways, air navigation, space, shipping, vehicles, military, medical treatment, combustion and recreation, or equipment in contact with food and beverages, emergency stop circuits, clutch and brake circuits in press applications, safety equipment or other applications unsuitable for the standard specifications described in the product catalog.
3. An application which could have negative effects on people, property, or animals requiring special safety analysis.
4. Use in an interlock circuit, which requires the provision of double interlock for possible failure by using a mechanical protective function, and periodical checks to confirm proper operation.

### Caution

#### 1. The product is provided for use in manufacturing industries.

The product herein described is basically provided for peaceful use in manufacturing industries.  
 If considering using the product in other industries, consult SMC beforehand and exchange specifications or a contract if necessary.  
 If anything is unclear, contact your nearest sales branch.

### Limited warranty and Disclaimer/ Compliance Requirements

The product used is subject to the following “Limited warranty and Disclaimer” and “Compliance Requirements”.

Read and accept them before using the product.

#### Limited warranty and Disclaimer

1. The warranty period of the product is 1 year in service or 1.5 years after the product is delivered, whichever is first.\*2)  
 Also, the product may have specified durability, running distance or replacement parts. Please consult your nearest sales branch.
2. For any failure or damage reported within the warranty period which is clearly our responsibility, a replacement product or necessary parts will be provided.  
 This limited warranty applies only to our product independently, and not to any other damage incurred due to the failure of the product.
3. Prior to using SMC products, please read and understand the warranty terms and disclaimers noted in the specified catalog for the particular products.

#### \*2) Vacuum pads are excluded from this 1 year warranty.

A vacuum pad is a consumable part, so it is warranted for a year after it is delivered.  
 Also, even within the warranty period, the wear of a product due to the use of the vacuum pad or failure due to the deterioration of rubber material are not covered by the limited warranty.

#### Compliance Requirements

1. The use of SMC products with production equipment for the manufacture of weapons of mass destruction (WMD) or any other weapon is strictly prohibited.
2. The exports of SMC products or technology from one country to another are governed by the relevant security laws and regulations of the countries involved in the transaction. Prior to the shipment of a SMC product to another country, assure that all local rules governing that export are known and followed.

### Caution

#### SMC products are not intended for use as instruments for legal metrology.

Measurement instruments that SMC manufactures or sells have not been qualified by type approval tests relevant to the metrology (measurement) laws of each country. Therefore, SMC products cannot be used for business or certification ordained by the metrology (measurement) laws of each country.

#### Revision History

**Edition B** \* The EtherNet/IP™ communication protocol has been added.

\* An analog output unit and an input/output unit have been added.

\* A D-sub connector and a spring type terminal block have been added.

\* SY3000/5000 series valves have been added as applicable solenoid valves.

\* Number of pages has been decreased from 64 to 60. OW

**Edition C** \* The EtherCAT® communication protocol has been added. PX

**Edition D** \* The PROFINET communication protocol has been added. RS

**Edition E** \* A dual port EtherNet/IP™ product has been added.

\* SY7000 series valves have been added as applicable solenoid valves. TS

**Edition F** \* The IO-Link master unit has been added.

\* JSY series valves have been added as connectable valves.

\* The “How to Order” and “Dimensions” pages of the connectable valves have been deleted.

\* An end plate (D side) and M12 (4/5 pins) A-coded power supply connectors have been added.

\* Number of pages has been decreased from 68 to 48. YT

## Safety Instructions

Be sure to read the “Handling Precautions for SMC Products” (M-E03-3) and “Operation Manual” before use.