

Fieldbus System

(Output device for driving 5-port solenoid valves)



Space-saving installation

Compact
Approx.
28 mm

Actual size

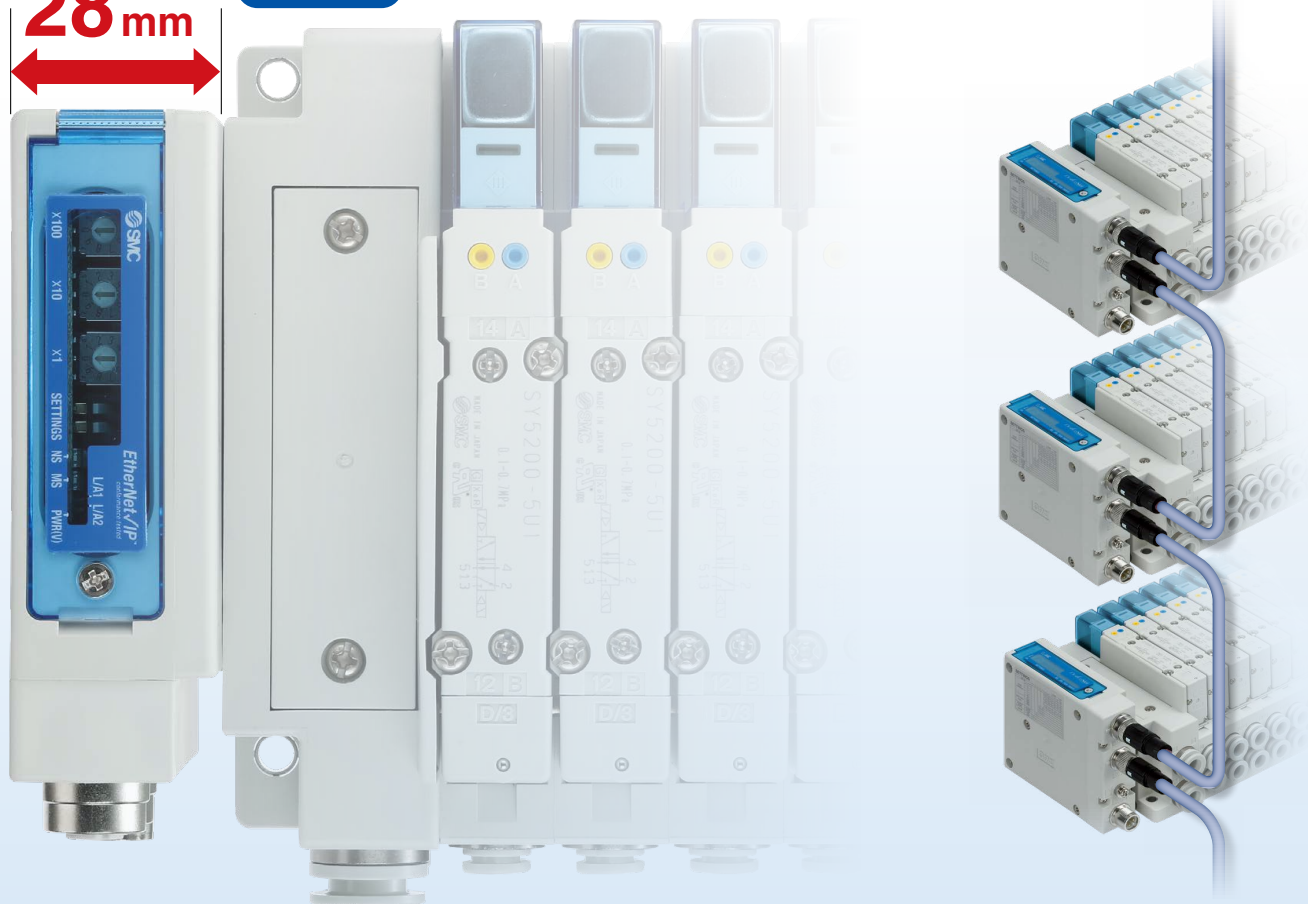

- **IP67**

* For units with a D-sub connector, and when connected to S0700 manifolds, it is IP40.

- **Drives up to 32 solenoids**

- **Daisy-chain wiring communication**

* Excludes the units compatible with IO-Link

<Compatible Protocols>



Made to Order



Please contact SMC for details on compatible products.

New



IO-Link compatible products have been added.

- Can be connected using a single cable
- Various types of diagnostic tests can be performed using service data.

Diagnostic contents	Internal failure of the SI unit	Output short circuit	Output open circuit
	Solenoid valve power supply failure	Abnormal internal temperature of the SI unit	Output switching count value exceeded



EX260 Series



CAT.E02-25C

Manifold length reduced by approx. 53 mm

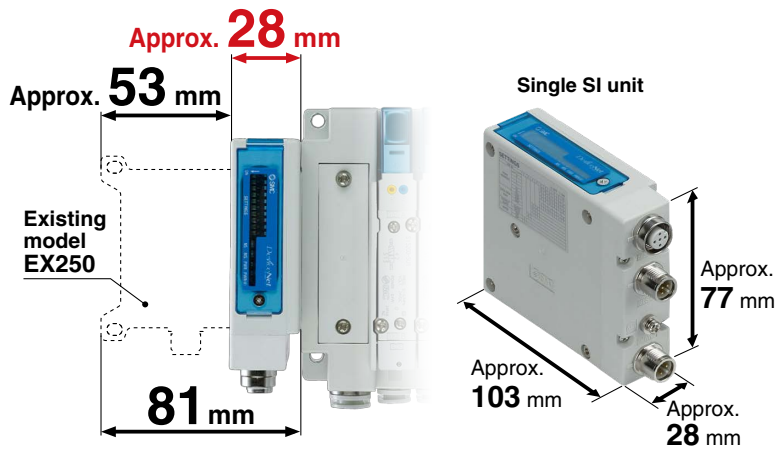

Wiring and piping from the same direction is possible. (for side ported)

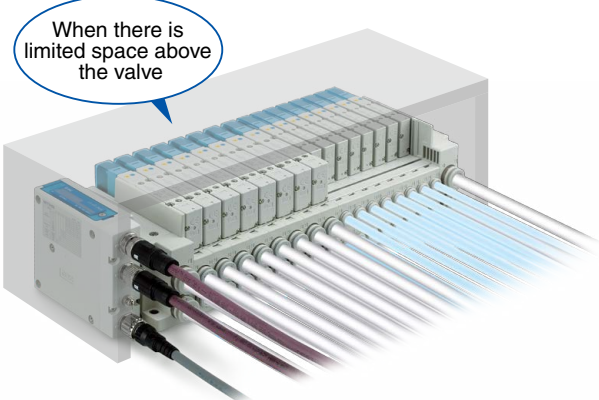

Daisy-chain wiring communication is possible.*1

A branch connector is not necessary/Reduced wiring space

*1 Excludes the units compatible with IO-Link

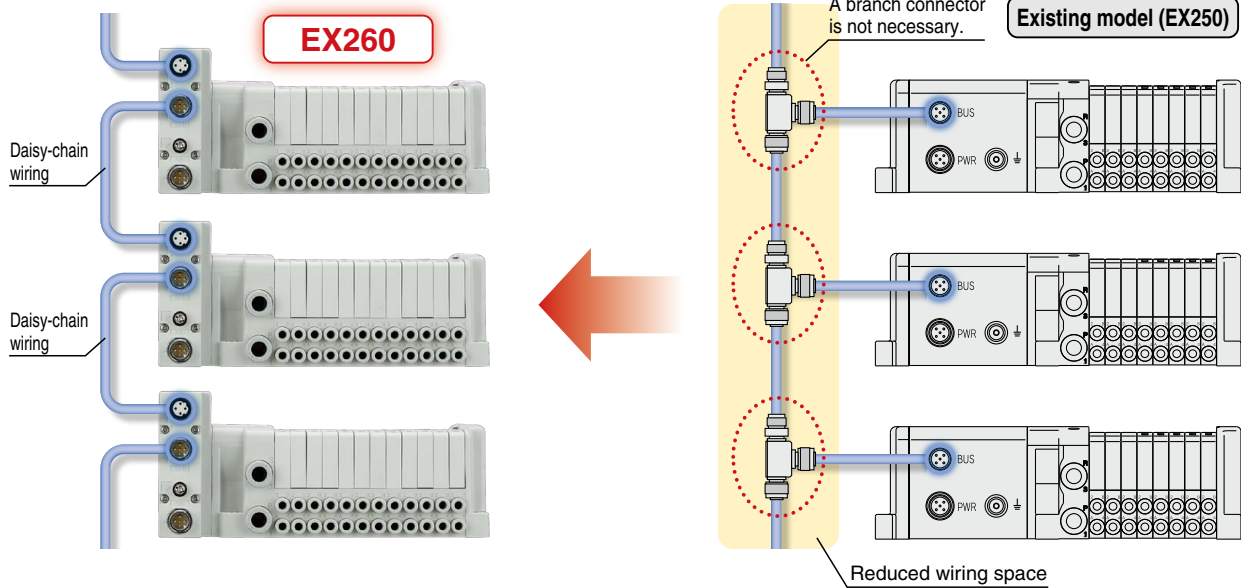

An external terminating resistor is not necessary.

(Only available for M12 PROFIBUS DP, CC-Link communication connectors)

ON/OFF switching is possible with an internal terminating resistor.
An external terminating resistor is not necessary.

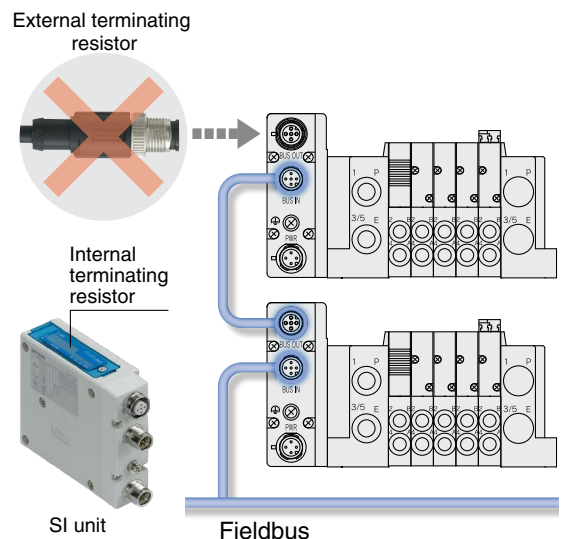

Product Specification Variations

			DeviceNet	CC-Link		EtherNet/IP	EtherCAT	ETHERNET POWERLINK	IO-Link
Number of outputs	16	●	●	●	●	●	●	●	
	32	●	●	●	●	●	●	●	●
Output polarity	PNP	●	●	●	●	●	●	●	●
	NPN	●	●	●	●	●	●	●	●
Communication connector	M12	●	●	●	●	●	●	●	●
	D-sub	●							

Applicable manifold	JSY Series	SY Series	SV Series	VQC Series	S0700 Series	SY Series	JSY Series	VQC Series

Communication connector examples



M12 communication connector x 2
(For daisy-chain wiring)



M12 communication connector x 1
(Same for the solenoid valve power supply wiring)



D-sub communication connector



Applicable Valve Series

Series	Flow rate characteristics (4/2 → 5/3)		Maximum number of solenoids	Power consumption [W]	Applicable cylinder size	
	C [dm ³ /(s·bar)]	b				
 IP67 *1	SY3000	1.6	0.19	0.35 (Standard) 0.1 (With power-saving circuit)	ø50	
	SY5000	3.6	0.17		32	ø63
	SY7000	5.9	0.20			ø80
 IP67 *1, *3	JSY1000	0.91	0.48	0.2 (With power-saving circuit) 0.4 (Standard) 0.1 (With power-saving circuit)	ø40	
	JSY3000	2.77	0.27		32	ø50
	JSY5000	6.59	0.22			ø80
 IP40	S0700 *2	0.37	0.39	0.35	ø25	
 IP67 *1	SV1000 *2	1.1	0.35	0.6	ø40	
	SV2000 *2	2.4	0.18		32	ø63
	SV3000 *2	4.3	0.21			ø80
 IP67 *1	VQC1000	1.0	0.30	0.4 (Standard) 0.95 (Standard) 0.4 (Low-wattage type)	ø40	
	VQC2000	3.2	0.30		24	ø63
	VQC4000	7.3	0.38			ø160
	VQC5000	17	0.31		ø180	

*1 Units with a D-sub communication connector are IP40.

*2 There is no manifold part number setting for the IO-Link compatible units.

*3 IP40 for the JSY1000

New IO-Link compatible

Integratable with various existing networks

IO-Link devices can be easily connected to various networks via the IO-Link master, which acts as a gateway between IO-Link communication and various Fieldbuses. Solenoid valves can be connected for communication without relying upon a Fieldbus or PLC.

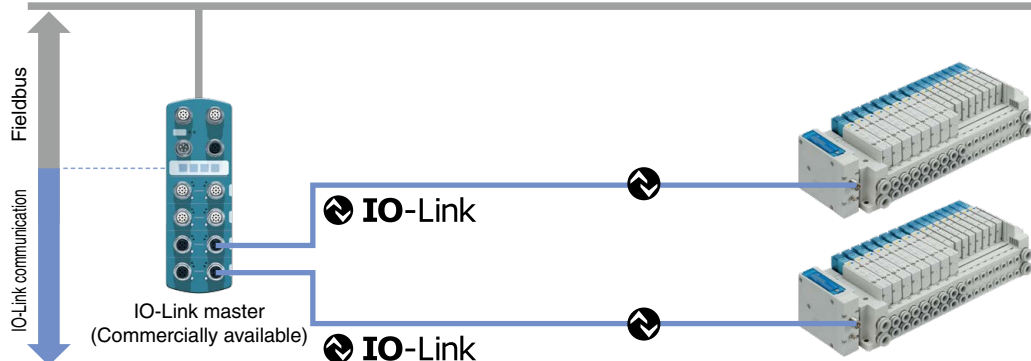

Can be connected using a single general-purpose cable, resulting in a reduction in the space required for wiring



Port class B compliant

Port class B

IO-Link master (Commercially available)

- Connect the IO-Link master port to the device using a 1:1 configuration.
- Connect using an M12 round connector.
- Maximum cable length: 20 m
- Special communication cables are not necessary.
- In order to connect the SI unit using a single cable, use a port class B type IO-Link master.

Power supply load



IO-Link

General-purpose 5-wire unshielded cables are used for connection. The signal wire and valve power supply wire can be connected with the same cable.

Port class A

IO-Link master (Commercially available)

Power supply load



IO-Link

SI unit/Connector pin arrangement

Pin no.	SI unit port pin function (Port class B)
1	+24 V for control unit
2	+24 V for solenoid valve
3	0 V for control unit
4	IO-Link communication
5	0 V for solenoid valve

Y Branch Connector

Port class A compliant
A special wiring Y branch connector is available.



Used when connecting to a port class A type IO-Link master, which is often used when connecting to an IO-Link sensor

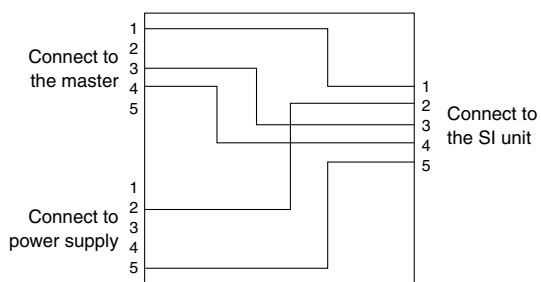

Difference between IO-Link master port class A and class B

Pin no.	IO-Link master port pin function	
	Port class A	Port class B
1	+24 V	+24 V
2	NC/DI/DO	Additional power supply +24 V
3	0 V	0 V
4	IO-Link/DI/DO	IO-Link/DI/DO
5	NC	Additional power supply 0 V

New IO-Link compatible

Features an impressive self-diagnosis function

Self-diagnosis contents

Diagnostic contents	Event category
Internal failure of the SI unit	Error
Output short circuit	Error
Output open circuit	Error
Solenoid valve power supply failure	Warning
Abnormal internal temperature of the SI unit	Warning
Output switching count value exceeded	Notification

Real-time diagnosis (Process data)

- Any event information detected by the SI unit using the process data as the diagnostic input can be transmitted to the PLC and PC in real time via the master Fieldbus.
- 3 types of event flags are transmitted to the PLC. (Error/Warning/Notification)

Request base diagnosis (Service data)

- Regarding detailed diagnostic information, the event codes can be transmitted as service data to the PLC and PC.

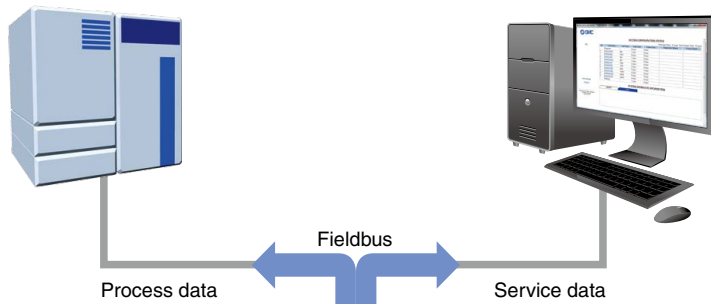

IO-Link master
(Commercially available)

IO-Link

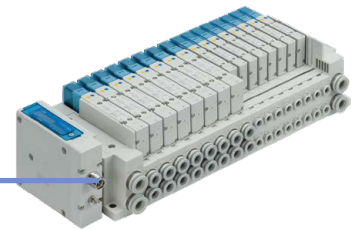

Equipped with a solenoid valve output operation count function

The number of valve operation instructions is counted for each output of the solenoid valve.

Set the count threshold value to be used as a guide for maintenance according to the operating conditions of the cylinder connected to the solenoid valve.



Once the threshold value is reached, notification of this fact will take place automatically.



This enables periodic maintenance to be performed before any unexpected cylinder failures occur.

IO-Link master
(Commercially available)



Notification of the fact that the count threshold has been exceeded

IO-Link

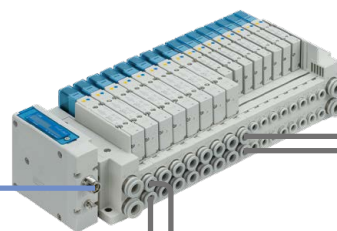

Currently at 10 million operations



Currently at 5 million operations



CONTENTS

Fieldbus System (Output device for driving 5-port solenoid valves) **EX260 Series**

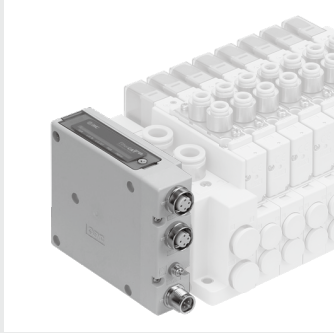

How to Order SI Units	p. 6
Specifications	p. 7
Dimensions	p. 8
Parts Description	p. 9
LED Indicator	p. 10

Accessories

① Communication Cable	p. 11
② Field-wireable Communication Connector	p. 17
③ Power Supply Cable (For SI unit)	p. 18
④ Power Supply Cable (For SI unit/For power block) ...	p. 19
⑤ Seal Cap (10 pcs.)	p. 19
⑥ Output Block	p. 20
⑦ Power Block	p. 20
⑧ Connector for Output Block Wiring	p. 21
⑨ End Plate	p. 21
⑩ Bracket Plate/DIN Rail Mounting Bracket	p. 21

Made to Order

SI Unit	
EtherNet/IP™ Web server function compatible	p. 22
Communication Cable	p. 22
Power Supply Cable	p. 23

Specific Product Precautions	p. 24
------------------------------------	-------

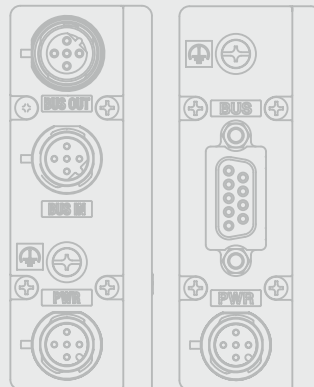
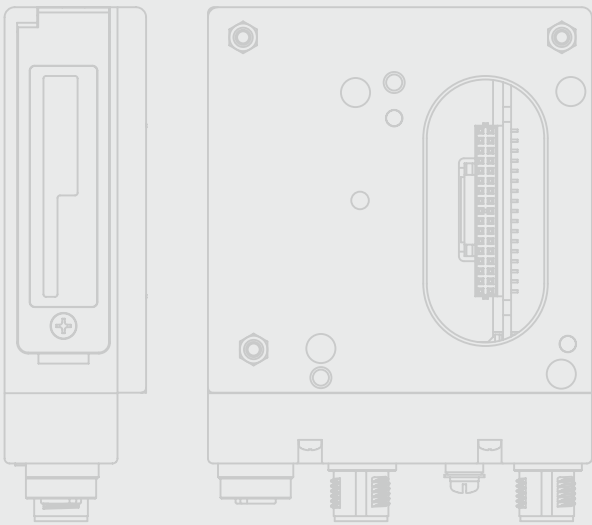

Fieldbus System For Output

EX260 Series



Compact design	Compact design for space saving
Number of outputs	32/16 digital output type available for each unit in the series (IO-Link is only compatible with the 32-point digital output type.)
Output polarity	Negative common (PNP)/positive common (NPN) type available for each unit in the series (Only negative common (PNP) is available for units compatible with Ethernet POWERLINK and IO-Link.)
Enclosure	IP67 (For units with a D-sub connector, and when connected with S0700 manifolds, it is IP40.)
Internal terminating resistor	ON/OFF switching is possible with an internal terminating resistor for communication. (Only for units compatible with M12 PROFIBUS DP, CC-Link communication connectors)

Applicable Manifold

SY3000/5000/7000

JSY1000/3000/5000

VQC1000/2000/4000/5000

S0700

SV1000/2000/3000

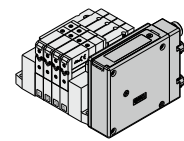
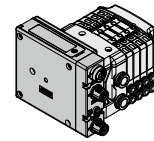
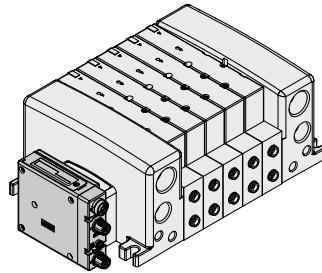
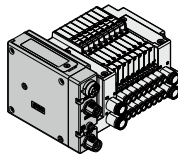
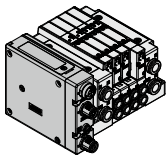

How to Order SI Units

EX260 - S PR1

Communication protocol

Symbol	Protocol	Number of outputs	Output polarity	Communication connector	Manifold symbol	Applicable manifold
DN1	DeviceNet™	32	Source/PNP (Negative common)	M12	QAN	SY3000 SY5000 SY7000 JSY1000 JSY3000 JSY5000 VQC1000 VQC2000 VQC4000 VQC5000 S0700 SV1000 SV2000 SV3000
DN2			Sink/NPN (Positive common)		QA	
DN3		16	Source/PNP (Negative common)		QBN	
DN4			Sink/NPN (Positive common)		QB	
PR1	PROFIBUS DP	32	Source/PNP (Negative common)	M12	NAN	
PR2			Sink/NPN (Positive common)		NA	
PR3		16	Source/PNP (Negative common)		NBN	
PR4			Sink/NPN (Positive common)		NB	
PR5		32	Source/PNP (Negative common)		D-sub*1	NCN
PR6			Sink/NPN (Positive common)			NC
PR7		16	Source/PNP (Negative common)			NDN
PR8			Sink/NPN (Positive common)			ND
MJ1	CC-Link	32	Source/PNP (Negative common)	M12		VAN
MJ2			Sink/NPN (Positive common)			VA
MJ3		16	Source/PNP (Negative common)			VBN
MJ4			Sink/NPN (Positive common)			VB

Symbol	Protocol	Number of outputs	Output polarity	Communication connector	Manifold symbol	Applicable manifold
EC1	EtherCAT	32	Source/PNP (Negative common)	M12	DAN	SY3000 SY5000 SY7000 JSY1000 JSY3000 JSY5000 VQC1000 VQC2000 VQC4000 VQC5000 S0700 SV1000 SV2000 SV3000
EC2			Sink/NPN (Positive common)		DA	
EC3		16	Source/PNP (Negative common)		DBN	
EC4			Sink/NPN (Positive common)		DB	
PN1	PROFINET	32	Source/PNP (Negative common)	M12	FAN	
PN2			Sink/NPN (Positive common)		FA	
PN3		16	Source/PNP (Negative common)		FBN	
PN4			Sink/NPN (Positive common)		FB	
EN1	EtherNet/IP™	32	Source/PNP (Negative common)	M12	EAN	
EN2			Sink/NPN (Positive common)		EA	
EN3		16	Source/PNP (Negative common)		EBN	
EN4			Sink/NPN (Positive common)		EB	
PL1	Ethernet POWERLINK	32	Source/PNP (Negative common)	M12	GAN	
PL3		16			GBN	
IL1	IO-Link	32	Source/PNP (Negative common)	M12	KAN	SY3000/5000/7000 JSY1000/3000/5000 VQC1000/2000/4000/5000

*1 Enclosure is IP40 when the communication connector is D-sub.



Made to Order

→ p. 22

EtherNet/IP™ Web server function compatible

* For "How to Order Manifold Assembly," refer to the **Web Catalog** of each valve.



EX260 Series

Specifications

All SI Units Common Specifications

Power supply for control	Power supply voltage	21.6 to 26.4 VDC*1
	Internal current consumption	100 mA or less
Power supply for output	Power supply voltage	22.8 to 26.4 VDC
Environmental resistance	Enclosure	IP67*2
	Operating temperature range	-10 to +50°C
	Operating humidity range	35 to 85%RH (No condensation)
	Withstand voltage	500 VAC for 1 minute between terminals and housing
	Insulation resistance	10 MΩ or more (500 VDC measured via megohmmeter) between terminals and housing
Standards	CE marking (EMC directive/RoHS directive), UL (CSA) compliant	
Weight	200 g	
Accessories	Mounting screw	2 pcs.
	Seal cap (for M12 connector socket)	EX9-AWTS (1 pc.)*3

*1 To serve as the power supply for communication, the power supply voltages are 11 to 25 VDC for the EX260-SDN□ and 18 to 30 VDC for the EX260-SIL1.

*2 IP40 applies to EX260-SPR5/6/7/8.

*3 Not provided for EX260-SPR5/6/7/8

Model	EX260-SPR1/3	EX260-SPR2/4	EX260-SPR5/7	EX260-SPR6/8	EX260-SDN1/3	EX260-SDN2/4	EX260-SMJ1/3	EX260-SMJ2/4	
Applicable system	Protocol	PROFIBUS DP				DeviceNet™		CC-Link	
	Version*1	DP-V0				Volume1 (Edition 3.5) Volume3 (Edition 1.5)		Ver. 1.10	
	Configuration file*3	GSD file				EDS file		CSP+ file	
I/O occupation area (Inputs/Outputs)	SPR1: 0/32 SPR3: 0/16	SPR2: 0/32 SPR4: 0/16	SPR5: 0/32 SPR7: 0/16	SPR6: 0/32 SPR8: 0/16	SDN1: 0/32 SDN3: 0/16	SDN2: 0/32 SDN4: 0/16	SMJ1: 32/32 SMJ3: 32/32 (1 station, remote I/O stations)	SMJ2: 32/32 SMJ4: 32/32 (1 station, remote I/O stations)	
Applicable function	—				QuickConnect™		—		
Communication speed	9.6 k/19.2 k/45.45 k/93.75 k/ 187.5 k/500 k/1.5 M/3 M/6 M/12 Mbps				125 k/250 k/500 kbps		156 k/625 k/ 2.5 M/5 M/10 Mbps		
Communication connector specification	M12			D-sub			M12		
Terminating resistor switch	Built-in			None			Built-in		
Output	Output type	Source/PNP (Negative common)	Sink/NPN (Positive common)	Source/PNP (Negative common)	Sink/NPN (Positive common)	Source/PNP (Negative common)	Sink/NPN (Positive common)	Source/PNP (Negative common)	Sink/NPN (Positive common)
	Number of outputs	SPR1: 32 points SPR3: 16 points	SPR2: 32 points SPR4: 16 points	SPR5: 32 points SPR7: 16 points	SPR6: 32 points SPR8: 16 points	SDN1: 32 points SDN3: 16 points	SDN2: 32 points SDN4: 16 points	SMJ1: 32 points SMJ3: 16 points	SMJ2: 32 points SMJ4: 16 points
	Load	Solenoid valve with surge voltage suppressor 24 VDC, 1.5 W or less (SMC)							
	Supplied voltage	24 VDC							
	Supplied current	SPR1: Max. 2.0 A SPR3: Max. 1.0 A	SPR2: Max. 2.0 A SPR4: Max. 1.0 A	SPR5: Max. 2.0 A SPR7: Max. 1.0 A	SPR6: Max. 2.0 A SPR8: Max. 1.0 A	SDN1: Max. 2.0 A SDN3: Max. 1.0 A	SDN2: Max. 2.0 A SDN4: Max. 1.0 A	SMJ1: Max. 2.0 A SMJ3: Max. 1.0 A	SMJ2: Max. 2.0 A SMJ4: Max. 1.0 A

Model	EX260-SEC1/3	EX260-SEC2/4	EX260-SPN1/3	EX260-SPN2/4	EX260-SEN1/3	EX260-SEN2/4	EX260-SPL1	EX260-SPL3	EX260-SIL1	
Applicable system	Protocol	EtherCAT*2		PROFINET*2		EtherNet/IP™*2		Ethernet POWERLINK*2		IO-Link
	Version*1	Conformance Test Record V.1.1		PROFINET Specification Version 2.2		Volume1 (Edition 3.17) Volume2 (Edition 1.18)		EPG DS 301 Version 1.2.0		V1.1
	Configuration file*3	XML file		GSD file		EDS file		XDD file		IODD file
I/O occupation area (Inputs/Outputs)	SEC1: 0/32 SEC3: 0/16	SEC2: 0/32 SEC4: 0/16	SPN1: 0/32 SPN3: 0/16	SPN2: 0/32 SPN4: 0/16	SEN1: 16/32 SEN3: 16/16	SEN2: 16/32 SEN4: 16/16	16/32	16/16	0/32 16/32*4	
Applicable function	—		FSU, MRP		QuickConnect™, DLR		—		—	
Communication speed	100 Mbps*2				10 M/100 Mbps*2		100 Mbps*2		COM3/COM2*4	
Communication connector specification	M12									
Terminating resistor switch	None (Not required)									
Output	Output type	Source/PNP (Negative common)	Sink/NPN (Positive common)	Source/PNP (Negative common)	Sink/NPN (Positive common)	Source/PNP (Negative common)	Sink/NPN (Positive common)	Source/PNP (Negative common)		
	Number of outputs	SEC1: 32 points SEC3: 16 points	SEC2: 32 points SEC4: 16 points	SPN1: 32 points SPN3: 16 points	SPN2: 32 points SPN4: 16 points	SEN1: 32 points SEN3: 16 points	SEN2: 32 points SEN4: 16 points	32	16	32
	Load	Solenoid valve with surge voltage suppressor 24 VDC, 1.5 W or less (SMC)		Solenoid valve with surge voltage suppressor 24 VDC, 1.0 W or less (SMC)		Solenoid valve with surge voltage suppressor 24 VDC, 1.5 W or less (SMC)				
	Supplied voltage	24 VDC								
	Supplied current	SEC1: Max. 2.0 A SEC3: Max. 1.0 A	SEC2: Max. 2.0 A SEC4: Max. 1.0 A	SPN1: Max. 2.0 A SPN3: Max. 1.0 A	SPN2: Max. 2.0 A SPN4: Max. 1.0 A	SEN1: Max. 2.0 A SEN3: Max. 1.0 A	SEN2: Max. 2.0 A SEN4: Max. 1.0 A	Max. 2 A	Max. 1 A	Max. 2 A

*1 Please note that the version is subject to change.

*2 Use a CAT5 or higher transmission cable for EtherCAT, PROFINET, EtherNet/IP™, and Ethernet POWERLINK.

*3 The configuration file can be downloaded from the SMC website, <https://www.smcworld.com>

*4 A selection can be made using the setting switch.

Dimensions

M12 communication connector type

- For PROFIBUS DP For DeviceNet™
- For CC-Link For EtherCAT For PROFINET
- For EtherNet/IP™ For Ethernet POWERLINK

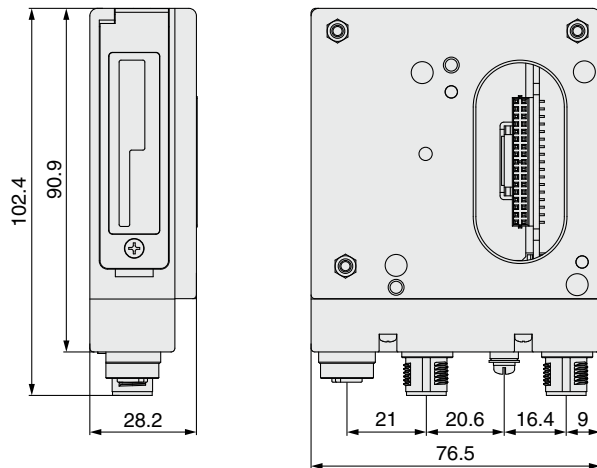

D-sub communication connector type (EX260-SPR5/6/7/8)

- For PROFIBUS DP

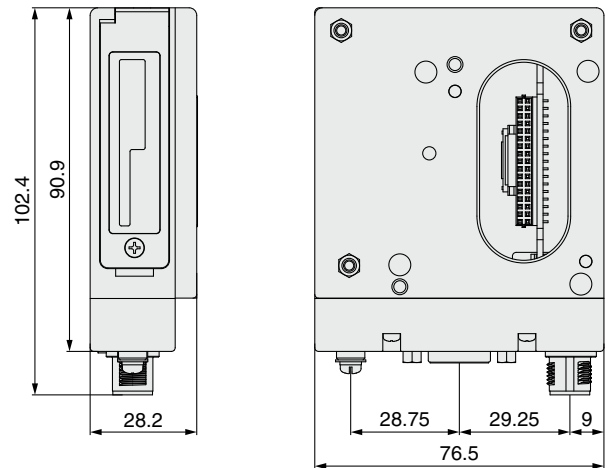

M12 communication connector type

- For IO-Link

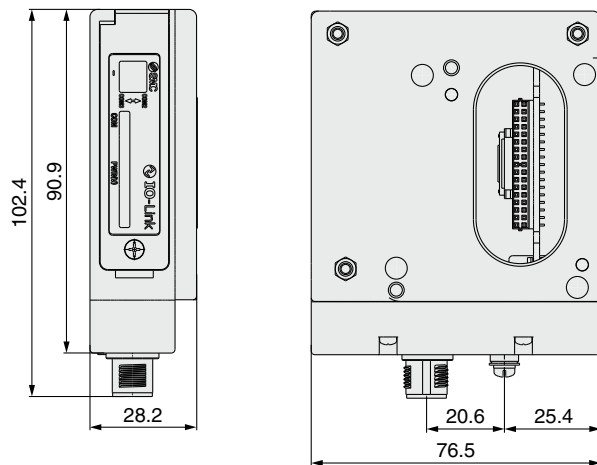

EX260 Series

Parts Description

For PROFIBUS DP For DeviceNet™ For CC-Link

For EtherCAT For PROFINET For EtherNet/IP™ For Ethernet POWERLINK

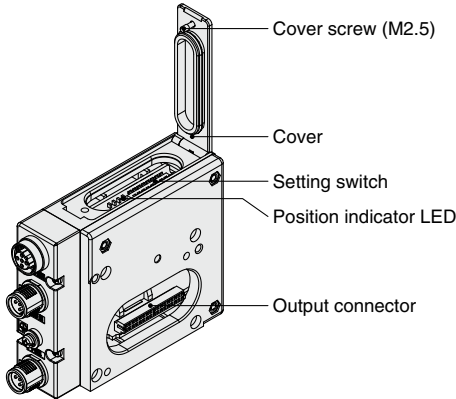

* The setting switch varies depending on the model. Refer to the operation manual for details. It can be downloaded via the SMC website: <https://www.smcworld.com>

<Connector>

M12 communication connector type

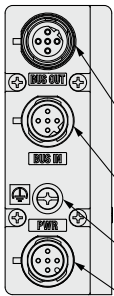

Part no.	EX260-SPR1/-SPR2 -SPR3/-SPR4	EX260-SDN□	EX260-SMJ□	EX260-SEC□ EX260-SPN□ EX260-SEN□ EX260-SPL□
Communication protocol	PROFIBUS DP	DeviceNet™	CC-Link	EtherCAT PROFINET EtherNet/IP™ Ethernet POWERLINK
Communication connector (M12) BUS OUT	5 pins, socket, B code (SPEEDCON)	5 pins, socket, A code (SPEEDCON)	5 pins, socket, A code* ¹ (SPEEDCON)	4 pins, socket, D code (SPEEDCON)
Communication connector (M12) BUS IN	5 pins, plug, B code (SPEEDCON)	5 pins, plug, A code (SPEEDCON)	4 pins, plug, A code (SPEEDCON)	4 pins, socket, D code (SPEEDCON)
Ground terminal	M3			
Power connector (M12)	5 pins, plug, A code (SPEEDCON)	4 pins, plug, A code (SPEEDCON)	5 pins, plug, B code (SPEEDCON)	5 pins* ² , 4 pins* ³ , plug, A code (SPEEDCON)

*¹ Recommended mating M12 4-pin plug part no.: PCA-1567717
*² For EtherCAT, PROFINET, and Ethernet POWERLINK
*³ For EtherNet/IP™

D-sub communication connector type

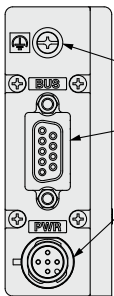

Part no.	EX260-SPR5/-SPR6/-SPR7/-SPR8
Communication protocol	PROFIBUS DP
Ground terminal	M3
Communication connector (D-sub) BUS IN/OUT	9 pins, socket
Power connector (M12)	5 pins, plug, A code

For IO-Link

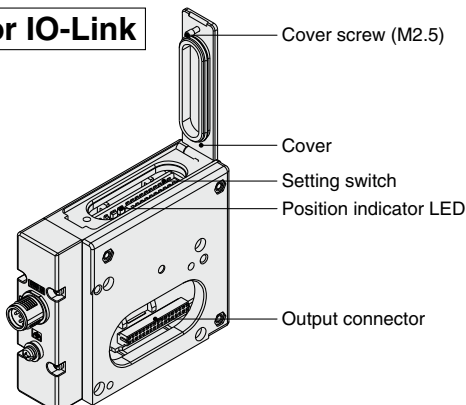

<Connector>

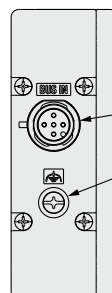

Part no.	EX260-SIL1
Communication protocol	IO-Link
Communication/ Power connector (M12)	5 pins, plug,* ¹ A code (SPEEDCON)
Ground terminal	M3

*¹ The communication line, SI unit power supply line, and the solenoid valve power supply line are connected using the same cable.

* The setting switch varies depending on the model. Refer to the operation manual for details. It can be downloaded via the SMC website: <https://www.smcworld.com>

LED Indicator

For DeviceNet™

EX260-SDN□

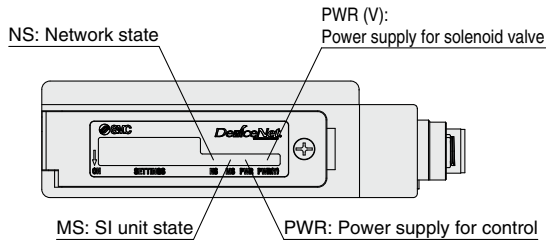

For EtherCAT

EX260-SEC□

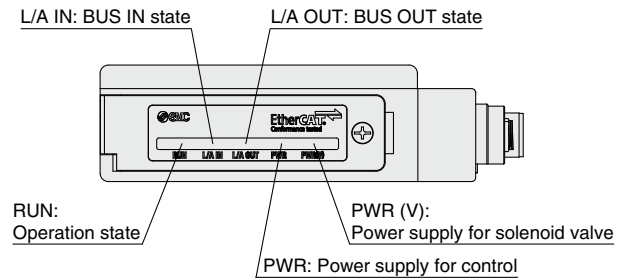

For EtherNet/IP™

EX260-SEN□

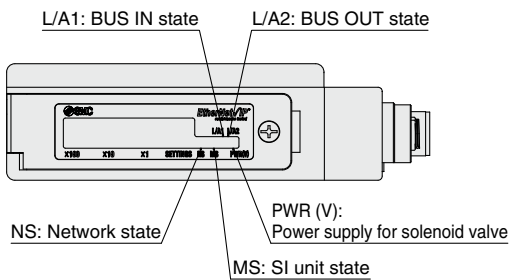

For CC-Link

EX260-SMJ□

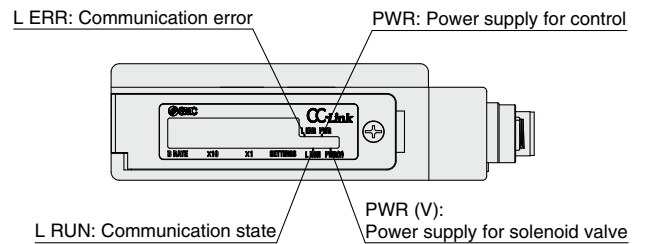

For PROFINET

EX260-SPN□

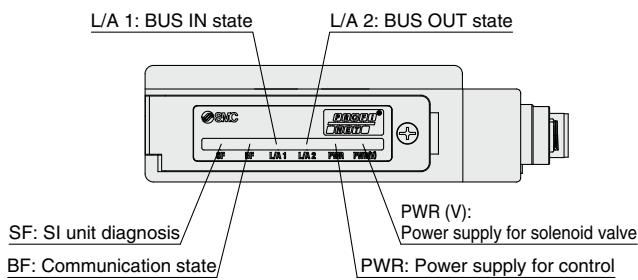

For PROFIBUS DP

EX260-SPR□

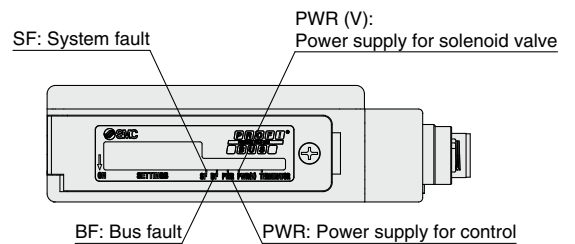

For Ethernet POWERLINK

EX260-SPL□

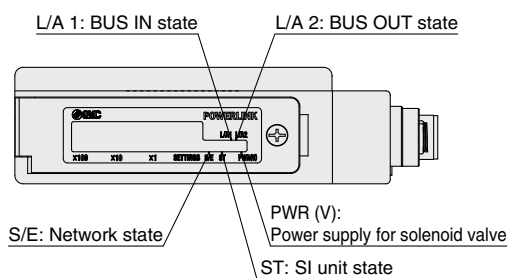

For IO-Link

EX260-SIL1

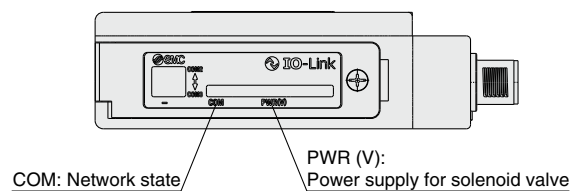

EX260 Series Accessories

① Communication Cable

For CC-Link

PCA-1567720
(Socket)

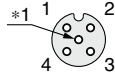

Socket connector pin arrangement
A-coded (Normal key)

*1 Number of holes: 5,
Total number of pins: 4

PCA-1567717
(Plug)



Plug connector pin arrangement
A-coded (Normal key)

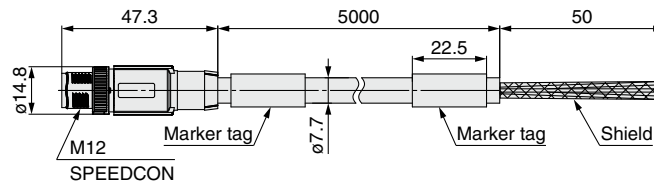
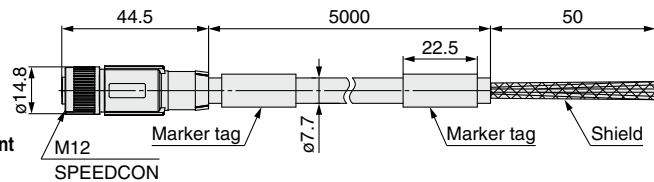

Made to Order

Cable length	10000 mm	p. 22
--------------	----------	-------

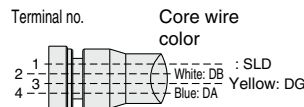

Connections

Item		Specifications
Cable O.D.		ø7.7 mm
Conductor nominal cross section	Data pair	0.5 mm ² /AWG20
	Drain	0.34 mm ² /AWG22
Wire O.D. (Including insulator)		2.55 mm
Min. bending radius (Fixed)		77 mm

EX9-AC 005 MJ-SSPS (With connector on both sides (Socket/Plug))

• Cable length (L)

005	500 mm
010	1000 mm
020	2000 mm
030	3000 mm
050	5000 mm
100	10000 mm

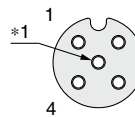
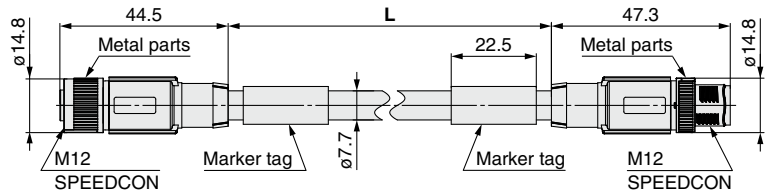

Socket connector pin arrangement
A-coded (Normal key)

*1 Number of holes: 5,
Total number of pins: 4

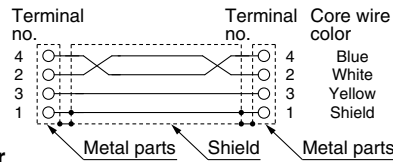

Connections

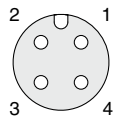

Plug connector pin arrangement
A-coded (Normal key)

Item		Specifications
Cable O.D.		ø7.7 mm
Conductor nominal cross section	Data pair	0.5 mm ² /AWG20
	Drain	0.34 mm ² /AWG22
Wire O.D. (Including insulator)		2.55 mm
Min. bending radius (Fixed)		77 mm

EX9-AC 005 MJ-SAPA (With angled connector on both sides (Socket/Plug))

• Cable length (L)

005	500 mm
010	1000 mm
020	2000 mm
030	3000 mm
050	5000 mm
100	10000 mm

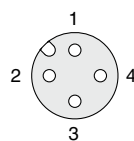
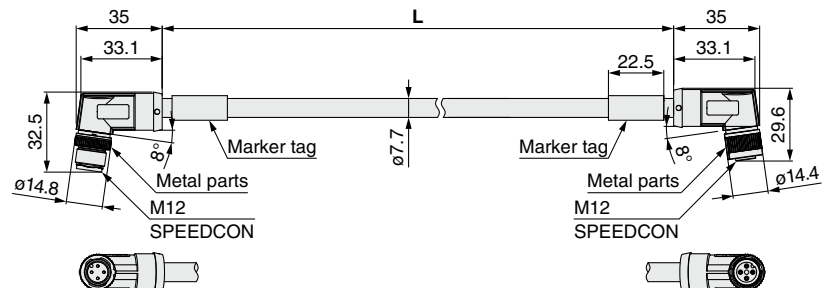

Plug connector pin arrangement
A-coded (Normal key)

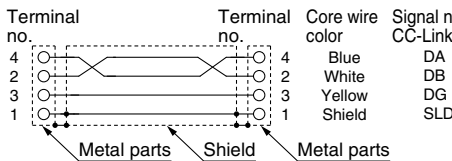

Connections

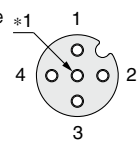

Socket connector pin arrangement
A-coded (Normal key)

*1 Number of holes: 5,
Total number of pins: 4

Item		Specifications
Cable O.D.		ø7.7 mm
Conductor nominal cross section	Data pair	0.5 mm ² /AWG20
	Drain	0.34 mm ² /AWG22
Wire O.D. (Including insulator)		2.55 mm
Min. bending radius (Fixed)		77 mm

1 Communication Cable

For DeviceNet™

PCA-1557633
(Socket)

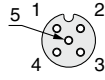

Socket connector pin arrangement A-coded (Normal key)

PCA-1557646
(Plug)

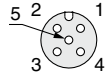

Plug connector pin arrangement A-coded (Normal key)

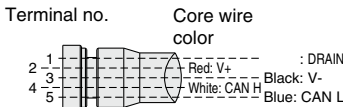
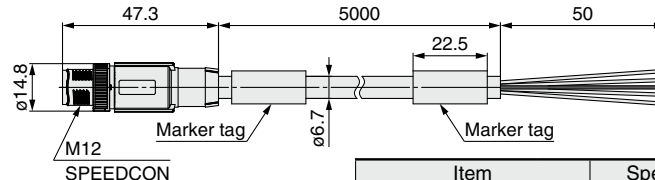
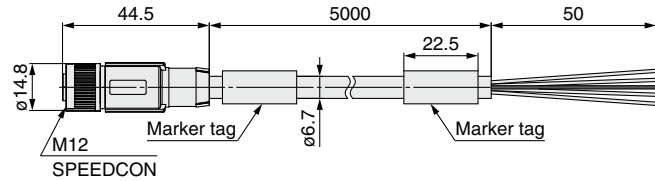

Connections

Item		Specifications
Cable O.D.		ø6.7 mm
Conductor nominal cross section	Power pair	0.34 mm ² /AWG22
	Data pair	0.25 mm ² /AWG24
Wire O.D. (Including insulator)	Power pair	1.4 mm
	Data pair	2.05 mm
Min. bending radius (Fixed)		67 mm



Made to Order

Cable length	10000 mm	p. 22
--------------	----------	-------

EX9-AC 005 DN-SSPS (With connector on both sides (Socket/Plug))

• Cable length (L)

005	500 mm
010	1000 mm
020	2000 mm
030	3000 mm
050	5000 mm
100	10000 mm

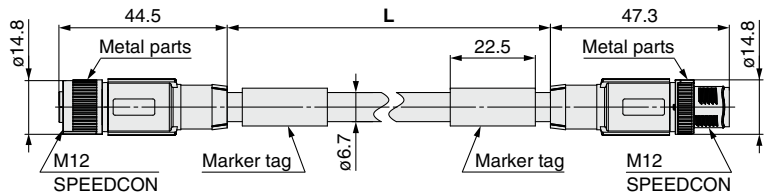

Item		Specifications
Cable O.D.		ø6.7 mm
Conductor nominal cross section	Power pair	0.34 mm ² /AWG22
	Data pair	0.25 mm ² /AWG24
Wire O.D. (Including insulator)	Power pair	1.4 mm
	Data pair	2.05 mm
Min. bending radius (Fixed)		67 mm

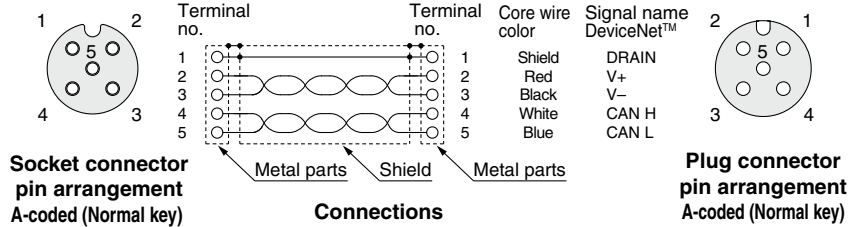

Socket connector pin arrangement A-coded (Normal key)

Plug connector pin arrangement A-coded (Normal key)

EX9-AC 005 DN-SAPA (With angled connector on both sides (Socket/Plug))

• Cable length (L)

005	500 mm
010	1000 mm
020	2000 mm
030	3000 mm
050	5000 mm
100	10000 mm

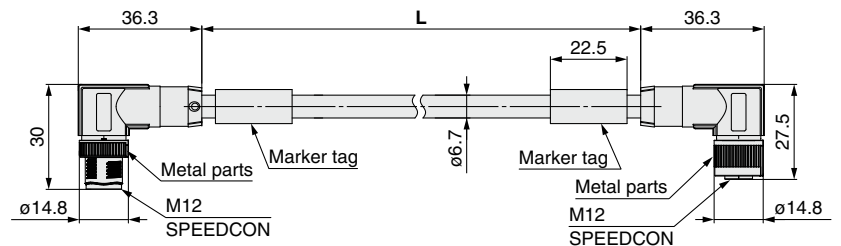

Item		Specifications
Cable O.D.		ø6.7 mm
Conductor nominal cross section	Power pair	0.34 mm ² /AWG22
	Data pair	0.25 mm ² /AWG24
Wire O.D. (Including insulator)	Power pair	1.4 mm
	Data pair	2.05 mm
Min. bending radius (Fixed)		67 mm

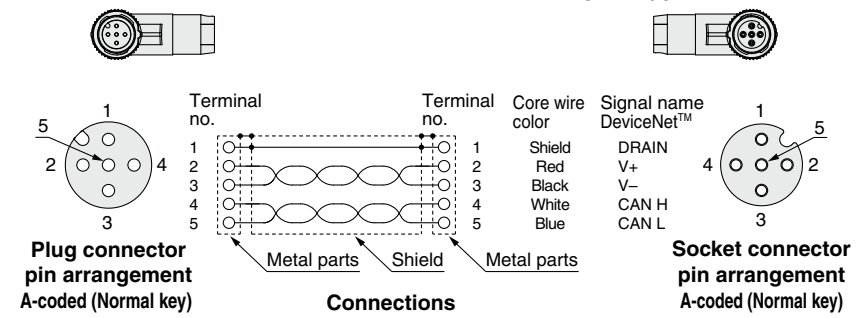

Plug connector pin arrangement A-coded (Normal key)

Socket connector pin arrangement A-coded (Normal key)

EX260 Series

① Communication Cable

For PROFIBUS DP

PCA-1557688
(Socket)

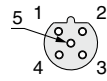

Socket connector pin arrangement B-coded (Reverse key)

PCA-1557691
(Plug)

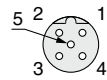

Plug connector pin arrangement B-coded (Reverse key)

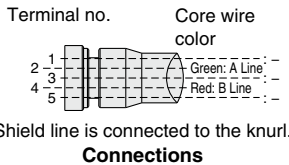
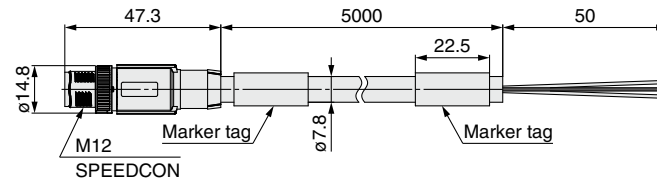
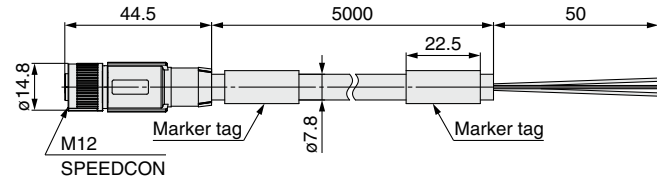

Item	Specifications
Cable O.D.	ø7.8 mm
Conductor nominal cross section	0.34 mm ² /AWG22
Wire O.D. (Including insulator)	2.55 mm
Min. bending radius (Fixed)	78 mm

For EtherCAT For PROFINET For EtherNet/IP™ For Ethernet POWERLINK

EX9-AC 020 EN-PSRJ (Plug/RJ-45 connector)

• **Cable length (L)**

010	1000 mm
020	2000 mm
030	3000 mm
050	5000 mm
100	10000 mm

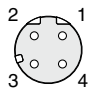
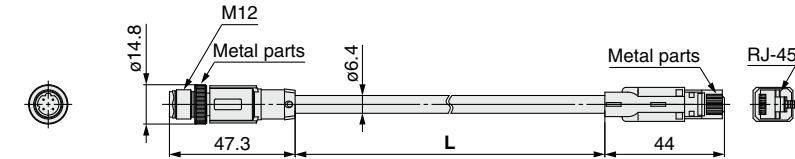

Plug connector pin arrangement D-coded

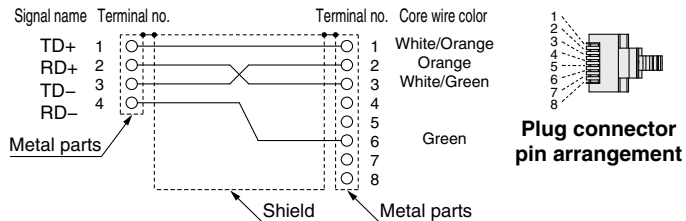

Connections (Straight cable)

Item	Specifications
Cable O.D.	ø6.4 mm
Conductor nominal cross section	0.14 mm ² /AWG26
Wire O.D. (Including insulator)	0.98 mm
Min. bending radius (Fixed)	26 mm

PCA-1446566 (Plug)

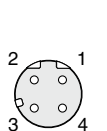

Plug connector pin arrangement D-coded

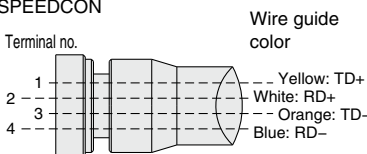
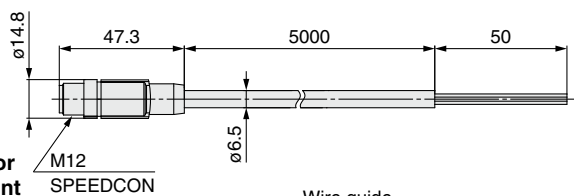

Connections

Item	Specifications
Cable O.D.	ø6.5 mm
Conductor nominal cross section	0.34 mm ² /AWG22
Wire O.D. (Including insulator)	1.55 mm
Min. bending radius (Fixed)	19.5 mm

① Communication Cable

For EtherCAT For PROFINET For EtherNet/IP™ For Ethernet POWERLINK

EX9-AC 005 EN-PSPS (With connector on both sides (Plug/Plug))

• Cable length (L)

005	500 mm
010	1000 mm
020	2000 mm
030	3000 mm
050	5000 mm
100	10000 mm

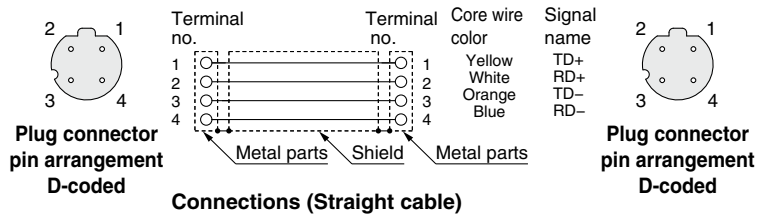
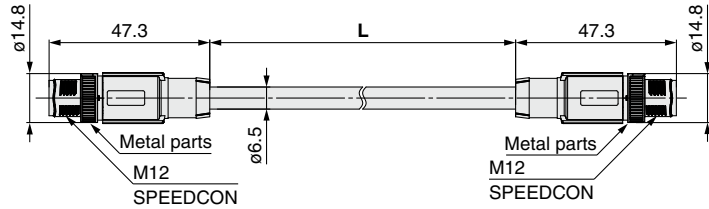

Item	Specifications
Cable O.D.	ø6.5 mm
Conductor nominal cross section	0.34 mm ² /AWG22
Wire O.D. (Including insulator)	1.55 mm
Min. bending radius (Fixed)	19.5 mm

EX9-AC 005 EN-PAPA (With angled connector on both sides (Plug/Plug))

• Cable length (L)

005	500 mm
010	1000 mm
020	2000 mm
030	3000 mm
050	5000 mm
100	10000 mm

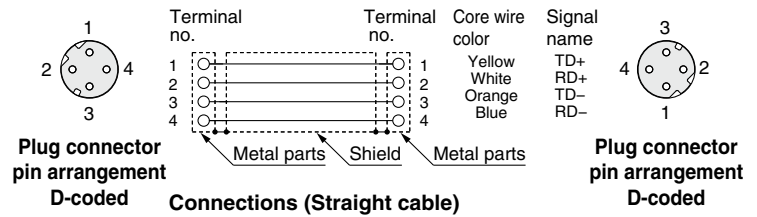
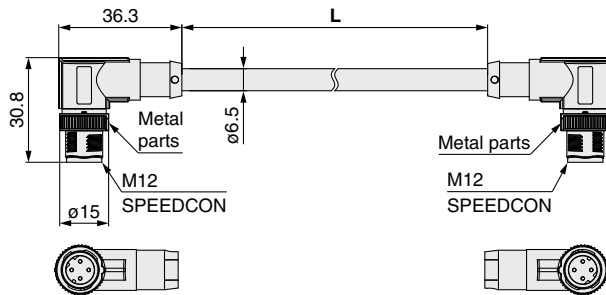

Item	Specifications
Cable O.D.	ø6.5 mm
Conductor nominal cross section	0.34 mm ² /AWG22
Wire O.D. (Including insulator)	1.55 mm
Min. bending radius (Fixed)	19.5 mm

EX260 Series

① Communication Cable

For IO-Link

Example of Connection

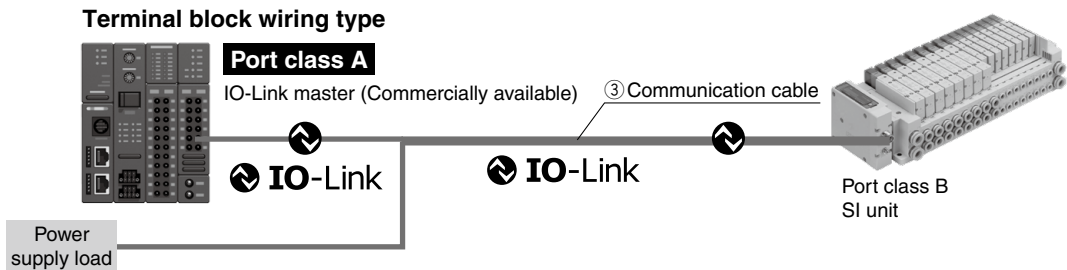
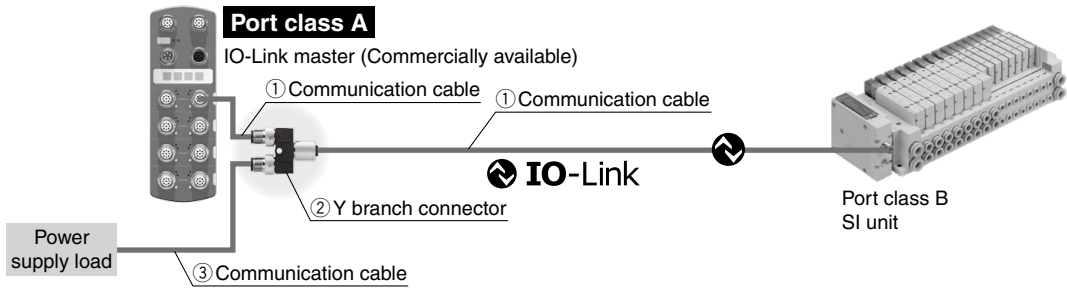
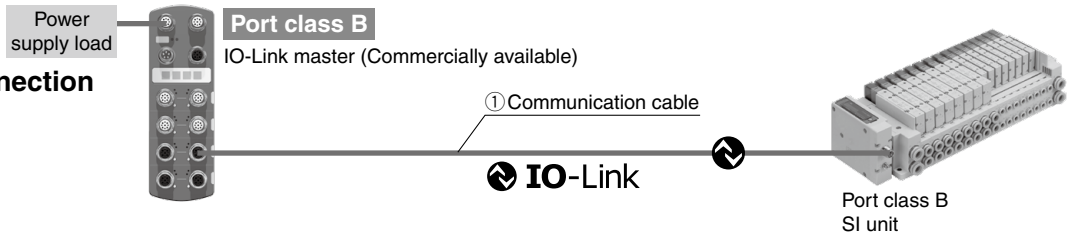

① Communication Cable

EX9-AC 005 -SSPS (With connector on both sides (Socket/Plug))

• Cable length (L)

005	500 mm
010	1000 mm
020	2000 mm
030	3000 mm
050	5000 mm
100	10000 mm

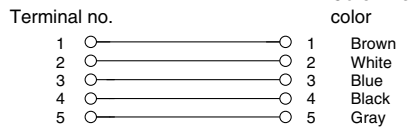
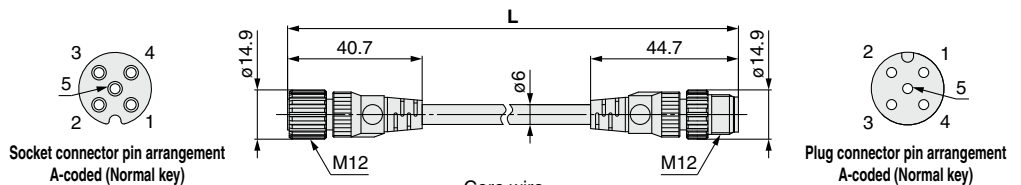

Connections

Item	Specifications
Cable O.D.	ø6 mm
Conductor nominal cross section	0.3 mm ² /AWG22
Wire O.D. (Including conductor)	1.5 mm
Min. bending radius (Fixed)	40 mm

EX9-AC 005 -SAPA (With connector on both sides (Socket/Plug))

• Cable length (L)

005	500 mm
010	1000 mm
020	2000 mm
030	3000 mm
050	5000 mm
100	10000 mm

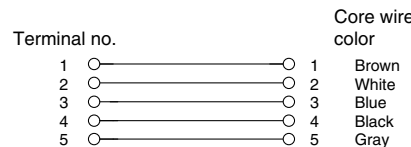
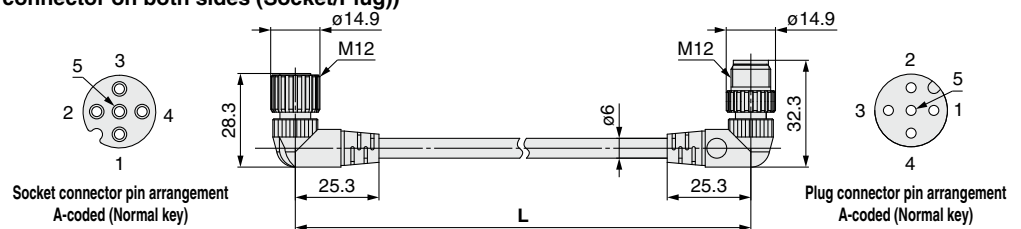

Connections

Item	Specifications
Cable O.D.	ø6 mm
Conductor nominal cross section	0.3 mm ² /AWG22
Wire O.D. (Including conductor)	1.5 mm
Min. bending radius (Fixed)	40 mm

① Communication Cable

For IO-Link

② Y branch connector

This connector is used to supply power to the valve manifold by branching the IO-Link communication cable in cases where a port class A IO-Link master is used.

EX9-ACY02-S

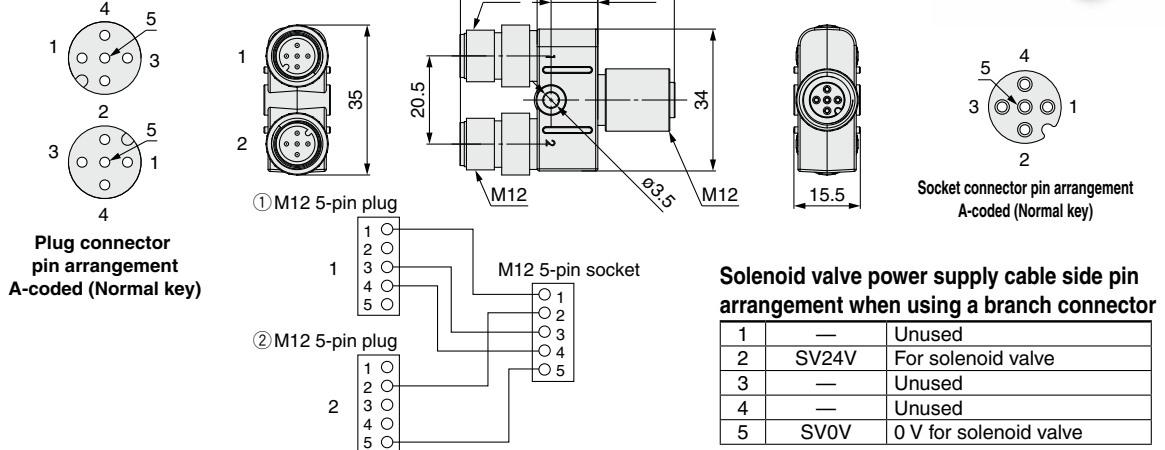

③ Communication cable

EX500-AP 050 -S

Cable length (L)		Connector specification	
010	1000 mm	S	Straight
050	5000 mm	A	Angled

Straight connector type

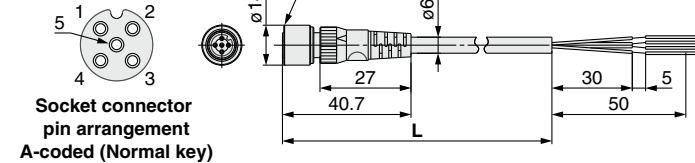

Item	Specifications
Cable O.D.	ø6 mm
Conductor nominal cross section	0.3 mm ² /AWG22
Wire O.D. (Including insulator)	1.5 mm
Min. bending radius (Fixed)	40 mm

Angled connector type

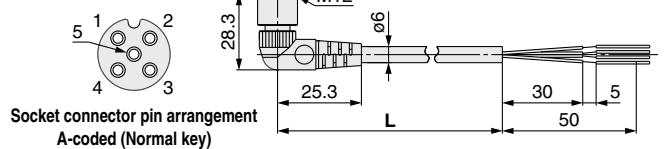

Item	Specifications
Cable O.D.	ø6 mm
Conductor nominal cross section	0.3 mm ² /AWG22
Wire O.D. (Including insulator)	1.5 mm
Min. bending radius (Fixed)	40 mm



Made to Order

Cable length	10000 mm	p. 23
--------------	----------	-------

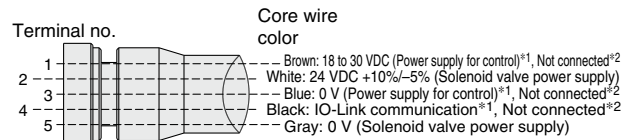

Connections (IO-Link)

*1 When used as an IO-Link communication cable
*2 When used as a solenoid valve power supply cable

PCA-1401804

Cable length (L)	
1401804	1500 mm
1401805	3000 mm
1401806	5000 mm

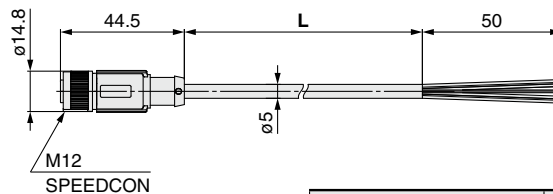
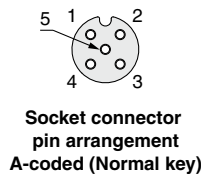

Item	Specifications
Cable O.D.	ø5 mm
Conductor nominal cross section	0.34 mm ² /AWG22
Wire O.D. (Including insulator)	1.27 mm
Min. bending radius (Fixed)	21.7 mm

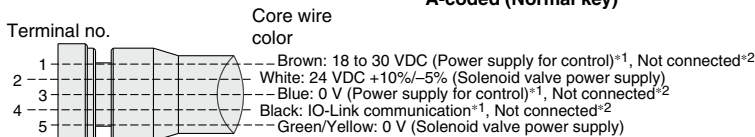

Connections (IO-Link)

*1 When used as an IO-Link communication cable *2 When used as a solenoid valve power supply cable

EX260 Series

② Field-wireable Communication Connector

Plug

For CC-Link For DeviceNet™
PCA-1075526 PCA-1075528

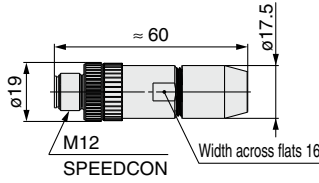

For PROFIBUS DP
PCA-1075530

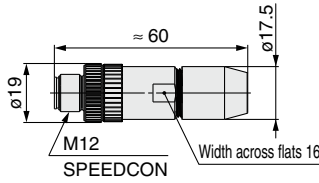

Applicable Cable

Item	Specifications
Cable O.D.	4.0 to 8.0 mm
Wire gauge (Stranded wire cross section)	0.14 to 0.75 mm ² /AWG26 to 18 (Solid cable/Flexible cable) 0.08 to 0.5 mm ² /AWG28 to 20 (With ferrule)

For EtherCAT For PROFINET For EtherNet/IP™ For Ethernet POWERLINK
PCA-1446553

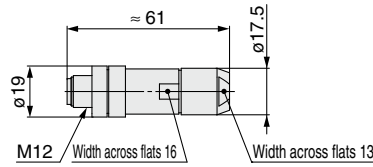
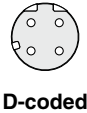

Applicable Cable

Item	Specifications
Cable O.D.	4.0 to 8.0 mm
Wire gauge (Stranded wire cross section)	0.14 to 0.34 mm ² /AWG26 to 22

* The table above shows the specifications for the applicable cable. Adaptation for the connector may vary on account of the conductor construction of the electric wire.

Socket

For CC-Link For DeviceNet™
PCA-1075527 PCA-1075529

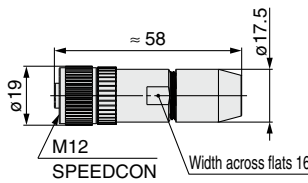

For PROFIBUS DP
PCA-1075531

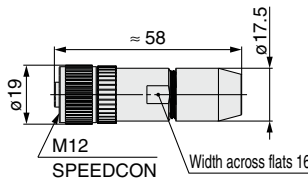

Applicable Cable

Item	Specifications
Cable O.D.	4.0 to 8.0 mm
Wire gauge (Stranded wire cross section)	0.14 to 0.75 mm ² /AWG26 to 18 (Solid cable/Flexible cable) 0.08 to 0.5 mm ² /AWG28 to 20 (With ferrule)

③ Power Supply Cable (For SI unit)

For PROFIBUS DP For DeviceNet™ For EtherCAT For PROFINET For EtherNet/IP™ For Ethernet POWERLINK

EX500-AP **050** - **S**

Cable length (L)

010	1000 mm
050	5000 mm

Connector specification

S	Straight
A	Angled

Straight connector type

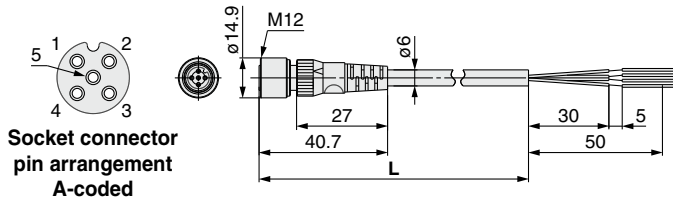

Item	Specifications
Cable O.D.	ø6 mm
Conductor nominal cross section	0.3 mm ² /AWG22
Wire O.D. (Including insulator)	1.5 mm
Min. bending radius (Fixed)	40 mm

Angled connector type

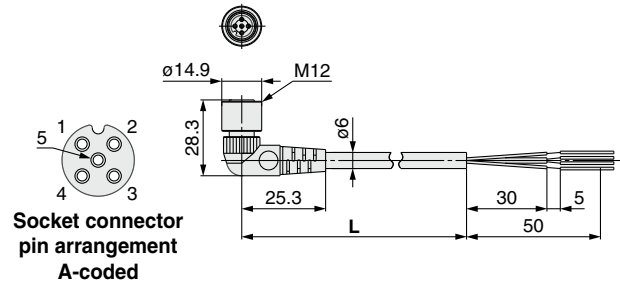

Item	Specifications
Cable O.D.	ø6 mm
Conductor nominal cross section	0.3 mm ² /AWG22
Wire O.D. (Including insulator)	1.5 mm
Min. bending radius (Fixed)	40 mm

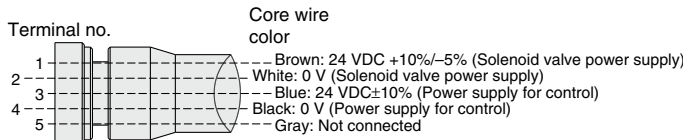

Connections (PROFIBUS DP/EtherCAT/PROFINET/Ethernet POWERLINK)

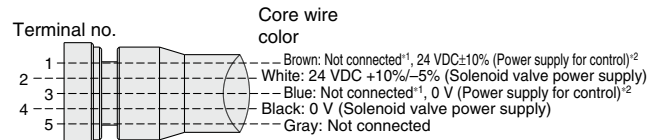

Connections (DeviceNet™, EtherNet/IP™) *1 For DeviceNet™ *2 For EtherNet/IP™



Made to Order

Cable length	10000 mm	p. 23
--------------	----------	-------

PCA- **1401804**

Cable length (L)

1401804	1500 mm
1401805	3000 mm
1401806	5000 mm

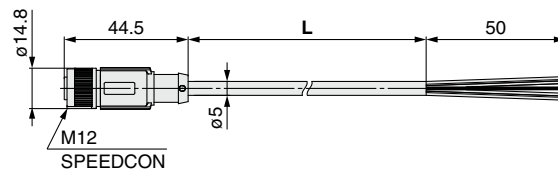
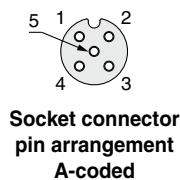

Item	Specifications
Cable O.D.	ø5 mm
Conductor nominal cross section	0.34 mm ² /AWG22
Wire O.D. (Including insulator)	1.27 mm
Min. bending radius (Fixed)	21.7 mm

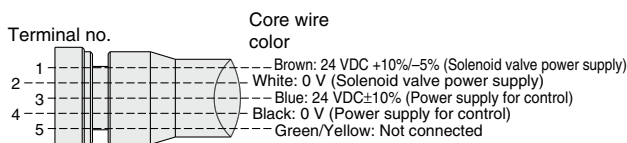

Connections (PROFIBUS DP/EtherCAT/PROFINET/Ethernet POWERLINK)

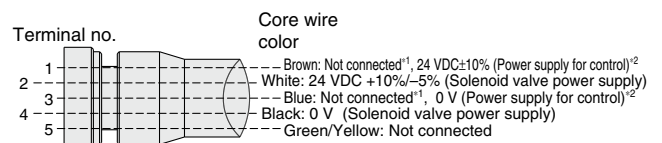

Connections (DeviceNet™, EtherNet/IP™) *1 For DeviceNet™ *2 For EtherNet/IP™

EX260 Series

④ Power Supply Cable (For SI unit/For power block)

For CC-Link For Power block

Straight connector type

EX9-AC 050 -1

● Cable length (L)

010	1000 mm
030	3000 mm
050	5000 mm

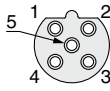

Socket connector pin arrangement B-coded

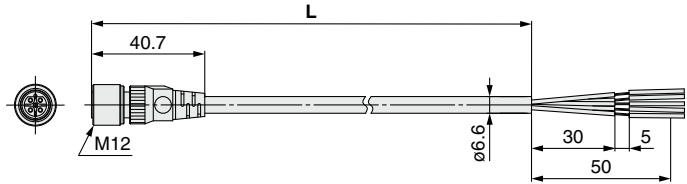

Item	Specifications
Cable O.D.	ø6.6 mm
Conductor nominal cross section	0.3 mm ² /AWG22
Wire O.D. (Including insulator)	1.65 mm
Min. bending radius (Fixed)	40 mm



Made to Order

Cable length	10000 mm	p. 23
--------------	----------	-------

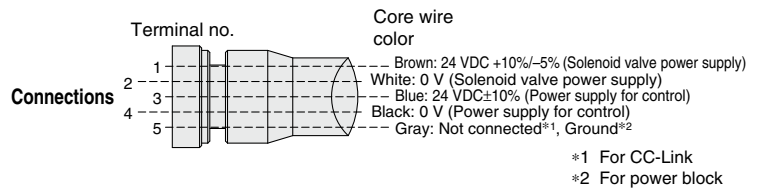

PCA-1401807

● Cable length (L)

1401807	1500 mm
1401808	3000 mm
1401809	5000 mm

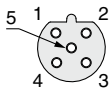

Socket connector pin arrangement B-coded

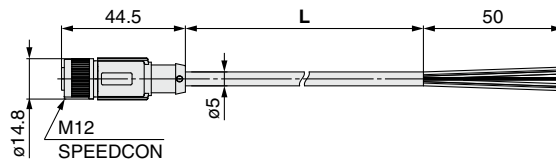

Item	Specifications
Cable O.D.	ø5 mm
Conductor nominal cross section	0.34 mm ² /AWG22
Wire O.D. (Including insulator)	1.27 mm
Min. bending radius (Fixed)	21.7 mm

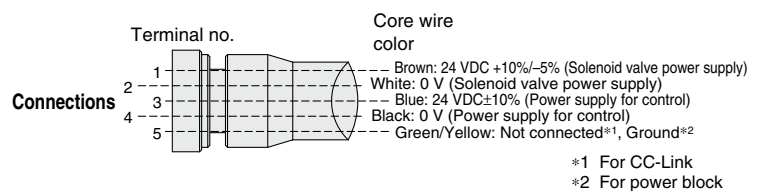

⑤ Seal Cap (10 pcs.)

Use this on ports that are not being used for communication connector (M12 connector socket). Use of this seal cap maintains the integrity of the IP67 enclosure.

* Tighten the seal cap with the prescribed tightening torque. (For M12: 0.1 N·m)

EX9-AW TS

● Connector specification

TS	For M12 connector socket (10 pcs.)
----	------------------------------------

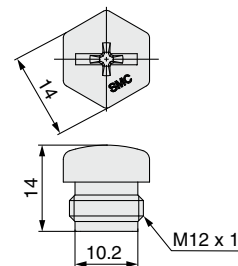

For M12 connector socket

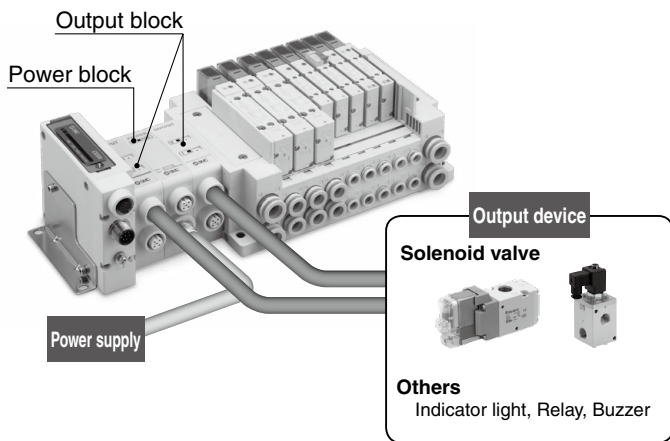

- Output devices other than valve manifold can be operated.
- By using the power block and output block for high watt load, operation up to 0.5 A/point can be performed.
- Possible to mount the output block and power block additionally between the SI unit and the solenoid valve (The surplus I/O points are used).
- 2 point outputs per output block (M12 connector)

You are requested to connect it to an SI unit and a valve manifold. For detailed specifications, refer to the operation manual that can be downloaded from SMC website, <https://www.smcworld.com>

6 Output Block

EX9-OE T 1

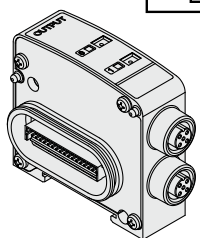

● Output specification

1	Source/PNP (Negative common)
2	Sink/NPN (Positive common)

● Power supply type

T	Internal power supply method (for low-wattage load)
P	Integrated power supply method (for high-wattage load) *1

*1 Required to connect with a power block

Dimensions/Parts Description

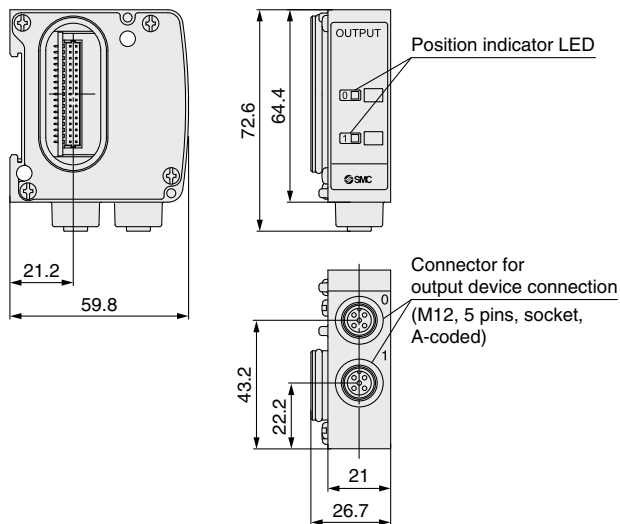

Specifications

Model	EX9-OET1	EX9-OET2	EX9-OEP1	EX9-OEP2	
Internal current consumption	40 mA or less				
Output	Output type	Source/PNP (Negative common)	Sink/NPN (Positive common)	Source/PNP (Negative common) / Sink/NPN (Positive common)	
	Number of outputs	2 outputs			
	Power supply method	Internal power supply method		Integrated power supply method (Power block: supplied from EX9-PE1)	
	Output device supply voltage	24 VDC			
	Output device supply current	Max. 42 mA/point (1.0 W/point)		Max. 0.5 A/point (12 W/point)	
Environmental resistance	Enclosure	IP67			
	Operating temperature range	-10 to 50°C			
	Operating humidity range	35 to 85%RH (No condensation)			
Standards	CE marking (EMC directive/RoHS directive), UL (CSA)				
Weight	120 g				

7 Power Block

EX9-PE1

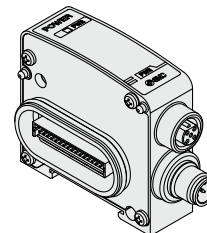

Dimensions/Parts Description

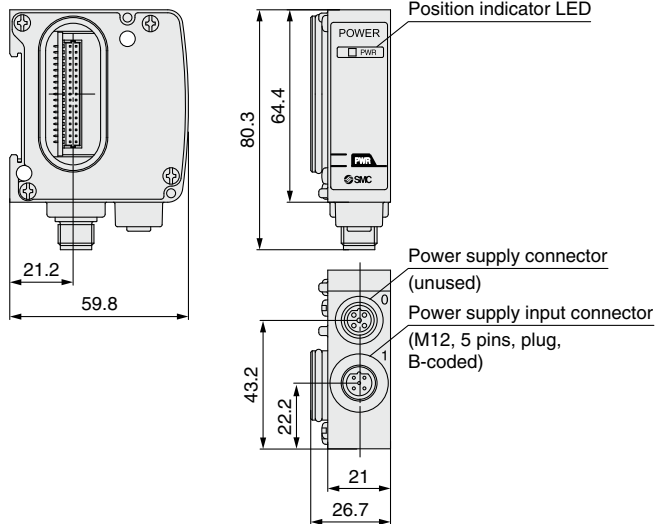

Specifications

Model	EX9-PE1	
Connection block	Output block for high wattage load	
Connection block stations	Output block: Max. 8 stations	
Power supply for output and internal control	Power supply voltage	22.8 to 26.4 VDC
	Internal current consumption	20 mA or less
Supply current	Max. 3.1 A*1	
Environmental resistance	Enclosure	IP67
	Operating temperature range	-10 to 50°C
	Operating humidity range	35 to 85%RH (No condensation)
Standards	CE marking (EMC directive/RoHS directive), UL (CSA)	
Weight	120 g	
Enclosed parts	Seal cap (for M12 connector) 1 pc.	

*1 When using with 3.0 to 3.1 A, the ambient temperature should not exceed 40°C, and do not bundle the cable.

EX260 Series

8 Connector for Output Block Wiring

Field-wireable connector for connecting an output device to an output block

PCA-1557743

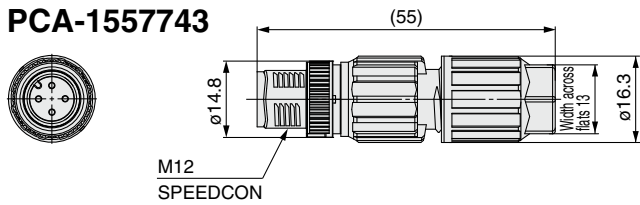

A-coded

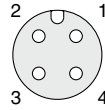

Plug pin arrangement

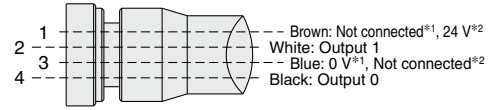

Connections

- *1 When used for EX9-OE□1
- *2 When used for EX9-OE□2

Applicable Cable

Item	Specifications
Cable O.D.	3.5 to 6.0 mm
Wire gauge (Stranded wire cross section)	0.14 to 0.34 mm ² /AWG26 to 22
Core wire diameter (Including insulating material)	0.7 to 1.3 mm

PCA-1557756

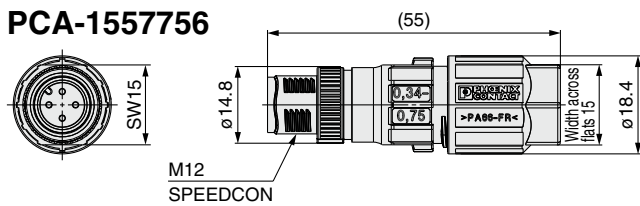

A-coded

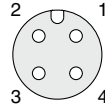

Plug pin arrangement

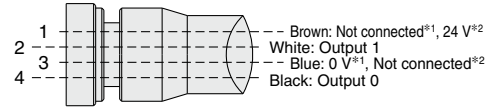

Connections

- *1 When used for EX9-OE□1
- *2 When used for EX9-OE□2

Applicable Cable

Item	Specifications
Cable O.D.	4.0 to 8.0 mm
Wire gauge (Stranded wire cross section)	0.34 to 0.75 mm ² /AWG22 to 18
Core wire diameter (Including insulating material)	1.3 to 2.5 mm

Refer to page 19 for the power supply cable for power block.

9 End Plate

Use when an output block is being used and a valve manifold is not connected.

EX9-EA03

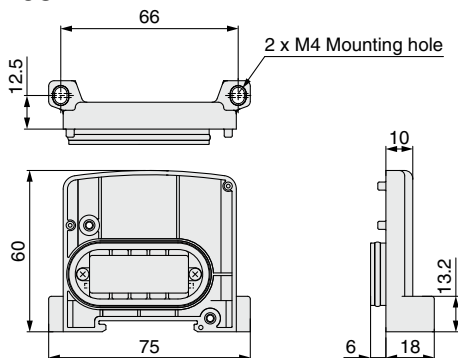

<Example of use>

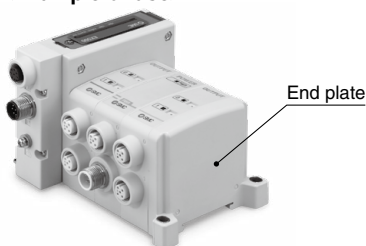

10 Bracket Plate/DIN Rail Mounting Bracket

A reinforcing brace used to mount an output block or power block onto an SI unit. To prevent connection failure between products due to deflection, use this bracket plate whenever an output block or power block is mounted.

EX9-BP1

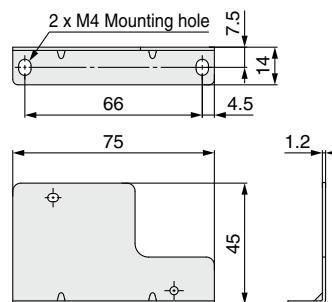

EX9-BD1 (For VQC, S0700, SV)

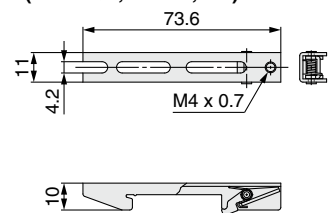

Accessory

Accessory

Description	Qty.
Hexagon socket head cap screw (M3 x 35)	2

Description	Qty.
Domed cap nut (M4)	1
Round head combination screw (M4 x 8)	1
Round head combination screw (M4 x 10)	1

<Example of use>

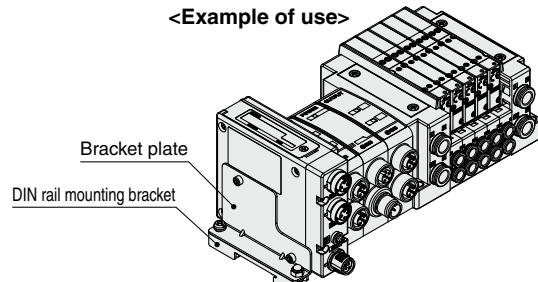

EX260 Series Made to Order

Please contact SMC for detailed specifications and lead times.



SI Unit

Prepare the SI unit and valve manifold (without SI unit) separately, and combine them before use.

EtherNet/IP™ Web server function compatible

EX260-SEN1-X194

- Web server compatible: Can conduct a solenoid valve operation test (ON/OFF), check communication state, set QuickConnect™, etc.
- Applicable to the power supply taken from Rockwell Automation's safe output module with pulse test function
- Compliant with QuickConnect™ class A specifications
- The gateway address is set to 192.168.□.001 when the IP address is set by the rotary switch.
- Dimensions are the same as those of the standard type.

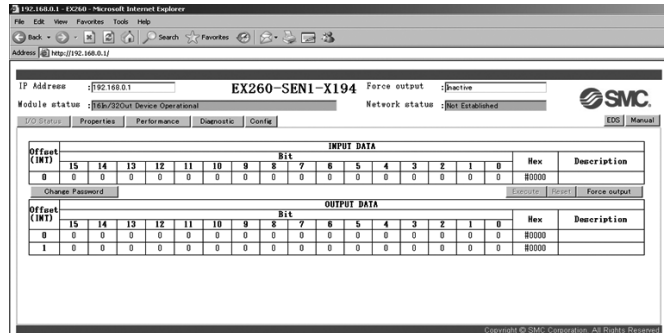

Web server screen (Example)

Communication Cable

With connector on one side (Socket)
Cable length: 10000 mm

For CC-Link

For CC-Link

For DeviceNet™

EX9-AC100 MJ-X12

• Applicable protocol

MJ	CC-Link
DN	DeviceNet™

Socket connector pin arrangement
A-coded (Normal key)

*1 Number of holes: 5, Total number of pins: 4

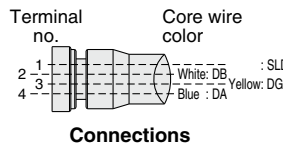
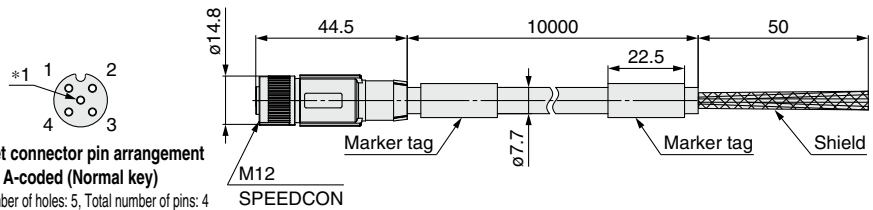

Connections

Item	Specifications	
Cable O.D.	ø7.7 mm	
Conductor nominal cross section	Data pair	0.5 mm ² /AWG20
	Drain	0.34 mm ² /AWG22
Wire O.D. (Including insulator)	2.55 mm	
Min. bending radius (Fixed)	77 mm	

For DeviceNet™

Socket connector pin arrangement
A-coded (Normal key)

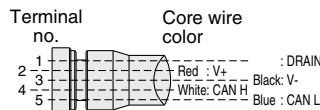
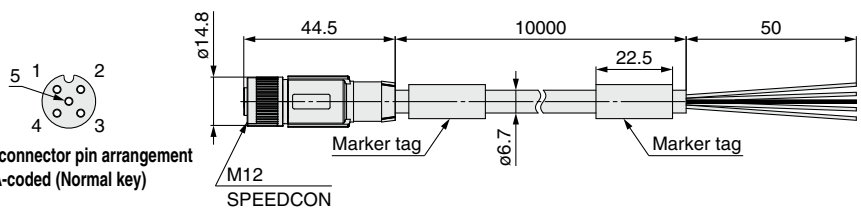

Connections

Item	Specifications	
Cable O.D.	ø6.7 mm	
Conductor nominal cross section	Power pair	0.34 mm ² /AWG22
	Data pair	0.25 mm ² /AWG24
Wire O.D. (Including insulator)	Power pair	1.4 mm
	Data pair	2.05 mm
Min. bending radius (Fixed)	67 mm	

EX260 Series

Power Supply Cable

① With connector on one side (Socket)

Cable length: 10000 mm

For CC-Link For Power block

EX9-AC100-1-X16

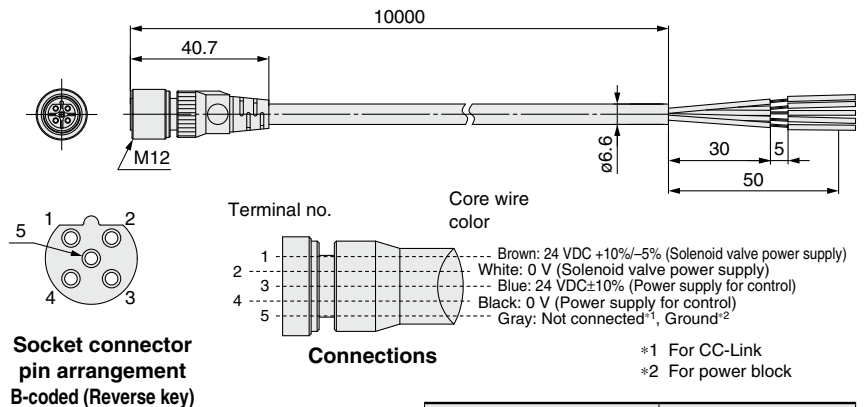

Item	Specifications
Cable O.D.	ø6.6 mm
Conductor nominal cross section	0.3 mm ² /AWG22
Wire O.D. (Including insulator)	1.65 mm
Min. bending radius (Fixed)	40 mm

② With connector on one side (Socket)

Cable length: 10000 mm

For PROFIBUS DP For DeviceNet™ For EtherCAT For PROFINET For EtherNet/IP™

For Ethernet POWERLINK For IO-Link

EX500-AP100-**S**-X1

Connector specification

S	Straight
A	Angled

Straight connector type

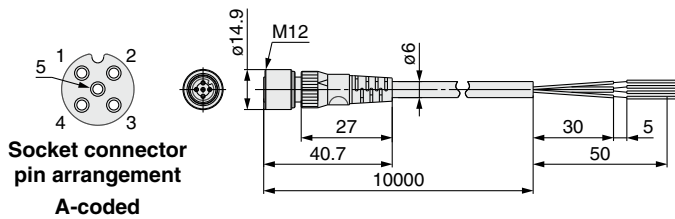

Item	Specifications
Cable O.D.	ø6 mm
Conductor nominal cross section	0.3 mm ² /AWG22
Wire O.D. (Including insulator)	1.5 mm
Min. bending radius (Fixed)	40 mm

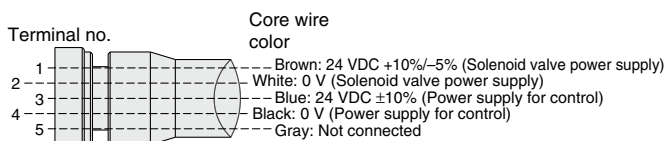

Connections (PROFIBUS DP/EtherCAT/PROFINET/Ethernet POWERLINK)

Angled connector type

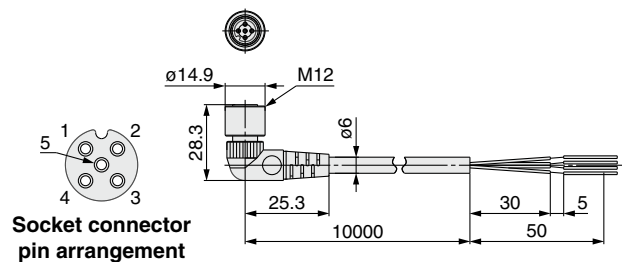

Item	Specifications
Cable O.D.	ø6 mm
Conductor nominal cross section	0.3 mm ² /AWG22
Wire O.D. (Including insulator)	1.5 mm
Min. bending radius (Fixed)	40 mm

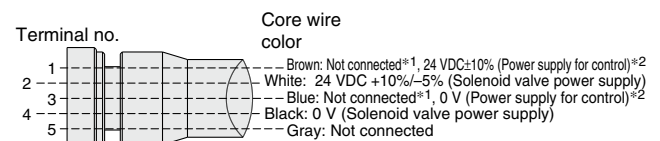

Connections (DeviceNet™, EtherNet/IP™)

*1 For DeviceNet™
*2 For EtherNet/IP™

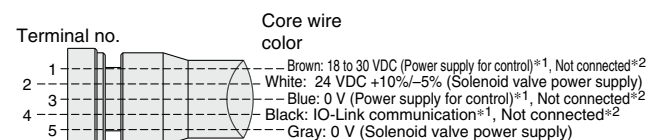

Connections (IO-Link)

*1 When used as an IO-Link communication cable
*2 When used as a solenoid valve power supply cable



EX260 Series

Specific Product Precautions

Be sure to read this before handling the products. Refer to the back cover for safety instructions. For fieldbus system precautions, refer to the “Handling Precautions for SMC Products” and the “Operation Manual” on the SMC website: <https://www.smcworld.com>

Wiring

Caution

1. **Select connectors that are $\phi 16$ or less if mounting valve manifolds directly using field-wireable connectors for SI unit power supply wiring.**

Using large diameter connectors causes interference with the mounting surface.

The following cables with connectors are recommended.

■ **For EX260-SPR□/SDN□/SEC□/SPN□/SEN□/SPL□**

<Cable with connector>

- EX500-AP□□□-□
- PCA-1401804/-1401805/-1401806

■ **For EX260-SMJ□**

<Cable with connector>

- EX9-AC□□□-1
- PCA-1401807/-1401808/-1401809

Operating Environment

Caution

1. **Select the proper type of enclosure according to the operating environment.**

IP67 is achieved when the following conditions are met.

- 1) Provide appropriate wiring between all units using electrical wiring cables, communication connectors and cables with M12 connectors.
- 2) Appropriately mount each unit and valve manifold.
- 3) Be sure to mount a seal cap on any unused connectors.

If using in an environment that is exposed to water splashes, please take measures such as using a cover.

When the enclosure is IP40, do not use in an operating environment or atmosphere where it may come in contact with corrosive gas, chemical agents, seawater, water, or water vapor.

When connected to the EX260-SPR5/6/7/8, manifold enclosure is IP40.

Adjustment / Operation

Caution

1. **For details on programming and address setting, refer to the manual from the PLC manufacturer.**

The content of programming related to protocol is designed by the manufacturer of the PLC used.

2. **For the EX260-SPN□, the side of the SI unit may become hot.**

It may cause burns.

■ Trademark

DeviceNet™ is a trademark of ODVA.

EtherNet/IP™ is a trademark of ODVA.

EtherCAT® is registered trademark and patented technology, licensed by Beckhoff Automation GmbH, Germany.

Modbus® is a registered trademark of Schneider Electric, licensed to the Modbus Organization, Inc.

QuickConnect™ is a trademark of ODVA.

Safety Instructions

These safety instructions are intended to prevent hazardous situations and/or equipment damage. These instructions indicate the level of potential hazard with the labels of “**Caution**,” “**Warning**” or “**Danger**.” They are all important notes for safety and must be followed in addition to International Standards (ISO/IEC)*1), and other safety regulations.

 **Caution:** **Caution** indicates a hazard with a low level of risk which, if not avoided, could result in minor or moderate injury.

 **Warning:** **Warning** indicates a hazard with a medium level of risk which, if not avoided, could result in death or serious injury.

 **Danger :** **Danger** indicates a hazard with a high level of risk which, if not avoided, will result in death or serious injury.

*1) ISO 4414: Pneumatic fluid power – General rules relating to systems.
ISO 4413: Hydraulic fluid power – General rules relating to systems.
IEC 60204-1: Safety of machinery – Electrical equipment of machines.
(Part 1: General requirements)
ISO 10218-1: Manipulating industrial robots – Safety.
etc.

Warning

1. The compatibility of the product is the responsibility of the person who designs the equipment or decides its specifications.

Since the product specified here is used under various operating conditions, its compatibility with specific equipment must be decided by the person who designs the equipment or decides its specifications based on necessary analysis and test results. The expected performance and safety assurance of the equipment will be the responsibility of the person who has determined its compatibility with the product. This person should also continuously review all specifications of the product referring to its latest catalog information, with a view to giving due consideration to any possibility of equipment failure when configuring the equipment.

2. Only personnel with appropriate training should operate machinery and equipment.

The product specified here may become unsafe if handled incorrectly. The assembly, operation and maintenance of machines or equipment including our products must be performed by an operator who is appropriately trained and experienced.

3. Do not service or attempt to remove product and machinery/equipment until safety is confirmed.

1. The inspection and maintenance of machinery/equipment should only be performed after measures to prevent falling or runaway of the driven objects have been confirmed.
2. When the product is to be removed, confirm that the safety measures as mentioned above are implemented and the power from any appropriate source is cut, and read and understand the specific product precautions of all relevant products carefully.
3. Before machinery/equipment is restarted, take measures to prevent unexpected operation and malfunction.

4. Contact SMC beforehand and take special consideration of safety measures if the product is to be used in any of the following conditions.

1. Conditions and environments outside of the given specifications, or use outdoors or in a place exposed to direct sunlight.
2. Installation on equipment in conjunction with atomic energy, railways, air navigation, space, shipping, vehicles, military, medical treatment, combustion and recreation, or equipment in contact with food and beverages, emergency stop circuits, clutch and brake circuits in press applications, safety equipment or other applications unsuitable for the standard specifications described in the product catalog.
3. An application which could have negative effects on people, property, or animals requiring special safety analysis.
4. Use in an interlock circuit, which requires the provision of double interlock for possible failure by using a mechanical protective function, and periodical checks to confirm proper operation.

Caution

1. The product is provided for use in manufacturing industries.

The product herein described is basically provided for peaceful use in manufacturing industries.
If considering using the product in other industries, consult SMC beforehand and exchange specifications or a contract if necessary.
If anything is unclear, contact your nearest sales branch.

Limited warranty and Disclaimer/ Compliance Requirements

The product used is subject to the following “Limited warranty and Disclaimer” and “Compliance Requirements”.

Read and accept them before using the product.

Limited warranty and Disclaimer

1. The warranty period of the product is 1 year in service or 1.5 years after the product is delivered, whichever is first.*2)
Also, the product may have specified durability, running distance or replacement parts. Please consult your nearest sales branch.
2. For any failure or damage reported within the warranty period which is clearly our responsibility, a replacement product or necessary parts will be provided.
This limited warranty applies only to our product independently, and not to any other damage incurred due to the failure of the product.
3. Prior to using SMC products, please read and understand the warranty terms and disclaimers noted in the specified catalog for the particular products.

*2) Vacuum pads are excluded from this 1 year warranty.

A vacuum pad is a consumable part, so it is warranted for a year after it is delivered.
Also, even within the warranty period, the wear of a product due to the use of the vacuum pad or failure due to the deterioration of rubber material are not covered by the limited warranty.

Compliance Requirements

1. The use of SMC products with production equipment for the manufacture of weapons of mass destruction (WMD) or any other weapon is strictly prohibited.
2. The exports of SMC products or technology from one country to another are governed by the relevant security laws and regulations of the countries involved in the transaction. Prior to the shipment of a SMC product to another country, assure that all local rules governing that export are known and followed.

Caution

SMC products are not intended for use as instruments for legal metrology.

Measurement instruments that SMC manufactures or sells have not been qualified by type approval tests relevant to the metrology (measurement) laws of each country. Therefore, SMC products cannot be used for business or certification ordained by the metrology (measurement) laws of each country.

Revision History

Edition B	* EtherNet/IP™ has been added to applicable Fieldbus protocols.	QS
Edition C	* The IO-Link compatible EX260-SIL1 has been added. * Accessories and made-to-order specifications have been added. * “How to Order Manifold” and “Dimensions” pages have been deleted. * Number of pages has been decreased from 52 to 28.	XU

Safety Instructions

Be sure to read the “Handling Precautions for SMC Products” (M-E03-3) and “Operation Manual” before use.

Fieldbus System *EX260 Series* SI Unit



LAN cable connectable RJ45 communication connectors

- Communication protocol: EtherNet/IP™
- Number of outputs: 32

LAN cable*1 connectable
RJ45 communication connectors

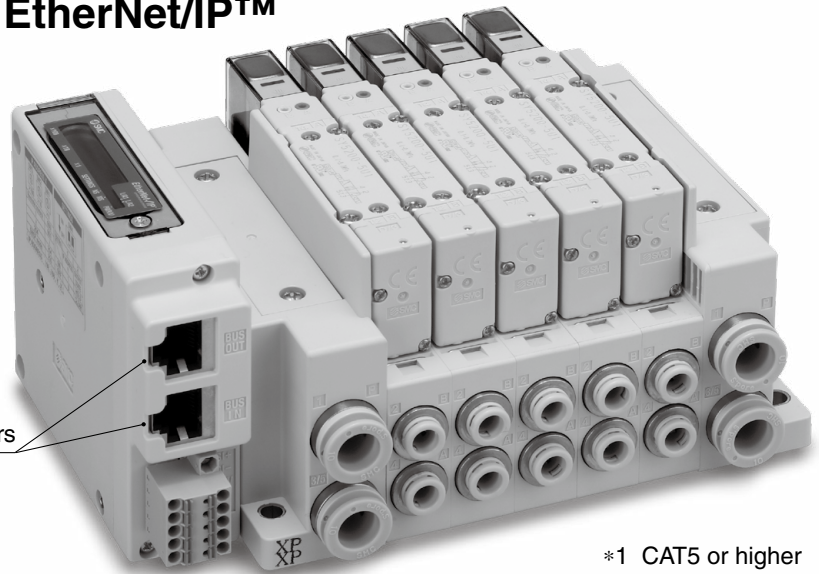

■ Trademark

EtherNet/IP™ is a trademark of ODVA.
QuickConnect™ is a trademark of ODVA.

*1 CAT5 or higher
* Enclosure: IP20

■ Applicable Valve Series

Series	Flow rate characteristics (4/2 → 5/3)		Max. number of solenoids	Power consumption [W]	Applicable cylinder size	
	C [dm ³ /(s·bar)]	b				
JSY Series*2	JSY1000	0.91	0.48	32	0.2 (With power-saving circuit)	ø40
	JSY3000	2.77	0.27		0.4 (Standard)	ø50
	JSY5000	6.59	0.22		0.1 (With power-saving circuit)	ø80
SY Series	SY3000	1.6	0.19	32	0.35 (Standard) 0.1 (With power-saving circuit)	ø50
	SY5000	3.6	0.17			ø63
	SY7000	5.9	0.20			ø80
VQC Series*2	VQC1000	1.0	0.30	24	0.4 (Standard)	ø40
	VQC2000	3.2	0.30			ø63
	VQC4000	7.3	0.38		0.95 (Standard) 0.4 (Low-wattage type)	ø160
	VQC5000	17	0.31			ø180

*2 The assembly of JSY and VQC series valves should be requested separately by the customer. Specify "without SI unit" and "positive common" or "non-polar" for the valve manifold specifications.

EX260-SEN2-X205



19-E731

EX260-SEN2-X205

■ **Daisy-chain wiring of communication cables and power supply cables is possible.**

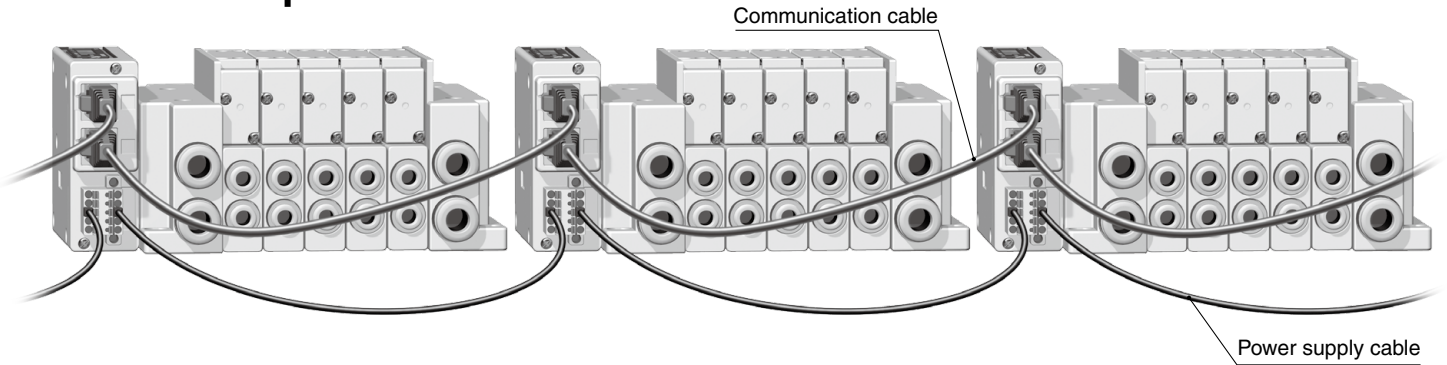

Compatible Topologies

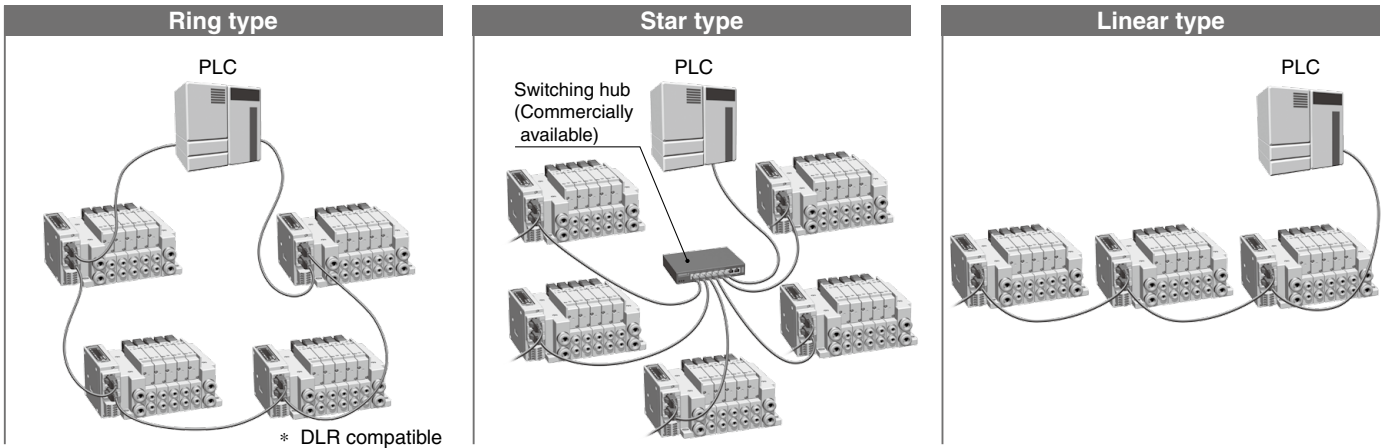

■ **Both air and electric systems can be constructed with RJ45 communication cables.**

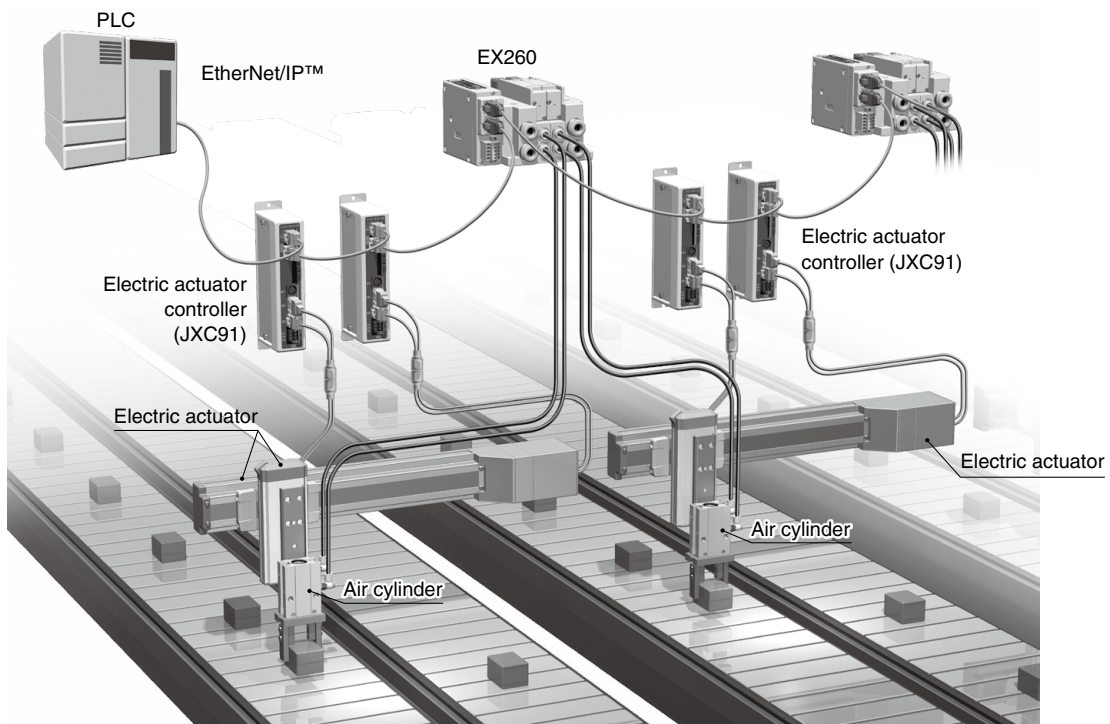

How to Order SI Units



EX260-S EN2-X205

Communication protocol

EN EtherNet/IP™

Connector specification

X205 Communication connector: RJ45
Power connector: Spring type connector

Output specification

2 32 outputs, NPN (Positive common)/Sink

Specifications

Item	Specifications	
Protocol	EtherNet/IP™ Volume 1 (Edition 3.25) Volume 2 (Edition 1.23)	
Transmission medium	Standard Ethernet cable (CAT5 or higher) (100BASE-TX)	
Transmission speed	100 Mbps/10 Mbps (Automatic negotiation)	
Transmission method	Full duplex/Half duplex (Automatic negotiation)	
Device information	Vendor ID: 7 (SMC Corp.) Device type: 27 (Pneumatic Valve)	
Applicable function	QuickConnect™ DLR	
EDS file	ex260_sen2_X205_24_v*.eds	
Output	Number of outputs	32
	Output type	Sink/NPN (Positive common)
	Connected load	Solenoid valve with surge voltage suppressor of 24 VDC and 1.5 W or less (manufactured by SMC)
	Power supply for solenoid valve	22.8 to 26.4 VDC 2.0 A or less, according to the solenoid valve station specification
	Residual voltage	0.4 VDC or less
Power supply for control	21.6 to 26.4 VDC 0.1 A or less	
Enclosure	IP20 (with manifold assembled)	
Weight	200 g or less (including accessories)	

EtherNet/IP™ communication connector
BUS OUT: RJ45 8 pins, socket



No.	Designation	No.	Designation
1	Tx+	5	-
2	Tx-	6	Rx-
3	Rx+	7	-
4	-	8	-

EtherNet/IP™ communication connector
BUS IN: RJ45 8 pins, socket



No.	Designation	No.	Designation
1	Tx+	5	-
2	Tx-	6	Rx-
3	Rx+	7	-
4	-	8	-

Accessory

Description	Qty.
Hexagon socket head cap screw (M3 x 30)	2
RJ45 cap	1
Power connector	1

Power connector PWR: 5 pins, socket

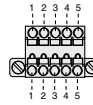

No.	Designation	Function	No.	Designation	Function
1	FE	Grounding	4	SI0V	0 V for control unit
2	SV0V	0 V for solenoid valve	5	SI24V	+24 V for control unit
3	SV24V	+24 V for solenoid valve			

Applicable wire for power supply connector

Wire gauge (Solid cable/Flexible cable)	0.2 to 1.5 mm ² /AWG24 to 16
---	---

Dimensions

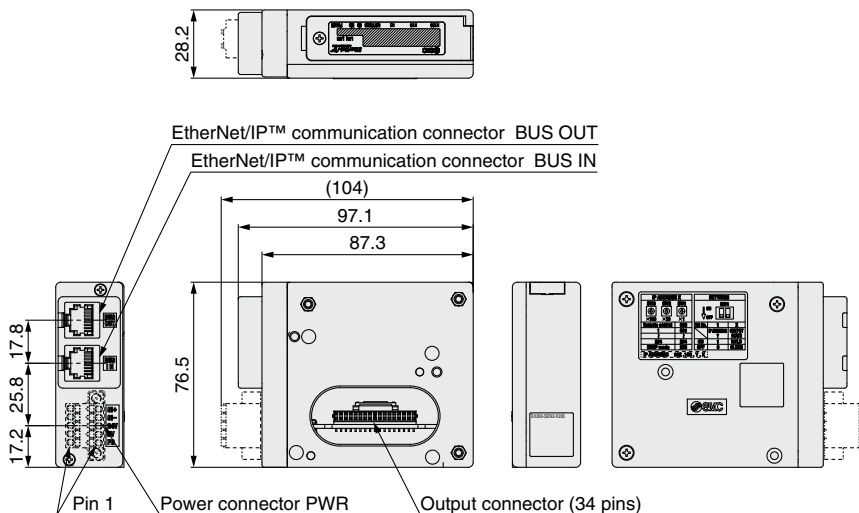

Caution

- The dimensions when combined with the valve manifold are the same as the dimensions of the valve manifold with a standard EX260 series unit mounted.
- For the JSY and VQC series, order the valve manifold separately.
Specify "without SI unit" and "positive common" or "non-polar" for the valve manifold specifications.

LED Indicator

LED	LED Status	Details
NS	OFF	Power is not being supplied or the IP address is not set.
	Green LED is ON	EtherNet/IP™ communication established
	Green LED is flashing	EtherNet/IP™ communication not established
	Red LED is flashing	EtherNet/IP™ connection time out
MS	Red LED is ON	IP duplicated
	OFF	Power is not being supplied.
	Green LED is ON	Operating normally
	Green LED is flashing	Setting error
L/A1	Red LED is flashing	Recoverable error
	Red LED is ON	Unrecoverable error
	OFF	BUS IN side: No link, No activity
L/A2	Green LED is ON	BUS IN side: Link, No activity
	Green LED is flashing	BUS IN side: Link, Activity
	OFF	BUS OUT side: No link, No activity
PWR(V)	Green LED is ON	BUS OUT side: Link, No activity
	Green LED is flashing	BUS OUT side: Link, Activity
	Yellow LED is ON	Power is being supplied to the valve.
	OFF	Power is not being supplied to the valve or is outside the tolerance range (19 V or less).

EX260-SEN2-X205

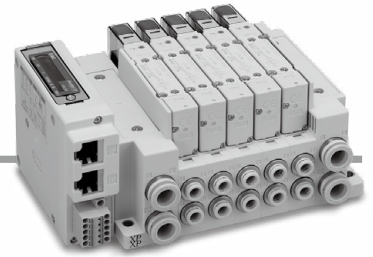

SY3000/5000/7000 Series

How to Order Manifold

Type

10	Side ported
11	Bottom ported ^{*1}

*1 The bottom-porting type is not available for the SY3000.

Side/Bottom ported

Type 10/11 SS5Y 3 - 10 SEC - 05 U [] - C6 [] - X1100

Top ported

Type 12 SS5Y 3 - 12 SEC - 05 U [] - [] [] - X1100

Valve series

3	SY3000
5	SY5000
7	SY7000

Type

12	Top ported
----	------------

Valve stations

Symbol	Stations	Note
02	2 stations	Double wiring ^{*2}
:	:	
16	16 stations	Specified layout ^{*3} (Up to 32 solenoids available)
02	2 stations	
:	:	
24	24 stations	

P, E port entry

U	U side (2 to 10 stations)
D	D side (2 to 10 stations)
B	Both sides (2 to 24 stations)

A, B port size
* Refer to the Web Catalog.

Mounting

Nil	Direct mounting
D	DIN rail mounting (with DIN rail)
D0	DIN rail mounting (without DIN rail)
D3	For 3 stations
:	:
D24	For 24 stations

Specify a length longer than that of the standard rail.

* Only direct mounting is available for the type 11 bottom-porting type.

P, E port size (One-touch fitting)

Symbol	SY3000	SY5000	SY7000
Nil	ø8	ø10	ø12
N	ø5/16"	ø3/8"	ø1/2"

* For N, sizes are in inches.

SUP/EXH block assembly

Nil	Internal pilot
S	Internal pilot, Built-in silencer
R	External pilot

* For the type 12 top-porting type, the P and E ports are only available on the U and D sides for the built-in silencer type. The silencer exhaust port is located on the opposite side of the P and E port entry. (Example: When the P and E port entry is on the D side, the silencer exhaust port is on the U side.) The 3/5(E) port on the silencer mounting side of type 10/11/12 is plugged.

* When the built-in silencer type is used, keep the exhaust port from coming into direct contact with water or other liquids.

*2 Double wiring: 2-position single, double, 3-position, and 4-position valves can be used on all manifold stations. Use of a 2-position single solenoid will result in an unused control signal. If this is not desired, order with a specified layout.

*3 Double wiring is normally used for all the wiring of the manifold. If other wiring is required, specify on the manifold specification sheet.

* Valves do not come assembled for order no. "SS5Y[]-[]SEC-[]-[]-[]-X1100." Specify on the manifold specification sheet separately to request assembly.

* Produced upon receipt of order

How to Order Valves

SY [] [] [] [] [] [] [] [] - 5 U [] 1 - []

Enter the standard product number.

Enter the standard product number.

Light/surge voltage suppressor and common specification

Symbol	With light	Surge voltage suppressor	Common specification
R	—	●	Non-polar
U	●		
S	—		
Z	●	Positive common	

⚠ Safety Instructions Be sure to read the "Handling Precautions for SMC Products" (M-E03-3) and "Operation Manual" before use.