

Fieldbus System

Select from 3 product types and 14 protocols.



* Some protocols are not UL-compliant.

- Type 1** Output type for solenoid valves
- Type 2** Gateway type
- Type 3** Integrated input-output type

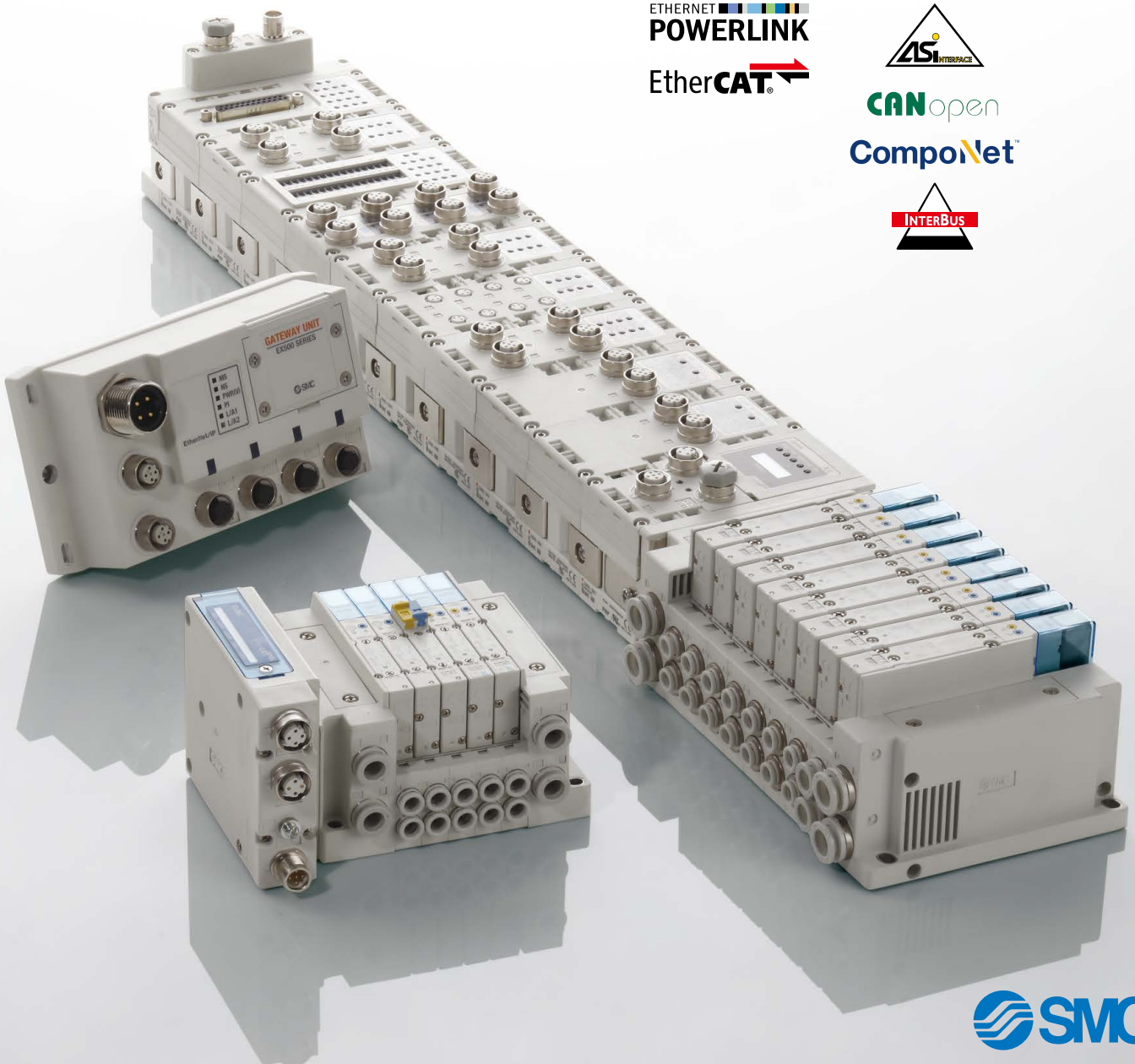
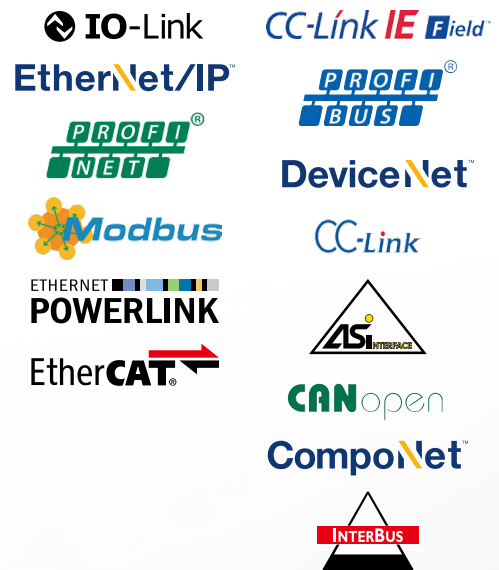

CAT.E02-27A

What is a Fieldbus (Serial Transmission)?

A Fieldbus (serial transmission) is a network communications system that uses a single communication cable to send and receive ON/OFF signals from numerous solenoid valves (from here forth “valves”), signals from auto switches, etc.

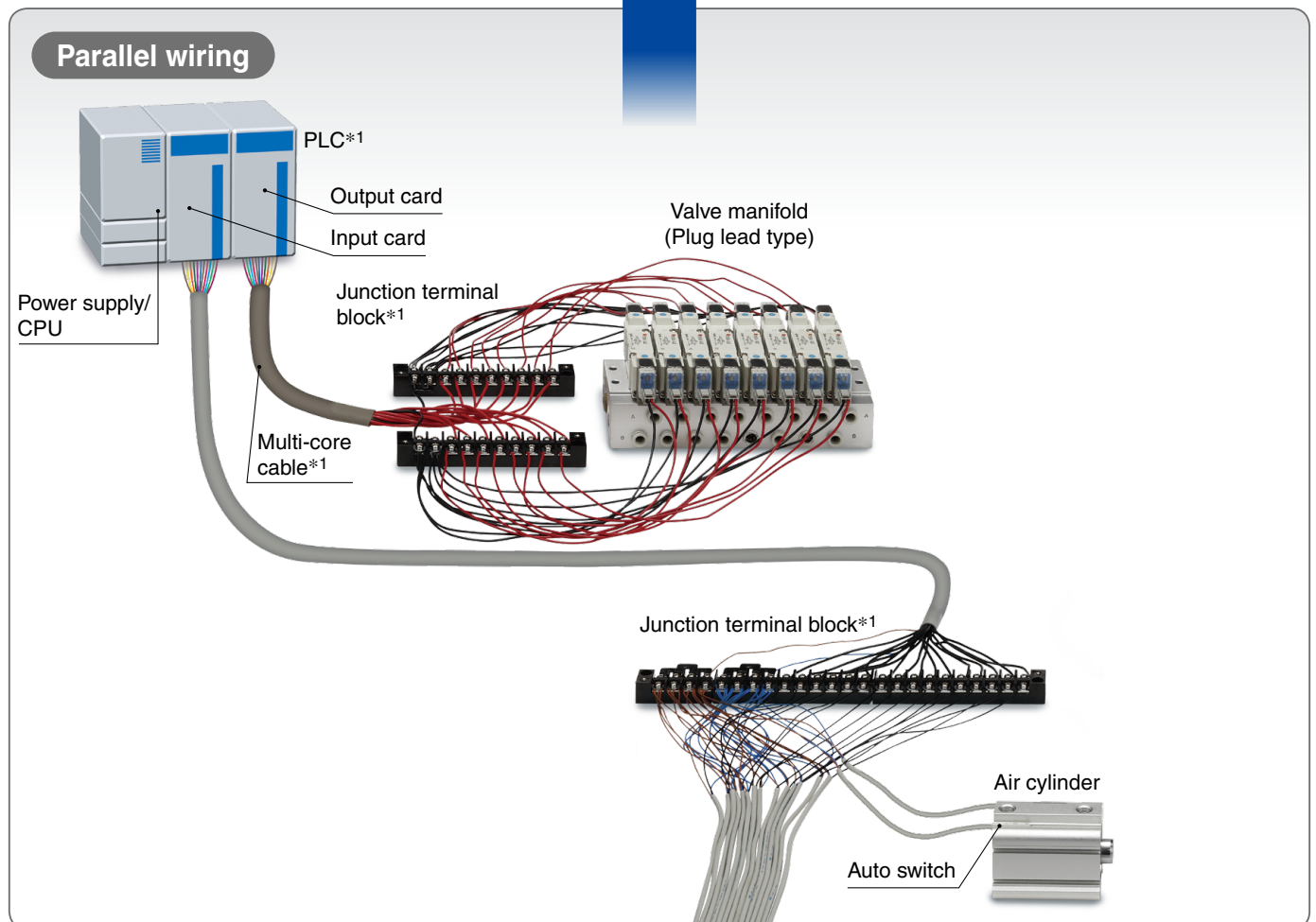
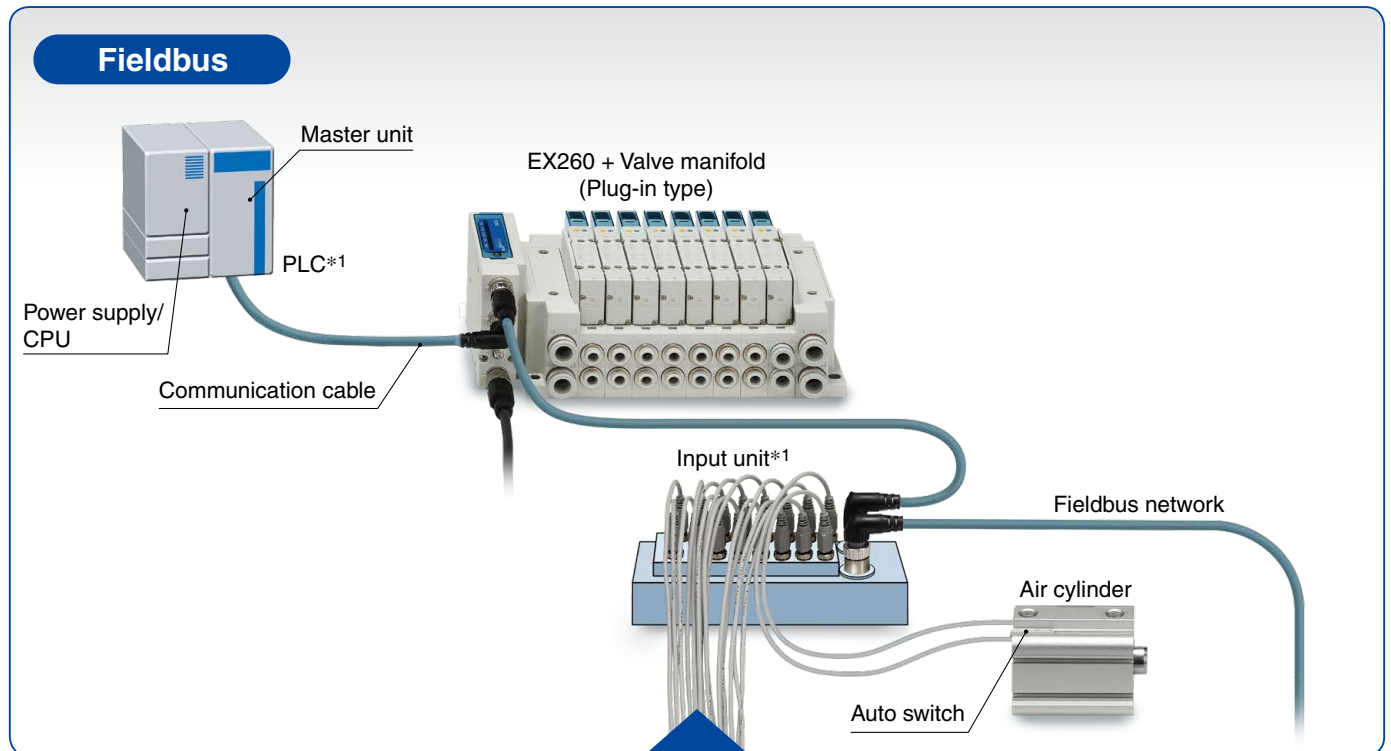

*1 Commercially available

Advantages of Using a Fieldbus

Reduced wiring labor and required wiring space

Valves can be successfully controlled by connecting the PLC and valve manifold with a single cable. The combining of multiple cables into a single cable supports equipment downsizing and simplification. When wiring the lead wire to the terminal of a D-sub connector, etc., there's no need to check pin arrangements or perform any other time-consuming tasks.

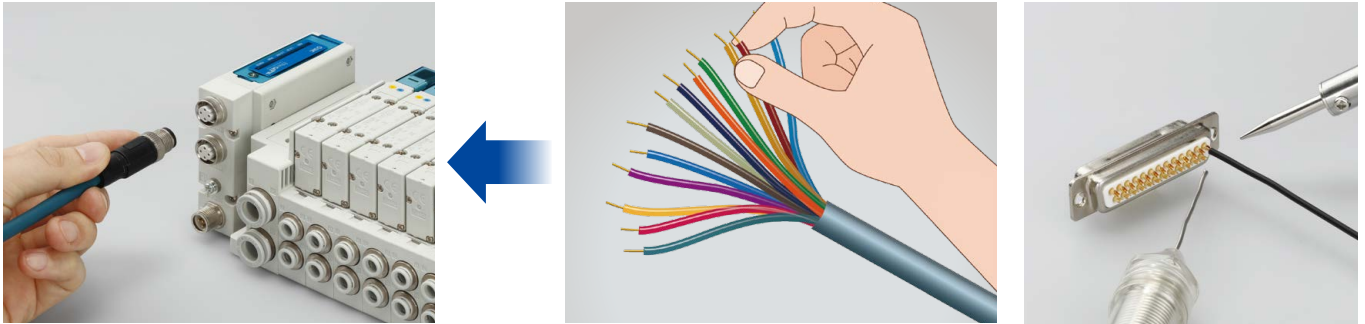

Improvement of maintenance workability

Reduced wiring labor allows for the easy replacement of faulty units, cables, etc., leading to reduced maintenance labor as well.

Increased flexibility when increasing the number of I/O points

Even when increasing the number of I/O points, there is no need for an additional PLC input/output card.

Error diagnostic function

• Error diagnosis is possible.

The error contents can be checked not only on the touch panel (PLC) but also on the product's LED display screen. When a problem occurs, a local diagnosis can provide even more detailed information.

Error contents that can be displayed on the LED screen

- Network state
- SI unit state
- Power supply state
- The disconnection/short-circuit of input devices (auto switches, etc.) and output devices (valves, etc.)

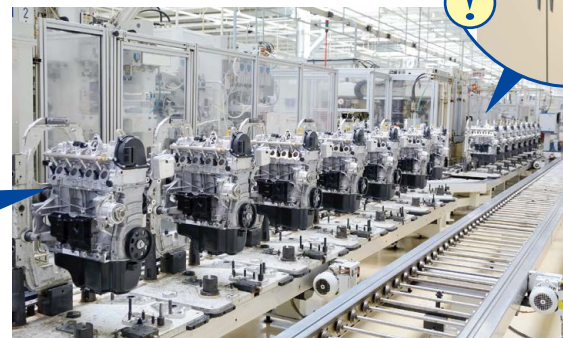
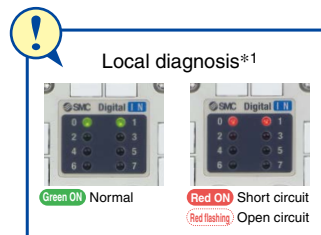

*1 Display of the EX600 series
For details, refer to page 94 and onwards.

• Comprehending the number of times the device used by the equipment has been operated

By using the counter function*1, it is possible to measure the number of times an auto switch, valve, etc., has been turned ON and OFF. This allows for the easy prediction of when maintenance should be carried out and the easy identification of which areas are in need of maintenance. Preventive maintenance and the advanced preparation of error countermeasures will allow you to reduce the amount of time the equipment will need to be out of service.



*1 Function of the EX600 series
For details, refer to page 94 and onwards. (When the counter reaches the pre-determined number, the LED display will flash in red.)

Advantages of the Fieldbus Compatible Valve Manifold (with SI Unit)

The **SI unit** is a product that makes use of the Fieldbus to control valve manifolds, etc.

When using an SI unit to control valves

As the Fieldbus interface (SI unit) is linked with the valve manifolds, an output unit is not necessary. Also, there is no need to prepare multi-core cables (D-sub connector, MIL connector, multi-connector) and branch connectors separately.

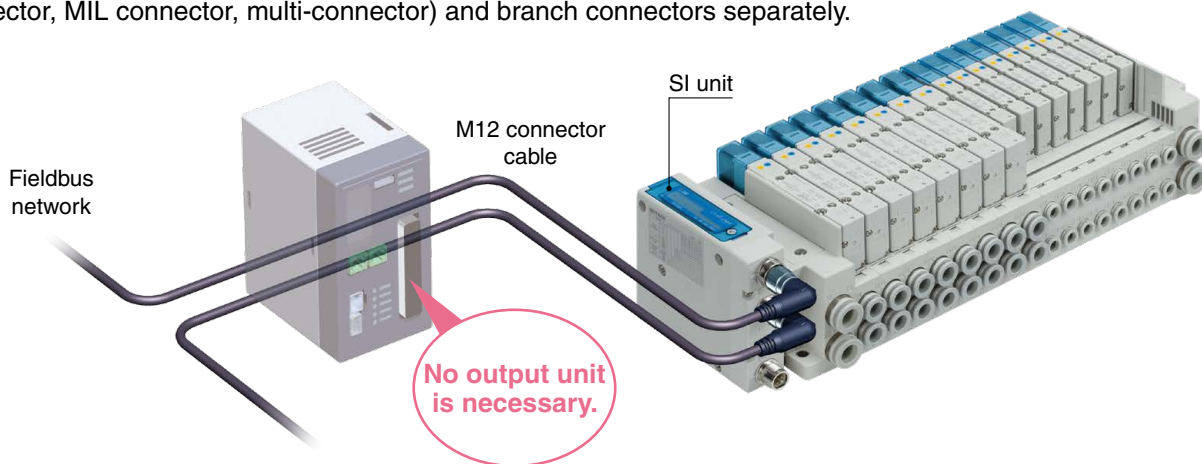

Reduction of installation space

Since an output unit is not necessary, the space required for installation can be greatly reduced.

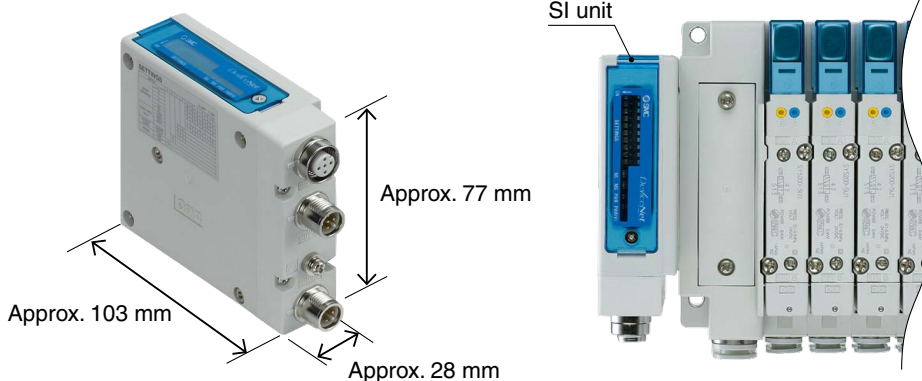

Reduced product selection/ordering labor

Valve manifolds and SI units can be ordered together. The required cables, connectors, accessories, etc., can also be ordered together.

* For details on cables, connectors, and other types of accessories, refer to page 216 and onwards.

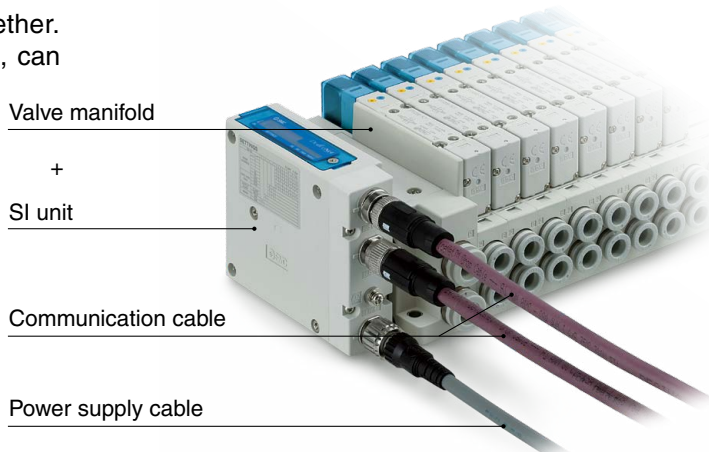

When using a Fieldbus compatible output unit to control valves

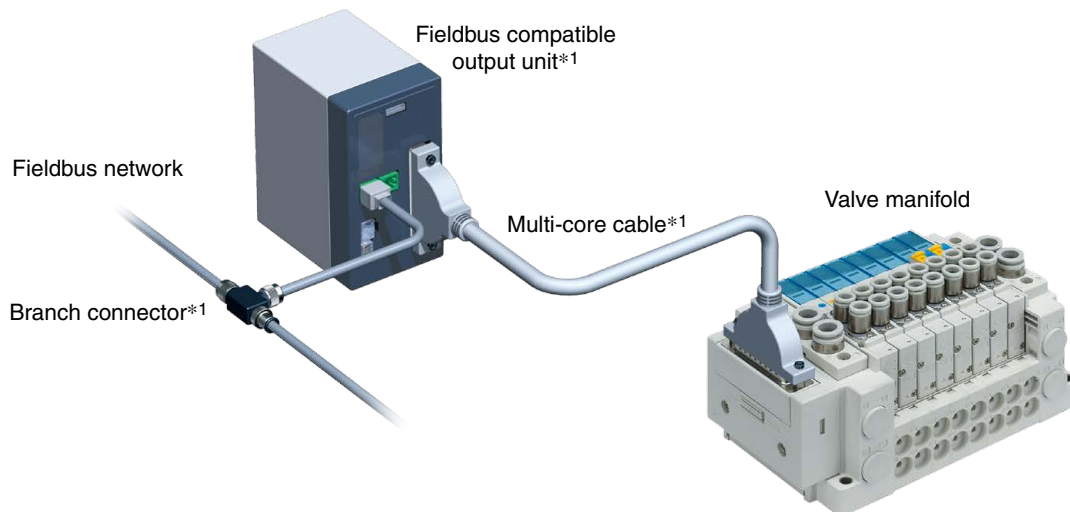

*1 Commercially available

Now with an improved enclosure: IP65/67

M12 connector type products
Enclosure: IP65/67

D-sub connector type products
Enclosure: IP40

The product does not need to be stored in a waterproof case, and it can be installed even in locations where water splashing occurs.

* The enclosure may differ according to the Fieldbus. For details, refer to pages 13 and 14.

* Please confirm the enclosure of the valves as well. For details, refer to each individual product of the EX series.

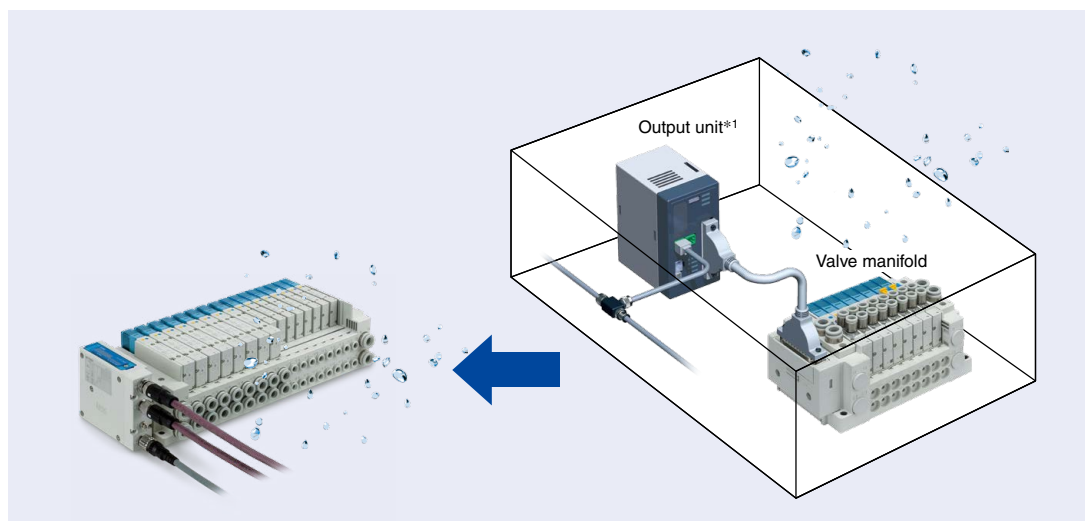

*1 Commercially available

Product Series Featuring 3 Types Suitable to a Variety of Equipment/Facility Layouts

Type 1 Output type for solenoid valves

- When decentralized arrangement of valve manifolds is desired
- When installing valve manifolds close to the cylinder/actuator due to minimal space
- Number of inputs/outputs: Small (Example: EX260 series [32 outputs])

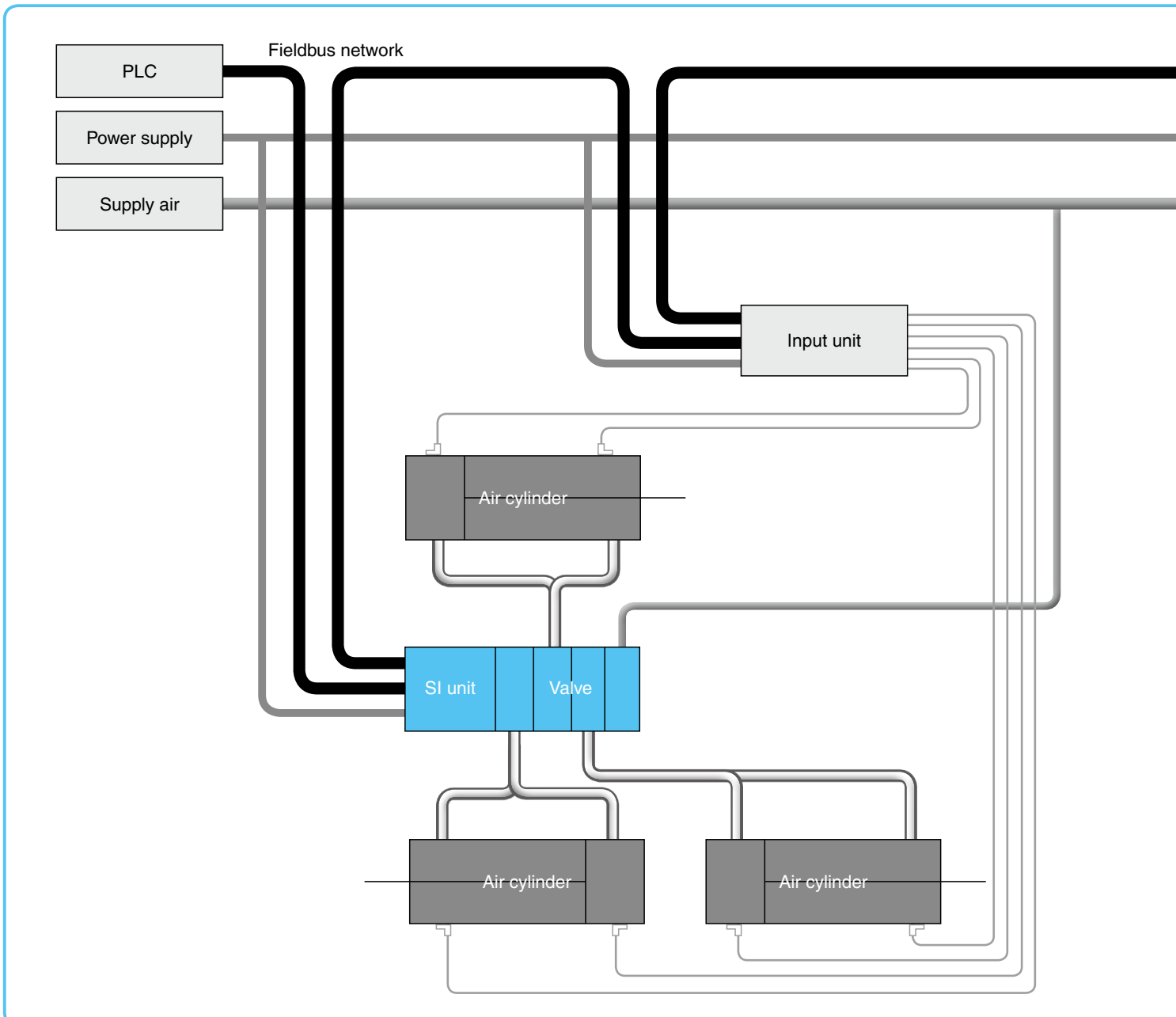

Effectiveness and Compatibility	
Features	It's easy to install into equipment with a small number of I/O points, and it's possible to break up valve manifolds and input units.
Number of nodes	Increases according to the number of valve manifolds and input units
Wiring	Valve manifolds can be installed in the vicinity of an actuator. ➔ Reduced wiring space It is necessary to provide both a communication cable and a power cable.
Piping	Valve manifolds can be installed in the vicinity of an actuator. ➔ Reduced piping space
Actuator responsiveness	Reduced piping space ➔ Increased actuator responsiveness due to shorter piping tubes
Address setting	Address setting is required for each individual SI unit and input unit.
Digital input	Using an input unit not manufactured by SMC
Analog input/output	Using a unit not manufactured by SMC
Change of protocol	All units must be replaced.

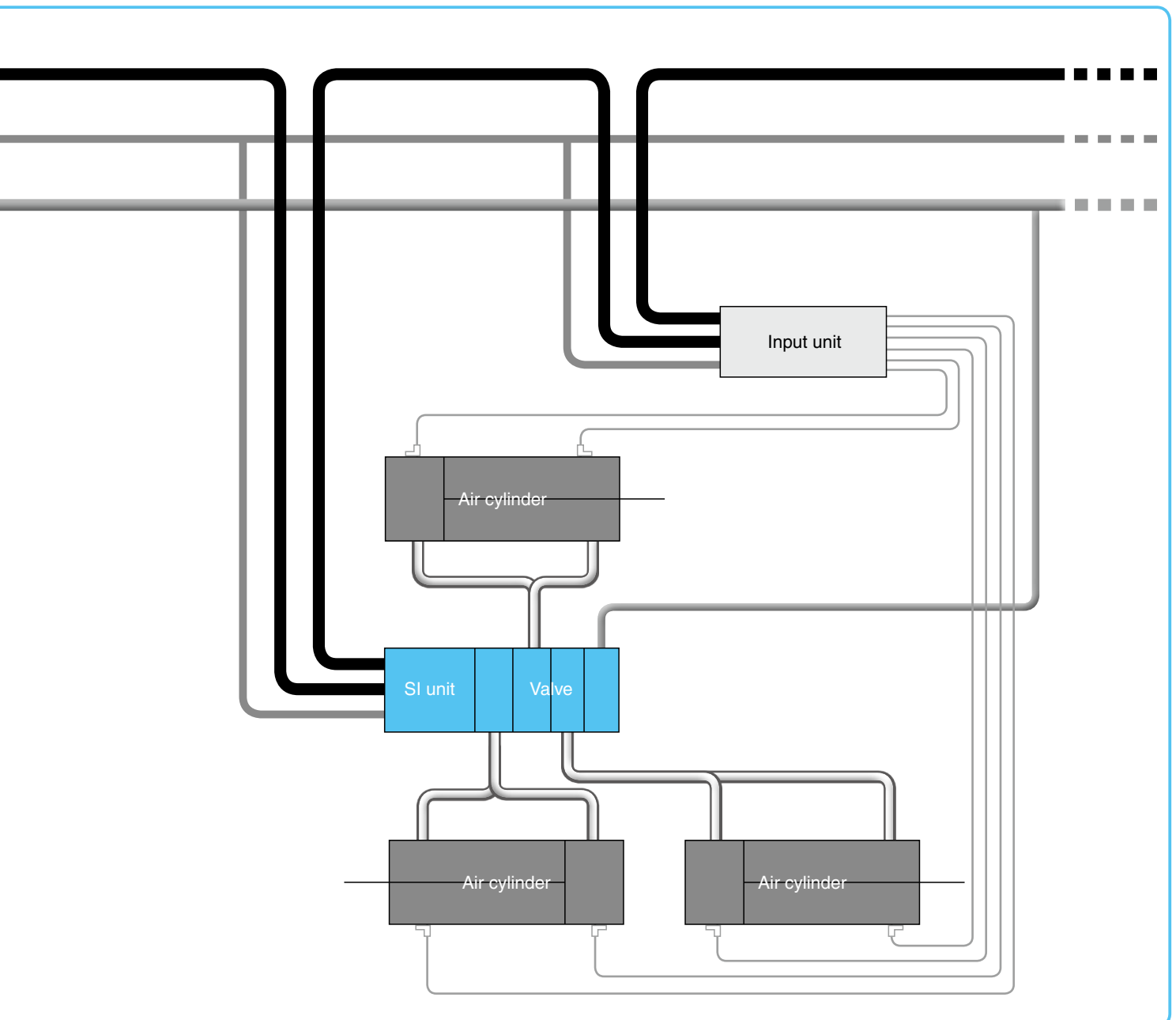

Product Series Featuring 3 Types Suitable to a Variety of Equipment/Facility Layouts

Type 2 Gateway type

- When the use of a GW unit is desired to further reduce the wiring of valve manifolds and input units
- Number of inputs/outputs: Medium (Example: EX500 series [128 outputs])

Applicable products



EX500



EX510

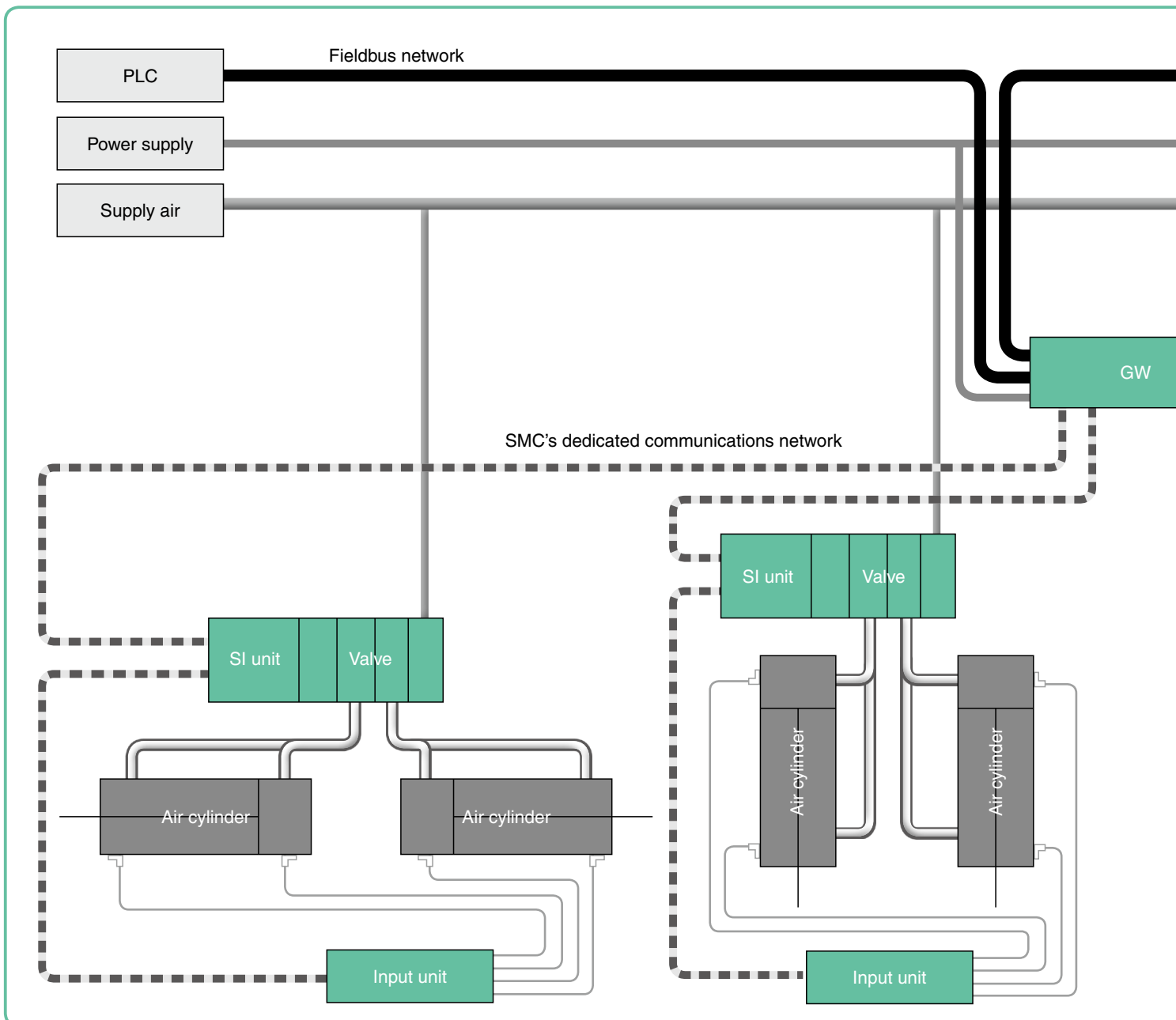



Effectiveness and Compatibility	
Features	It is possible to break up a large number of valve manifolds and input units for installation with the use of a GW unit.
Number of nodes	With 1 node of a GW unit, a large number of valve manifolds and input units can be used. Therefore, it is possible to reduce the number of nodes.
Wiring	Valve manifolds can be installed in the vicinity of an actuator. → Reduced wiring space A single cable can be used in place of a separate power cable and communication cable (for between the GW unit and the valve manifolds/input units).
Piping	Valve manifolds can be installed in the vicinity of an actuator. → Reduced piping space
Actuator responsiveness	Reduced piping space → Increased actuator responsiveness due to shorter piping tubes
Address setting	By conducting the address setting of the GW unit, there is no need to do so for the SI units, input units, etc. This makes plug and play possible.
Digital input	SMC's input units can be used.
Analog input/output	Using a unit not manufactured by SMC
Change of protocol	It is possible to make changes by simply replacing the GW unit.

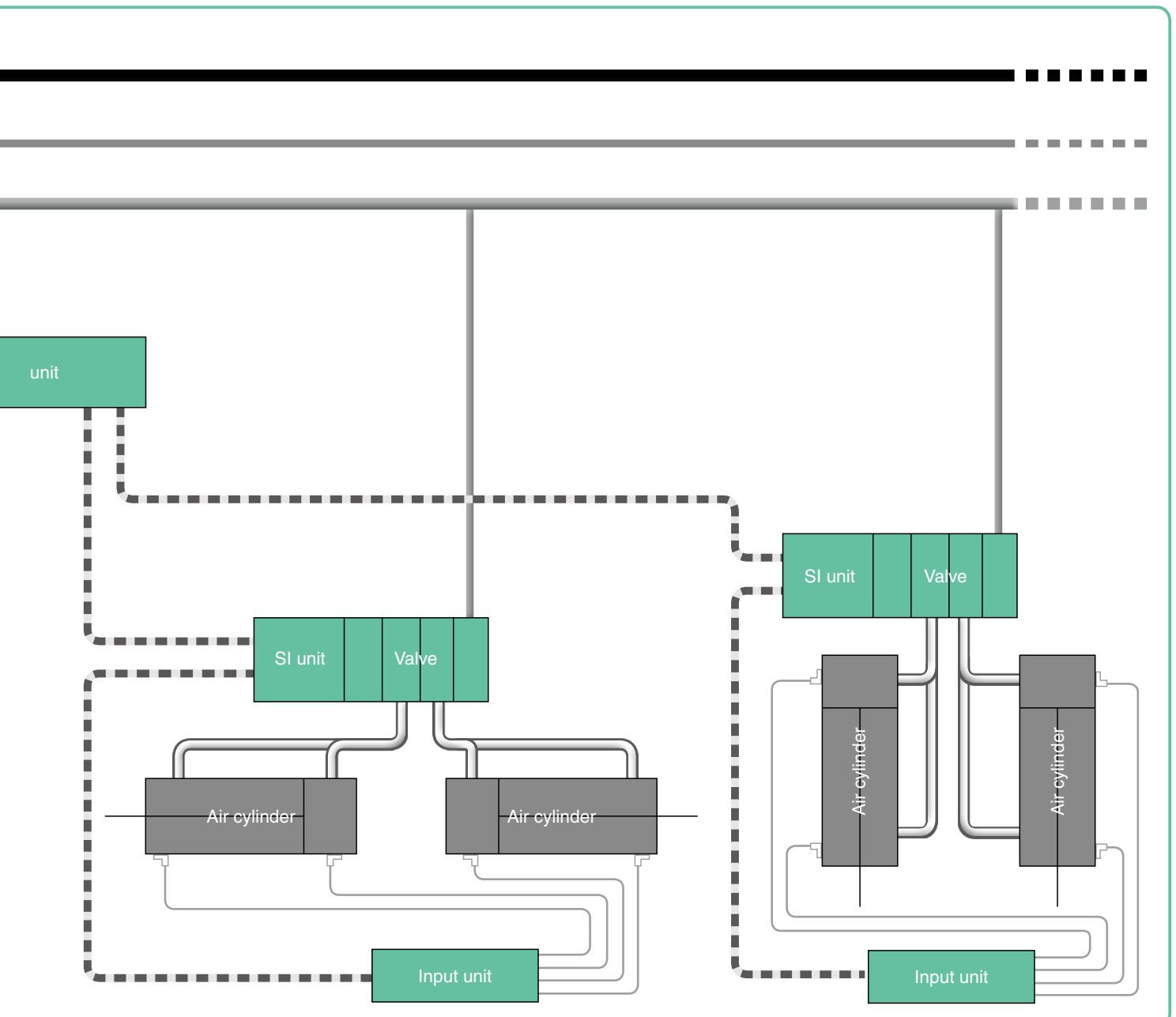

Product Series Featuring 3 Types Suitable to a Variety of Equipment/Facility Layouts

Type 3 Integrated input-output type

- When valve manifolds, input units, etc., are desired to be installed in the same place
- When there is sufficient wiring/piping installation space between the valve manifolds and the actuator
- Number of inputs/outputs: Large (Example: EX600 series [512 outputs])

Applicable products

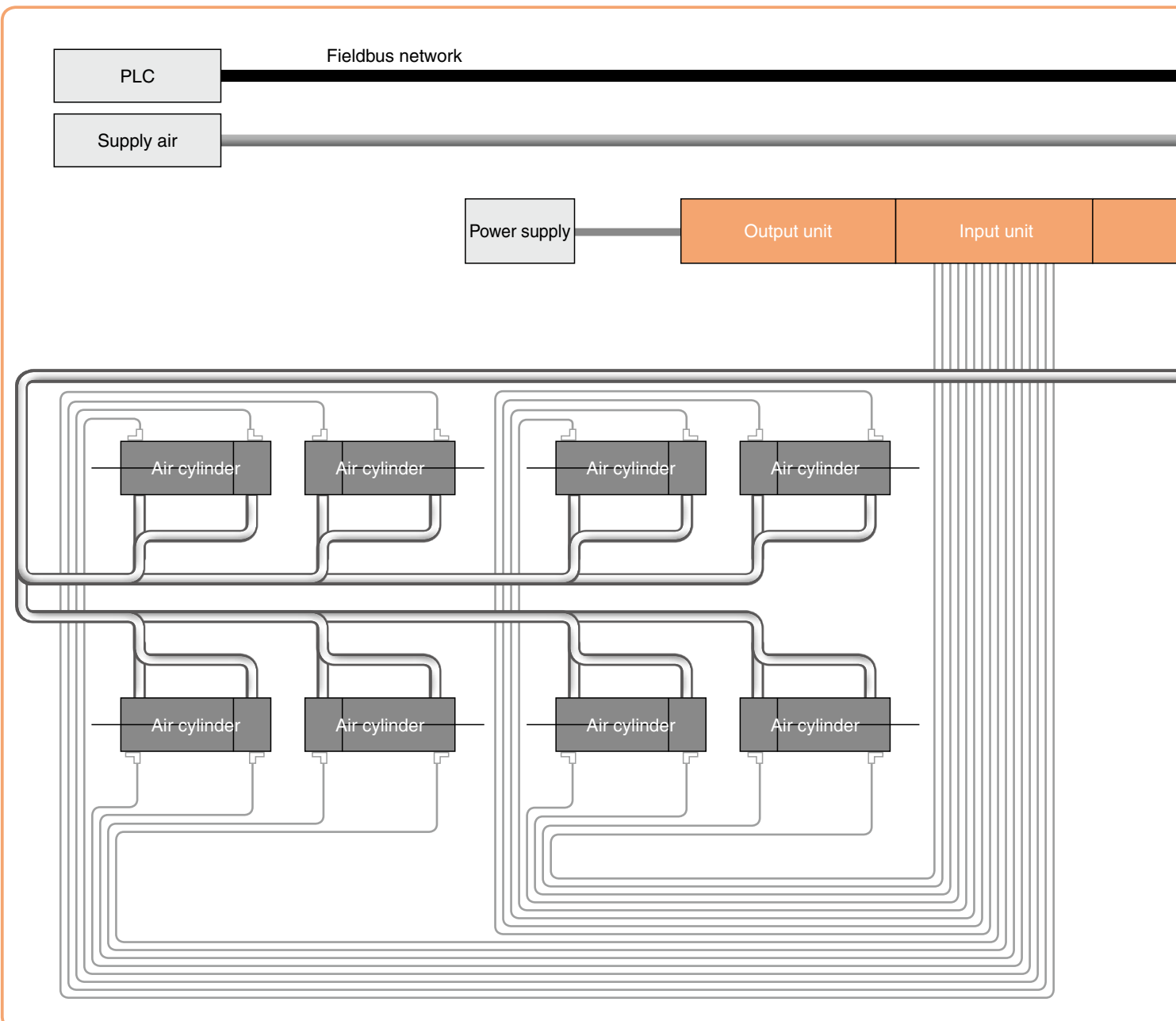

Effectiveness and Compatibility	
Features	Valve manifolds, input units, etc., can be controlled together.
Number of nodes	While the number of nodes is increased according to the number of valve manifolds, the number of nodes can be reduced by linking with an input-output unit.
Wiring	When cables are concentrated in a single area, it's common for the wiring space between the valve manifolds and the actuator to get increasingly complex. It is necessary to provide both a communication cable and power cable.
Piping	When tubes are concentrated in a single area, it's common for the piping space between the valve manifolds and the actuator to get increasingly complex.
Actuator responsiveness	When the piping tubes are too long, it's common for the actuator's responsiveness to decline.
Address setting	Address setting for each individual SI unit is necessary.
Digital input	SMC's input units can be used.
Analog input/output	SMC's units can be used.
Change of protocol	It is possible to make changes by simply replacing the SI unit.

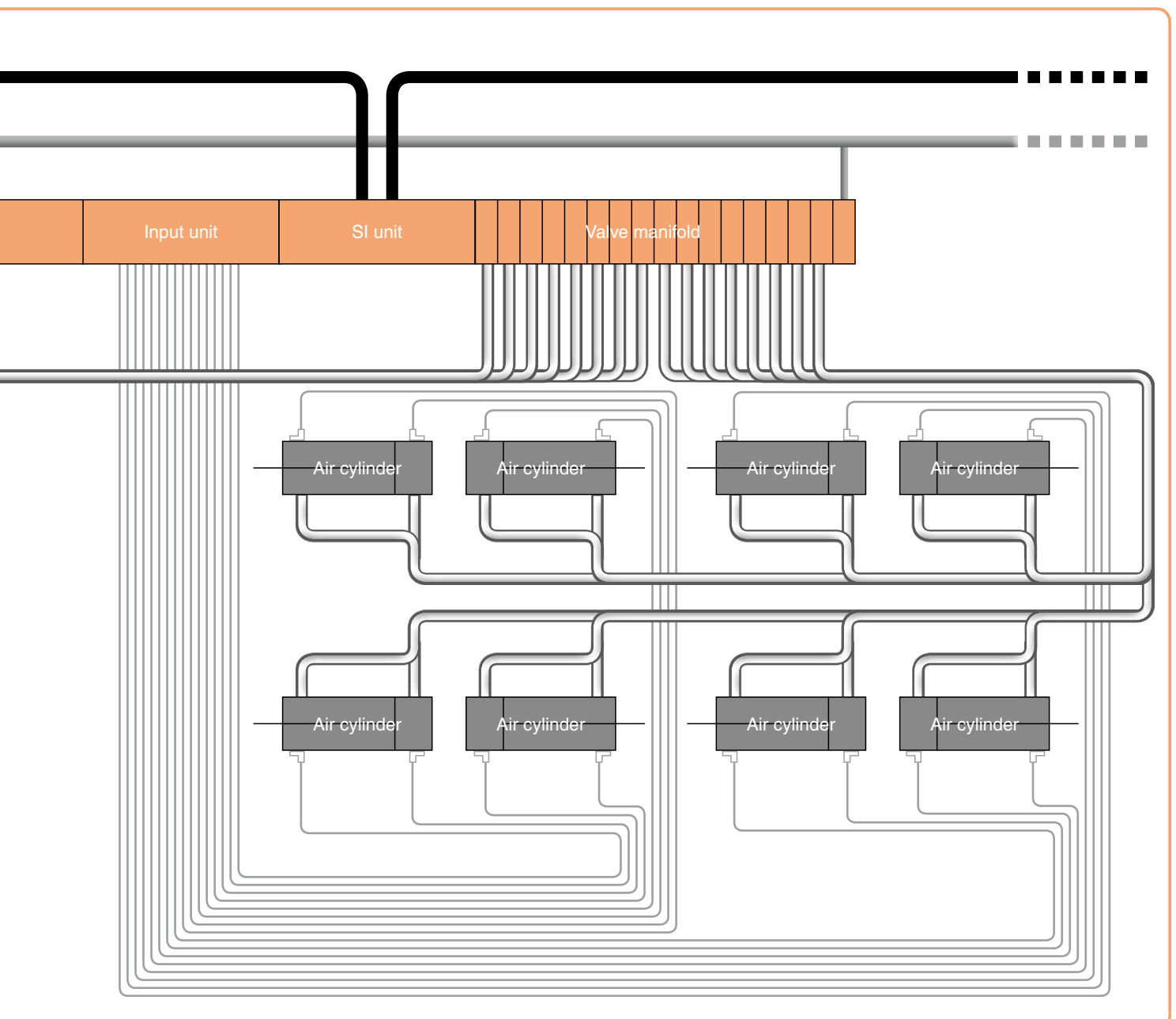

Latest Fieldbus System Technology

Ring type

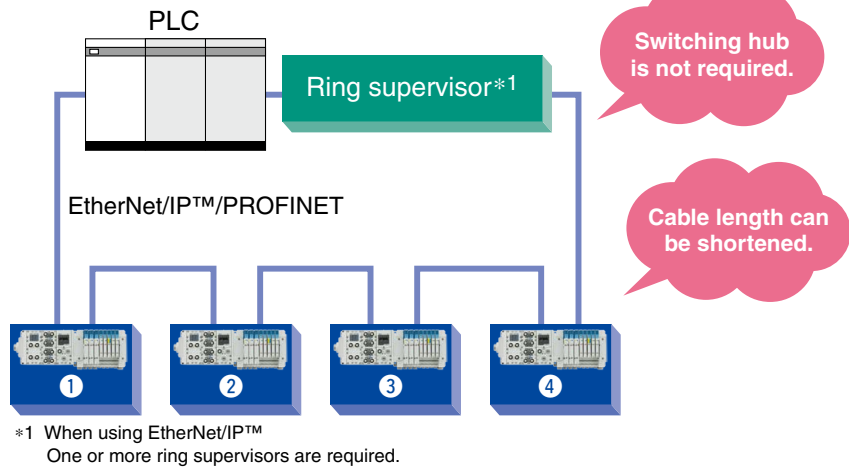

Even if a communication cable is disconnected or damaged at any location, communication can be continued.

- EtherNet/IP™: DLR (Device Level Ring)
- PROFINET: MRP (Media Redundancy Protocol)

With a ring supervisor, the cable segment that is causing the problem can be identified.

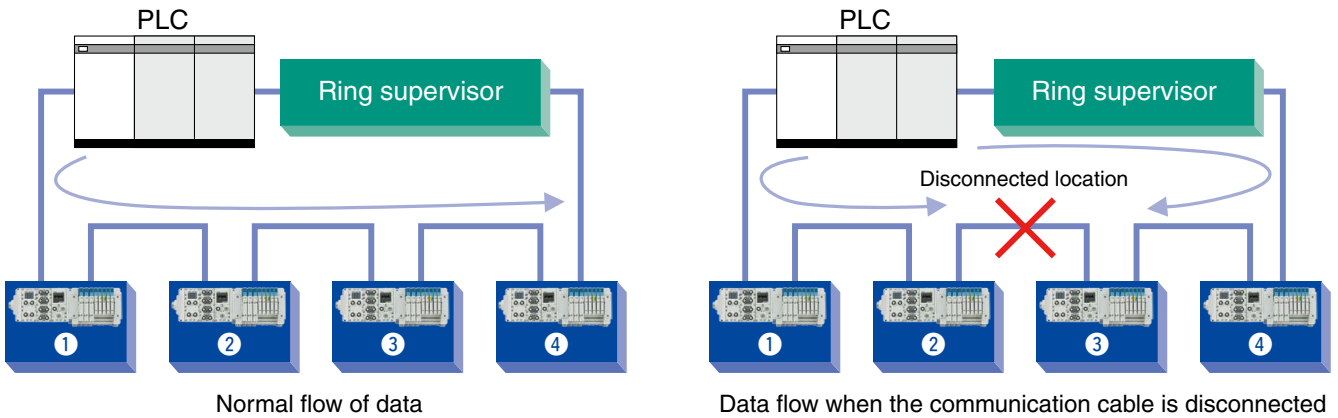

Also applicable for other topologies (connection configuration)

Star type

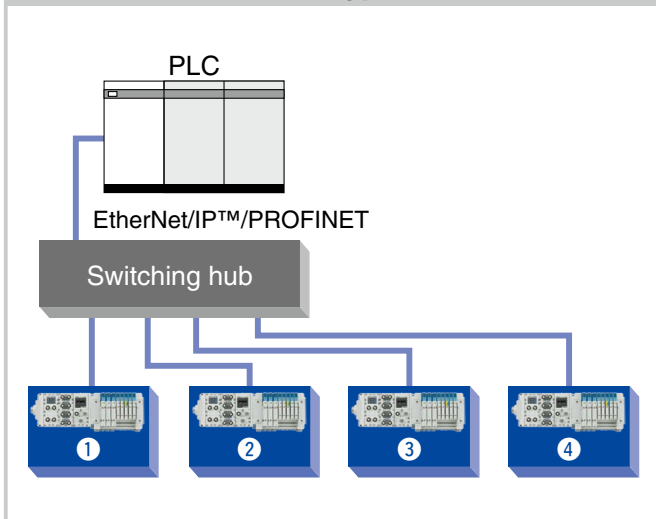

Linear type

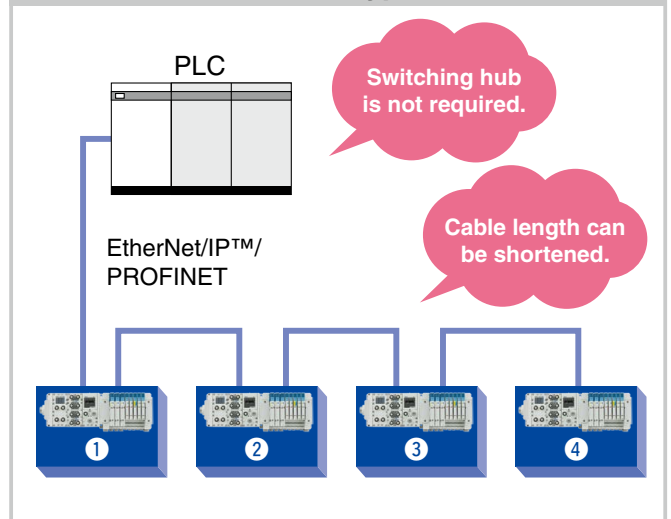

QuickConnect™ function (EtherNet/IP™, DeviceNet™), Fast Start Up function (PROFINET)

For the QuickConnect™ function,
time from power ON to
communication connection

Approx. 10 sec. →

**Approx.
0.5 sec.**

* Times may vary according to
model and system construction.
For details, consult with SMC.

In the case of a tool changer, it takes about 10 seconds for
communication to be connected in some products after the power to
the device installed on the tool is turned ON.

For products which support the QuickConnect™ or the Fast Start Up
function, communication can be operational even faster.

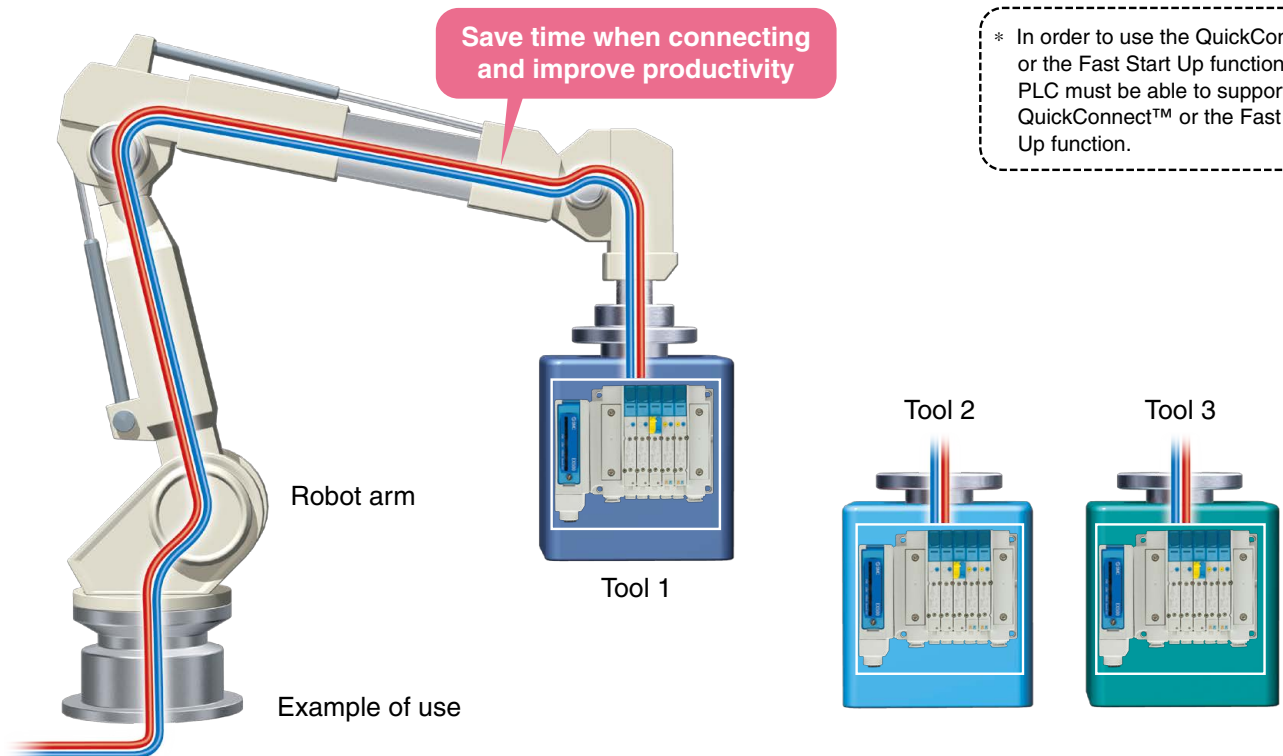

Web server function

Status checks, parameter settings, and forced output are possible with the use of general-purpose web browsers such as Internet Explorer. This allows for efficient system start-up and maintenance.

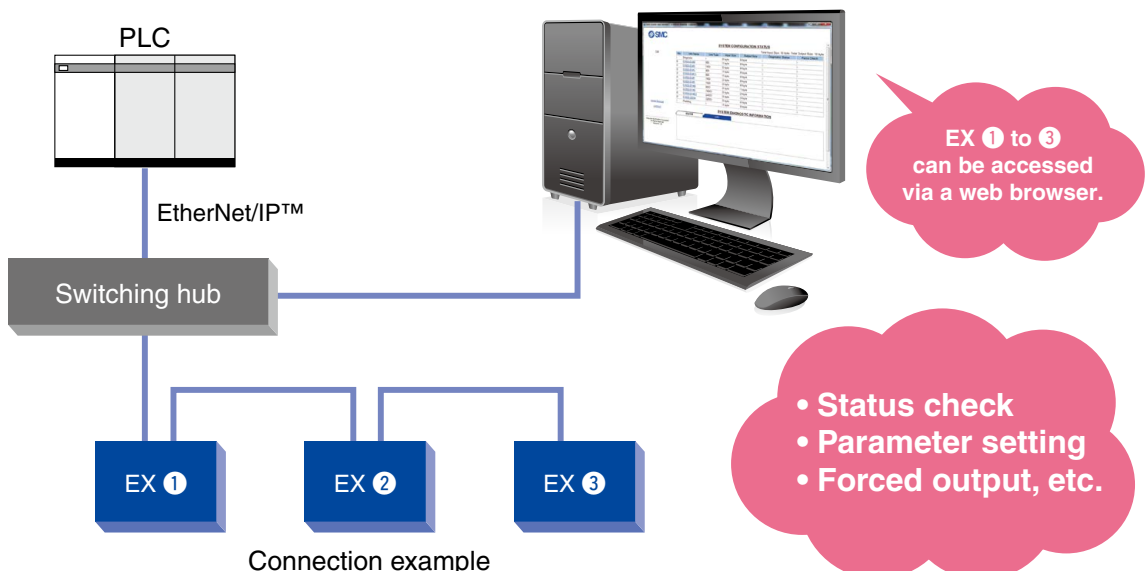

Applicable Product Selection by Type

IP67/65 specification models

		Type 1 Output type for solenoid valves		Type 2 Gateway type	Type 3 Integrated input-output type			
	32	 EX260	 EX123/124/126	 EX500	 EX600	 EX245	 EX245	 EX250
	16							
	16							
	32							
		p. 24	p. 48	p. 54	p. 94	p. 133-1	p. 134	p. 146
Applicable protocols	EtherNet/IP™	●		●	●		●	●
	PROFINET	●		●	●	●	●	●
	Modbus®TCP	◆						◆
	Ethernet POWERLINK	●			◆			
	EtherCAT	●			●			
	CC-Link IE Field				◆			◆
	PROFIBUS DP	●		●	●			●
	DeviceNet™		●	●				●
	CC-Link	●	●		●			
	AS-Interface	◆						●
	CANopen							●
	CompoNet™		◆					
	INTERBUS						◆	
IO-Link	●*2							
Series		EX260	EX123/124/126	EX500	EX600	EX245	EX245	EX250
Applicable valve series	JSY (Plug-in connector connecting base: 10 type)	1000	●		●			●
		3000	●			●		●
		5000	●			●	●	●
	SY (Plug-in connector connecting base: 10/11/12 type)	3000	●	●	●	●	●	●
		5000	●	●	●	●	●	●
		7000	●	●	●	●	◆	●
	S0700 (Stacking base)	0700	●	●	●	●	◆	●
	SV	1000	●	●	●	●	◆	●
		2000	●	●	●	●	◆	●
		3000	●	●	●	●	◆	●
		4000	●	●	●	●	◆	●
	VQC	1000	●	●	●	●	◆	●
		2000	●	●	●	●	◆	●
4000		●	●	●	●	◆	●	
5000		●	●	●	●	◆	●	
VQ	1000	●	●	●	●	◆	●	
	2000	●	●	●	●	◆	●	
	4000	●	●	●	●	◆	●	
	5000	●	●	●	●	◆	●	

●: Standard product ◆: Made to order

*1 For details, refer to the catalog of each product.
 *2 There is no product number setting for the S0700, SV series manifold for the EX260 IO-Link compatible type.

IP20 specification models

			Type 1 Output type for solenoid valves				Type 2 Gateway type	Type 3 Integrated input-output type			
	Number of valve outputs	32									
		16									
		16									
	Number of inputs	32	p. 172	p. 172	p. 180	p. 184	p. 189				
Applicable protocols	EtherNet/IP™						◆				
	PROFINET						◆				
	Modbus®TCP										
	Ethernet POWERLINK										
	EtherCAT					◆					
	CC-Link IE Field										
	PROFIBUS DP						●				
	DeviceNet™		●	●	●	●	●				
	CC-Link		●	●	●	●	●				
	AS-Interface										
	CANopen										
CompoNet™		●	●								
INTERBUS											
IO-Link											
Series			EX120	EX121	EX122	EX140	EX180	EX510	—		
Applicable valve series	JSY	(Plug-in connector connecting base: 10 type)	●								
		3000	●								
		5000	●								
	SY	(Plug-in connector connecting base: 10/11/12 type)	3000	●		●					
			5000	●		●					
			7000	●		●					
		(Plug-in metal base: 50/51/52 type)	3000						●		
			5000						●		
			7000						●		
	SJ	2000					●				
		3000					●				
	S0700 (Bar stock)		0700				●				
	SY	(Bar stock: 42SA type)	3000						●		
			5000						●		
			7000						●		
		(Stacking base: 45S6/43SA type)	3000	●		●				●	
			5000	●		●				●	
			7000	●		●				●	
	SV	1000	●		●						
		2000	●		●						
		3000	●		●						
		4000	●		●						
	VQ	1000	●		●				●		
		2000	●		●				●		
4000		●		●				●			
SQ	1000				●			●			
	2000				●			●			
	3000				●			●			
VQZ	1000							●			
	2000							●			
	3000							●			
SYJ	3000							●			
	5000							●			
	7000							●			

●: Standard product ◆: Made to order

*1 For details, refer to the catalog of each product.

Applicable Valve Series ①

JSY1000/3000/5000 Series

● Plug-in Type

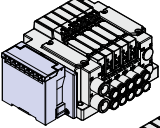
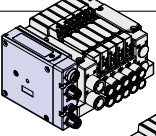
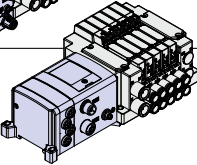
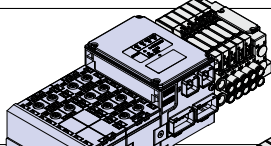
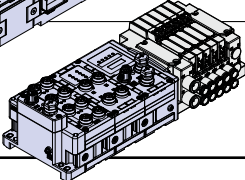
SI unit		Valve series		How to Order valves
	EX120 ▶ p. 178	JSY1000/3000/5000	Connector connecting base Side ported	Refer to the Web Catalog .
	EX260 ▶ p. 24		Connector connecting base Side ported	
	EX250 ▶ p. 152		Connector connecting base Side ported	
	EX245 ▶ p. 133-1	JSY3000/5000	Connector connecting base Side ported	
	EX600 ▶ p. 94	JSY1000/3000/5000	Connector connecting base Side ported	

SY3000/5000/7000 Series

● Plug-in Type

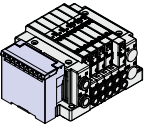
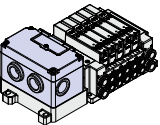
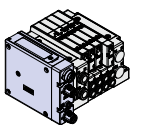
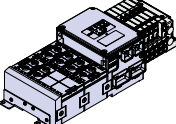
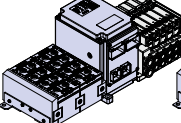
SI unit		Valve series		How to Order valves
	EX120 ▶ p. 178	SY3000/5000/7000	Connector connecting base Side ported/Bottom ported/ Top ported	Refer to the Web Catalog or Best Pneumatics No. 1-1.
	EX126 ▶ p. 48		Connector connecting base Side ported/Bottom ported/ Top ported	
	EX260 ▶ p. 24		Connector connecting base Side ported/Bottom ported/ Top ported	
	EX245 ▶ p. 133-1	SY3000/5000	Connector connecting base Side ported/Bottom ported/ Top ported	
	EX245 ▶ p. 134	SY3000/5000/7000	Connector connecting base Side ported/Bottom ported/ Top ported	

Applicable Valve Series ②

SY3000/5000/7000/9000 Series

● Plug-in Type

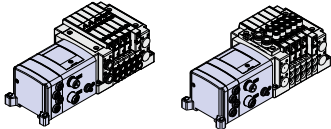
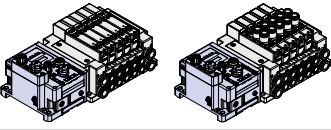
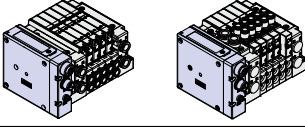
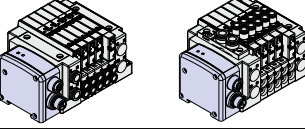
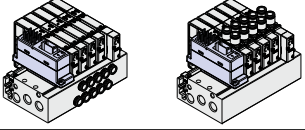
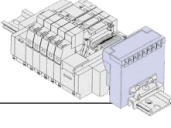
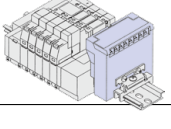
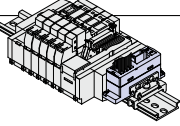
SI unit		Valve series		How to Order valves
	EX250 ▶ p. 152	SY3000/5000/7000	Connector connecting base Side ported/Bottom ported/ Top ported	Refer to the Web Catalog or Best Pneumatics No. 1-1.
	EX600 ▶ p. 94		Connector connecting base Side ported/Bottom ported/ Top ported	
	Gateway Decentralized System 2 (128 Points) EX500 ▶ p. 54		Connector connecting base Side ported/Bottom ported/ Top ported	
	Gateway Decentralized System (64 Points) EX500 ▶ p. 54		Connector connecting base Side ported/Bottom ported/ Top ported	
	EX510 ▶ p. 195		Metal base Side ported/Bottom ported/ Top ported	
	EX121 ▶ p. 178		SY3000/5000	
	EX122 ▶ p. 178	Base mounted Stacking type SI unit integrated type		
	EX510 ▶ p. 195	Base mounted Stacking type		

● Non Plug-in Type (Plug Lead Type)

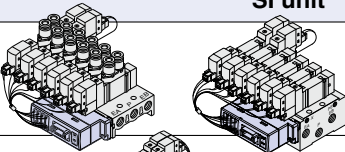
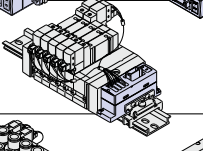
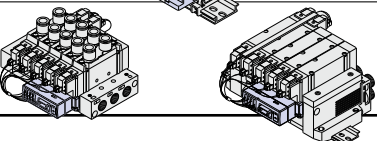
SI unit		Valve series		How to Order valves
	EX510 ▶ p. 189	SY3000/5000/7000	Body ported/Base mounted Bar stock type	Refer to the Web Catalog or Best Pneumatics No. 1-1.
		SY3000/5000	Base mounted Stacking type	
		SY9000	Body ported/Base mounted Stacking type	

Applicable Valve Series ③

SJ2000/3000 Series

● Plug-in Type

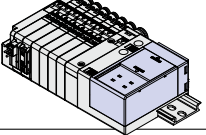
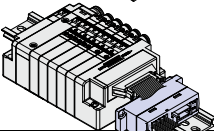
SI unit		Valve series		How to Order valves
	EX180 ▶ p. 190	SJ2000/3000	Connector connecting cassette type manifold	Refer to the Web Catalog or Best Pneumatics No. 1-1.
	EX510 ▶ p. 195			

S0700 Series

● Plug-in Type

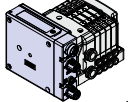
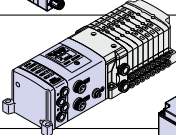
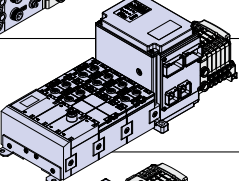
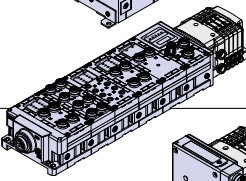
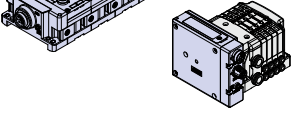
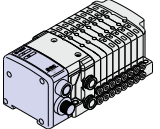
SI unit		Valve series		How to Order valves	
	EX260 ▶ p. 24	S0700	Base mounted	Refer to the Web Catalog or Best Pneumatics No. 1-1.	
	EX250 ▶ p. 146				
	EX245 ▶ p. 134			Refer to the Web Catalog .	
	EX600 ▶ p. 94				
	Gateway Decentralized System 2 (128 Points) EX500 ▶ p. 54				Refer to the Web Catalog or Best Pneumatics No. 1-1.
	Gateway Decentralized System (64 Points) EX500 ▶ p. 54				

Applicable Valve Series 4

S0700 Series

• Non Plug-in Type (Plug Lead Type)

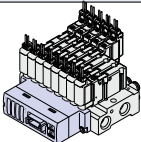
SI unit		Valve series		How to Order valves
	EX510 ▶ p. 189	S0700	Base mounted	Refer to the Web Catalog or Best Pneumatics No. 1-1.

• Slim Compact (Plug-in Type)

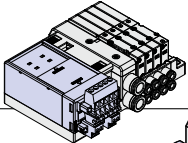
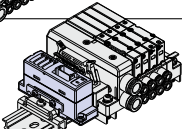
SI unit		Valve series		How to Order valves
	EX180 ▶ p. 184	S0700	Base mounted	Refer to the Web Catalog or Best Pneumatics No. 1-1.
	EX510 ▶ p. 189			

SV1000/2000/3000/4000 Series

• Plug-in Type

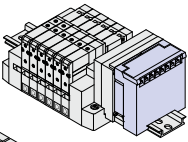
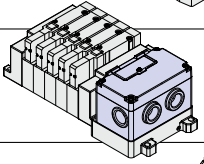
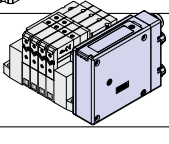
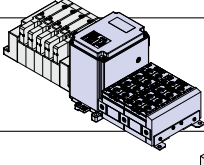
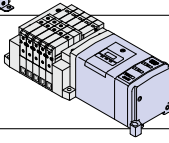
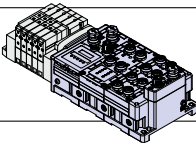
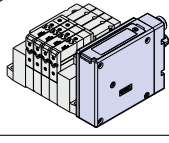
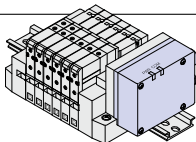
SI unit		Valve series		How to Order valves
	EX120 ▶ p. 172	SV1000/2000	Connector type manifold Cassette base	Refer to the Web Catalog or Best Pneumatics No. 1-2.
	EX126 ▶ p. 48	SV1000/2000/ 3000/4000	Connector type manifold Tie-rod base	
	EX260 ▶ p. 24	SV1000/2000/3000	Connector type manifold Tie-rod base	Refer to the Web Catalog .
	EX245 ▶ p. 134			
	EX250 ▶ p. 146			
	EX600 ▶ p. 94			
	Gateway Decentralized System 2 (128 Points) EX500 ▶ p. 54	SV1000/2000	Connector type manifold Cassette base	Refer to the Web Catalog or Best Pneumatics No. 1-2.
	Gateway Decentralized System (64 Points) EX500 ▶ p. 54		SV1000/2000/ 3000/4000	

Applicable Valve Series 5

SYJ3000/5000/7000 Series

• Non Plug-in Type (Plug Lead Type)

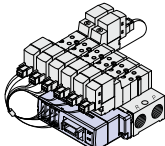
SI unit	Valve series		How to Order valves
	EX510 ▶ p. 189	SYJ3000/5000/7000	Body ported
			Base mounted
			Refer to the Web Catalog or Best Pneumatics No. 1-2.

SZ Series

• Plug-in Type

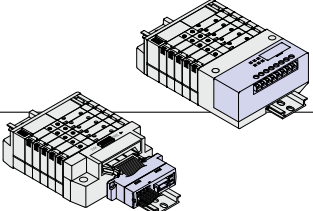
SI unit	Valve series		How to Order valves
	EX140 ▶ p. 180 EX510 ▶ p. 189	SZ3000	Cassette type manifold
			Refer to the Web Catalog or Best Pneumatics No. 1-2.

VQ Series

• Plug-in Type

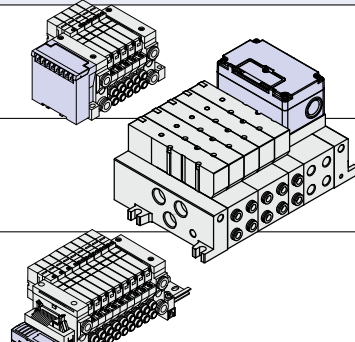
SI unit	Valve series		How to Order valves
	EX120 ▶ p. 172 EX123 EX124 ▶ p. 48	VQ1000/2000	Base mounted
		VQ2000/4000/5000	Base mounted IP65-compliant
	EX510 ▶ p. 189	VQ1000/2000	Base mounted
			Refer to the Web Catalog or Best Pneumatics No. 1-2.

Applicable Valve Series 6

VQC Series

• Plug-in Type

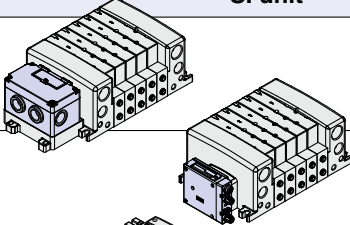
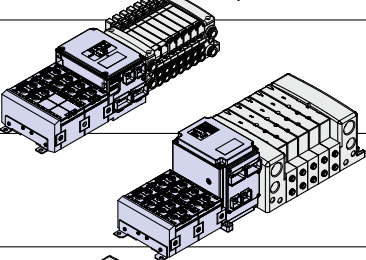
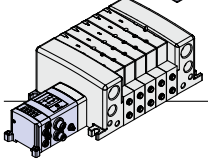
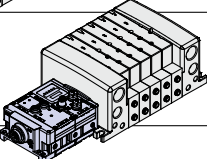
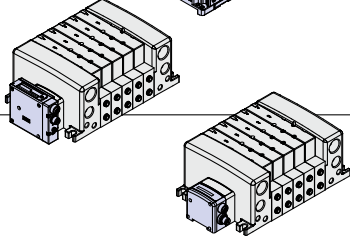
SI unit		Valve series		How to Order valves
	EX126 ▶ p. 48	VQC1000/2000/ 4000/5000		Best Pneumatics No. 1-2
	EX260 ▶ p. 24			
	EX245 ▶ p. 133-1	VQC2000/4000		Refer to the Web Catalog.
	EX245 ▶ p. 134			
	EX250 ▶ p. 146	VQC1000/2000/ 4000/5000	Base mounted	Best Pneumatics No. 1-2
	EX600 ▶ p. 94			
	Gateway Decentralized System 2 (128 Points) EX500 ▶ p. 54			
	Gateway Decentralized System (64 Points) EX500 ▶ p. 54			

VQZ Series

• Non Plug-in Type (Plug Lead Type)

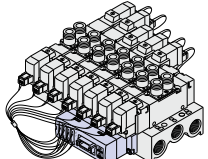
SI unit		Valve series		How to Order valves
	EX510 ▶ p. 189	VQZ1000/2000/ 3000	Body ported	Refer to the Web Catalog or Best Pneumatics No. 1-2.
			Base mounted	

SQ Series

• Plug-in Type

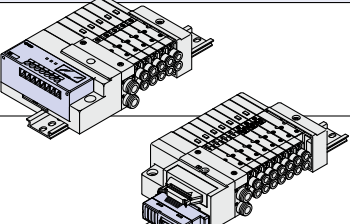
SI unit		Valve series		How to Order valves
	EX140 ▶ p. 180	SQ1000/2000	Body ported	Best Pneumatics No. 1-2
	EX510 ▶ p. 189			