

# Ionizer

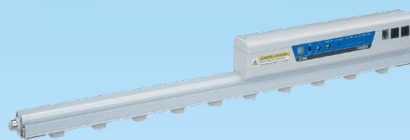

Potential amplitude: **25 V** or less<sup>\*1</sup>

Rapid static neutralization: Fastest time **0.1 s**<sup>\*2</sup>



## Dual AC Type *IZS42 Series*

The potential amplitude of the workpiece is reduced by means of dual AC.



## Feedback Sensor Type *IZS41 Series*

Rapid static neutralization by a feedback sensor

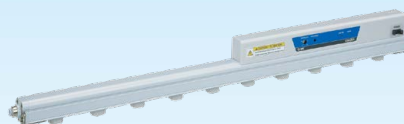

## Standard Type *IZS40 Series*

Simple operation: Can be controlled by powering the ionizer ON

\*1 IZS42 installation height: 300 mm

\*2 Conditions: With feedback sensor, Discharge time from 1000 V to 100 V  
Object to be neutralized: Charged plate (150 mm x 150 mm, Capacitance 20 pF)  
Installation distance: 200 mm (Tungsten emitter with air purge)

# IZS40/41/42 Series



CAT.ES100-97C

## Dual AC Type IZS42 Series (Potential amplitude reduction specification)

**Potential amplitude: 25 V or less 80% reduction compared to the existing model**  
 (Compared to the IZS31 series at an installation height of 300 mm)

The potential amplitude can be reduced with **SMC's original dual AC type sensor**.

Static neutralization in consideration of damage to a device which is sensitive to electrostatic discharge (ESD) can be achieved.

The potential amplitude generated in the applicable workpiece is reduced even if the workpiece is mounted within close proximity of the ionizer.

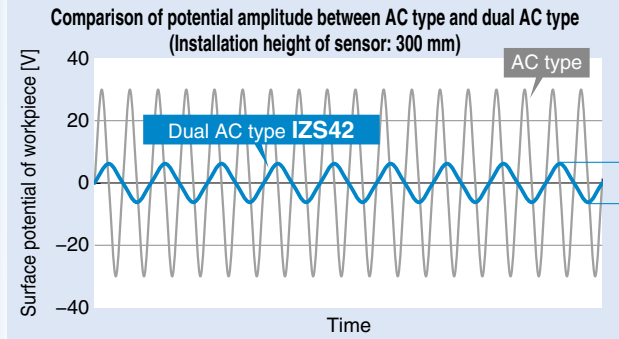

### Implementation of our original dual AC type

#### Dual AC type IZS42

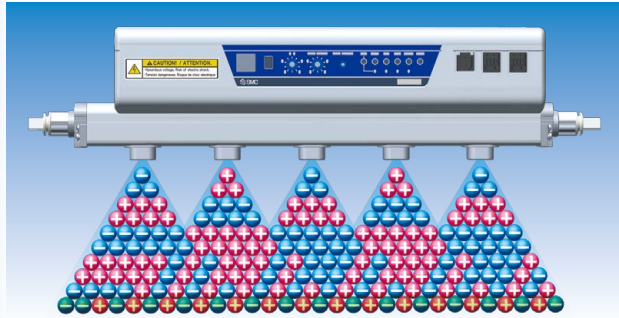

+ ions and - ions are discharged at the same time to allow the + and - ions to reach the workpiece evenly, thereby reducing the potential amplitude.

#### For the static neutralization of glass substrates

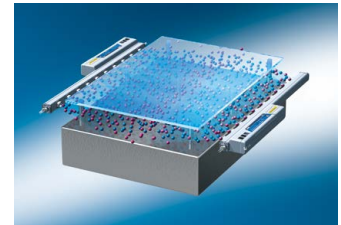

Prevents the breakage of glass substrates by the static electricity generated when the substrate is lifted from the surface plate

#### AC type

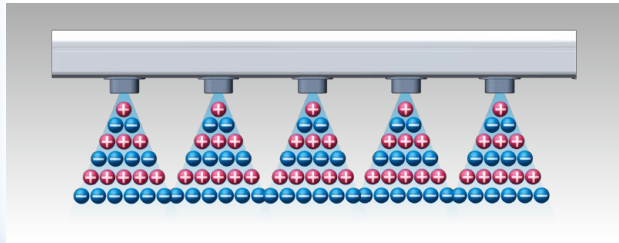

+ ion and - ion layers reach the workpiece alternately, which increases the potential amplitude.

#### For the static neutralization of electric substrates

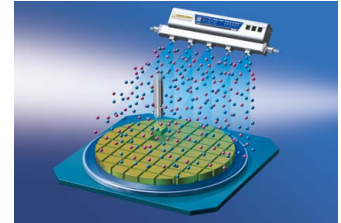

Prevents the breakage of electric substrates by the static electricity generated when the substrates are picked up after dicing

## Standard Type IZS40 Series

**Simple operation: Can be controlled by powering the ionizer ON**

**Discharge time = 3.2 seconds (41% faster)**  
**when installed at a long distance (1000 mm)**



Static neutralization data when the voltage is reduced from 1000 V to 100 V  
 <Conditions> Ion generation frequency: 30 Hz, Supply pressure: 0.1 MPa, High speed static neutralization cartridge

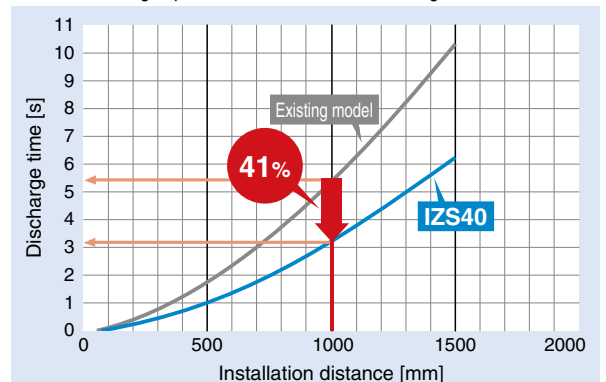

# Feedback Sensor Type IZS41 Series (High speed static neutralization specification)

## Rapid static neutralization by a feedback sensor \* An auto balance sensor is installed.

The discharge speed can be increased by using a feedback sensor (option) to detect the workpiece's electrostatic potential and continuously emit ions of the opposite polarity.

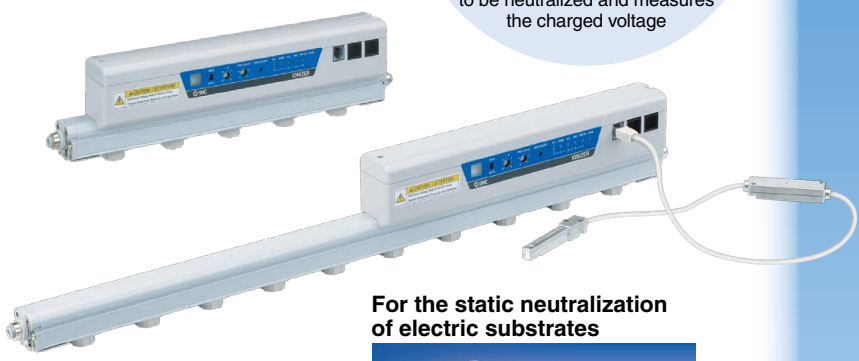
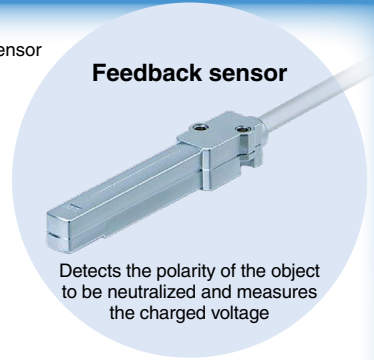
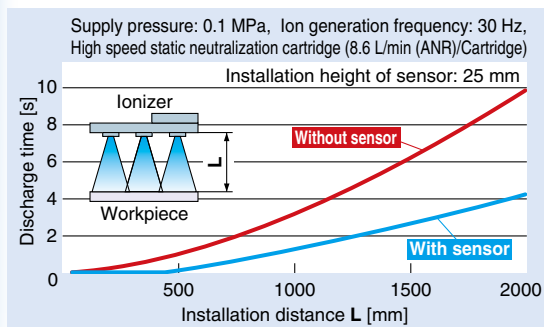
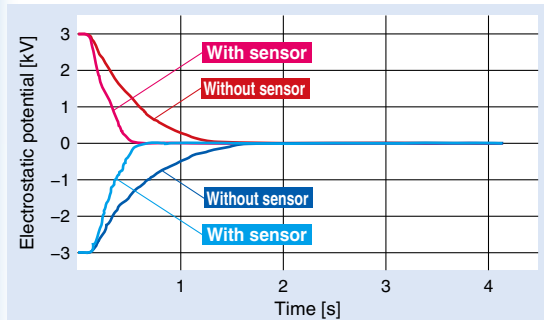

**For the static neutralization of electric substrates**

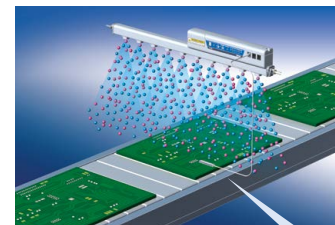

- Prevents element disruption due to discharge
- Prevents the adhesion of dust

**For the static neutralization of glass substrates**

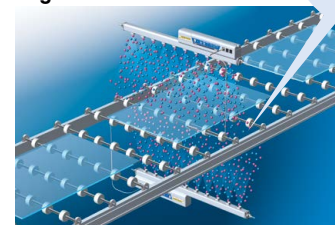

- Prevents breakage due to adhesion and discharge
- Prevents the adhesion of dust

The operating mode after static neutralization (when electrostatic potential: within  $\pm 30$  V) can be selected.

- **Energy saving mode** Stops generating ions after static neutralization to reduce power consumption
- **Continuous static neutralization mode** After static neutralization, the ionizer continues to neutralize static electricity in AC mode while maintaining the electrostatic potential within  $\pm 30$  V.

**Continuous static neutralization mode**

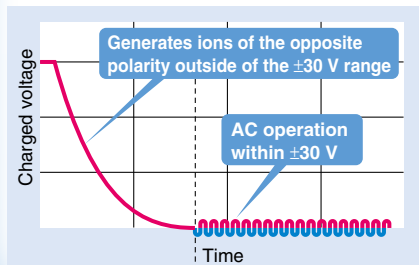

Operating mode		Ion emission waveform	
Sensing AC	Energy saving mode	+	Stop
	Continuous static neutralization mode	+	[Pulsed waveform]
AC (Without sensor)		+	[Continuous AC waveform]
Workpiece electrification		+	[Continuous AC waveform]

- An AC adapter power supply is available.



An e-con connector is used.



Suitable for the static neutralization of resin and rubber pieces (small parts)

**For the static neutralization of PET bottles**

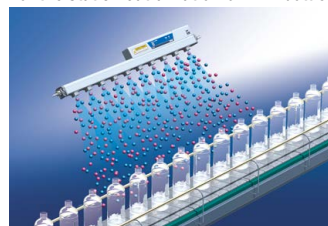

- Prevents bottles from falling over on conveyor belts
- Prevents the adhesion of dust

**For the static neutralization of molded goods**

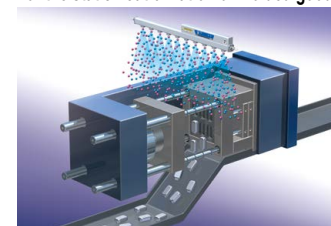

- Improves the detachability of molded goods from the mold



Adjustment and maintenance labor can be reduced by using an auto balance sensor.



## Built-in type (Standard)

The sensor is installed within the ionizer body and may be mounted anywhere.

The offset voltage (ion balance) in the static neutralization area is controlled so that the voltage is maintained at a constant value. This is achieved by monitoring the ions emitted from the ionizer using the ground line and adjusting the + and - ion supply rates.

### Effect of auto balance sensor (Image)

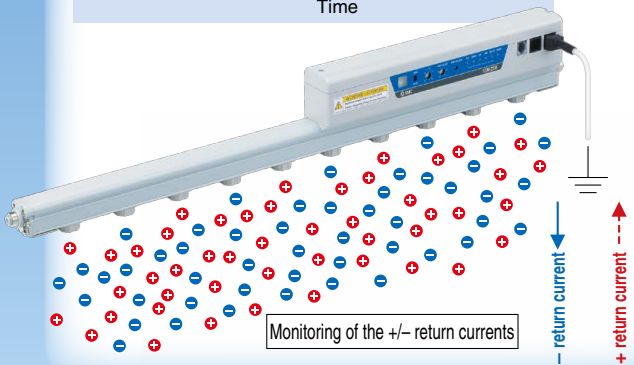
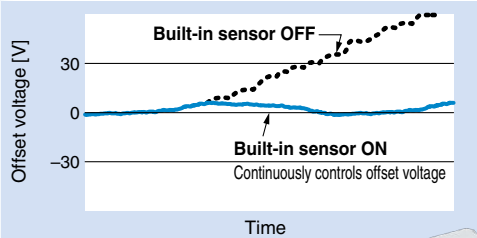

## High accuracy type (Option)

- The ion balance near the workpiece can be accurately adjusted automatically.
- Reduces fluctuations in the offset voltage of the static neutralization area caused by the installation height, disturbances, etc.

### Auto balance sensor

Measures the nearest offset voltage

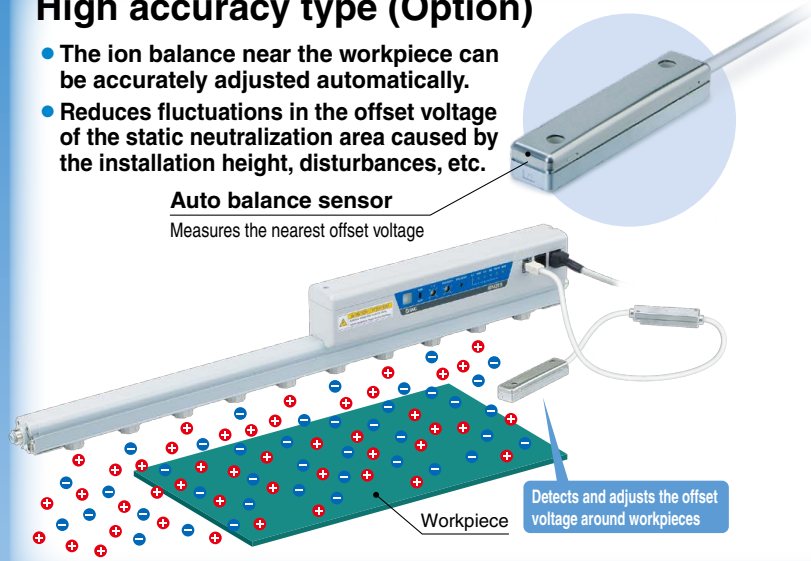

Various low maintenance cartridges can be selected according to the application.



### • 3 types of emitter cartridges

#### High speed static neutralization cartridge

1 cartridge equipped with 2 assist air nozzles allows for high speed static neutralization by transferring ionized air produced in the emitter to the workpiece.

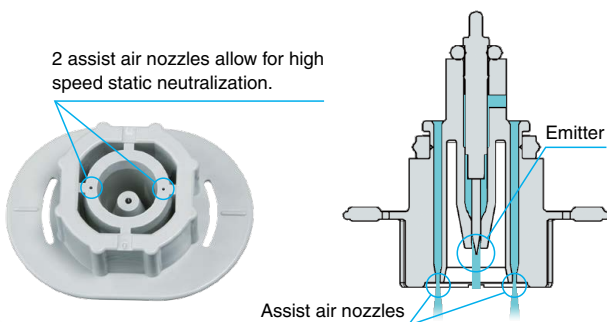

#### Energy saving static neutralization cartridge

Reducing the number of assist nozzles by half for static neutralization, which does not require a high volume of assist air due to the close distance to the object to be neutralized, allows for energy savings by reducing air consumption.

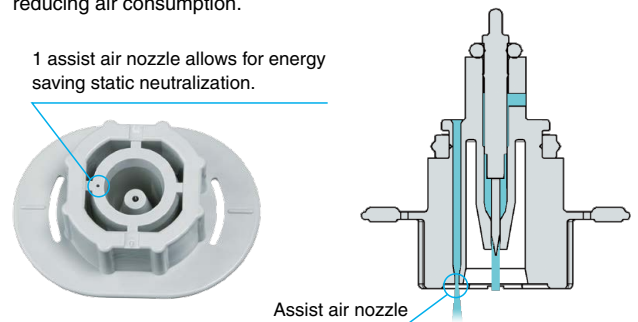



- Select from "Manual Operation" mode, which performs adjustment only when connected, and "Automatic Operation" mode, which continuously performs adjustment while connected.

Effect of auto balance sensor (Image)

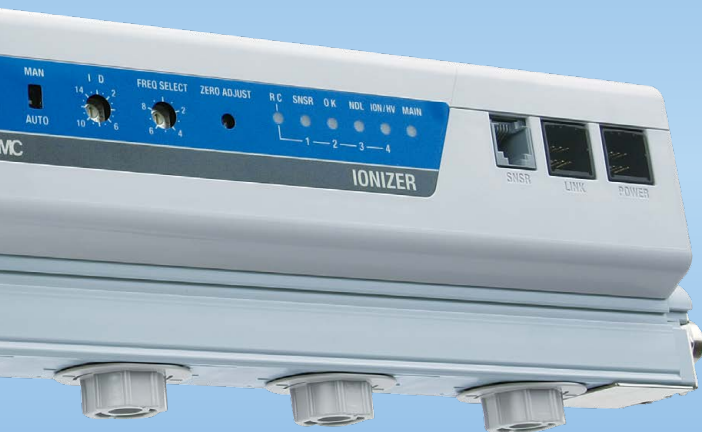
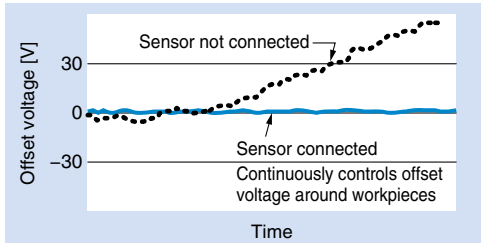

- Minimizes the contamination of emitters by discharging compressed air at the surface of the emitters

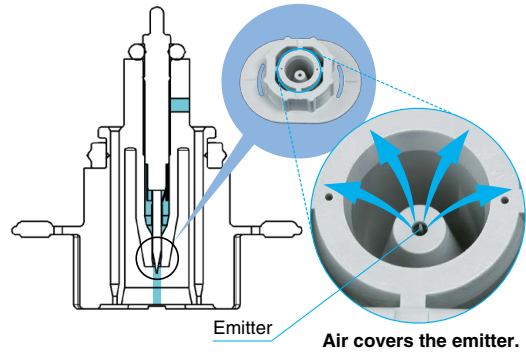

- 2 types of emitter materials

Tungsten/Single crystal silicon (for silicon wafers)



Tungsten  
(Emitter cartridge color: White)



Single crystal silicon  
(Emitter cartridge color: Gray)

Energy saving high-efficiency cartridge

Assist air amplified by the sucking in of ambient air (the ejector effect) allows for highly efficient static neutralization through the efficient transfer of the produced ionized air.

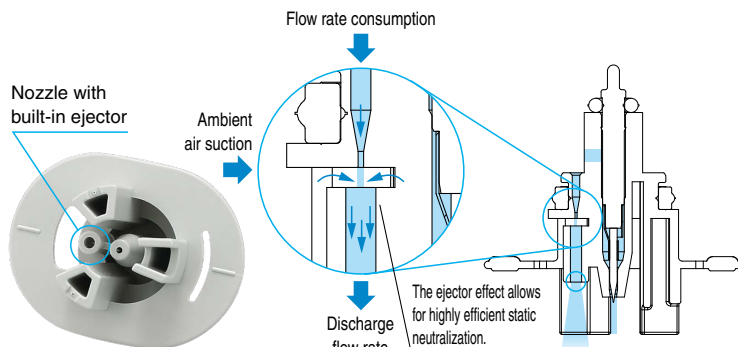

Flow rate for installation distance of each cartridge

Conditions: IZS41-1120□ (Number of cartridges: 18 pcs.), Discharge time 1 s

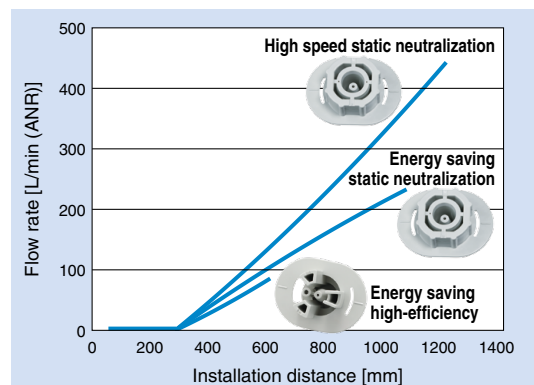

## Air can be supplied by air piping on one side.

- The optimal design of the piping port size allows for sufficient blow performance even with piping only on one side.

Piping on both sides  
 Piping only on one side

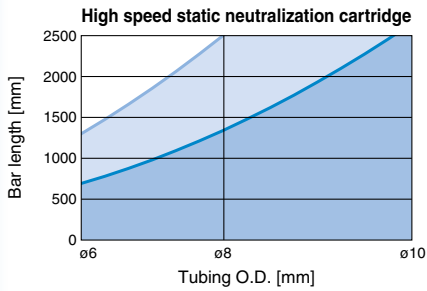

2 assist air nozzles allow for high speed static neutralization.

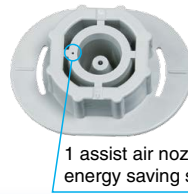
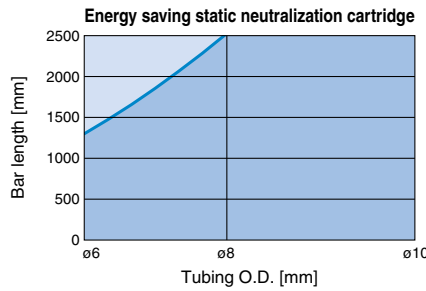

1 assist air nozzle allows for energy saving static neutralization.

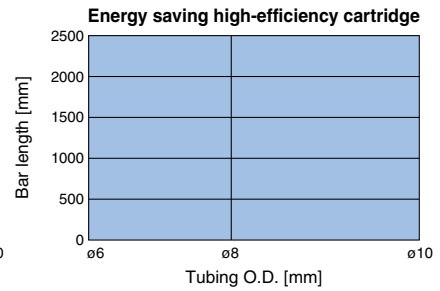

Nozzle with built-in ejector

## Air supply port position is selectable: Right side/Left side/Both sides

\* Use a plug if the product is used with piping only on one side.



## The bar length is selectable. pp. 15, 16

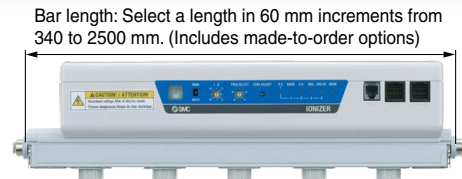

## The ionizers can be set with a remote controller. IZS 41 IZS 42

- Can be used to adjust and set several ionizers remotely
- Can recognize and control up to 16 ionizers through address setting
- Frequency setting
- Offset voltage adjustment
- Adjustable maintenance detection alarm level (3 levels)
- The built-in sensor can be switched on and off.



## Transition wiring may be used. IZS 41 IZS 42

### Total number of ionizers that may be connected

**IZS41: Max. 8 units IZS42: Max. 5 units**

<Conditions> Bar length 340 to 2500 mm, Power supply cable 3 m, Transition wiring cable 2 m

### Reduced labor hours required to connect wires to the power supply

**IZS41**

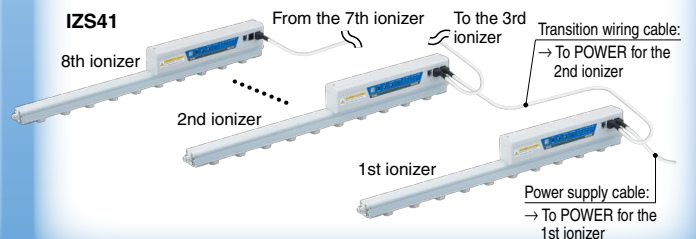

## Safety functions IZS 40 IZS 41 IZS 42

- Emitter cartridge drop prevention function

Double-action locking

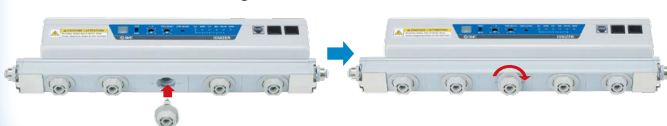

- Drop prevention cover

For increased cartridge drop prevention

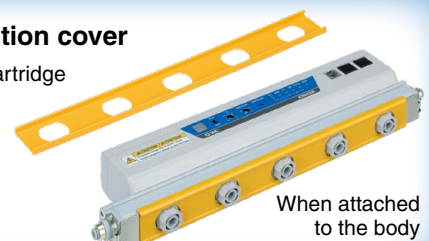

When attached to the body

# Ionizer IZS40/41/42 Series

## Models and Functions

Series		IZS42	IZS41	IZS40
Method of applying voltage		Dual AC	AC, Sensing AC, DC	AC, DC
Auto balance sensor	Built-in type (Standard)	●	●	—
	High accuracy type (Option)	●	●	—
Feedback sensor (Option)		—	●	—
I/O		●	●	—
Transition wiring may be used. *1		●	●	—
Maintenance detection		●	●	—
Incorrect high voltage warning		●	●	●
Low maintenance emitter		●	●	●
Emitter cartridge type	High speed static neutralization	●	●	—
	Energy saving static neutralization	●	●	●
	Energy saving high-efficiency	—	—	●
With One-touch fitting	Metric size $\phi 4$ , $\phi 6$ , $\phi 8$ , $\phi 10$	●	●	●
	Inch size $\phi 3/16$ ", $\phi 1/4$ ", $\phi 5/16$ ", $\phi 3/8$ "	●	●	●
Bracket mount		●	●	●
Non-standard bar length (Made to order)		●	●	●

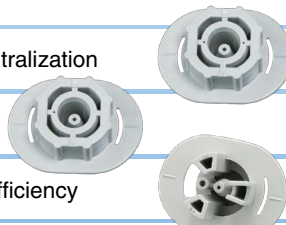
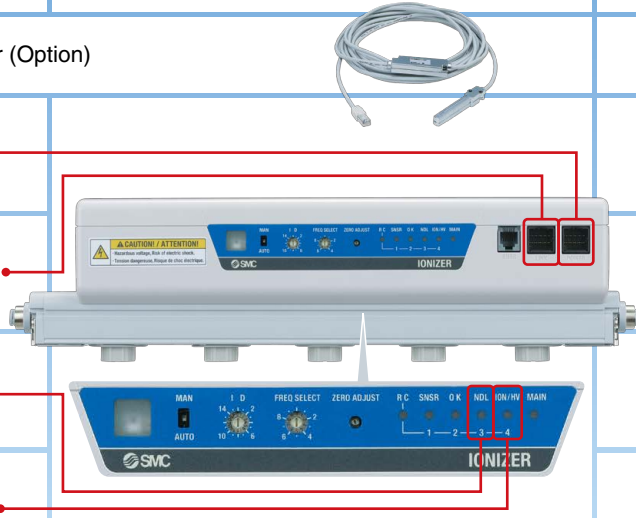

### Accessories sold separately (per series)

\*1 Order transition wiring separately.

Series	IZS42	IZS41	IZS40
Remote controller	●	●	—
AC adapter	●	●	●
Drop prevention cover	●	●	●
Cleaning kit	●	●	●





# Application Examples

## For the static neutralization of films

- Prevents the adhesion of dust
- Prevents winding failure due to wrinkles, etc.

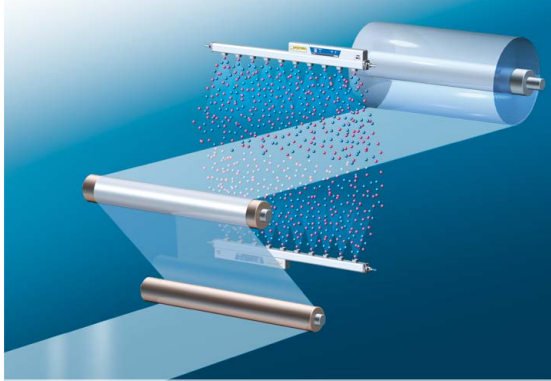

## For the static neutralization of film-molded goods

- Prevents goods from adhering to the conveyor
- Prevents the dispersion of finished goods

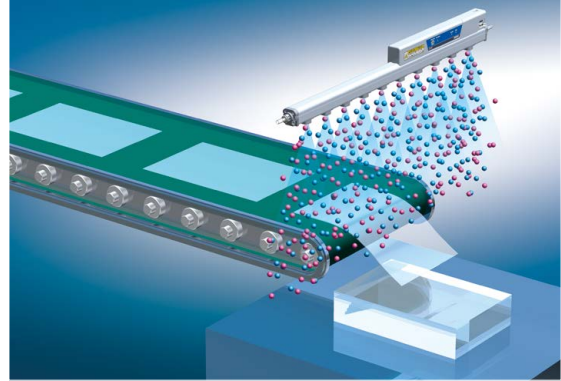

## For the static neutralization during wafer transfer

- Prevents breakage due to discharge between wafers and hands

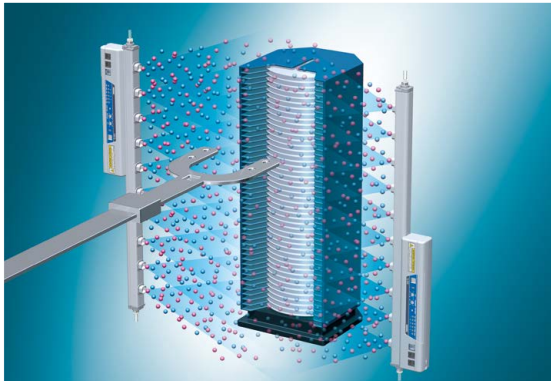

## For the static neutralization of packing films

- Prevents the filled substances from adhering to packing films
- Reduces packing mistakes

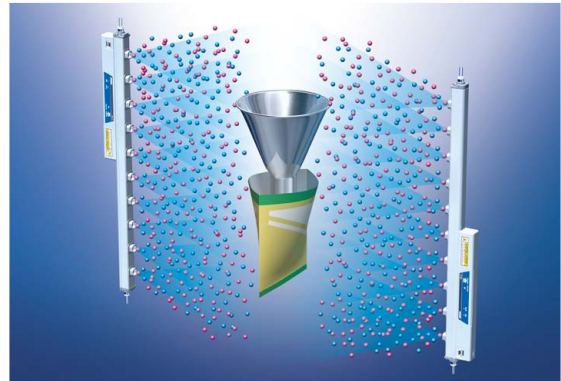

## For the static neutralization of lenses

- Removes dust from lenses
- Prevents the adhesion of dust

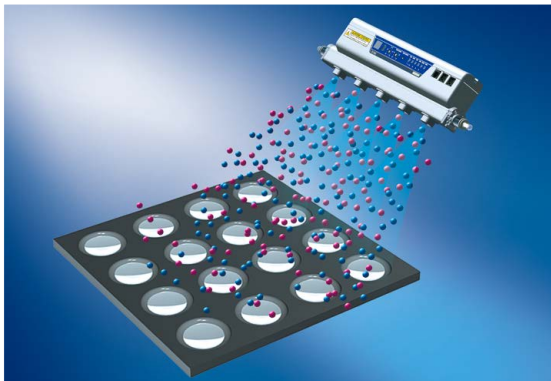

## For the static neutralization of parts feeders

- Prevents the clogging of parts feeders

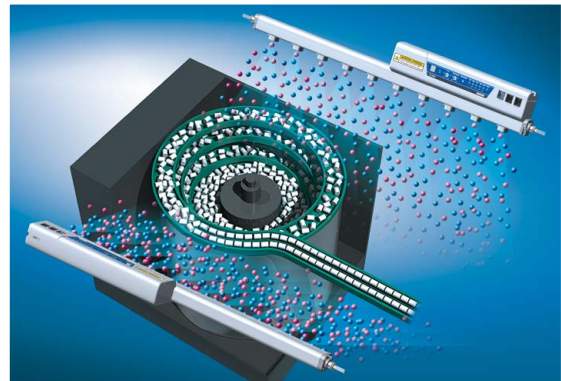

# CONTENTS

## Ionizer *IZS40/41/42 Series*

### Dual AC Type *IZS42 Series*

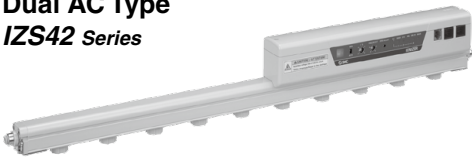

### Feedback Sensor Type *IZS41 Series*

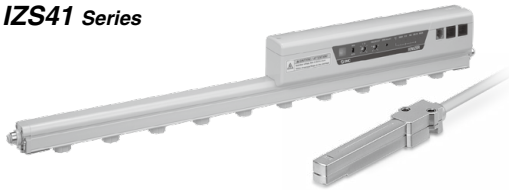

### Standard Type *IZS40 Series*

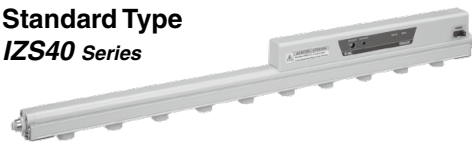

### Technical Data: Static Neutralization Characteristics

① Installation Distance and Discharge Time .....	p. 9
② Static Neutralization Range .....	p. 10
③ Potential Amplitude .....	p. 13
④ Pressure — Flow Rate Characteristics .....	p. 14
Feedback Sensor Detection Range .....	p. 14
How to Order .....	p. 15
Made to Order .....	p. 16
Specifications .....	p. 17
Construction .....	p. 17
Accessories (for Individual Parts) .....	p. 18
Accessories Sold Separately .....	p. 19
Wiring: IZS40 .....	p. 20
Connection Circuit: IZS40 .....	p. 20
Wiring: IZS41, 42 .....	p. 21
Wiring Circuit: IZS41, 42 .....	p. 22
Dimensions .....	p. 23
Specific Product Precautions .....	p. 27

# IZS40/41/42 Series

## Technical Data

\* Static neutralization characteristics are based on data using a charged plate (dimensions: 150 mm x 150 mm, capacitance: 20 pF) as defined in the U.S. ANSI standards (ANSI/ESD STM3.1-2015). For "Sensing AC" mode, the installation height of the sensor is 25 mm. Use this data only as a guideline for model selection because the values vary depending on the material and/or size of the subject.

### Static Neutralization Characteristics

#### ① Installation Distance and Discharge Time (Discharge Time from 1000 V to 100 V)

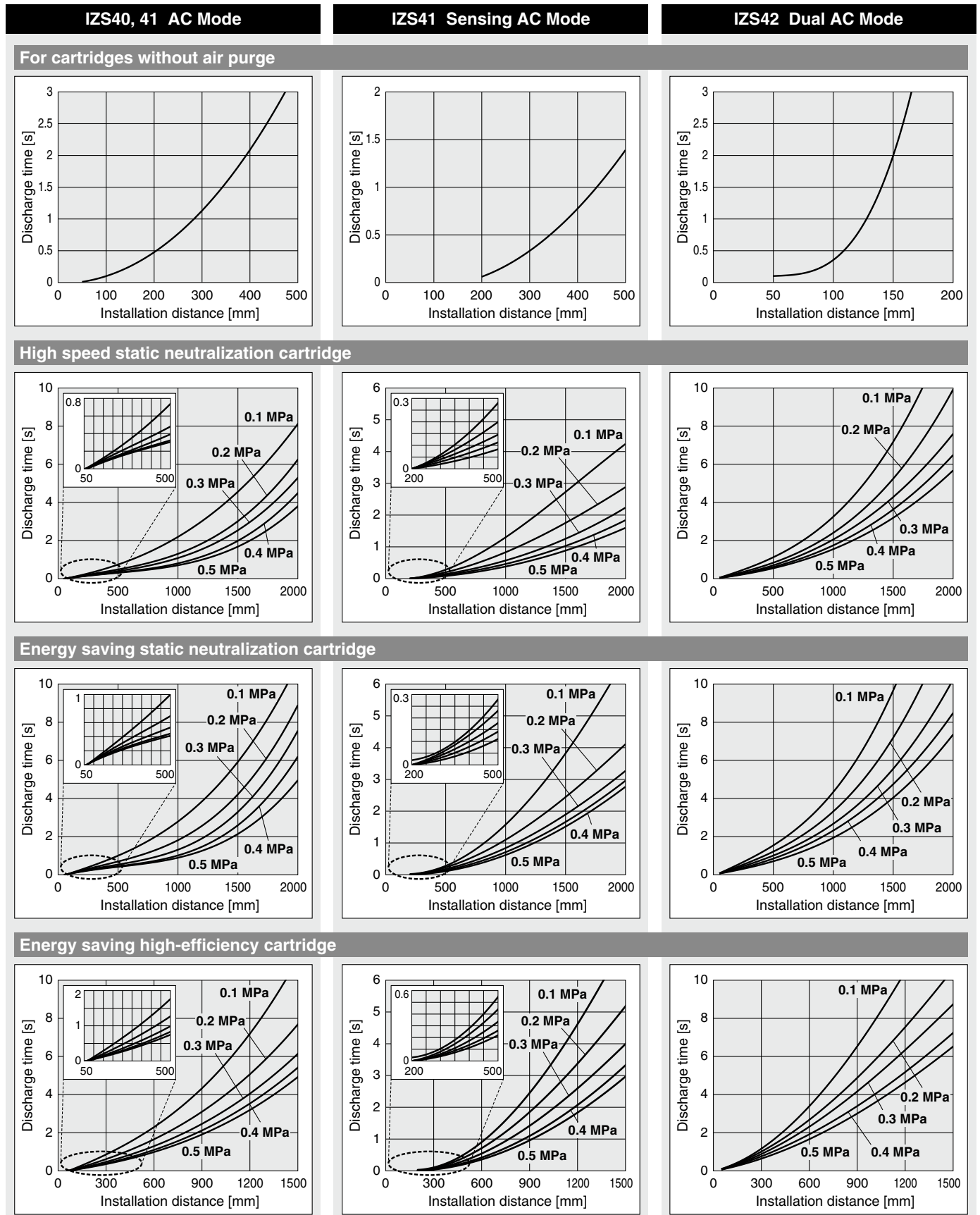



## Static Neutralization Characteristics

\* Static neutralization characteristics are based on data using a charged plate (dimensions: 150 mm x 150 mm, capacitance: 20 pF) as defined in the U.S. ANSI standards (ANSI/ESD STM3.1-2015). Use this data only as a guideline for model selection because the values vary depending on the material and/or size of the subject.

### ② Static Neutralization Range (Discharge Time from 1000 V to 100 V)

#### IZS40, 41 Ion Generation Frequency: 30 Hz

##### 1) For cartridges without air purge

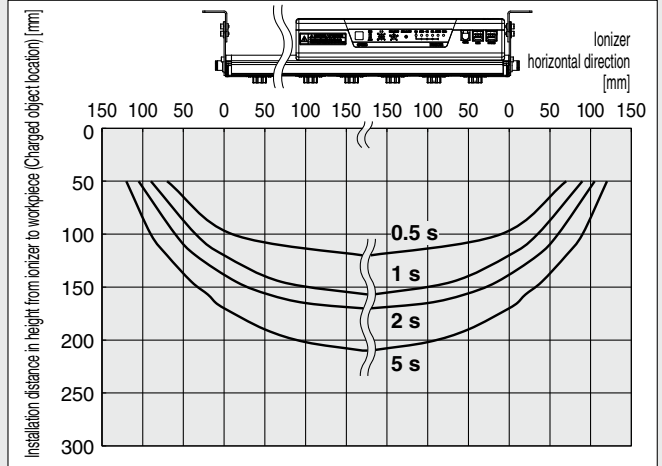
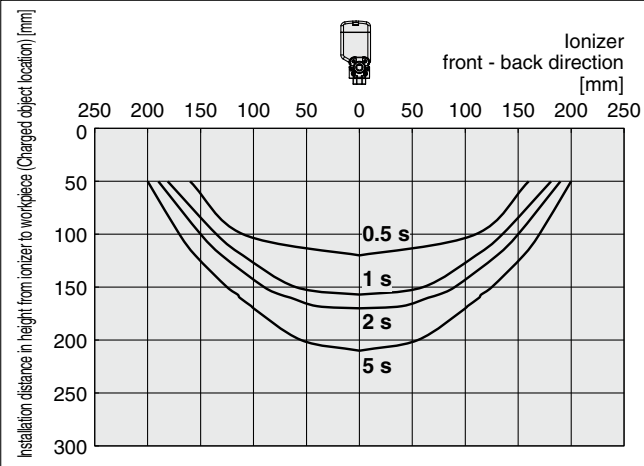

##### 2) High speed static neutralization cartridge, Supply pressure: 0.3 MPa

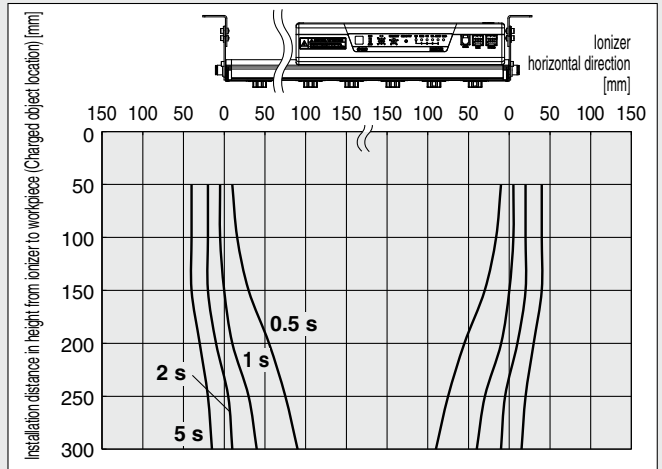
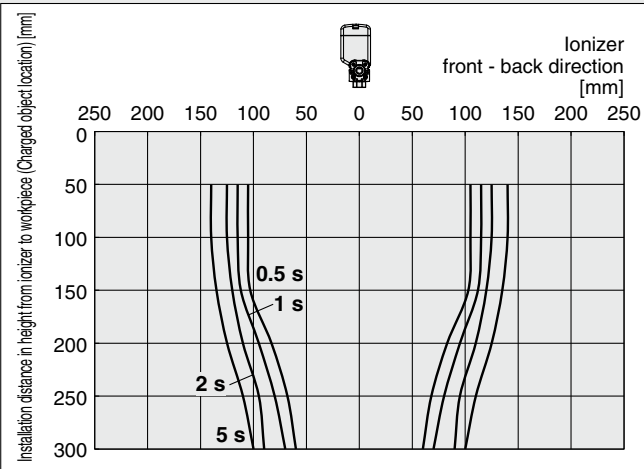

##### 3) Energy saving static neutralization cartridge, Supply pressure: 0.3 MPa

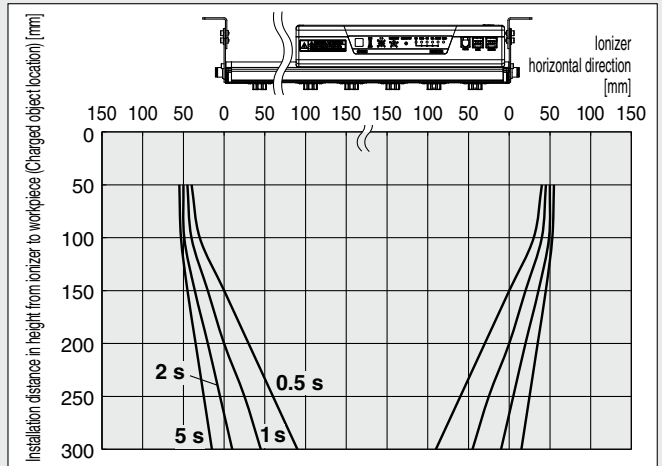
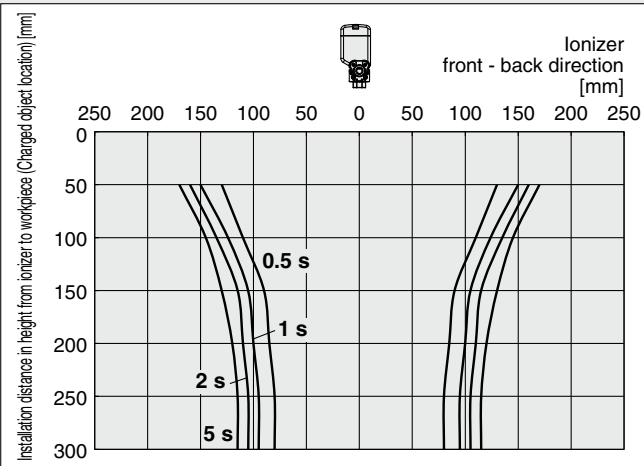

# IZS40/41/42 Series

## Static Neutralization Characteristics

\* Static neutralization characteristics are based on data using a charged plate (dimensions: 150 mm x 150 mm, capacitance: 20 pF) as defined in the U.S. ANSI standards (ANSI/ESD STM3.1-2015). Use this data only as a guideline for model selection because the values vary depending on the material and/or size of the subject.

### ② Static Neutralization Range (Discharge Time from 1000 V to 100 V)

#### IZS40, 41 Ion Generation Frequency: 30 Hz

##### 4) Energy saving high-efficiency cartridge, Supply pressure: 0.3 MPa

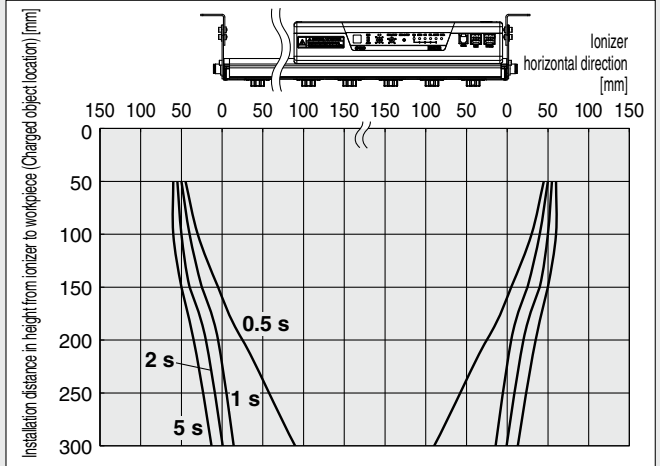
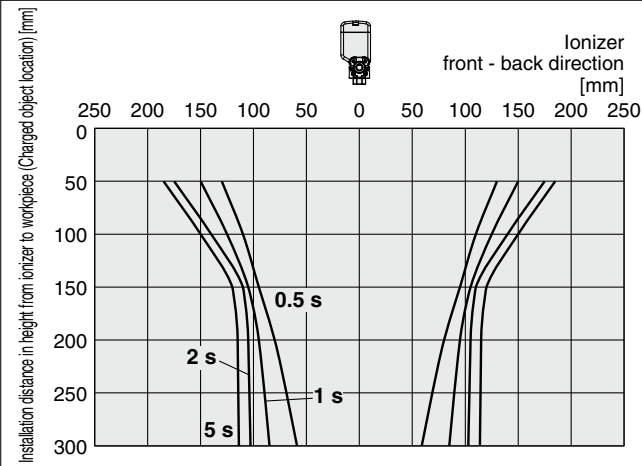

#### IZS42 Ion Generation Frequency: 30 Hz

##### 1) For cartridges without air purge

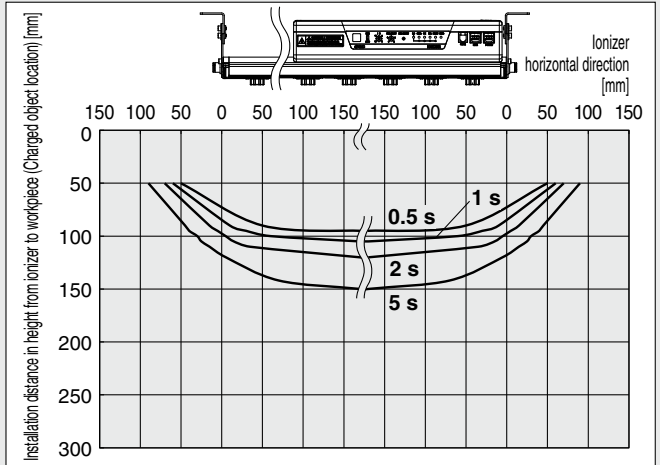
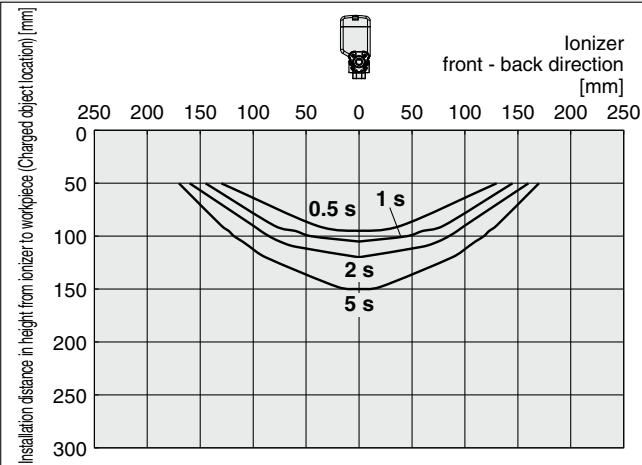

##### 2) High speed static neutralization cartridge, Supply pressure: 0.3 MPa

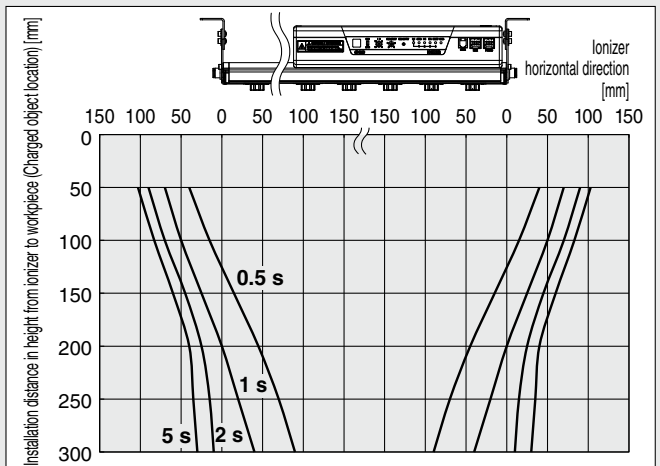
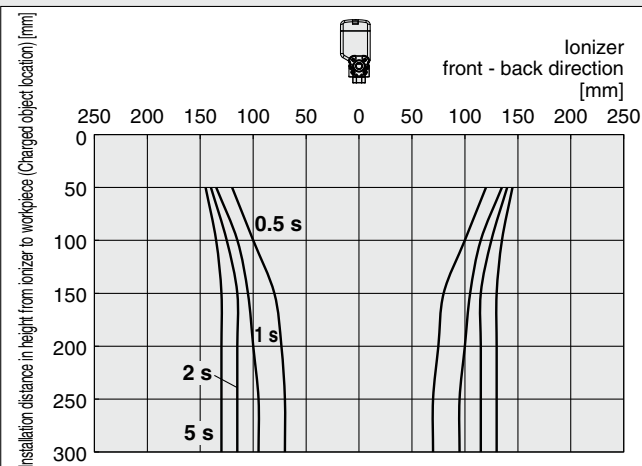

## Static Neutralization Characteristics

\* Static neutralization characteristics are based on data using a charged plate (dimensions: 150 mm x 150 mm, capacitance: 20 pF) as defined in the U.S. ANSI standards (ANSI/ESD STM3.1-2015). Use this data only as a guideline for model selection because the values vary depending on the material and/or size of the subject.

### ② Static Neutralization Range (Discharge Time from 1000 V to 100 V)

#### IZS42 Ion Generation Frequency: 30 Hz

##### 3) Energy saving static neutralization cartridge, Supply pressure: 0.3 MPa

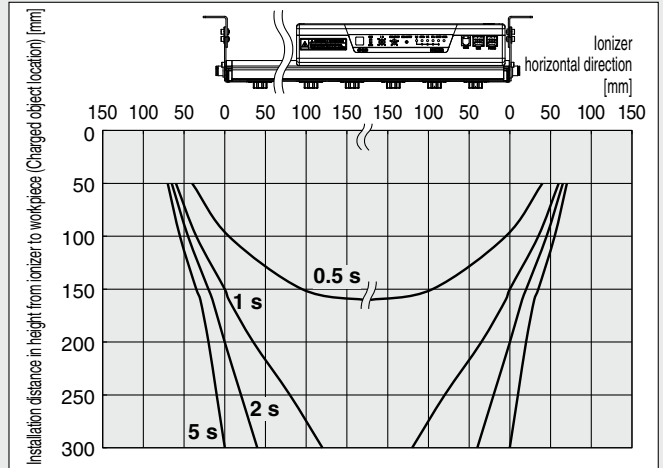
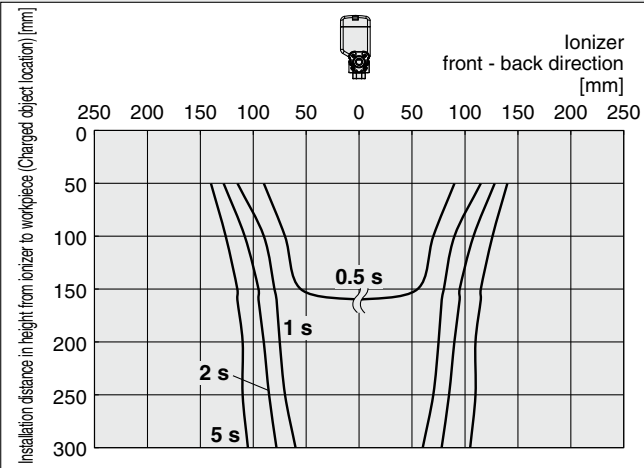

##### 4) Energy saving high-efficiency cartridge, Supply pressure: 0.3 MPa

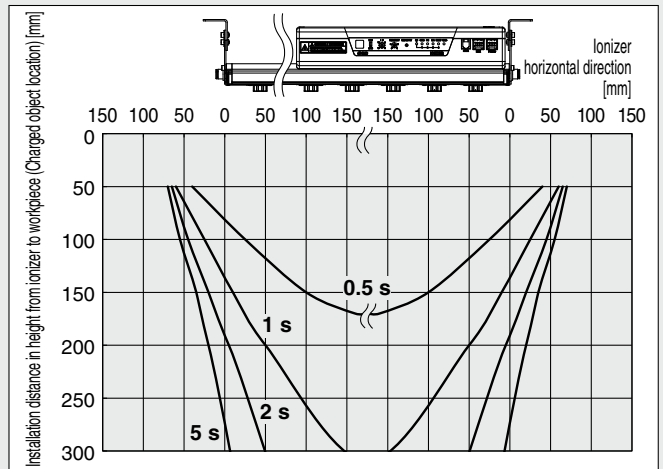
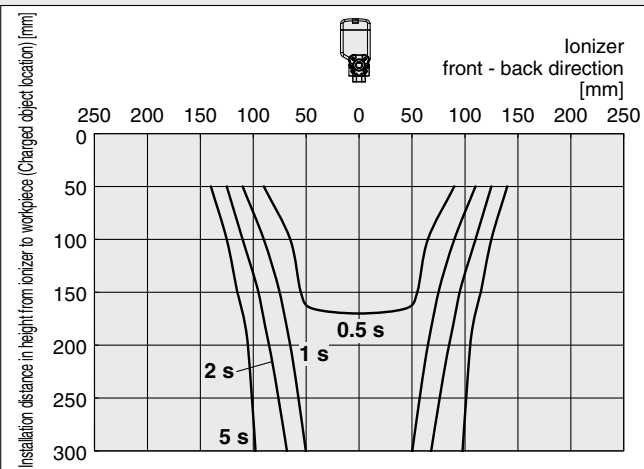



# IZS40/41/42 Series

## Static Neutralization Characteristics

\* Static neutralization characteristics are based on data using a charged plate (dimensions: 150 mm x 150 mm, capacitance: 20 pF) as defined in the U.S. ANSI standards (ANSI/ESD STM3.1-2015). Use this data only as a guideline for model selection because the values vary depending on the material and/or size of the subject.

### ③ Potential Amplitude

**IZS40, 41 Supply Pressure: 0.3 MPa**

**IZS42 Supply Pressure: 0.3 MPa**

#### High speed static neutralization cartridge

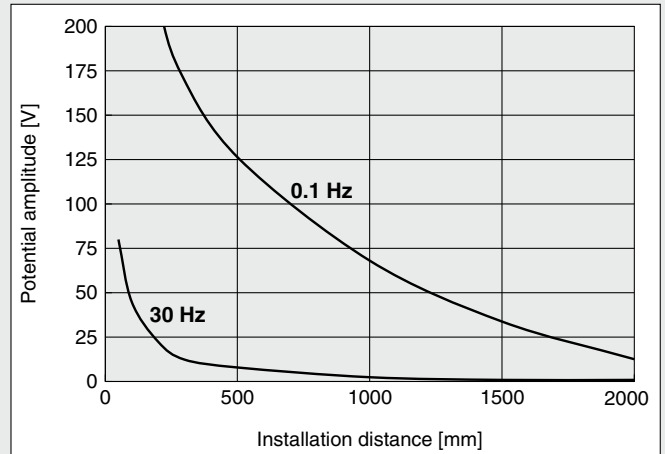
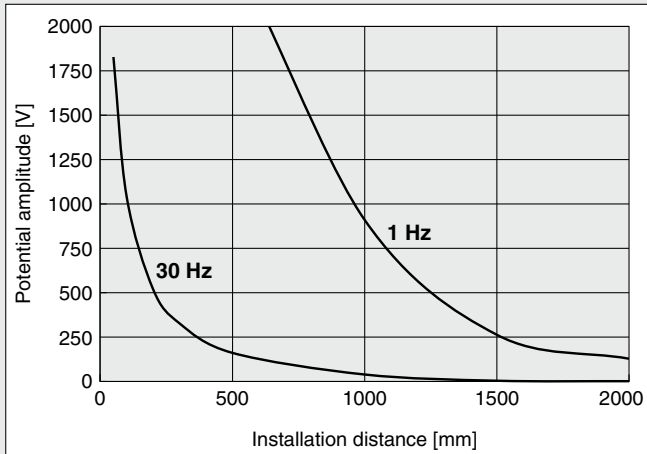

#### Energy saving static neutralization cartridge

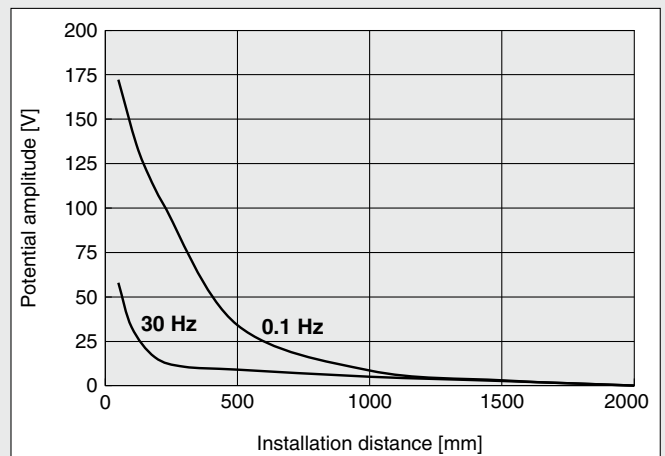
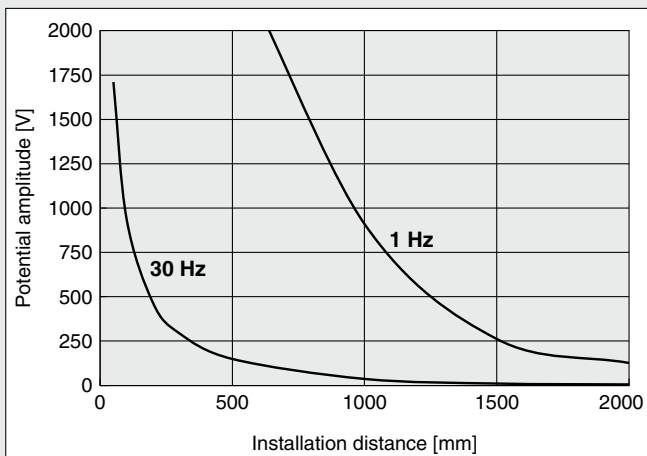

#### Energy saving high-efficiency cartridge

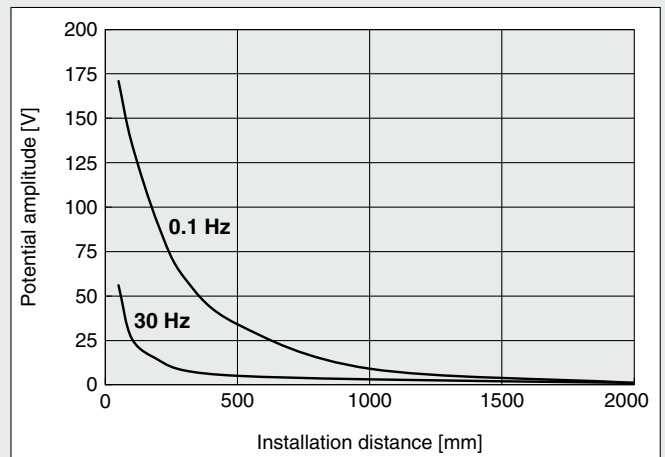
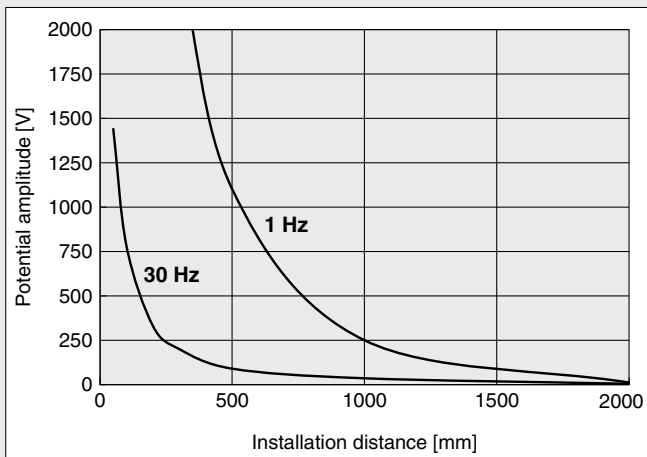

## Static Neutralization Characteristics

\* Static neutralization characteristics are based on data using a charged plate (dimensions: 150 mm x 150 mm, capacitance: 20 pF) as defined in the U.S. ANSI standards (ANSI/ESD STM3.1-2015). Use this data only as a guideline for model selection because the values vary depending on the material and/or size of the subject.

### ④ Pressure — Flow Rate Characteristics

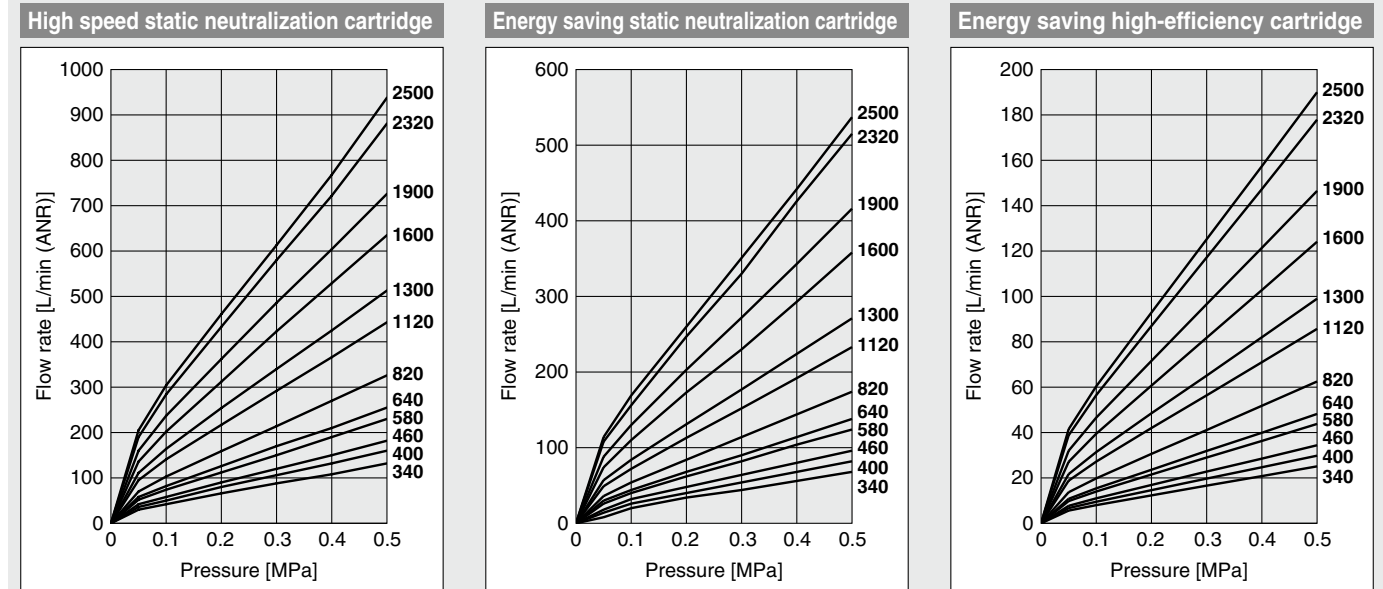

### How to measure

**a) Air supply from one side (Connecting tube: O.D.  $\phi 6$  x I.D.  $\phi 4$ ) (IZS4□-340, 400, 460, 580, 640)**

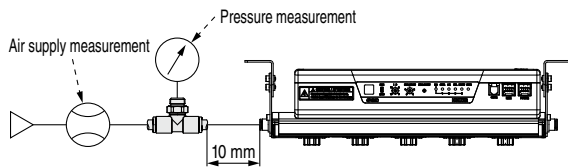

**b) Air supply from both sides (Connecting tube: O.D.  $\phi 6$  x I.D.  $\phi 4$ ) (IZS4□-820, 1120, 1300)**

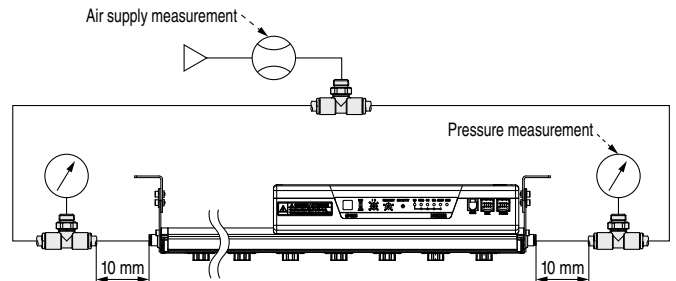

**c) Air supply from both sides (Connecting tube: O.D.  $\phi 8$  x I.D.  $\phi 5$ ) (IZS4□-1600, 1900, 2320, 2500)**

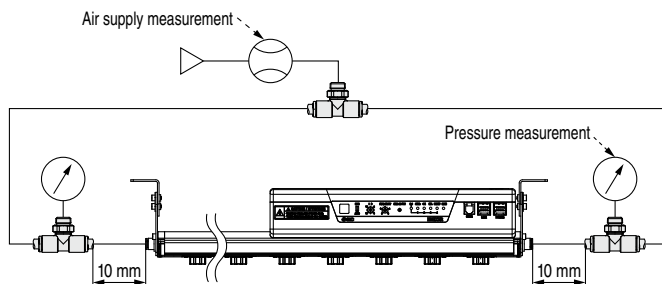

## Feedback Sensor Detection Range

The relationship between the feedback sensor's installation distance and the detection range is as follows:

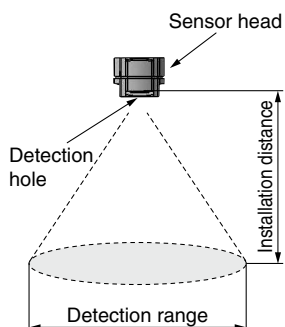

[mm]	
Installation distance	Detection range
10	45
25	100
50	180

### Enlarged view of sensor head

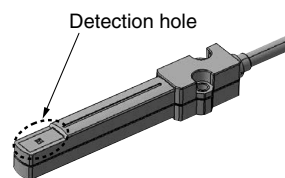

# Ionizer

# IZS40/41/42 Series



## How to Order

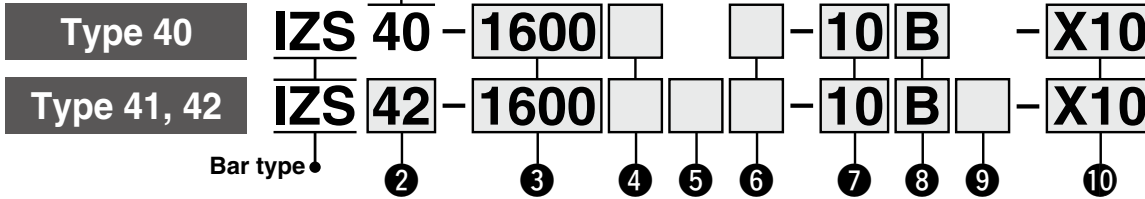
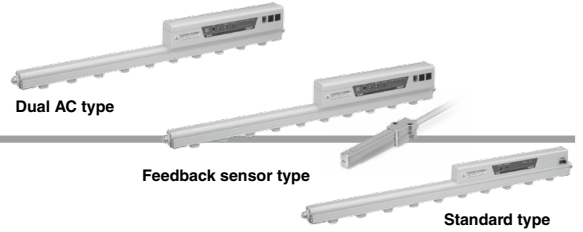

### 1 Type

40	Standard type
----	---------------

### 4 Emitter cartridge type/Emitter material

Symbol	Emitter cartridge type	Emitter material
Nil	High speed static neutralization cartridge	Tungsten
C	Energy saving static neutralization cartridge	Silicon
J	Energy saving high-efficiency cartridge	Tungsten
K	Energy saving high-efficiency cartridge	Silicon
V	Energy saving high-efficiency cartridge	Tungsten
S	Energy saving high-efficiency cartridge	Silicon

### 7 One-touch fitting

04	ø4 One-touch fitting
06	ø6 One-touch fitting
08	ø8 One-touch fitting
10	ø10 One-touch fitting
05	ø3/16" One-touch fitting
07	ø1/4" One-touch fitting
09	ø5/16" One-touch fitting
11	ø3/8" One-touch fitting

- \* Refer to the recommended piping port size in the table on the right for selecting a One-touch fitting.
- \* Please order a plug (part no.: KQ2P-□) separately if the product is to be used with piping only on one side.
- \* The One-touch fitting cannot be changed after the delivery of the product.

### 8 Bracket

Nil	Without bracket
B	With bracket*1

- \*1 The number of intermediate brackets differ depending on the bar length. (Refer to the table below.)

#### Number of brackets

Bar length symbol	End bracket	Intermediate bracket
340 to 760	2	None
820 to 1600		1
1660 to 2380		2
2440 to 2500		3

### 9 Sensor

Symbol	Sensor	IZS41	IZS42
Nil	Built-in sensor	●	●
F	Feedback sensor	●	—
G	Auto balance sensor [High accuracy type]	●	●

- \* The feedback sensor cannot be selected for the IZS42.

### 10 Made to order

Symbol	Description
-X10	Non-standard bar length
-X14	Model with drop prevention cover

### 2 Type

41	Feedback sensor type
42	Dual AC type

### 5 Input/Output

Nil	NPN
P	PNP

- \* The input/output function cannot be used when the AC adapter is being used.

### 6 Power supply cable

Nil	With power supply cable (3 m)
Z	With power supply cable (10 m)
N	Without power supply cable

- \* When only an e-con connector for the IZS40 is required, specify "N," and order the part (Model: ZS-28-C) separately.

- \* To use with an AC adapter, specify "N," and select the AC adapter on page 19 which is sold separately. (A cord is attached to the AC adapter.)

#### Recommended piping port size for the IZS4□ High speed static neutralization cartridge

One-touch fitting symbol	Applicable tubing O.D.	Bar length symbol												
		340	400	460	580	640	820	1120	1300	1600	1900	2320	2500	
04	ø4 mm	●	●	●	—	—	—	—	—	—	—	—	—	—
06	ø6 mm	○	○	○	○	○	●	●	●	—	—	—	—	—
08	ø8 mm	○	○	○	○	○	○	○	○	●	●	●	●	—
10	ø10 mm	○	○	○	○	○	○	○	○	○	○	○	○	○
05	ø3/16"	○	○	○	●	●	●	—	—	—	—	—	—	—
07	ø1/4"	○	○	○	○	○	○	○	○	○	○	○	○	○
09	ø5/16"	○	○	○	○	○	○	○	○	○	○	○	○	○
11	ø3/8"	○	○	○	○	○	○	○	○	○	○	○	○	○

- : With piping only on one side ●: With piping on both sides —: Unrecommended piping

#### Energy saving static neutralization cartridge

One-touch fitting symbol	Applicable tubing O.D.	Bar length symbol												
		340	400	460	580	640	820	1120	1300	1600	1900	2320	2500	
04	ø4 mm	○	○	○	○	○	○	○	○	○	○	○	○	○
06	ø6 mm	○	○	○	○	○	○	○	○	○	○	○	○	○
08	ø8 mm	○	○	○	○	○	○	○	○	○	○	○	○	○
10	ø10 mm	○	○	○	○	○	○	○	○	○	○	○	○	○
05	ø3/16"	○	○	○	○	○	○	○	○	○	○	○	○	○
07	ø1/4"	○	○	○	○	○	○	○	○	○	○	○	○	○
09	ø5/16"	○	○	○	○	○	○	○	○	○	○	○	○	○
11	ø3/8"	○	○	○	○	○	○	○	○	○	○	○	○	○

- : With piping only on one side ●: With piping on both sides —: Unrecommended piping

#### Energy saving high-efficiency cartridge

One-touch fitting symbol	Applicable tubing O.D.	Bar length symbol												
		340	400	460	580	640	820	1120	1300	1600	1900	2320	2500	
04	ø4 mm	○	○	○	○	○	○	○	○	○	○	○	○	○
06	ø6 mm	○	○	○	○	○	○	○	○	○	○	○	○	○
08	ø8 mm	○	○	○	○	○	○	○	○	○	○	○	○	○
10	ø10 mm	○	○	○	○	○	○	○	○	○	○	○	○	○
05	ø3/16"	○	○	○	○	○	○	○	○	○	○	○	○	○
07	ø1/4"	○	○	○	○	○	○	○	○	○	○	○	○	○
09	ø5/16"	○	○	○	○	○	○	○	○	○	○	○	○	○
11	ø3/8"	○	○	○	○	○	○	○	○	○	○	○	○	○

- : With piping only on one side ●: With piping on both sides

## Made to Order

Symbol	Description	Specifications
-X10	Non-standard bar length	Manufacturable bar length [mm]: 460 + 60 x n (n: Integer from 1 to 34) (For n = 2, 3, 6, 11, 14, 19, 24, 31, and 34, use a standard model.)

Ordering example) **IZS 40 - 1660** □ □ - 10 B -X10  
**IZS 42 - 1660** □ □ □ - 10 B □ -X10

Standard model no. ⇨ page 15

● Type

41
42

● Bar length

520	1000	1420	1780	2140
700	1060	1480	1840	2200
760	1180	1540	1960	2260
880	1240	1660	2020	2380
940	1360	1720	2080	2440

Symbol	Description	Specifications
-X14	Model with drop prevention cover	The main unit is shipped fitted with a drop prevention cover available as an option.

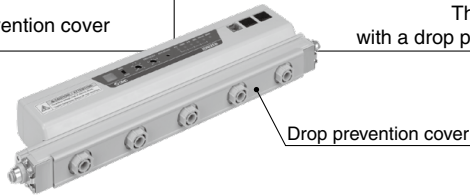

Ordering example) **IZS 40 -** □ □ - 10 B -X14  
**IZS 42 -** □ □ □ - 10 B □ -X14

● Type

41
42

Standard model no. ⇨ page 15

# IZS40/41/42 Series

## Specifications

Ionizer model	IZS40	IZS41-□□ (NPN)	IZS41-□□P (PNP)	IZS42-□□ (NPN)	IZS42-□□P (PNP)	
Ion generation method	Corona discharge type					
Method of applying voltage	AC, DC	AC, Sensing AC, DC		Dual AC		
Applied voltage	±7000 V		±6000 V			
Offset voltage*1	Within ±30 V					
Air purge	Fluid	Air (Clean dry air)				
	Operating pressure	0.5 MPa or less				
	Proof pressure	0.7 MPa				
	Connecting tube size	Metric size: ø4, ø6, ø8, ø10 Inch size: ø3/16", ø1/4", ø5/16", ø3/8"				
Current consumption	330 mA or less	440 mA or less (Sensing AC, Automatic operation/ Manual operation: 480 mA or less)		700 mA or less (Automatic operation/Manual operation: 740 mA or less)		
Power supply voltage	21.6 to 26.4 VDC (Within 24 VDC ±10%)					
Power supply voltage in a transition wiring	24 VDC to 26.4 VDC					
Input signal	Discharge stop signal	—	Connected to 0 V Voltage range: 5 VDC or less Current consumption: 5 mA or less	Connected to +24 V Voltage range: 19 VDC to power supply voltage Current consumption: 5 mA or less	Connected to 0 V Voltage range: 5 VDC or less Current consumption: 5 mA or less	Connected to +24 V Voltage range: 19 VDC to power supply voltage Current consumption: 5 mA or less
	Maintenance detection signal	—	Max. load current: 100 mA Residual voltage: 1 V or less (Load current at 100 mA) Max. applied voltage: 26.4 VDC	Max. load current: 100 mA Residual voltage: 1 V or less (Load current at 100 mA)	Max. load current: 100 mA Residual voltage: 1 V or less (Load current at 100 mA) Max. applied voltage: 26.4 VDC	Max. load current: 100 mA Residual voltage: 1 V or less (Load current at 100 mA)
Output signal	Maintenance detection signal	—				
	Error signal	—				
Function	Incorrect high voltage ion discharge detection (ion discharge stops during detection)	Offset voltage control with the built-in sensor, maintenance detection, incorrect high voltage ion discharge detection (stops discharge during detection), ion discharge stop input, transition wiring, remote controller (sold separately), external sensor connection				
Effective static neutralization distance	50 to 2000 mm	50 to 2000 mm (Sensing AC mode: 200 to 2000 mm, Manual operation/Automatic operation: 100 to 2000 mm)		50 to 2000 mm (Manual operation/Automatic operation: 100 to 2000 mm)		
Ambient and fluid temperatures	0 to 40°C					
Ambient humidity	35 to 80% RH (No condensation)					
Material	Body cover: ABS, Emitter cartridge: PBT, Emitter: Tungsten, Single crystal silicon					
Impact resistance	100 m/s <sup>2</sup>					
Standards/Directive	CE (EMC Directive: 2004/108/EC)					

\*1 When the air purge is performed between a charged object and an ionizer at a distance of 300 mm

## Number of Emitter Cartridges/Bar Weight

Bar length symbol	340	400	460	580	640	820	1120	1300	1600	1900	2320	2500	
Number of emitter cartridges	5	6	7	9	10	13	18	21	26	31	38	41	
Weight [g]	IZS40	590	640	690	790	830	980	1220	1360	1600	1840	2170	2320
	IZS41	740	790	840	940	980	1130	1370	1510	1750	1990	2320	2470
	IZS42	860	910	960	1060	1100	1250	1490	1630	1870	2110	2440	2590

## External Sensor

Sensor model	IZS31-DF (Feedback sensor)	IZS31-DG (Auto balance sensor) [High accuracy type]
Ambient temperature	0 to 50°C	
Ambient humidity	35 to 80% RH (No condensation)	
Case material	ABS	ABS, Stainless steel
Impact resistance	100 m/s <sup>2</sup>	
Weight	200 g (Including cable weight)	220 g (Including cable weight)
Installation distance	10 to 50 mm (Recommended)	—
Standards/Directive	CE, UL, CSA	

## AC Adapter (Sold Separately)

Model	IZF10-CG□, IZS41-CG□
Input voltage	100 VAC to 240 VAC, 50/60 Hz
Output current	1 A
Ambient temperature	0 to 40°C
Ambient humidity	35 to 65% RH (No condensation)
Weight	220 g
Standards/Directive	CE, UL, CSA

## Remote Controller (Sold Separately)

Model	IZS41-RC
Type	Infrared ray type
Transmission capacity	5 m <sup>*1</sup>
Power supply	2 AAA sized batteries (sold separately)*2
Ambient temperature	0 to 45°C
Ambient humidity	35 to 80% RH (No condensation)
Weight	33 g (Excluding dry cell batteries)
Standards/Directive	CE

\*1 Varies depending on the operating conditions and environment

\*2 Batteries are not supplied.

\* Refer to the operation manual for handling of the remote controller.

## Construction

### IZS40 series

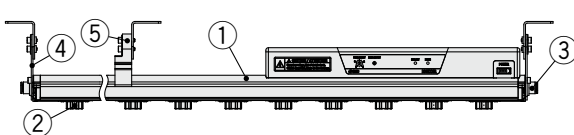

### IZS41, 42 series

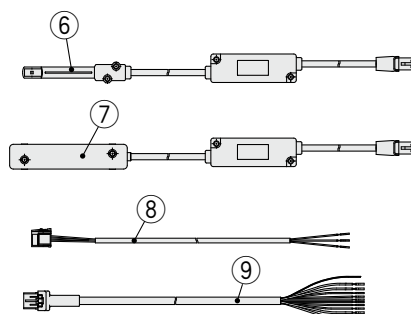
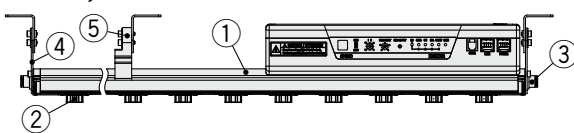

No.	Description
1	Ionizer
2	Emitter cartridge
3	One-touch fitting
4	End bracket
5	Intermediate bracket
6	Feedback sensor
7	Auto balance sensor [High accuracy type]
8	Power supply cable (for IZS40)
9	Power supply cable (for IZS41, 42)



## Accessories (for Individual Parts)

**Feedback sensor**  
**IZS31-DF**



**Auto balance sensor [High accuracy type]**  
**IZS31-DG**



**Power supply cable**

- IZS40-CP (3 m)
- IZS41-CP (3 m)
- IZS40-CPZ (10 m)
- IZS41-CPZ (10 m)

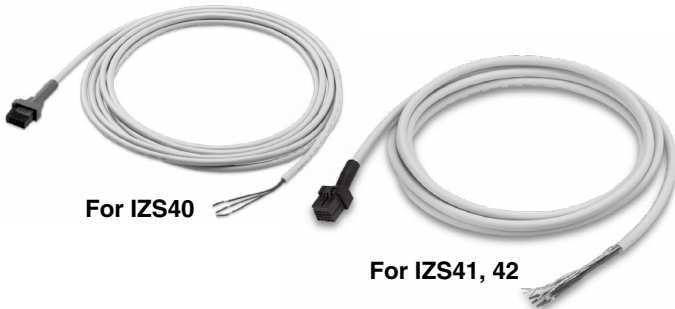

For IZS40

For IZS41, 42

**High speed static neutralization cartridge**

- IZS40-NT (Emitter material: Tungsten)
- IZS40-NC (Emitter material: Silicon)

**Energy saving static neutralization cartridge**

- IZS40-NJ (Emitter material: Tungsten)
- IZS40-NK (Emitter material: Silicon)

**Energy saving high-efficiency cartridge**

- IZS40-NV (Emitter material: Tungsten)
- IZS40-NS (Emitter material: Silicon)



**Tungsten**  
(Emitter cartridge color: White)

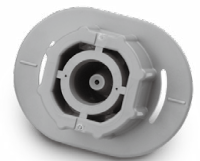

**Silicon**  
(Emitter cartridge color: Gray)

### Made to Order

How to Order

**IZS**    - **CP**    - **X13**

Type ● Power supply cable full length

Symbol	Cable full length
40	For IZS40
41	For IZS41, 42
01	1 m
02	2 m
...	...
19	19 m
20	20 m

**Model with Made-to-order power supply cable**  
Available in 1 m increments from 1 m to 20 m  
\* 11 m or longer power cables are not CE Marking-compliant.  
\* Use standard power supply cables for 3 m and 10 m lengths.

### End bracket IZS40-BE

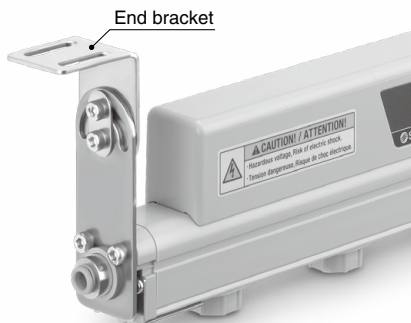

\* Ionizer mounting screws attached, M4 x 8, 2 pcs.

### Intermediate bracket IZS40-BM

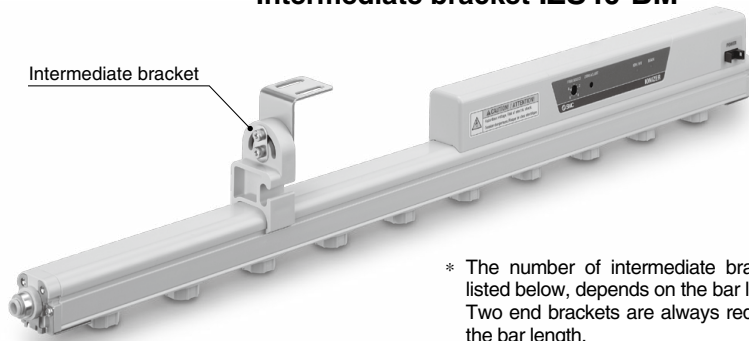

\* The number of intermediate brackets required, as listed below, depends on the bar length.  
Two end brackets are always required regardless of the bar length.

Bar length symbol	End bracket	Intermediate bracket
340 to 760	With 2 pcs.	None
820 to 1600		With 1 pc.
1660 to 2380		With 2 pcs.
2440 to 2500		With 3 pcs.

\* The model number is for a single bracket.

# IZS40/41/42 Series

## Accessories Sold Separately

### Drop prevention cover

## IZS40-E 3

#### Number of fixed emitter cartridges

IZS40-E3	3
IZS40-E4	4
IZS40-E5	5

#### Number of required drop prevention covers

Bar length symbol	Number of required drop prevention covers		
	IZS40-E3	IZS40-E4	IZS40-E5
340	—	—	1
400	2	—	—
460	1	1	—
580	—	1	1
640	—	—	2
820	1	—	2
1120	1	—	3
1300	2	—	3
1600	2	—	4
1900	2	—	5
2320	1	—	7
2500	2	—	7

Mounted part of emitter cartridge

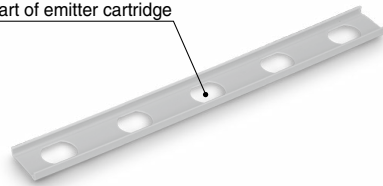

Specify "-X14" at the end of the standard model number when ordering a drop prevention cover attached to the body.

#### Standard model no. - X14



Drop prevention cover

When attached to the body

### Remote controller IZS41-RC



### AC adapter For IZS40

## IZF10-C

#### AC adapter

G1	AC adapter + AC cord
G2	AC adapter (without AC cord)

\* AC cord is only for use in Japan. (Rated voltage 125 V, plug JIS C 8303, inlet IEC60320-C8) External input and output cannot be used when the AC adapter is being used.



For IZS40

### For IZS41, 42

## IZS41-C

#### AC adapter

G1	AC adapter + AC cord
G2	AC adapter (without AC cord)

\* AC cord is only for use in Japan. (Rated voltage 125 V, plug JIS C 8303, inlet IEC60320-C8) External input and output cannot be used when the AC adapter is being used.



For IZS41, 42

### Transition wiring cable

## IZS41 - CF

#### Transition wiring cable

02	Full length 2 m
05	Full length 5 m
08	Full length 8 m



### Made to Order

#### How to Order

## IZS41 - CF - X13

#### Transition wiring cable length

#### Model with Made-to-order transition wiring cable

Available in 1 m increments from 1 m to 20 m

\* 11 m or longer power cables are not CE Marking-compliant.

\* Use standard power supply cables for 2 m, 5 m, and 8 m lengths.

\* Transition wiring is not possible for the IZS40.

Symbol	Cable full length
01	1 m
03	3 m
...	...
19	19 m
20	20 m

### Cleaning kit IZS30-M2



## Wiring: IZS40

Wire cables according to the circuitry and wiring chart.

### 1. Grounding of F.G. cable

Make sure to ground the F.G. cable (green) with a ground resistance of 100 Ω or less.

The F.G. cable is used as a reference electric potential for de-ionization. If the ground terminal is not properly grounded, an optimal offset voltage cannot be acquired and also causes failure of the equipment. Be sure to connect the ground terminal using a ground resistance of 100 Ω or less.

### 2. Connection circuit (“POWER” connector)

#### Wiring of the IZS40

e-con is adopted for the connector of the IZS40. Connector with cable or without cable may be selected when placing an order for the power supply cable. When only an e-con is required, place an order for it as a part. (Cable is not supplied.)

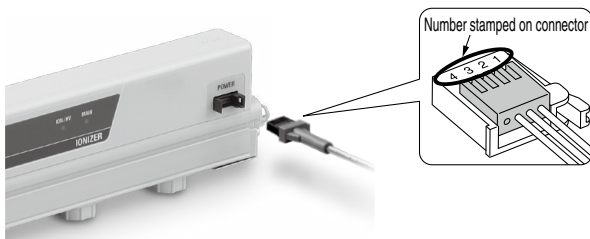

#### Wiring

Number stamped on connector	Signal name	Description
1	+24 VDC	Connect the power supply to operate the ionizer.
2	0 V	
3	F.G.	Make sure to ground with a ground resistance of 100 Ω or less to use it as a reference electric potential for ionizer. If not grounded, performance cannot be acquired, and also causes failure of the equipment.
4	—	Unused

### How to connect the cable of the connector

- 1) Cut the cable as shown in the figure to the below.  
Refer to the following table for the applicable wire size.

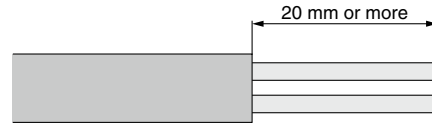

#### Applicable Wire

AWG No.	Conductor cross section [mm <sup>2</sup> ]	Finish O.D. [mm]	Model
26-24	0.14-0.2	ø0.8-ø1.0	ZS-28-C

- 2) Insert the cable which was cut into the back of the connector.
- 3) Confirm that the cable is inserted into the back of the connector and press part A with your finger to hold tentatively.
- 4) Use a tool such as pliers to firmly tighten the center of part A.
- 5) The connector cannot be reused once crimped. If cable insertion fails, use a new connector.

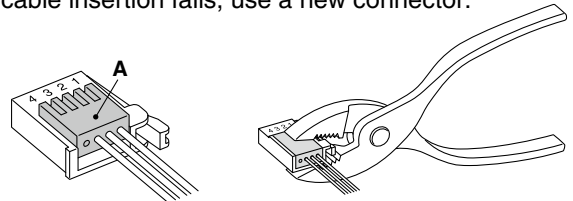

## Connection Circuit: IZS40

### Ionizer (IZS40)

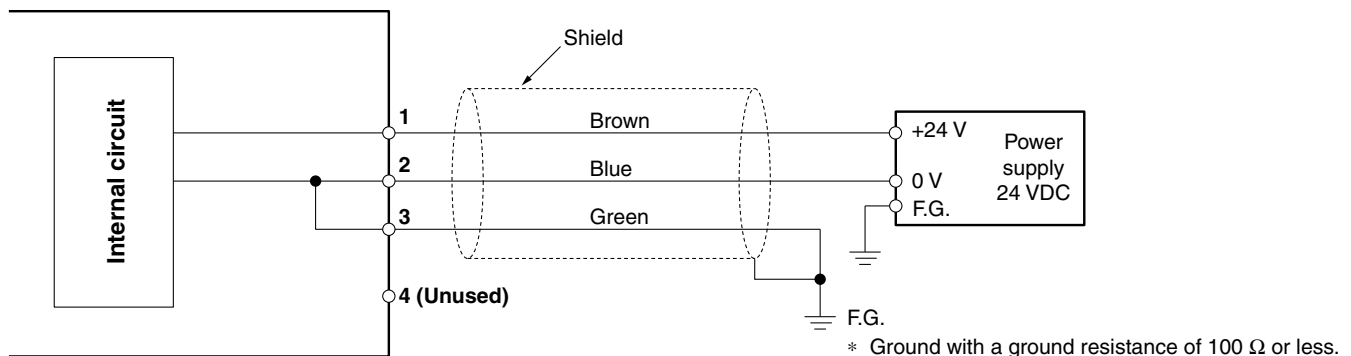

If cables are prepared by the user, the cable colors shown in the diagram may change according to the cable colors by the user.

# IZS40/41/42 Series

## Wiring: IZS41, 42

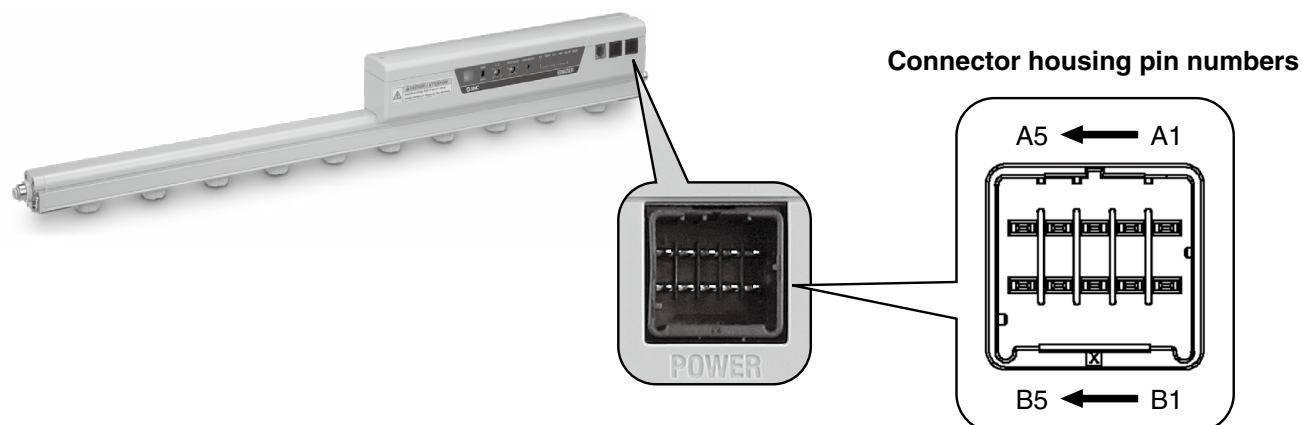

### Wiring

Pin no.	Cable color	Cable size	Signal name	Signal direction	Description
<b>A1</b>	Brown	AWG20 AWG28	+24 VDC	IN	Connect the power supply to operate the ionizer.
<b>B1</b>					
<b>A2</b>	Blue		0 V	IN	Make sure to ground with a ground resistance of 100 Ω or less to use it as a reference electric potential for ionizer. If not grounded, performance cannot be acquired, and also causes failure of the equipment.
<b>B2</b>					
<b>A3</b>	Green		F.G.	—	
<b>B3</b>	Light green		Discharge stop signal	IN	Signal input to turn ON/OFF the ion discharge. NPN specification: Stops ion discharge by connecting to 0 V. (Starts discharging ion when disconnected.) PNP specification: Stops ion discharge by connecting to +24 VDC. (Starts discharging ion when disconnected.)
<b>A4</b>	Gray		Maintenance detection signal	IN	Input signal when determining the necessity of emitter maintenance.
<b>B4</b>	Yellow		Maintenance detection signal	OUT (A contact)	Turns ON when emitters need cleaning.
<b>A5</b>	Purple		Error signal	OUT (B contact)	Turns OFF in case of power supply failure, ion discharge error, connected sensor failure, or CPU operation failure. (ON when there is no problem.)
<b>B5</b>	White		Unused	—	

\* Refer to the power supply cable dimensions on page 26 for the cable specifications.

### Frequencies

Frequency set Switch set no.	Ion generation frequency [Hz], Remote controller		
	IZS40	IZS41	IZS42
<b>0</b>	1	Remote controller*1	Remote controller*1
<b>1</b>	3	1	0.1
<b>2</b>	5	3	0.5
<b>3</b>	8	5	1
<b>4</b>	10	10	3
<b>5</b>	15	15	5
<b>6</b>	20	20	10
<b>7</b>	30	30	15
<b>8</b>	DC+	DC+	20
<b>9</b>	DC-	DC-	30

\*1 Set when remote controller is used.

## Wiring Circuit: IZS41, 42

### NPN specification

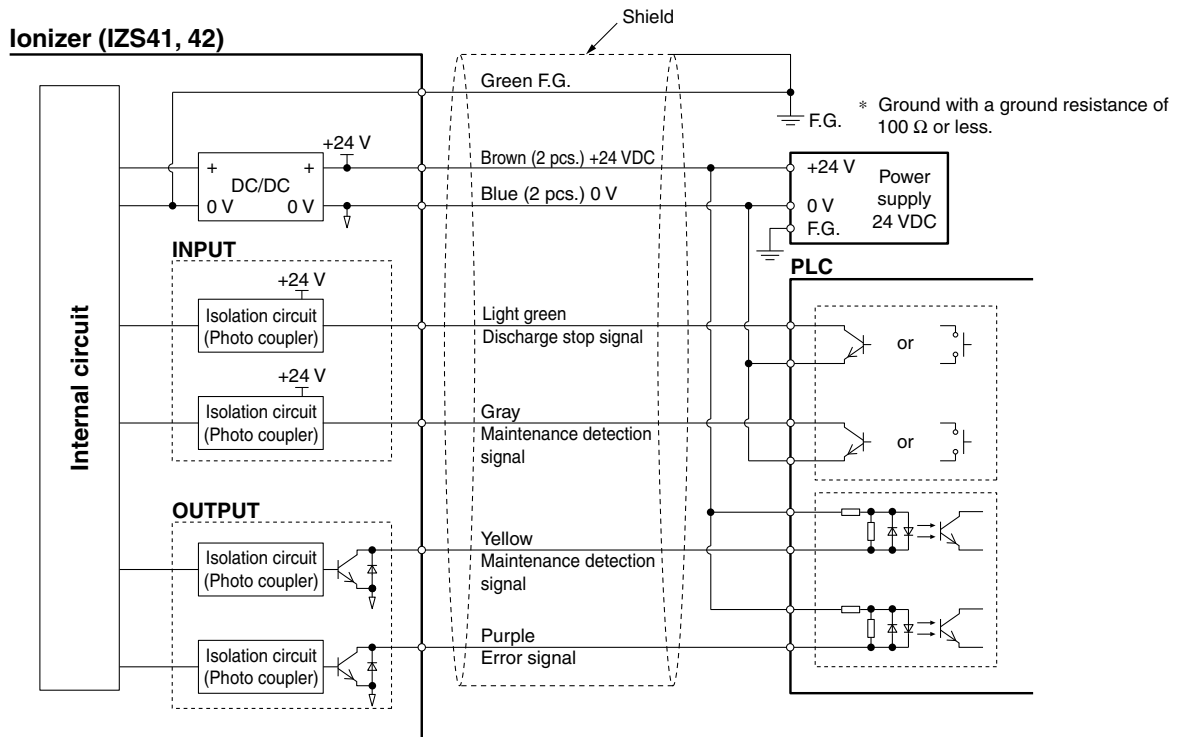

### PNP specification

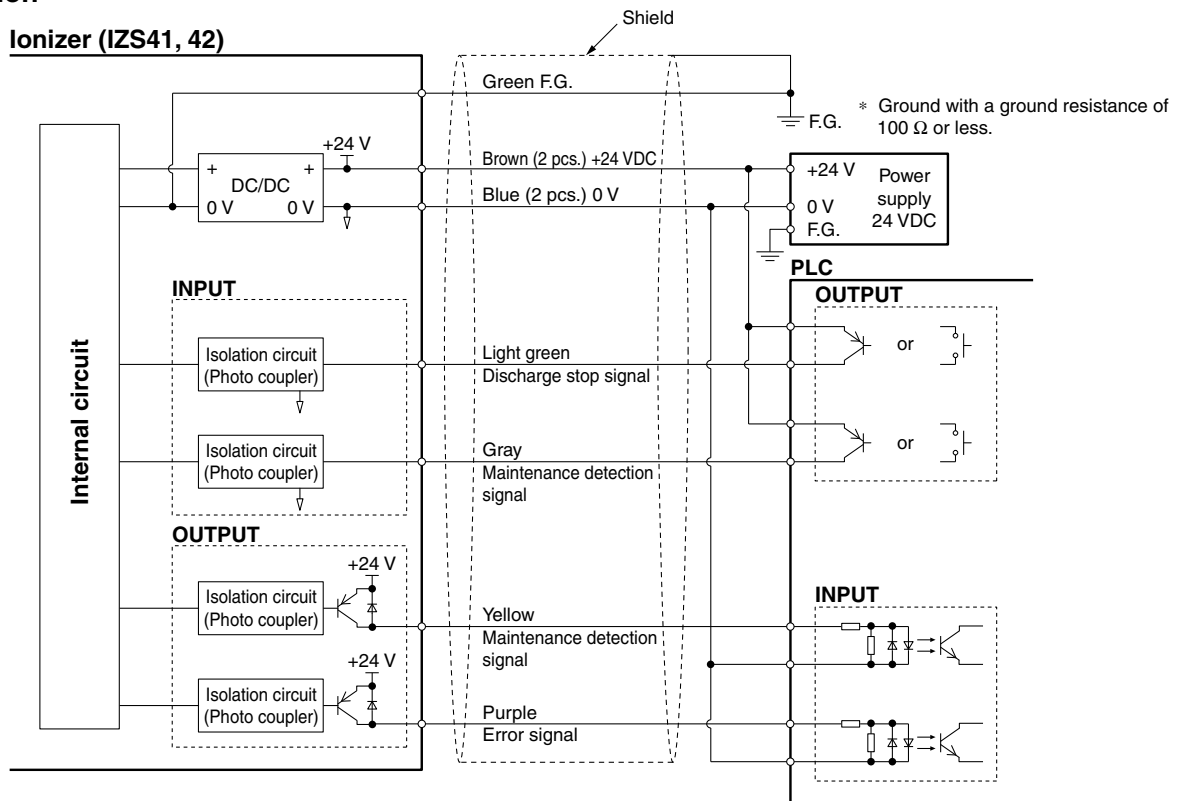



# IZS40/41/42 Series

## Dimensions

### Ionizer IZS40

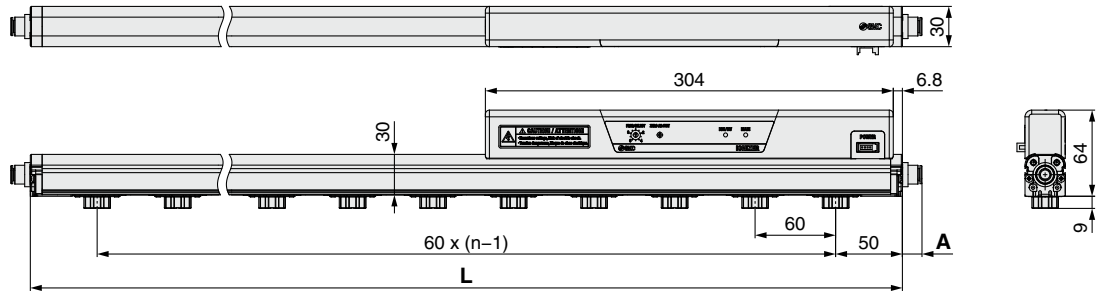

#### One-touch Fittings

	Applicable tubing O.D.	A [mm]
Metric	ø4	13
	ø6	13
	ø8	15
Inch	ø3/16"	15
	ø1/4"	14
	ø5/16"	15
	ø3/8"	23

#### n (Number of emitter cartridges), L Dimensions

Part no.	n	L [mm]
IZS40-340	5	340
IZS40-400	6	400
IZS40-460	7	460
IZS40-580	9	580
IZS40-640	10	640
IZS40-820	13	820
IZS40-1120	18	1120
IZS40-1300	21	1300
IZS40-1600	26	1600
IZS40-1900	31	1900
IZS40-2320	38	2320
IZS40-2500	41	2500

### End bracket IZS40-BE

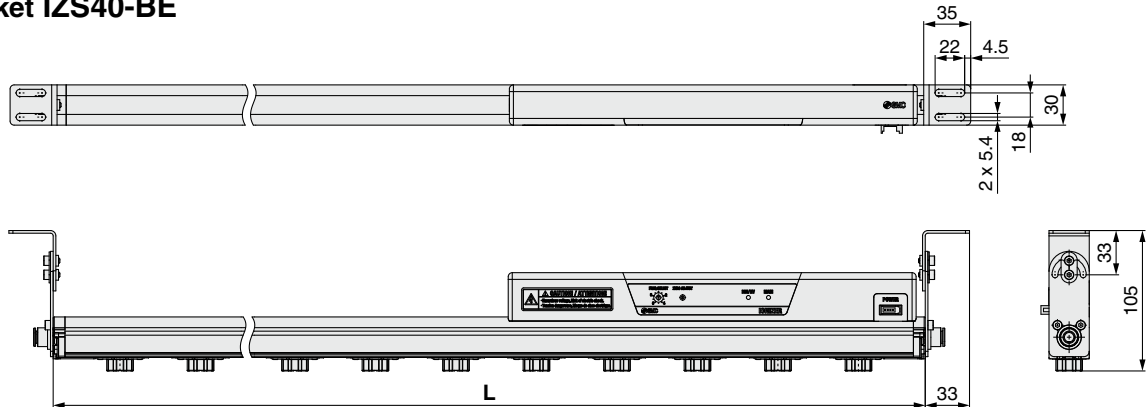

### Intermediate bracket IZS40-BM

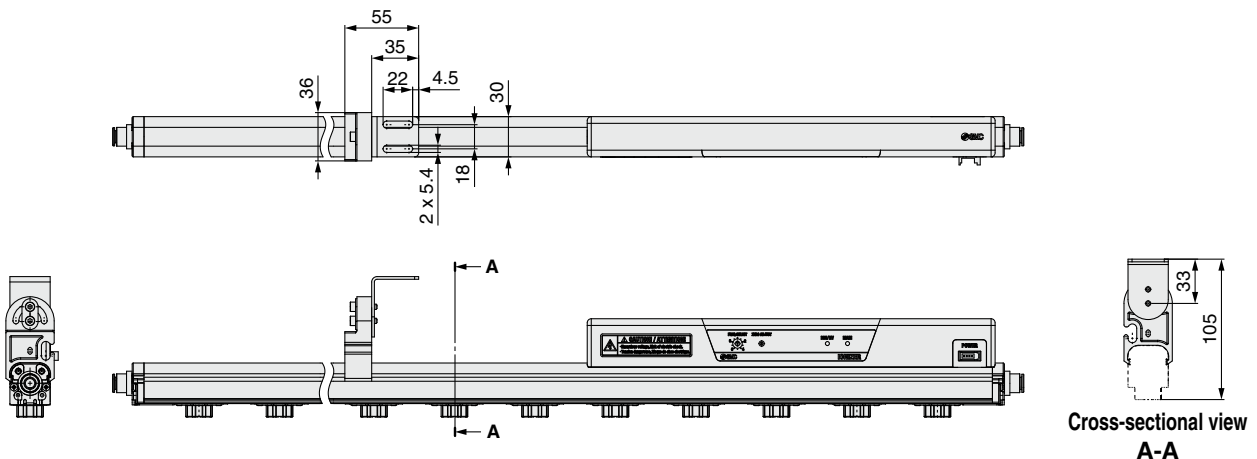

Cross-sectional view  
A-A

## Dimensions

### Ionizer IZS41, 42

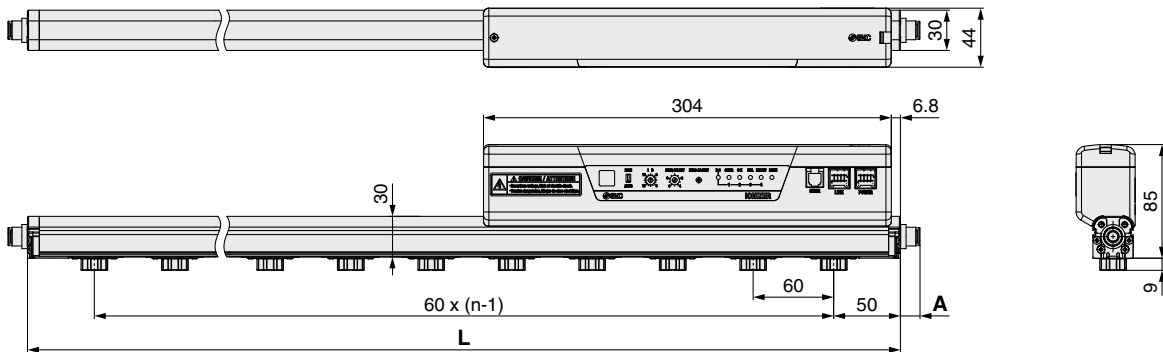

#### One-touch Fittings

	Applicable tubing O.D.	A [mm]
Metric	ø4	13
	ø6	13
	ø8	15
	ø10	22
Inch	ø3/16"	15
	ø1/4"	14
	ø5/16"	15
	ø3/8"	23

#### n (Number of emitter cartridges), L Dimensions

Part no.	n	L [mm]
<b>IZS4□-340</b>	5	340
<b>IZS4□-400</b>	6	400
<b>IZS4□-460</b>	7	460
<b>IZS4□-580</b>	9	580
<b>IZS4□-640</b>	10	640
<b>IZS4□-820</b>	13	820
<b>IZS4□-1120</b>	18	1120
<b>IZS4□-1300</b>	21	1300
<b>IZS4□-1600</b>	26	1600
<b>IZS4□-1900</b>	31	1900
<b>IZS4□-2320</b>	38	2320
<b>IZS4□-2500</b>	41	2500

### End bracket IZS40-BE

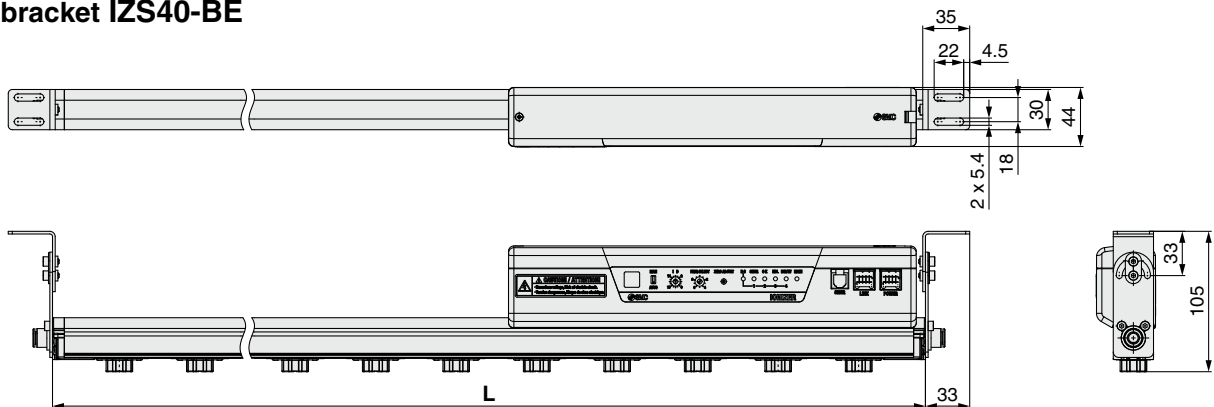

### Intermediate bracket IZS40-BM

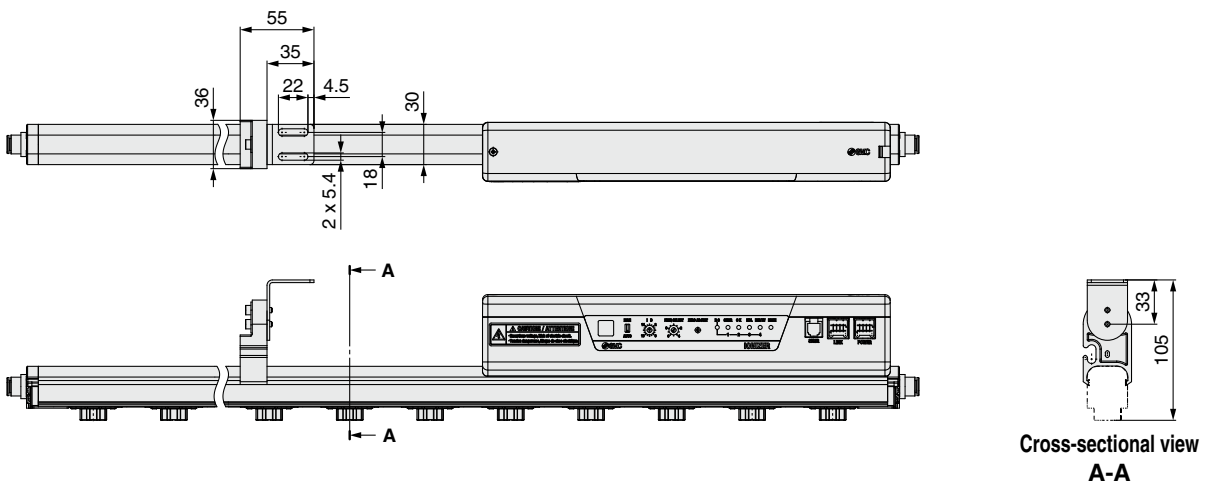

# IZS40/41/42 Series

## Dimensions

### Feedback sensor IZS31-DF

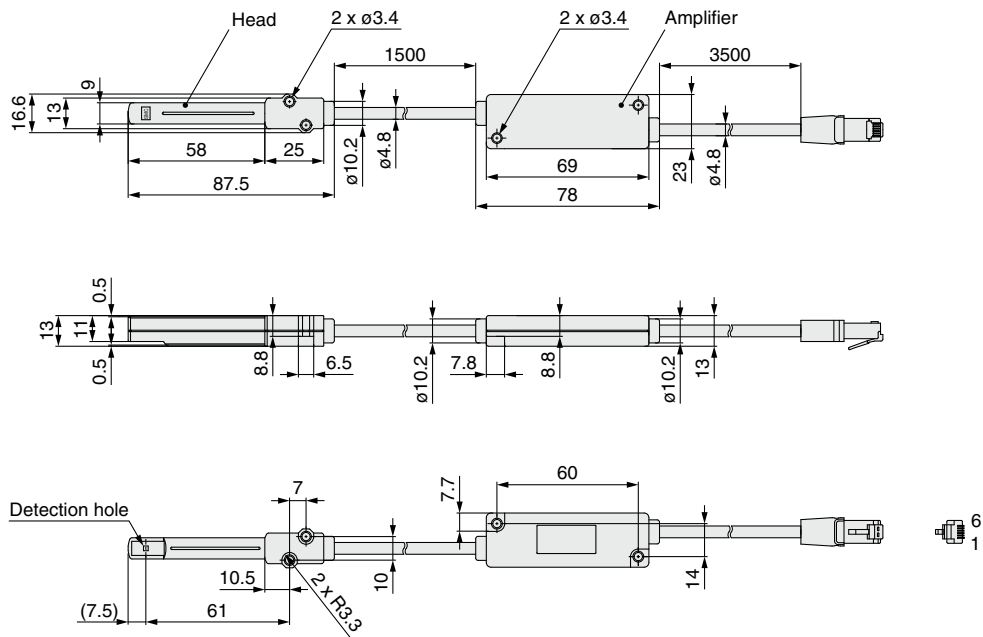

### Auto balance sensor [High accuracy type] IZS31-DG

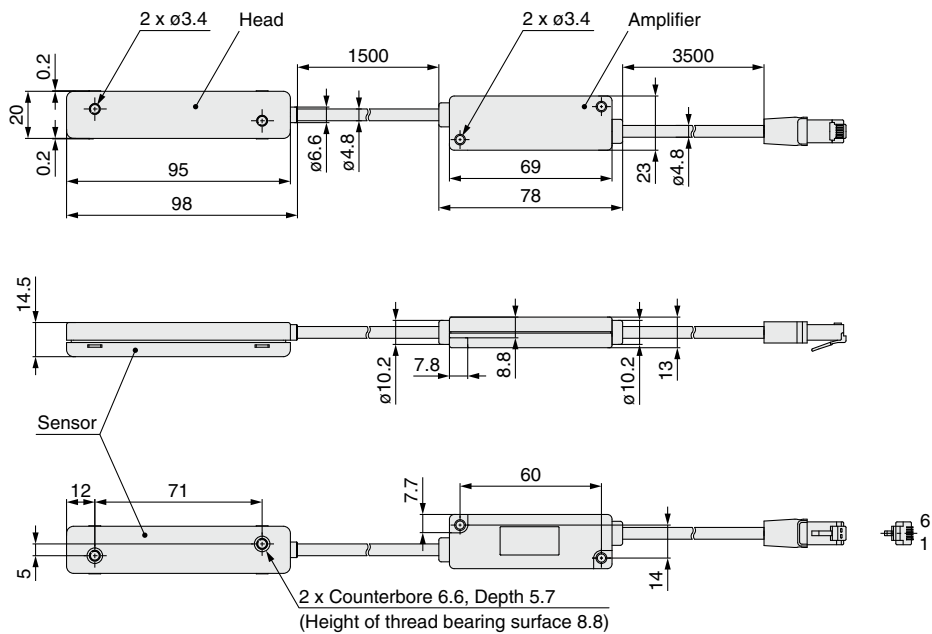

## Dimensions

### Power supply cable

#### IZS40-CP

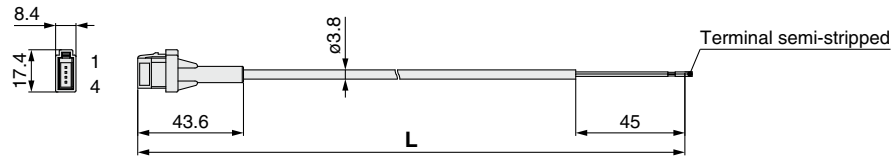

#### Cable Specifications

No. of cable wires/Size	3 cores/AWG24	
Conductor	Nominal cross section	0.2 mm <sup>2</sup>
	Outside diameter	0.66 mm
Insulator	Outside diameter	1.0 mm
Sheath	Material	Lead-free PVC
	Outside diameter	3.8 mm

#### IZS41-CP

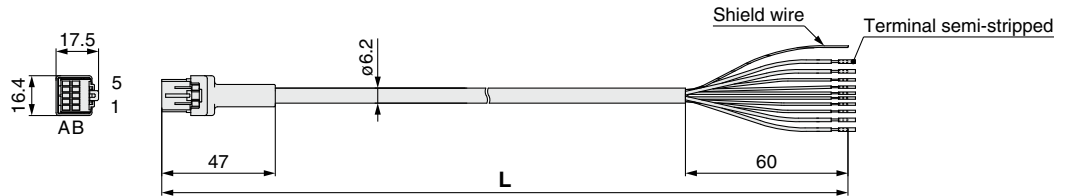

#### Cable Specifications

No. of cable wires/Size	10 cores/AWG20 (4 cores), AWG28 (6 cores)	
Conductor	Nominal cross section	0.54 mm <sup>2</sup> (4 cores), 0.09 mm <sup>2</sup> (6 cores)
	Outside diameter	0.96 mm (4 cores), 0.38 mm (6 cores)
Insulator	Outside diameter	1.4 mm Blue, Brown 0.7 mm White, Green, Light green, Purple, Gray, Yellow
	Material	Heat-resistant PVC
Sheath	Outside diameter	6.2 mm

Part no.	L [mm]
IZS40-CP	3000
IZS41-CP	
IZS40-CPZ	9800
IZS41-CPZ	

### Remote controller

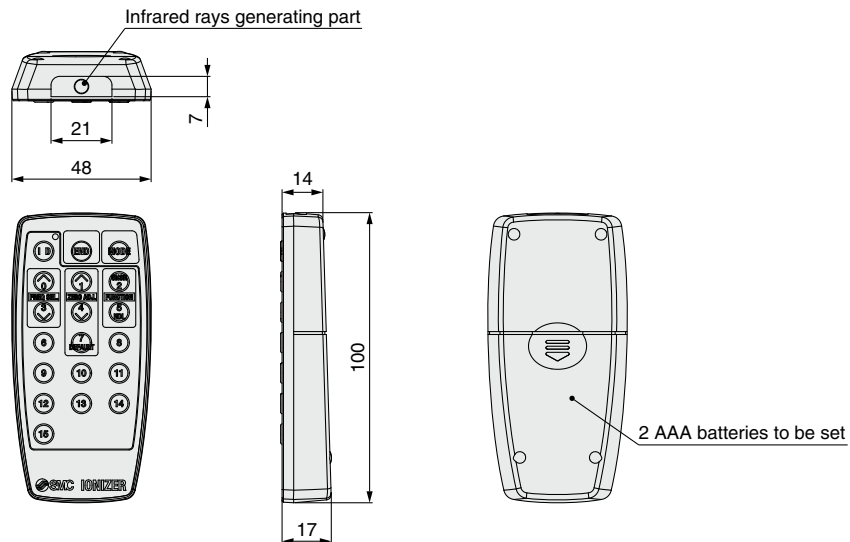

### Transition wiring cable IZS41-CF

Part no.	L [mm]
IZF41-CF02	2000
IZF41-CF05	5000
IZF41-CF08	8000

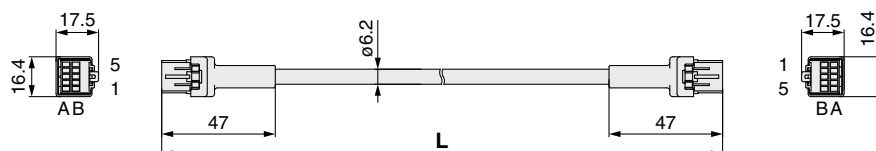



# IZS40/41/42 Series Specific Product Precautions 1

Be sure to read this before handling the products.  
Refer to the back cover for safety instructions.

## Selection

### ⚠ Caution

1. **This product is intended to be used with general factory automation (FA) equipment.**

If considering using the product for other applications (especially those stipulated on Safety Instructions), please contact SMC beforehand.

2. **Use this product within the specified voltage and temperature range.**

Using outside of the specified voltage can cause a malfunction, damage, electrical shock, or fire.

3. **Use clean compressed air as fluid. (Air quality Class 2.6.3 specified in ISO 8573-1:2010 is recommended.) This product is not explosion proof. Never use a flammable gas or an explosive gas as a fluid and never use this product in the presence of such gases.**

**Please contact us when fluids other than compressed air are used.**

This product is not explosion proof. Never use a flammable gas or an explosive gas as a fluid and never use this product in the presence of such gases. Please contact us when fluids other than compressed air are used.

4. **This product is not explosion-protected.**

Never use this product in locations where the explosion of dust is likely to occur or flammable or explosive gases are used. This can cause a fire.

### ⚠ Caution

1. **Clean specification is not available with this product.**

This product is not washed. When bringing into a clean room, flush for several minutes and confirm the required cleanliness before use. A minute amount of particles are generated due to wearing of the emitters while the ionizer is operating.

## Mounting

### ⚠ Warning

1. **Reserve enough space for maintenance, piping, and wiring.**

Please take into consideration that the One-touch fittings for supplying air, need enough space for the air tubing to be easily attached/detached.

To avoid excessive stress on the connector and One-touch fitting, please take into consideration the cable and tube minimum bending radius and avoid bending at acute angles.

Wiring with excessive twisting, bending, etc., can cause a malfunction, wire breakage or fire.

Minimum bending radius: Power supply cable: 38 mm

Transition wiring cable: 38 mm

Sensor cable: 25 mm

\* Shown above is wiring with the fixed minimum allowable bending radius and at a temperature of 20°C. If used under this temperature, the connector can receive excessive stress even though the minimum bending radius is allowable. Regarding the minimum bending radius of the tubing, refer to the operation manual or catalog for tubing.

2. **Mount this product on a plane surface.**

If there are irregularities, cracks or height differences, excessive stress will be applied to the housing or brackets, resulting in damage or other trouble. Also, do not drop or apply a strong shock. Otherwise, damage or an accident can occur.

## Mounting

### ⚠ Warning

3. **Install the product so that the entire bar does not have an excessive deflection.**

For a bar length of 820 mm or more, support the bar at both ends and in the middle by using brackets (IZS40-BM). If the bar is held only at the both ends, self-weight of the bar causes deflection, resulting in damage to the bar.

4. **Avoid using in a place where noise (electromagnetic wave surge) is generated.**

Using the ionizer under such conditions may cause it to malfunction or internal devices to deteriorate or break down. Take noise countermeasures and prevent the lines from mixing or coming into contact with each other.

5. **Use the correct tightening torque.**

If overtightened with a high torque, the mounting screws or mounting brackets may break. Also, if under tightened with a low torque, the connection may loosen. Refer to the operation manual for details.

6. **Do not touch the emitter directly with fingers or metallic tools.**

If a finger is used to touch the emitter, it may get stuck or an injury or electrical shock may occur from touching the surrounding equipment. In addition, if the emitter or cartridge is damaged with a tool, the specification will not be met and damage and/or an accident may occur.

### ⚠ Danger High Voltage

Emitters are under high voltage. Never touch them as there is a danger of electric shock or injury due to an evasive action against a momentary electrical shock caused by inserting foreign matter in the emitter cartridge or touching the emitter.

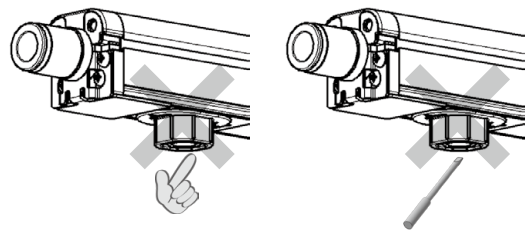

7. **Do not affix any tape or seals to the body.**

If a tape or seal contains any conductive adhesive or reflective paint, a dielectric phenomenon may occur due to the generated ions, resulting in electrostatic charge or electric leakage. Avoid using such tape and seals as it will not only cause difficulties in maintaining the performance of the product, but may also result in the failure of the product.

8. **Installation should be conducted after turning off the power supply and air supply to the body.**

### ⚠ Caution

1. **Do not install the IZS4□ series in a location where walls or structures are within the range shown in the following figure.**

If structures including walls or conductive items are located close to the unit, the generated ions will not effectively reach the object, and the specification may not be satisfied, or cause failure of the product or electric shock due to dielectricity or electric leakage. Install the product according to the dimensions shown in the following figure, keeping away from structures or conductive items.

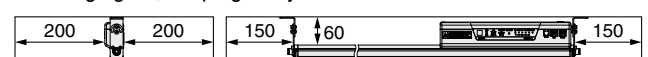

Unit: mm





# IZS40/41/42 Series Specific Product Precautions 2

Be sure to read this before handling the products.  
Refer to the back cover for safety instructions.

## Mounting

### ⚠ Caution

#### 2. Make sure to confirm the effect of static neutralization after installation.

The effects vary depending on the ambient conditions, operating conditions, etc. After installation, verify the effects of static neutralization.

#### 3. When installing the IZS41 or IZS42 in proximity with an ionizer which operates in DC mode, they should be positioned at least 2 meters away from each other.

When using the IZS41 or IZS42 near the ionizer in DC mode, keep clearance of at least 2 m between them.

The offset voltage may not be adjusted by the built-in sensor due to the ions discharged from the DC mode ionizer.

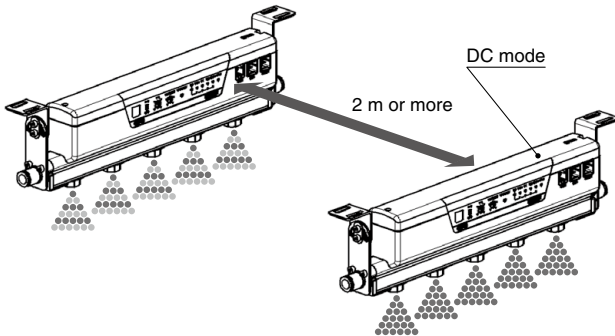

## Wiring / Piping

### ⚠ Warning

- Before wiring, ensure that the power supply capacity is enough and that the voltage is within the specification.
- To maintain product performance, the power supply shall be UL listed Class 2 certified by National Electric Code (NEC) or evaluated as a limited power source provided by UL60950.
- Ground the F.G. wire with 100 Ω or less according to the instructions in this catalog. An incomplete ground or no grounding not only prevents the performance of the product from being maintained, but may also cause failure or damage of the product, or electric shock to the human body.
- Be sure to turn off the power supply before wiring (including insertion and removal of the connector).
- To connect a feedback sensor or auto balance sensor to the ionizer, use the cable included with the sensor. Do not disassemble or modify the ionizer.
- Ensure the safety of wiring and surrounding conditions before supplying power.
- Do not connect or disconnect the connectors (including power source) while the power is supplied. Otherwise, the ionizer may malfunction.
- If the ionizer wiring and high power lines are routed together, this product may malfunction due to noise. Therefore, use a separate wiring route for this product.
- Confirm that the wiring is correct before operation. Incorrect wiring will lead to product damage or malfunction.
- Flush the piping before use. Before piping this product, exercise caution to prevent particles, water drops, or oil contents from entering the piping.

## Wiring / Piping

### ⚠ Warning

#### 11. Transition wiring of ionizer

For transition wiring of ionizers, use a transition wiring cable for connection between ionizers. Use a power supply cable for connection between ionizer and power supply or external equipment. (Transition wiring is not possible with the IZS40.) The number of ionizers that may be connected using transition wiring varies depending on the power supply cable; the length of the transition wiring cable; the use of external sensor(s) and/or models. Refer to the table shown below "Connectable number of ionizers with transition wiring."

The IZS41 and IZS42 can be connected in the same transition wiring, but mixed wiring of the NPN and PNP I/O specifications is not possible.

Please contact SMC when connecting conditions other than specified in the table below are applied.

#### Connectable number of ionizers (IZS41) with transition wiring (without external sensor)

Bar length symbol	Power supply cable length: 3 m										Power supply cable length: 10 m									
	Transition wiring cable length (same cable length) [m]										Transition wiring cable length (same cable length) [m]									
340																				
400																				
460																				
580																				
640																				
820																				
1120																				
1300																				
1600																				
1900																				
2320																				
2500																				

#### Connectable number of ionizers (IZS42) with transition wiring (without external sensor)

Bar length symbol	Power supply cable length: 3 m										Power supply cable length: 10 m									
	Transition wiring cable length (same cable length) [m]										Transition wiring cable length (same cable length) [m]									
340																				
400																				
460																				
580																				
640																				
820																				
1120																				
1300																				
1600																				
1900																				
2320																				
2500																				

It is recommended that the power supply used to operate the ionizers have a current capacity twice that of the total current consumption of the ionizers to be used. Power supply voltage should be from 24 to 26.4 VDC.

AC adapter must not be used when ionizer is used in a transition wiring. When ionizers are connected with transition wiring, the same input signal serves as input to all the ionizers. When a signal is output from at least one ionizer in the connection, the signal will be output from the power supply cable.

Connect the power supply cable to the "POWER" connector of the 1st ionizer, and connect the "LINK" connector of the 1st ionizer to the "POWER" connector of the 2nd ionizer with a transition wiring cable. Follow the same procedure to connect subsequent ionizer(s) and after with transition wiring cables.

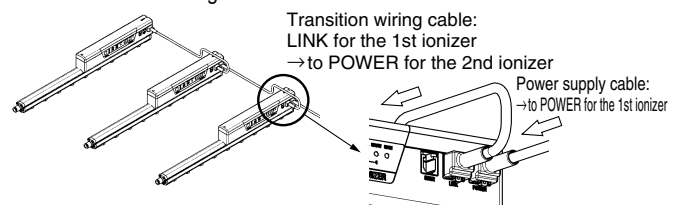



# IZS40/41/42 Series

## Specific Product Precautions 3

Be sure to read this before handling the products.  
Refer to the back cover for safety instructions.

### Operating Environment / Storage Environment

#### Warning

##### 1. Observe the fluid temperature and ambient temperature range.

Fluid temperature and ambient temperature ranges are; 0 to 40°C for ionizer, 0 to 50°C for feedback sensor and auto balance sensor (high accuracy type), 0 to 40°C for AC adapter, and 0 to 45°C for remote controller. Do not use the product in locations where the temperature may change suddenly even if the ambient temperature range is within the specified limits, resulting in condensation.

##### 2. Do not use this product in an enclosed space.

This product utilizes a corona discharge phenomenon. Do not use the product in an enclosed space as ozone and nitrogen oxides exist in such places, even though in marginal quantities.

##### 3. Environments to avoid

Never use or store under the following conditions. These may cause a failure.

- Where the ambient temperature exceeds the operating temperature range
- Where the ambient humidity exceeds the operating humidity range
- Areas where abrupt temperature changes may cause condensation
- Areas where corrosive gas, flammable gas or other volatile flammable substances are stored
- Areas where the product may be exposed to conductive powder such as iron powder or dust, oil mist, salt, organic solvent, machining chips, particles or cutting oil (including water and any liquids), etc.
- Paths of direct air flow, such as air conditioners
- Enclosed or poorly ventilated areas
- Locations that are exposed to direct sunlight or heat radiation
- Areas where strong electromagnetic noise is generated, such as strong electrical and magnetic fields or supply voltage spikes
- Areas where the product is exposed to static electricity discharge
- Locations where strong high frequency is generated
- Locations that are subject to potential lightning strikes
- Areas where the product may receive direct impact or vibration
- Areas where the product may be subjected to forces or weight that could cause physical deformation

##### 4. Do not use an air containing mist or dust.

The air containing mist or dust will cause the performance to decrease and shorten the maintenance cycle.

Install a dryer (IDF series), air filter (AF/AFF series), and/or mist separator (AFM/AM series) to obtain clean compressed air (air quality of Class 2.6.3 or higher according to ISO 8573-1:2010 is recommended for operation).

##### 5. Ionizer, feedback sensor, auto balance sensor, remote controller, and AC adapter are not resistant to lightning surge.

##### 6. Effects on implantable medical devices

The electromagnetic waves emitted from this product may interfere with implantable medical devices such as cardiac pacemakers and cardioverter defibrillators, resulting in the malfunction of the medical device or other adverse effects.

Please use extreme caution when operating equipment which may have an adverse effect on your implantable medical device. Be sure to thoroughly read the precautions stated in the catalog, operation manual, etc., of your implantable medical device, or contact the manufacturer directly for further details on what types of equipment need to be avoided.

### Maintenance

#### Warning

##### 1. Periodically inspect the ionizer and clean the emitters.

Check regularly if the product is operating with undetected failures or not. The maintenance must be performed by an operator who has sufficient knowledge and experience. If particles attach to the emitter by using for long periods of time, the static neutralizing performance will be lowered.

Replace the emitter cartridge, if the emitters are worn and the static neutralizing performance does not return even after being cleaned.

#### Danger High Voltage

This product contains a high voltage generation circuit. When performing maintenance inspection, be sure to confirm that the power supply to the ionizer is turned off. Never disassemble or modify the ionizer, as this may not only impair the product's functionality but could cause an electric shock or electric leakage.

##### 2. When cleaning the emitter or replacing the emitter cartridge, be sure to turn off the power supply or air supply to the body.

If the emitters are touched while the product is energized, this may cause an electric shock or accident.

If an attempt to replace the emitter cartridges is performed before removing air supply, the emitter cartridges may eject unexpectedly due to presence of the supply air. Remove air supply before replacing the cartridges. If emitter cartridges are not securely mounted to the bar, they may eject or release when air is supplied to the product. Securely mount or remove the emitter cartridges referencing the instructions shown below.

#### Removal of emitter cartridge

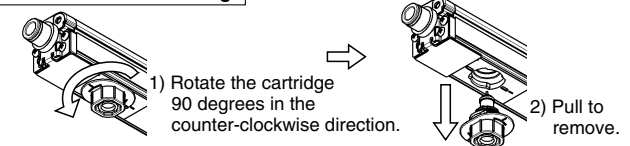

#### Mounting of emitter cartridge

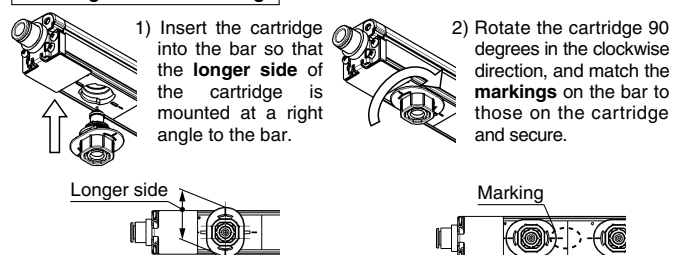

##### 3. Perform the detection procedure in the absence of workpieces. (IZS41, 42)

##### 4. Do not disassemble or modify the product.

Otherwise, an electrical shock, damage and/or a fire may occur. Also, the disassembled or modified products may not achieve the performances guaranteed in the specifications, and exercise caution because the product will not be warranted.

##### 5. Do not operate the product with wet hands.

Otherwise, an electrical shock or accident may occur.



## IZS40/41/42 Series

# Specific Product Precautions 4

Be sure to read this before handling the products.  
Refer to the back cover for safety instructions.

### Handling

#### **Caution**

- 1. Do not drop, bump or apply excessive impact (100 m/s<sup>2</sup> or more) while handling.**

Even though it does not appear to be damaged, the internal parts may be damaged and cause a malfunction.

- 2. When installing the product, handle the product so that no moment is applied to the controller and the ends of the bar.**

Handling the product by holding either end of the bar may cause damage to the product.

- 3. When mounting/dismounting the cable, use your finger to pinch the claw of the plug, then attach/detach it correctly.**

If the modular plug is at a difficult angle to attach/detach, the jack's mounting section may be damaged and cause a disorder.

## Safety Instructions

These safety instructions are intended to prevent hazardous situations and/or equipment damage. These instructions indicate the level of potential hazard with the labels of “**Caution**,” “**Warning**” or “**Danger**.” They are all important notes for safety and must be followed in addition to International Standards (ISO/IEC)\*1), and other safety regulations.

 **Caution:** **Caution** indicates a hazard with a low level of risk which, if not avoided, could result in minor or moderate injury.

 **Warning:** **Warning** indicates a hazard with a medium level of risk which, if not avoided, could result in death or serious injury.

 **Danger :** **Danger** indicates a hazard with a high level of risk which, if not avoided, will result in death or serious injury.

\*1) ISO 4414: Pneumatic fluid power – General rules relating to systems.  
ISO 4413: Hydraulic fluid power – General rules relating to systems.  
IEC 60204-1: Safety of machinery – Electrical equipment of machines.  
(Part 1: General requirements)  
ISO 10218-1: Manipulating industrial robots – Safety.  
etc.

### Warning

#### 1. The compatibility of the product is the responsibility of the person who designs the equipment or decides its specifications.

Since the product specified here is used under various operating conditions, its compatibility with specific equipment must be decided by the person who designs the equipment or decides its specifications based on necessary analysis and test results. The expected performance and safety assurance of the equipment will be the responsibility of the person who has determined its compatibility with the product. This person should also continuously review all specifications of the product referring to its latest catalog information, with a view to giving due consideration to any possibility of equipment failure when configuring the equipment.

#### 2. Only personnel with appropriate training should operate machinery and equipment.

The product specified here may become unsafe if handled incorrectly. The assembly, operation and maintenance of machines or equipment including our products must be performed by an operator who is appropriately trained and experienced.

#### 3. Do not service or attempt to remove product and machinery/equipment until safety is confirmed.

1. The inspection and maintenance of machinery/equipment should only be performed after measures to prevent falling or runaway of the driven objects have been confirmed.
2. When the product is to be removed, confirm that the safety measures as mentioned above are implemented and the power from any appropriate source is cut, and read and understand the specific product precautions of all relevant products carefully.
3. Before machinery/equipment is restarted, take measures to prevent unexpected operation and malfunction.

#### 4. Contact SMC beforehand and take special consideration of safety measures if the product is to be used in any of the following conditions.

1. Conditions and environments outside of the given specifications, or use outdoors or in a place exposed to direct sunlight.
2. Installation on equipment in conjunction with atomic energy, railways, air navigation, space, shipping, vehicles, military, medical treatment, combustion and recreation, or equipment in contact with food and beverages, emergency stop circuits, clutch and brake circuits in press applications, safety equipment or other applications unsuitable for the standard specifications described in the product catalog.
3. An application which could have negative effects on people, property, or animals requiring special safety analysis.
4. Use in an interlock circuit, which requires the provision of double interlock for possible failure by using a mechanical protective function, and periodical checks to confirm proper operation.

### Caution

#### 1. The product is provided for use in manufacturing industries.

The product herein described is basically provided for peaceful use in manufacturing industries.  
If considering using the product in other industries, consult SMC beforehand and exchange specifications or a contract if necessary.  
If anything is unclear, contact your nearest sales branch.

### Limited warranty and Disclaimer/ Compliance Requirements

The product used is subject to the following “Limited warranty and Disclaimer” and “Compliance Requirements”.

Read and accept them before using the product.

#### Limited warranty and Disclaimer

1. The warranty period of the product is 1 year in service or 1.5 years after the product is delivered, whichever is first.\*2)  
Also, the product may have specified durability, running distance or replacement parts. Please consult your nearest sales branch.
2. For any failure or damage reported within the warranty period which is clearly our responsibility, a replacement product or necessary parts will be provided.  
This limited warranty applies only to our product independently, and not to any other damage incurred due to the failure of the product.
3. Prior to using SMC products, please read and understand the warranty terms and disclaimers noted in the specified catalog for the particular products.

##### \*2) Vacuum pads are excluded from this 1 year warranty.

A vacuum pad is a consumable part, so it is warranted for a year after it is delivered.  
Also, even within the warranty period, the wear of a product due to the use of the vacuum pad or failure due to the deterioration of rubber material are not covered by the limited warranty.

#### Compliance Requirements

1. The use of SMC products with production equipment for the manufacture of weapons of mass destruction (WMD) or any other weapon is strictly prohibited.
2. The exports of SMC products or technology from one country to another are governed by the relevant security laws and regulations of the countries involved in the transaction. Prior to the shipment of a SMC product to another country, assure that all local rules governing that export are known and followed.

### Caution

#### SMC products are not intended for use as instruments for legal metrology.

Measurement instruments that SMC manufactures or sells have not been qualified by type approval tests relevant to the metrology (measurement) laws of each country. Therefore, SMC products cannot be used for business or certification ordained by the metrology (measurement) laws of each country.

#### Revision History

**Edition B** \* Excerpted from pages 1097 to 1124 of the Best Pneumatics No. 6 (Ver. 5). RZ

**Edition C** \* The energy saving high-efficiency cartridge has been added.

\* The contents of the technical data have been revised.

\* Information on the effects on implantable medical devices has been added to the specific product precautions.

YQ

## Safety Instructions

Be sure to read the “Handling Precautions for SMC Products” (M-E03-3) and “Operation Manual” before use.