

Compact Cylinder

ø12, ø16, ø20, ø25, ø32, ø40, ø50, ø63, ø80, ø100

RoHS

Compact

- Both ends tapped mounting added.
- Bore sizes ø80, ø100 added.
- Port thread types NPT, G added.

Overall length shortened

Width shortened

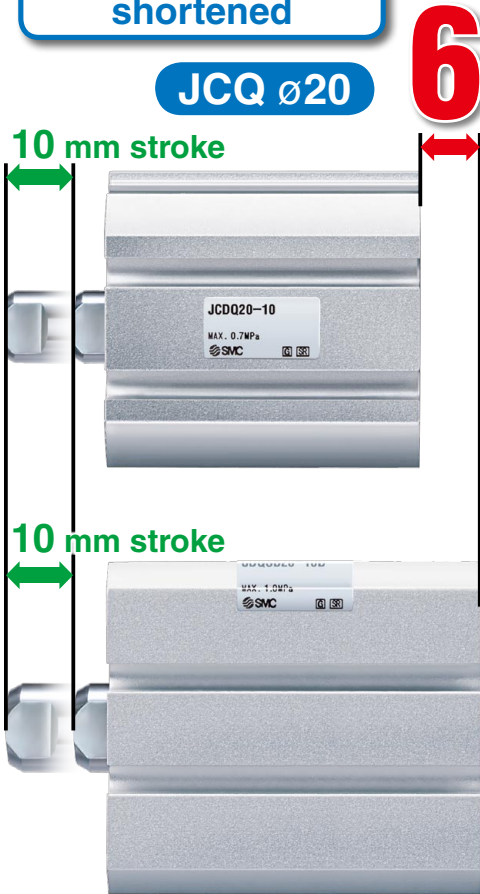

Current product ø20 (CDQS series)

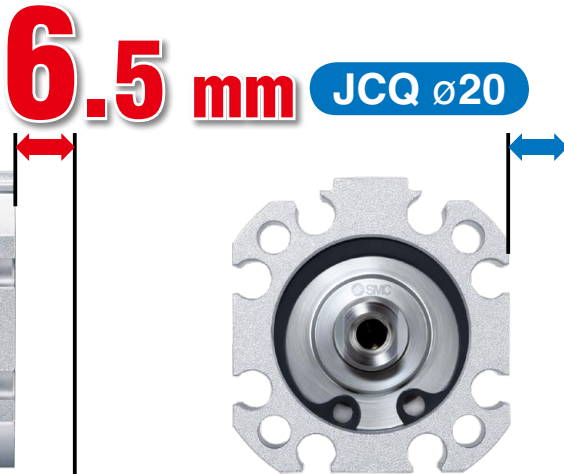

Current product ø20 (CDQS series)

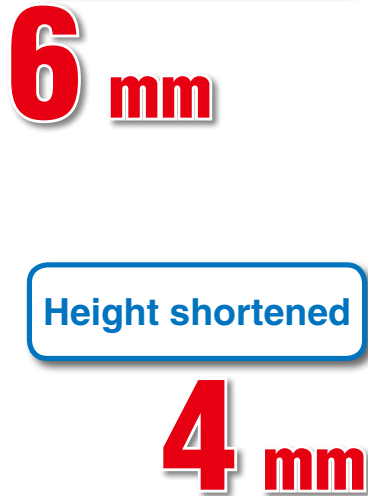

JCQ ø20

Height shortened

Max. **Weight 45% lighter**

150 g → 82 g
(Compared with the current CDQS series, ø25, 10 mm stroke)



JCQ Series

Compact

(Compared with the current product) [mm]

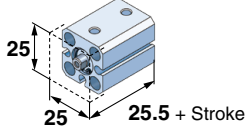
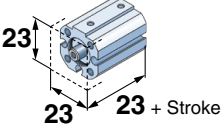
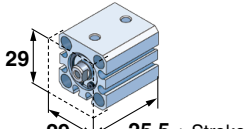
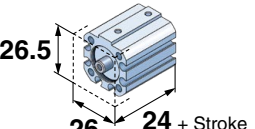
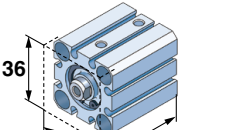
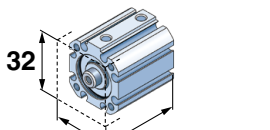
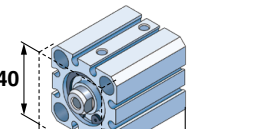
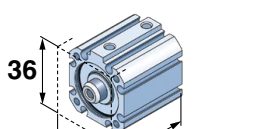
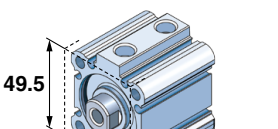
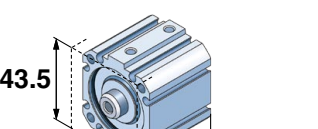
Bore size	CDQS	JCDQ
∅12	Weight 43 g  25 x 25 x 25.5 + Stroke	Weight 29 g  23 x 23 x 23 + Stroke 33% weight reduction 24% volume reduction
∅16	Weight 57 g  29 x 29 x 25.5 + Stroke	Weight 37 g  26.5 x 26 x 24 + Stroke 35% weight reduction 23% volume reduction
∅20	Weight 106 g  36 x 36 x 34 + Stroke	Weight 61 g  32 x 30 x 27.5 + Stroke 42% weight reduction 40% volume reduction
∅25	Weight 150 g  40 x 40 x 37.5 + Stroke	Weight 82 g  36 x 33.5 x 30 + Stroke 45% weight reduction 40% volume reduction
∅32 ^{*1}	Weight 202 g  49.5 x 45 x 40 + Stroke	Weight 135 g  43.5 x 41 x 32.5 + Stroke 33% weight reduction 35% volume reduction

Bore size [mm]	Weight		Reduction rate %	
	CDQ2	JCDQ	Weight	Volume
∅40	290 g	201 g	31%	35%
∅50	455 g	332 g	27%	28%
∅63	627 g	513 g	18%	29%
∅80	1162 g	961 g	17%	26%
∅100	1966 g	1490 g	24%	26%

*1 For the CDQ2 series
 *2 Weight comparison is at 10 mm stroke.
 *3 For built-in magnet cylinders



Compact Cylinder

Double Acting, Single Rod

JCQ Series

ø12, ø16, ø20, ø25, ø32, ø40, ø50, ø63, ø80, ø100



RoHS

How to Order

Without auto switch **JCQ** [] [] [] - **30** - []

With auto switch **JCDQ** [] [] [] - **30** - **L** - **M9BW** []

With magnet for auto switch

Mounting

Nil	Through-hole (Standard)
A	Both ends tapped

Bore size

12	12 mm
16	16 mm
20	20 mm
25	25 mm
32	32 mm
40	40 mm
50	50 mm
63	63 mm
80	80 mm
100	100 mm

Port thread type

Nil	M thread	ø12 to ø40
	Rc	
TN	NPT	ø50 to ø100
TF	G	

Number of auto switches

Nil	2
S	1
n	n

Auto switch

Nil	Without auto switch
-----	---------------------

* For applicable auto switches, refer to the table below.

Mounting bolt

Nil	None
L	Shipped together

* Mounting bolt is shipped together only when the mounting symbol is Nil (through-hole).
* For details about the mounting bolt sizes, refer to page 4-1.
* Mounting bolt is shipped together.

Cylinder stroke [mm]
Refer to "Standard Strokes" on page 3.

Applicable Auto Switches/Refer to the WEB catalog or Best Pneumatics for further information on auto switches.

Type	Special function	Electrical entry	Indicator/light	Wiring (Output)	Load voltage		Auto switch model		Lead wire length [m]					Pre-wired connector	Applicable load		
					DC	AC	Perpendicular	In-line	0.5 (Nil)	1 (M)	3 (L)	5 (Z)	None (N)		Relay, PLC	IC circuit	
Solid state auto switch	—	Grommet	Yes	3-wire (NPN)	24 V	5 V, 12 V	—	M9NV	M9N	●	●	●	○	—			○
				3-wire (PNP)				M9PV	M9P	●	●	●	○	—	○		
				2-wire				M9BV	M9B	●	●	●	○	—	○		
	3-wire (NPN)			M9NWV				M9NW	●	●	●	○	—	○	IC circuit		
	3-wire (PNP)			M9PWV				M9PW	●	●	●	○	—	○			
	2-wire			M9B WV				M9B W	●	●	●	○	—	○	—		
	3-wire (NPN)			M9NAV**				M9NA**	○	○	●	○	—	○	IC circuit		
	3-wire (PNP)			M9PAV**				M9PA**	○	○	●	○	—	○			
	2-wire			M9BAV**				M9BA**	○	○	●	○	—	○	—		

** Water resistant type auto switches can be mounted on the above models, but in such case SMC cannot guarantee water resistance. Please contact SMC regarding water resistant types with the above model numbers.

* Lead wire length symbols: 0.5 m.....Nil (Example) M9NW * Solid state auto switches marked with "○" are produced upon receipt of order.
1 m.....M (Example) M9NWM
3 m.....L (Example) M9NWL
5 m.....Z (Example) M9NWZ

* For details about auto switches with pre-wired connector, refer to the WEB catalog or Best Pneumatics.

* Auto switches are shipped together, (but not assembled).

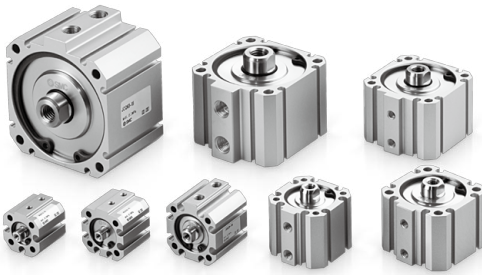

Symbol

Rubber bumper

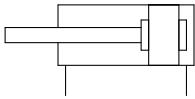

Specifications

Bore size [mm]	12	16	20	25	32	40	50	63	80	100
Action	Double acting, Single rod									
Fluid	Air									
Proof pressure	1.0 MPa									
Maximum operating pressure	0.7 MPa *1									
Minimum operating pressure	0.07 MPa					0.05 MPa				
Ambient and fluid temperature	5 to 60°C									
Lubrication	Not required (Non-lube)									
Piston speed*	50 to 500 mm/s *1					50 to 300 mm/s *1				
Cushion	Rubber bumper									
Allowable kinetic energy [J]	0.022	0.038	0.055	0.09	0.15	0.26	0.46	0.77	1.36	2.27
Rod end thread	Female thread									
Stroke length tolerance	+1.3 0 mm ^{Note)}									

Note) Stroke length tolerance does not include the deflection of the bumper.

* Depending on the system configuration selected, the specified speed may not be satisfied.

*1 Maximum operating pressure and piston speed are different from the current product (CQ2 series).

Standard Strokes

Note) When using with auto switches, refer to the Minimum Stroke for Auto Switch Mounting table on page 8.

Bore size [mm]	Standard stroke [mm]
12, 16	5, 10, 15, 20, 25, 30
20, 25, 32, 40	5, 10, 15, 20, 25, 30, 35, 40, 45, 50
50, 63, 80, 100	10, 15, 20, 25, 30, 35, 40, 45, 50

* Intermediate strokes are available as a special order.

Theoretical Output

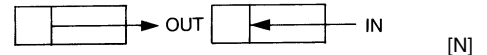

Refer to page 8 for cylinders with auto switches.

- Auto switch proper mounting position (detection at stroke end) and mounting height
- Minimum stroke for auto switch mounting
- Operating range
- Auto switch mounting

Bore size [mm]	Rod size [mm]	Operating direction	Piston area [mm ²]	Operating pressure [MPa]					
				0.2	0.3	0.4	0.5	0.6	0.7
12	6	OUT	113	23	34	45	57	68	79
		IN	85	17	25	34	42	51	59
16	6	OUT	201	40	60	80	101	121	141
		IN	173	35	52	69	86	104	121
20	8	OUT	314	63	94	126	157	188	220
		IN	264	53	79	106	132	158	185
25	10	OUT	491	98	147	196	245	295	344
		IN	412	82	124	165	206	247	289
32	12	OUT	804	161	241	322	402	483	563
		IN	691	138	207	276	346	415	484
40	14	OUT	1257	251	377	503	628	754	880
		IN	1103	221	331	441	551	662	772
50	18	OUT	1963	393	589	785	982	1178	1374
		IN	1709	342	513	684	855	1025	1196
63	18	OUT	3117	623	935	1247	1559	1870	2182
		IN	2863	573	859	1145	1431	1718	2004
80	22	OUT	5027	1005	1508	2011	2513	3016	3519
		IN	4646	929	1394	1859	2323	2788	3252
100	26	OUT	7854	1571	2356	3142	3927	4712	5498
		IN	7323	1465	2197	2929	3662	4394	5126

Allowable Kinetic Energy

Load Mass and Piston Speed [J]

Bore size [mm]	12	16	20	25	32	40	50	63
Standard/ Allowable kinetic energy: E _a	0.022	0.038	0.055	0.09	0.15	0.26	0.46	0.77

$$\text{Kinetic energy } E \text{ [J]} = \frac{(m_1 + m_2) V^2}{2}$$

m₁: Mass of cylinder moving parts kg

m₂: Load mass kg

V: Piston speed m/s

Mass of Cylinder Moving Parts:

Without Magnet for Auto Switch [g]

Bore size [mm]	Cylinder stroke [mm]									
	5	10	15	20	25	30	35	40	45	50
12	5	6	7	8	9	10	—	—	—	—
16	5	6	7	9	10	11	—	—	—	—
20	9	11	13	15	17	19	21	23	25	27
25	15	18	21	24	27	30	33	37	40	43
32	27	32	36	41	45	50	54	59	63	67
40	42	48	54	60	66	73	79	85	91	97
50	—	91	101	111	121	131	141	151	161	171
63	—	130	140	150	159	169	179	189	199	209
80	—	240	255	270	285	300	315	329	344	359
100	—	426	446	467	488	509	530	551	572	592

Mass of Cylinder Moving Parts:

With Magnet for Auto Switch [g]

Bore size [mm]	Cylinder stroke [mm]									
	5	10	15	20	25	30	35	40	45	50
12	6	7	8	9	10	11	—	—	—	—
16	7	8	9	10	11	12	—	—	—	—
20	16	17	19	21	23	25	27	29	31	33
25	25	28	31	34	37	40	43	46	49	53
32	43	48	52	57	61	66	70	75	79	83
40	69	75	81	87	93	99	105	111	117	123
50	—	127	137	147	157	167	177	187	197	207
63	—	180	190	200	210	220	230	240	250	260
80	—	329	344	359	374	389	404	419	433	448
100	—	545	565	586	607	628	649	670	690	711

Weight

Without Magnet for Auto Switch [g]

Bore size [mm]	Cylinder stroke [mm]									
	5	10	15	20	25	30	35	40	45	50
12	21	25	30	35	39	44	—	—	—	—
16	28	33	38	43	49	54	—	—	—	—
20	40	47	55	62	69	77	84	91	99	106
25	55	64	73	83	92	101	110	119	128	138
32	94	108	121	135	148	162	175	189	202	215
40	145	161	177	194	210	226	243	259	275	292
50	—	284	309	334	359	384	410	435	460	485
63	—	452	483	514	545	576	606	637	668	699
80	—	850	899	948	997	1046	1095	1144	1193	1242
100	—	1348	1407	1465	1524	1582	1641	1700	1758	1817

Allowable Lateral Load at Rod End

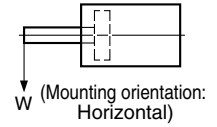

Without Magnet for Auto Switch

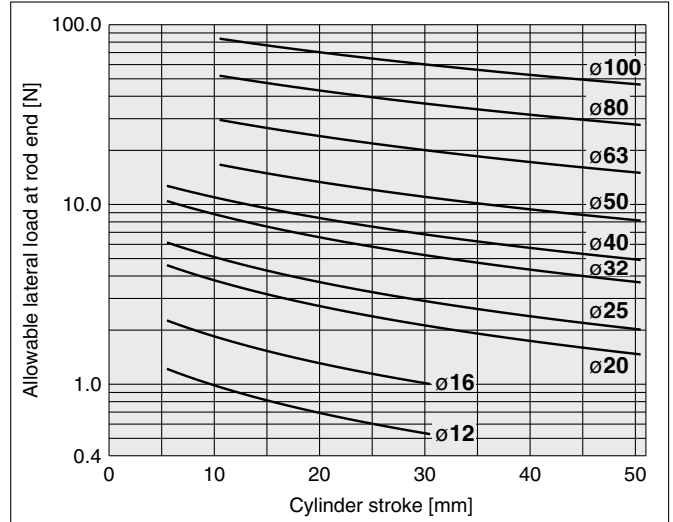

With Magnet for Auto Switch

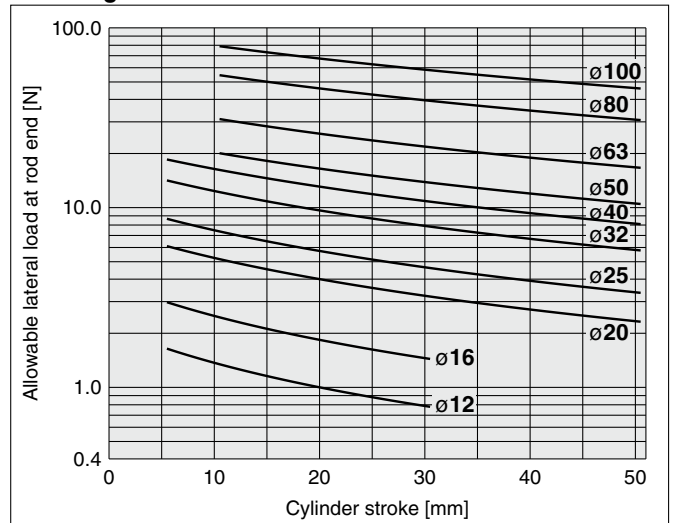

With Magnet for Auto Switch [g]

Bore size [mm]	Cylinder stroke [mm]									
	5	10	15	20	25	30	35	40	45	50
12	25	29	34	38	43	48	—	—	—	—
16	32	37	43	48	53	58	—	—	—	—
20	53	61	68	75	83	90	98	105	112	120
25	73	82	91	100	109	119	128	137	146	155
32	122	135	149	162	176	189	203	216	230	243
40	184	201	217	233	250	266	282	299	315	331
50	—	332	357	383	408	433	458	483	508	533
63	—	513	544	575	606	637	667	698	729	760
80	—	961	1010	1059	1109	1158	1207	1256	1305	1354
100	—	1490	1549	1608	1666	1725	1783	1842	1901	1959

Mounting Bolt for JCQ

Mounting method: Through-hole type mounting bolts are available. Refer to the following for ordering procedures. Order the actual number of bolts that will be used.

Example) CQ-M3 x 25L 4 pcs.

Material: Chromium molybdenum steel
Surface treatment: Zinc chromated

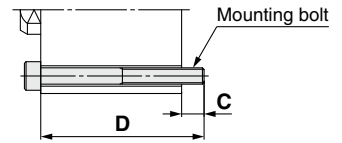

Without Magnet for Auto Switch

Cylinder model	C	D	Mounting bolt part no.
JCQ12-5	4	25	CQ-M3 x 25L
-10		30	x 30L
-15		35	x 35L
-20		40	x 40L
-25		45	x 45L
-30		50	x 50L
JCQ16-5	8	30	CQ-M3 x 30L
-10		35	x 35L
-15		40	x 40L
-20		45	x 45L
-25		50	x 50L
-30		55	x 55L
JCQ20-5	7.5	30	CQ-M3 x 30L
-10		35	x 35L
-15		40	x 40L
-20		45	x 45L
-25		50	x 50L
-30		55	x 55L
-35		60	x 60L
-40		65	x 65L
-45		70	x 70L
-50		75	x 75L
JCQ25-5	6	30	CQ-M3 x 30L
-10		35	x 35L
-15		40	x 40L
-20		45	x 45L
-25		50	x 50L
-30		55	x 55L
-35		60	x 60L
-40		65	x 65L
-45		70	x 70L
-50		75	x 75L

Cylinder model	C	D	Mounting bolt part no.
JCQ32-5	9	35	CQ-M4 x 35L
-10		40	x 40L
-15		45	x 45L
-20		50	x 50L
-25		55	x 55L
-30		60	x 60L
-35		65	x 65L
-40		70	x 70L
-45		75	x 75L
-50		80	x 80L
JCQ40-5	10	40	CQ-M4 x 40L
-10		45	x 45L
-15		50	x 50L
-20		55	x 55L
-25		60	x 60L
-30		65	x 65L
-35		70	x 70L
-40		75	x 75L
-45		80	x 80L
-50		85	x 85L
JCQ50-10	11	50	CQ-M5 x 50L
-15		55	x 55L
-20		60	x 60L
-25		65	x 65L
-30		70	x 70L
-35		75	x 75L
-40		80	x 80L
-45		85	x 85L
-50		90	x 90L

Cylinder model	C	D	Mounting bolt part no.
JCQ63-10	11.5	55	CQ-M5 x 55L
-15		60	x 60L
-20		65	x 65L
-25		70	x 70L
-30		75	x 75L
-35		80	x 80L
-40		85	x 85L
-45		90	x 90L
-50		95	x 95L
JCQ80-10		15	65
-15	70		x 70L
-20	75		x 75L
-25	80		x 80L
-30	85		x 85L
-35	90		x 90L
-40	95		x 95L
-45	100		x 100L
-50	105		x 105L
JCQ100-10	14		70
-15		75	x 75L
-20		80	x 80L
-25		85	x 85L
-30		90	x 90L
-35		95	x 95L
-40		100	x 100L
-45		105	x 105L
-50		110	x 110L

With Magnet for Auto Switch

Cylinder model	C	D	Mounting bolt part no.
JCDQ12-5	5.5	30	CQ-M3 x 30L
-10		35	x 35L
-15		40	x 40L
-20		45	x 45L
-25		50	x 50L
-30		55	x 55L
JCDQ16-5	9.5	35	CQ-M3 x 35L
-10		40	x 40L
-15		45	x 45L
-20		50	x 50L
-25		55	x 55L
-30		60	x 60L
JCDQ20-5	6	35	CQ-M3 x 35L
-10		40	x 40L
-15		45	x 45L
-20		50	x 50L
-25		55	x 55L
-30		60	x 60L
-35		65	x 65L
-40		70	x 70L
-45		75	x 75L
-50		80	x 80L
JCDQ25-5	4.5	35	CQ-M3 x 35L
-10		40	x 40L
-15		45	x 45L
-20		50	x 50L
-25		55	x 55L
-30		60	x 60L
-35		65	x 65L
-40		70	x 70L
-45		75	x 75L
-50		80	x 80L

Cylinder model	C	D	Mounting bolt part no.
JCDQ32-5	7.5	40	CQ-M4 x 40L
-10		45	x 45L
-15		50	x 50L
-20		55	x 55L
-25		60	x 60L
-30		65	x 65L
-35		70	x 70L
-40		75	x 75L
-45		80	x 80L
-50		85	x 85L
JCDQ40-5	8.5	45	CQ-M4 x 45L
-10		50	x 50L
-15		55	x 55L
-20		60	x 60L
-25		65	x 65L
-30		70	x 70L
-35		75	x 75L
-40		80	x 80L
-45		85	x 85L
-50		90	x 90L
JCDQ50-10	10.5	55	CQ-M5 x 55L
-15		60	x 60L
-20		65	x 65L
-25		70	x 70L
-30		75	x 75L
-35		80	x 80L
-40		85	x 85L
-45		90	x 90L
-50		95	x 95L

Cylinder model	C	D	Mounting bolt part no.
JCDQ63-10	11.5	60	CQ-M5 x 60L
-15		65	x 65L
-20		70	x 70L
-25		75	x 75L
-30		80	x 80L
-35		85	x 85L
-40		90	x 90L
-45		95	x 95L
-50		100	x 100L
JCDQ80-10		14	70
-15	75		x 75L
-20	80		x 80L
-25	85		x 85L
-30	90		x 90L
-35	95		x 95L
-40	100		x 100L
-45	105		x 105L
-50	110		x 110L
JCDQ100-10	13		75
-15		80	x 80L
-20		85	x 85L
-25		90	x 90L
-30		95	x 95L
-35		100	x 100L
-40		105	x 105L
-45		110	x 110L
-50		115	x 115L

JCQ Series

Bore Size

∅12, ∅16

Standard (Through-hole): JCQ, JCDQ

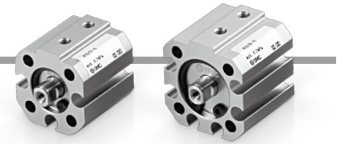

∅12

Both ends tapped: JCQA, JCDQA

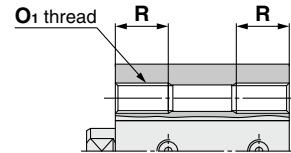

Both Ends Tapped [mm]

Bore size	O1	R
12	M4 x 0.7	7
16	M4 x 0.7	7

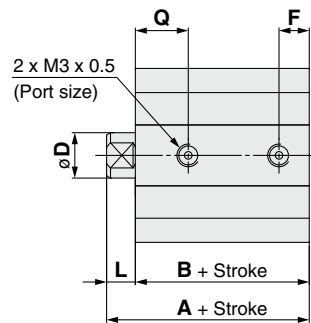
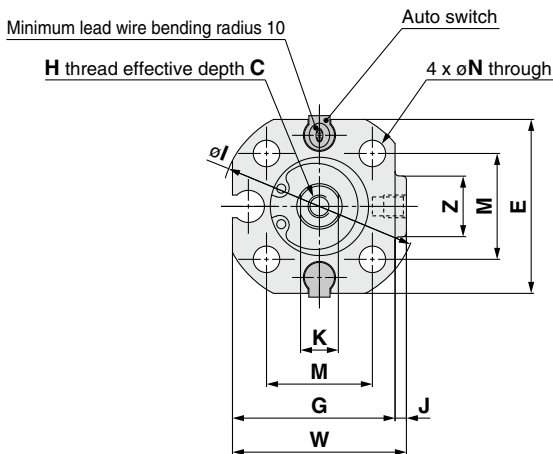

∅16

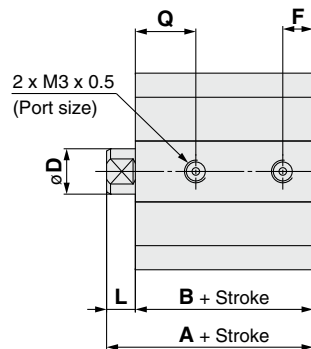
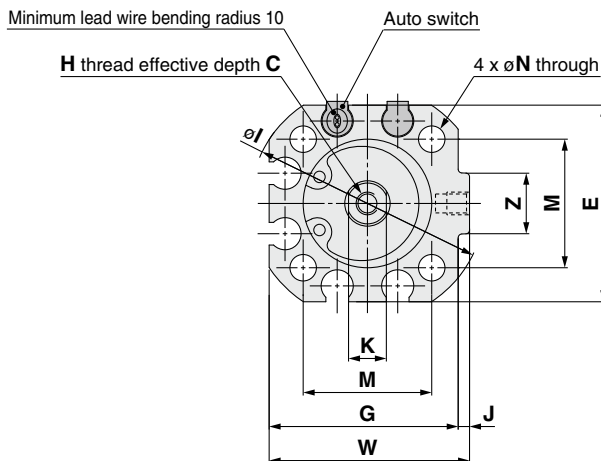

Standard

[mm]

Bore size	Stroke range	Without magnet for auto switch		With magnet for auto switch		C	D	E	F	G	H	I	J	K	L	M	N	Q	W	Z
		A	B	A	B															
12	5 to 30	19.5	16	23	19.5	6	6	23	4	21.5	M3 x 0.5	26	1.5	5	3.5	14	3.5	7	23	8
16	5 to 30	20.5	17	24	20.5	6	6	26	4	25	M3 x 0.5	31	1.5	5	3.5	17	3.5	8	26.5	8

Bore Size

ø20 to ø40

Standard (Through-hole): JCQ, JCDQ

ø20

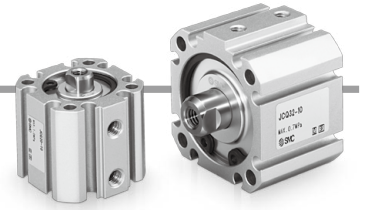

Both ends tapped: JCQA, JCDQA

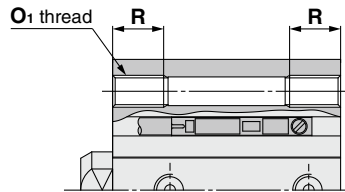

Both Ends Tapped [mm]

Bore size	O ₁	R
20	M4 x 0.7	7
25	M4 x 0.7	7
32	M5 x 0.8	8
40	M5 x 0.8	8

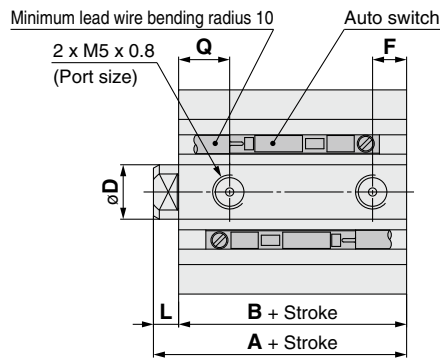
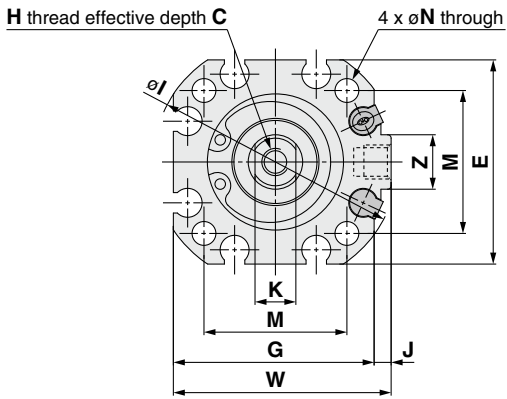

ø25 to ø40

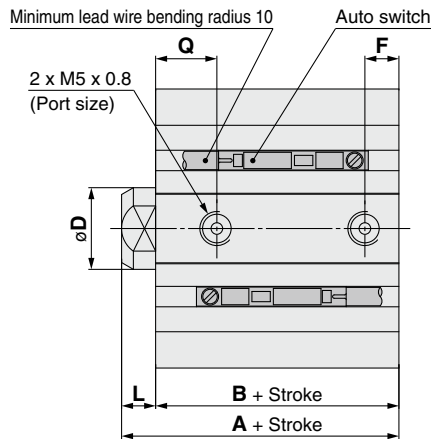
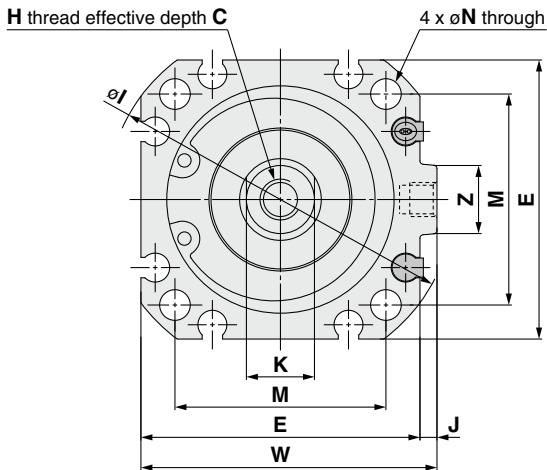

Standard

Bore size	Stroke range	Without magnet for auto switch		With magnet for auto switch		C	D	E	F	G	H	I	J	K	L	M	N	Q	W	Z
		A	B	A	B															
20	5 to 50	21	17.5	27.5	24	8	8	30	5	29.5	M4 x 0.7	36	2.5	6	3.5	21	3.5	7.5	32	8
25	5 to 50	23.5	19	30	25.5	7	10	33.5	5	—	M5 x 0.8	40	2.5	8	4.5	24	3.5	8	36	8
32	5 to 50	26	21	32.5	27.5	12	12	41	5	—	M6 x 1.0	51	2.5	10	5	31	4.5	9	43.5	10
40	5 to 50	31	25	37.5	31.5	13	14	47	6	—	M8 x 1.25	60	3.5	12	6	37	4.5	11	50.5	10

JCQ Series

Bore Size

ø50 to ø100

Standard (Through-hole): JCQ, JCDQ

ø50 to ø80

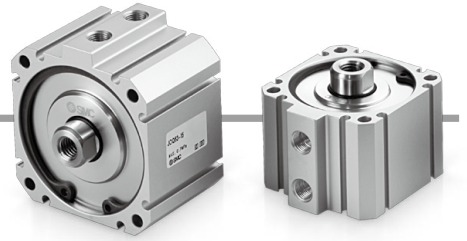

Both ends tapped: JCQA, JCDQA

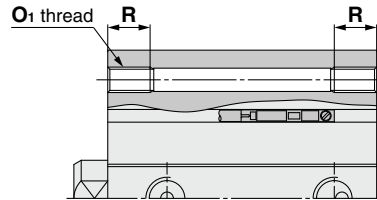

Both Ends Tapped [mm]

Bore size	O ₁	R
50	M6 x 1.0	10
63	M6 x 1.0	10
80	M10 x 1.5	18
100	M10 x 1.5	18

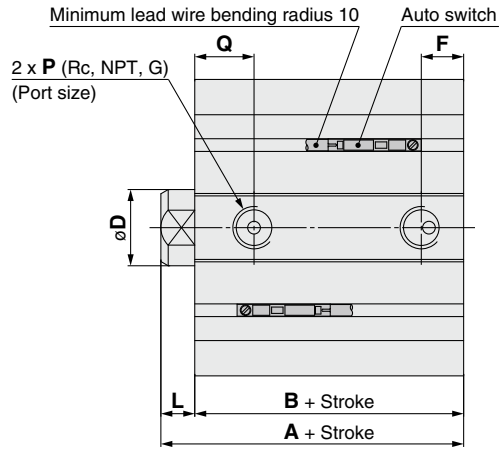
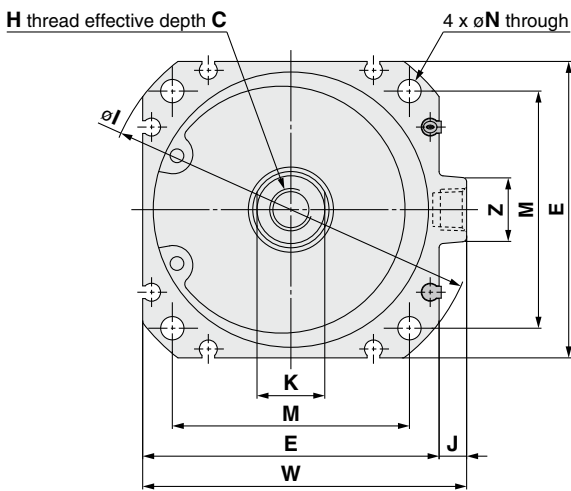

ø100

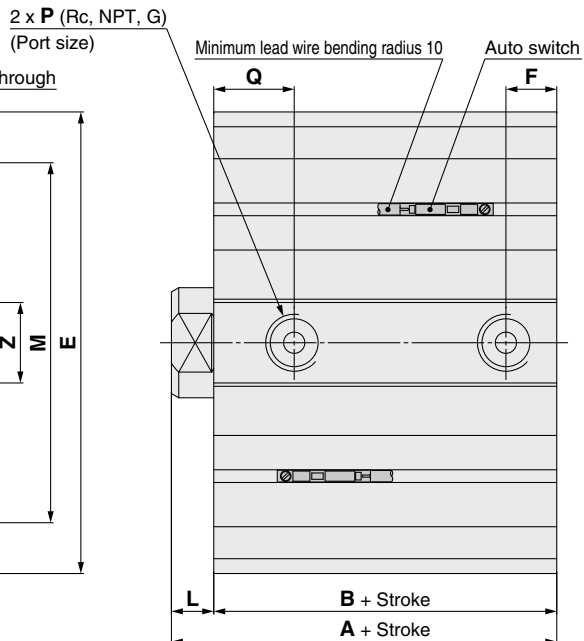
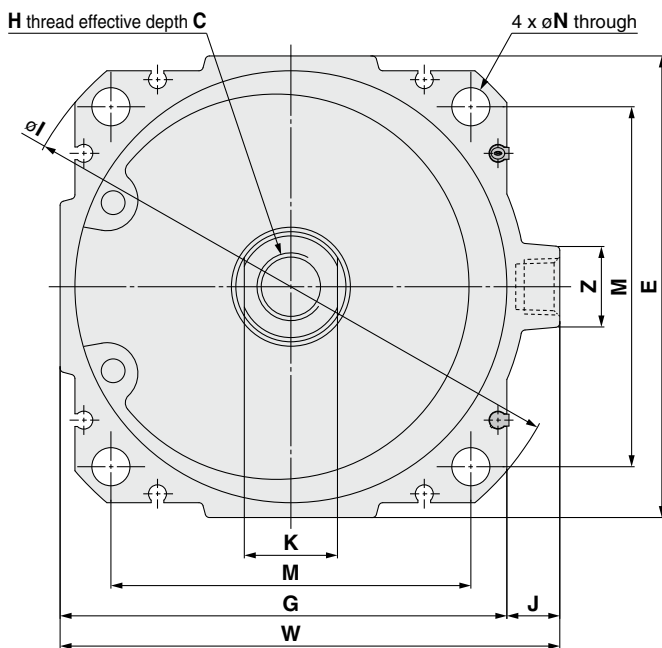

Standard

Bore size	Stroke range	Without magnet for auto switch		With magnet for auto switch		C	D	E	F	G	H	I	J	K	L	M	N	P	Q	W	Z
		A	B	A	B																
50	10 to 50	37	29	42.5	34.5	15	18	57	9	—	M10 x 1.5	74	6.5	16	8	46	5.5	1/8	13	63.5	15
63	10 to 50	41.5	33.5	46.5	38.5	15	18	70	10	—	M10 x 1.5	88	6.5	16	8	56	5.5	1/8	14	76.5	15
80	10 to 50	49	40	55	46	21	22	89	12	—	M14 x 2.0	113	9	19	9	70	9	1/4	14	98	19
100	10 to 50	56	46	62	52	21	26	109	12	105.5	M16 x 2.0	134	12.5	22	10	85	9	1/4	19	118	19

Auto Switch Mounting

Auto Switch Proper Mounting Position (Detection at stroke end) and Mounting Height

D-M9□
 D-M9□W
 D-M9□A
 D-M9□V
 D-M9□WV
 D-M9□AV

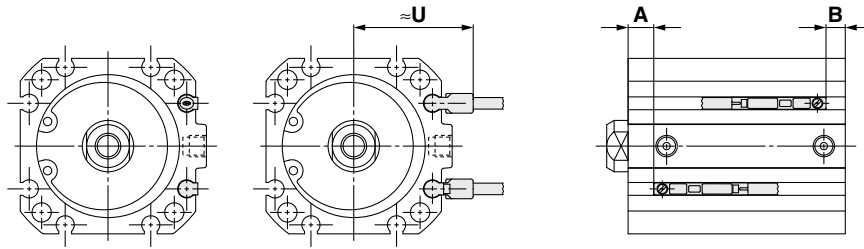

Auto Switch Proper Mounting Position [mm]

Auto switch model	D-M9□ D-M9□V D-M9□W D-M9□WV D-M9□A D-M9□AV	
	A	B
Bore size		
12	5	2.5
16	5.5	3
20	6	6
25	6	7.5
32	8	8
40	11	9
50	11.5	11
63	13.5	13.5
80	16.5	18
100	19.5	21

Auto Switch Mounting Height [mm]

Auto switch model	D-M9□V	
	U	
Bore size		
12	19.5	
16	21	
20	23	
25	24.5	
32	28.5	
40	31.5	
50	36.5	
63	43	
80	52.5	
100	59	

Minimum Stroke for Auto Switch Mounting

Number of auto switches	[mm]			
	D-M9□V	D-M9□WV D-M9□AV	D-M9□	D-M9□W D-M9□A
1	5	10	15 (5)	15 (10)
2	5	15	15 (5)	15

Note) The dimension stated in () shows the minimum stroke for the auto switch mounting when the auto switch does not project from the end surface of the cylinder body and hinder the lead wire bending space. (Refer to the figure below.) The auto switch needs to be ordered separately.

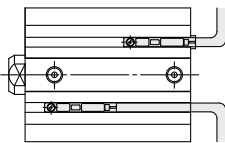

Operating Range

Auto switch model	[mm]									
	Bore size									
	12	16	20	25	32	40	50	63	80	100
D-M9□(V) D-M9□W(V) D-M9□A(V)*	3	3	4.5	4.5	4	4.5	5.5	6	6	6.5

* Values which include hysteresis are for guideline purposes only, they are not a guarantee (assuming approximately ±30% dispersion) and may change substantially depending on the ambient environment.

Auto Switch Mounting

Applicable auto switch	D-M9□/M9□V D-M9□W/M9□WV D-M9□A/M9□AV		
Bore size [mm]	φ12	φ16	φ20 to φ100
Surfaces with auto switch mounting slot			

Note) Auto switch mounting bracket and auto switch are enclosed with the cylinder for shipment. For an environment that needs the water resistant auto switch, select the D-M9□A(V) type.

Mounting of auto switch

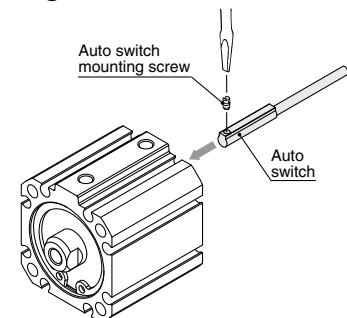

- When tightening the auto switch mounting screw, use a watchmakers' screwdriver with a handle 5 to 6 mm in diameter.

Tightening Torque for Auto Switch Mounting Screw [N·m]

Auto switch model	Tightening torque
D-M9□(V) D-M9□W(V) D-M9□A(V)	0.05 to 0.15

Prior to Use

Auto Switch Connection and Example

Sink Input Specifications

3-wire, NPN

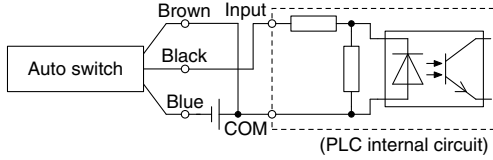

2-wire

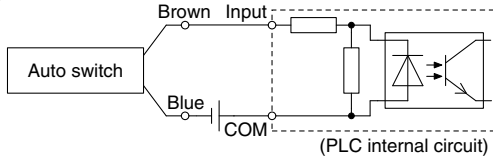

Source Input Specifications

3-wire, PNP

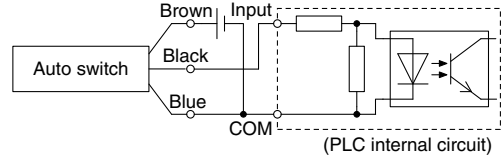

2-wire

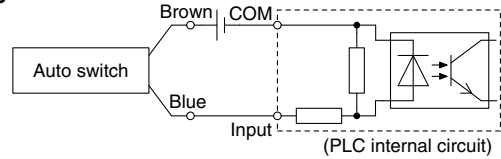

Connect according to the applicable PLC input specifications, as the connection method will vary depending on the PLC input specifications.

Example of AND (Series) and OR (Parallel) Connection

* When using solid state auto switches, ensure the application is set up so the signals for the first 50 ms are invalid.

3-wire AND connection for NPN output

(Using relays)

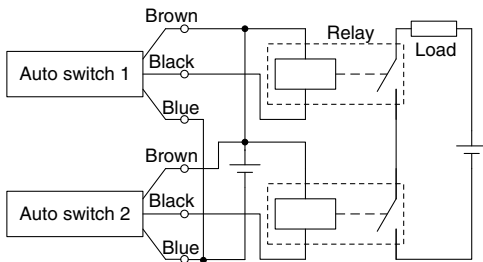

(Performed with auto switches only)

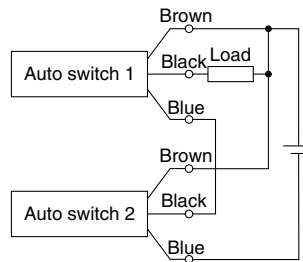

3-wire OR connection for NPN output

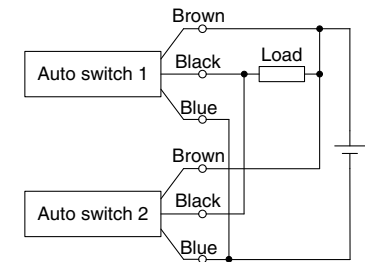

3-wire AND connection for PNP output

(Using relays)

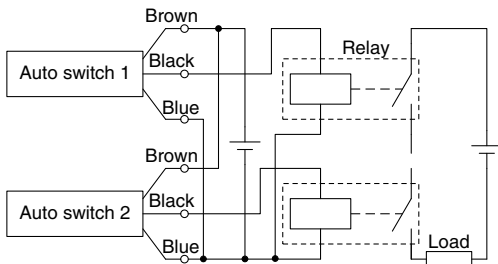

(Performed with auto switches only)

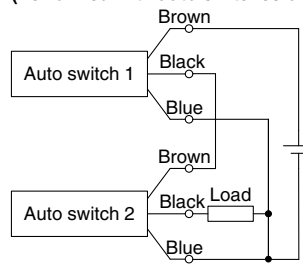

3-wire OR connection for PNP output

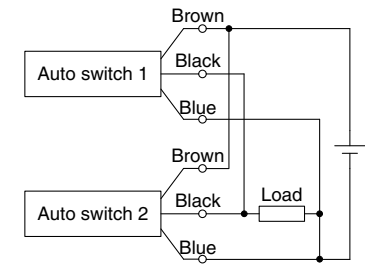

2-wire AND connection

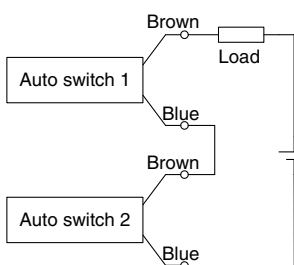

When two auto switches are connected in series, a load may malfunction because the load voltage will decline when in the ON state. The indicator lights will light up when both of the auto switches are in the ON state. Auto switches with load voltage less than 20 V cannot be used.

$$\begin{aligned} \text{Load voltage at ON} &= \text{Power supply voltage} - \\ &\quad \text{Residual voltage} \times 2 \text{ pcs.} \\ &= 24 \text{ V} - 4 \text{ V} \times 2 \text{ pcs.} \\ &= 16 \text{ V} \end{aligned}$$

Example: Power supply is 24 VDC
Internal voltage drop in auto switch is 4 V.

2-wire OR connection

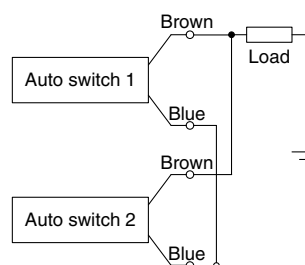

(Solid state)
When two auto switches are connected in parallel, malfunction may occur because the load voltage will increase when in the OFF state.

(Reed)
Because there is no current leakage, the load voltage will not increase when turned OFF. However, depending on the number of auto switches in the ON state, the indicator lights may sometimes grow dim or not light up, due to the dispersion and reduction of the current flowing to the auto switches.

$$\begin{aligned} \text{Load voltage at OFF} &= \text{Leakage current} \times 2 \text{ pcs.} \times \\ &\quad \text{Load impedance} \\ &= 1 \text{ mA} \times 2 \text{ pcs.} \times 3 \text{ k}\Omega \\ &= 6 \text{ V} \end{aligned}$$

Example: Load impedance is 3 k Ω .
Leakage current from auto switch is 1 mA.

Related Product

Specialized for JCQ $\phi 12$, $\phi 16$

RoHS

Speed Controller with One-touch Fitting Elbow Type for M3 AS12□1F-M3-□A-X790

⚠ Caution

Refer to Specific Product Precautions 2 on page 11 before use.

Metric size (Color: Light gray)

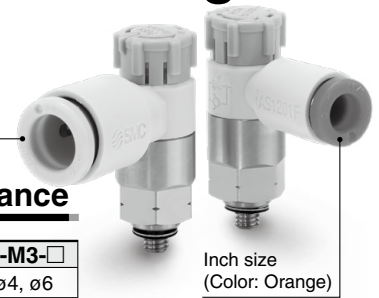

Inch size
(Color: Orange)

Specifications

Fluid	Air
Proof pressure	1.5 MPa
Max. operating pressure	1 MPa
Min. operating pressure	0.1 MPa
Ambient and fluid temperature	-5 to 60°C (No freezing)
Applicable tubing material	Nylon, Soft nylon, Polyurethane*1, FEP, PFA

*1 Use caution at the max. operating pressure when using soft nylon or polyurethane tubing. (Refer to the Web Catalog for details.)

Flow Rate and Sonic Conductance

Model		AS12□1F-M3-□
Tubing O.D.	Metric size	$\phi 2$, $\phi 3.2$, $\phi 4$, $\phi 6$
C values: Sonic conductance dm ³ /(s·bar)	Free flow	0.07
	Controlled flow	0.07
b values: Critical pressure ratio	Free flow	0.3
	Controlled flow	0.2

* C and b values are for controlled flow with the needle fully open and free flow with the needle fully closed.

How to Order

AS 1 2 0 1 F - M3 - 06 A - X790

Body size
1 M3 x 0.5

Port size
M3 M3 x 0.5

Type
2 Elbow

Control type*1
0 Meter-out
1 Meter-in

*1 Meter-out and meter-in types can be visually identified by the color of the knob.

Push-lock type

Applicable tubing O.D.

Metric size*1	Inch size*1
02 $\phi 2^*3$	01 $\phi 1/8''$
23 $\phi 3.2^*2$	03 $\phi 5/32''$
04 $\phi 4$	
06 $\phi 6$	

*1 Metric size: Light gray
Inch size: Orange

*2 $\phi 1/8''$ tubing.

*3 Only polyurethane tubing is applicable for $\phi 2$.

Needle Valve/Flow Rate Characteristics

AS1201F-M3-□

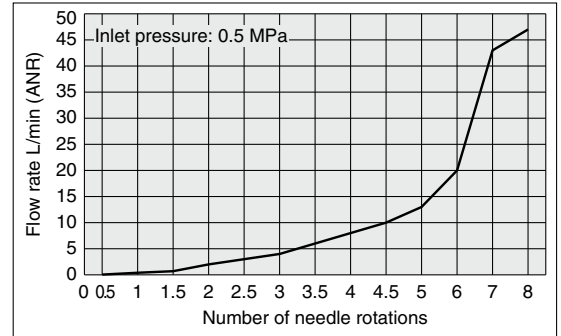

Dimensions

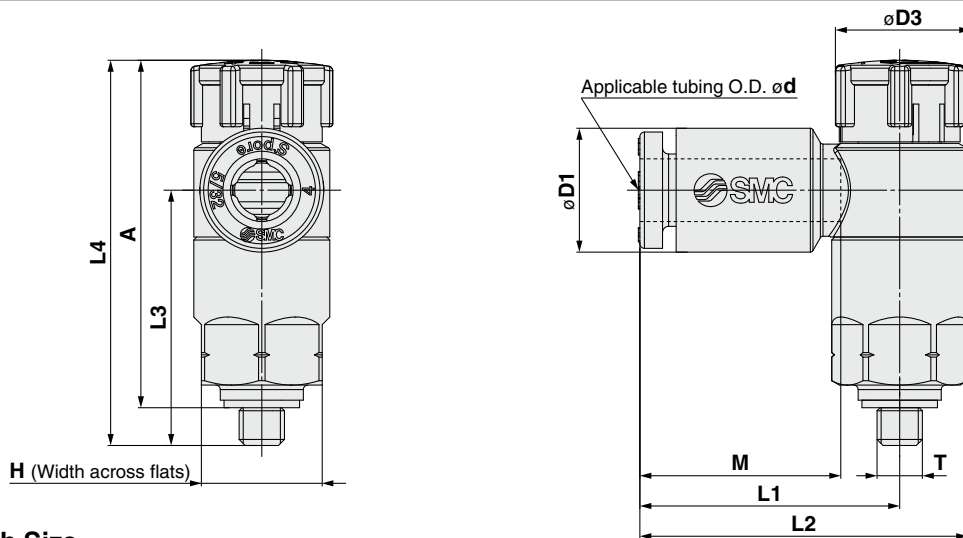

Metric Size/Inch Size

Model	d	T	H	D1	D3	L1	L2	L3	L4*1		A*2		M	Weight [g]
									Unlocked	Locked	Unlocked	Locked		
AS12□1F-M3-02A-X790	2	M3 x 0.5	8	5.8	9.4	15.8	20.3	16.9	26.5	25.4	23.5	22.4	11.9	5
AS12□1F-M3-23A-X790	3.2			7.2		17.2	21.7							
AS12□1F-M3-04A-X790	4			8.2		18.6	23.1							
AS12□1F-M3-06A-X790	6			10.4		17.2	21.7							
AS12□1F-M3-01A-X790	1/8"			7.2										
AS12□1F-M3-03A-X790	5/32"	8.2												

*1 Reference dimensions

*2 Reference dimensions of threads after installation



Specific Product Precautions 1

Be sure to read this before handling the products. Refer to the back cover for Safety Instructions. For Actuator and Auto Switch Precautions, refer to “Handling Precautions for SMC Products” and the Operation Manual on SMC website, <http://www.smcworld.com>

Mounting

Caution

Compact cylinders are designed to create compact mechanical equipment and promote space saving. Thus, if it is used in the same manner as conventional cylinders such as tie-rod cylinders, it may degrade the performance. Pay sufficient attention to the operating conditions when using.

1. Allowable lateral load

Lateral load that can apply to the piston rod end is limited. If a cylinder is used with a lateral load over the limit, it may cause air leakage due to abnormal friction of seals, galling of cylinder tubes and pistons, or abnormal friction of the bearing part. The lateral load applied to the piston rod must be within the allowable range indicated in this catalog. When the load exceeds the limit, install a guide or change the bore size to suit the load in order to make the load within the allowable range.

2. Connection with a workpiece

When a workpiece is mounted on the piston rod end, connect them aligning the center of piston rod and a workpiece. If they are off-center, lateral load is generated and phenomena mentioned in (1) may occur. In order not to apply the off-center load, use of a floating joint or simple joint is recommended.

3. Simultaneous use of multiple cylinders

It is difficult to control the speed of pneumatic cylinders. The following conditions cause speed change: change in supply pressure, load, temperature and lubrication, performance difference of each cylinder, deterioration of each part over time, etc. Speed controller can be used to control the speed of multiple cylinders simultaneously for a short period of time, but depending on conditions, it may not work as desired. If multiple cylinders cannot operate simultaneously, unreasonable force is applied to the piston rod because cylinder positions may not be the same. This may cause abnormal friction of seals and bearings, and galling of cylinder tubes and pistons. Do not use an application to operate several cylinders simultaneously by adjusting cylinder speed. If this is inevitable, use a high rigid guide against load, so that the cylinder is not damaged even when the each cylinder output is slightly different.

4. Depending on the system configuration selected, the specified speed may not be satisfied.



JCQ Series

Specific Product Precautions 2

Be sure to read this before handling the products. Refer to the back cover for Safety Instructions. For Actuator and Auto Switch Precautions, refer to "Handling Precautions for SMC Products" and the Operation Manual on SMC website, <http://www.smcworld.com>

Mounting Fittings and Speed Controllers (for $\phi 12$ to $\phi 32$)

Caution

Use the series models listed below when connecting speed controllers and fittings directly to cylinders.

- After tightening the fitting by hand, use a wrench to tighten the fitting an additional approximately 1/4 turn for a port size of M3 x 0.5 or 1/6 turn for a port size of M5 x 0.8. For elbow type fittings, tighten an additional 1/2 turn for a port size of M3 x 0.5 or 1/3 turn for a port size of M5 x 0.8 if gaskets are mounted in two places. If screws are tightened excessively, air leakage may result due to broken threads or a deformed gasket. If screws are tightened insufficiently, looseness and accompanying air leakage are likely to occur.

<One-touch Fittings>

With Magnet for Auto Switch

Bore size [mm]		12	16	20	25	32	
Port size		M3 x 0.5		M5 x 0.8			
Stroke [mm]		5 or more	5 or more	5 or more	5 or more	5 or more	
Male connector (with hexagon socket head)	KQ2S04-M3G	●	●	—	—	—	
	KQ2S04-M5□	—	—	●	●	●	
	KQ2S06-M5□	—	—	●	●	●	
Male connector	KQ2H04-M3G	○	○	—	—	—	
	KQ2H04-M5□	—	—	○	●	●	
	KQ2H06-M5□	—	—	○	○	○	
Male elbow	KQ2L04-M3G	●	●	—	—	—	
	KQ2L04-M5□	—	—	●	●	●	
	KQ2L06-M5□	—	—	●	●	●	

- : Applicable to mounting condition 1 and 2.
- : Applicable to mounting condition 1.

Without Magnet for Auto Switch

Bore size [mm]		12	16	20	25	32		
Port size		M3 x 0.5		M5 x 0.8				
Stroke [mm]		5 or more	5 or more	5	10 or more	5	10 or more	5 or more
Male connector (with hexagon socket head)	KQ2S04-M3G	●	●	—	—	—	—	—
	KQ2S04-M5□	—	—	●	—	●	—	●
	KQ2S06-M5□	—	—	●	●	●	●	●
Male connector	KQ2H04-M3G	○	○	—	—	—	—	—
	KQ2H04-M5□	—	—	●	●	●	●	●
	KQ2H06-M5□	—	—	—	○	—	○	○
Male elbow	KQ2L04-M3G	●	●	—	—	—	—	—
	KQ2L04-M5□	—	—	●	●	●	●	●
	KQ2L06-M5□	—	—	●	●	●	●	●

- : Applicable to mounting condition 1 and 2.
- : Applicable to mounting condition 1.

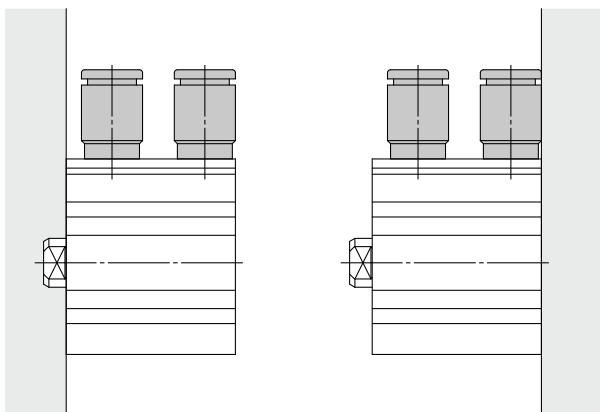

Mounting condition 1

Mounting condition 2

* The above figures show the mounting conditions with the KQ2S One-touch fittings.

<Speed Controllers>

With Magnet for Auto Switch

Bore size [mm]		12	16	20	25	32	
Port size		M3 x 0.5		M5 x 0.8			
Stroke [mm]		5 or more	5 or more	5 or more	5 or more	5 or more	
Elbow type	AS12□1F-M3-04	●	●	—	—	—	
	AS12□1F-M3-□A-X790	○	○	—	—	—	
	AS12□1F-M5E-04A	—	—	●	●	●	
	AS12□1F-M5E-06A	—	—	●	●	●	
Universal type	AS13□1F-M3-04	●	●	—	—	—	
	AS13□1F-M5E-04A	—	—	●	●	●	
	AS13□1F-M5E-06A	—	—	●	●	●	

- : Applicable to mounting condition 1 and 2.
- : Applicable to mounting condition 1.

Without Magnet for Auto Switch

Bore size [mm]		12	16	20	25	32	
Port size		M3 x 0.5		M5 x 0.8			
Stroke [mm]		5 or more	5 or more	5 or more	5 or more	5 or more	
Elbow type	AS12□1F-M3-04	●	●	—	—	—	
	AS12□1F-M3-□A-X790	○	○	—	—	—	
	AS12□1F-M5E-04A	—	—	●	●	●	
	AS12□1F-M5E-06A	—	—	●	●	●	
Universal type	AS13□1F-M3-04	●	●	—	—	—	
	AS13□1F-M5E-04A	—	—	●	●	●	
	AS13□1F-M5E-06A	—	—	●	●	●	

- : Applicable to mounting condition 1 and 2.
- : Applicable to mounting condition 1.

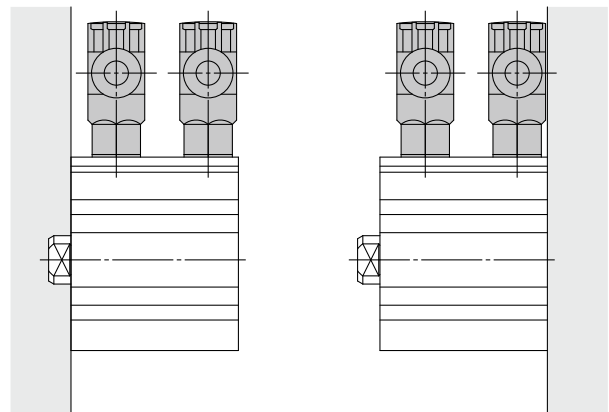

Mounting condition 1

Mounting condition 2

* The above figures show the mounting conditions with the AS12□1F-M5E-□A elbow type speed controllers.

Safety Instructions

These safety instructions are intended to prevent hazardous situations and/or equipment damage. These instructions indicate the level of potential hazard with the labels of “**Caution**,” “**Warning**” or “**Danger**.” They are all important notes for safety and must be followed in addition to International Standards (ISO/IEC)*1), and other safety regulations.

 **Caution:** **Caution** indicates a hazard with a low level of risk which, if not avoided, could result in minor or moderate injury.

 **Warning:** **Warning** indicates a hazard with a medium level of risk which, if not avoided, could result in death or serious injury.

 **Danger:** **Danger** indicates a hazard with a high level of risk which, if not avoided, will result in death or serious injury.

*1) ISO 4414: Pneumatic fluid power – General rules relating to systems.
ISO 4413: Hydraulic fluid power – General rules relating to systems.
IEC 60204-1: Safety of machinery – Electrical equipment of machines.
(Part 1: General requirements)
ISO 10218-1: Manipulating industrial robots – Safety.
etc.

Warning

1. The compatibility of the product is the responsibility of the person who designs the equipment or decides its specifications.

Since the product specified here is used under various operating conditions, its compatibility with specific equipment must be decided by the person who designs the equipment or decides its specifications based on necessary analysis and test results. The expected performance and safety assurance of the equipment will be the responsibility of the person who has determined its compatibility with the product. This person should also continuously review all specifications of the product referring to its latest catalog information, with a view to giving due consideration to any possibility of equipment failure when configuring the equipment.

2. Only personnel with appropriate training should operate machinery and equipment.

The product specified here may become unsafe if handled incorrectly. The assembly, operation and maintenance of machines or equipment including our products must be performed by an operator who is appropriately trained and experienced.

3. Do not service or attempt to remove product and machinery/equipment until safety is confirmed.

1. The inspection and maintenance of machinery/equipment should only be performed after measures to prevent falling or runaway of the driven objects have been confirmed.
2. When the product is to be removed, confirm that the safety measures as mentioned above are implemented and the power from any appropriate source is cut, and read and understand the specific product precautions of all relevant products carefully.
3. Before machinery/equipment is restarted, take measures to prevent unexpected operation and malfunction.

4. Contact SMC beforehand and take special consideration of safety measures if the product is to be used in any of the following conditions.

1. Conditions and environments outside of the given specifications, or use outdoors or in a place exposed to direct sunlight.
2. Installation on equipment in conjunction with atomic energy, railways, air navigation, space, shipping, vehicles, military, medical treatment, combustion and recreation, or equipment in contact with food and beverages, emergency stop circuits, clutch and brake circuits in press applications, safety equipment or other applications unsuitable for the standard specifications described in the product catalog.
3. An application which could have negative effects on people, property, or animals requiring special safety analysis.
4. Use in an interlock circuit, which requires the provision of double interlock for possible failure by using a mechanical protective function, and periodical checks to confirm proper operation.

Caution

1. The product is provided for use in manufacturing industries.

The product herein described is basically provided for peaceful use in manufacturing industries.
If considering using the product in other industries, consult SMC beforehand and exchange specifications or a contract if necessary.
If anything is unclear, contact your nearest sales branch.

Limited warranty and Disclaimer/ Compliance Requirements

The product used is subject to the following “Limited warranty and Disclaimer” and “Compliance Requirements”.

Read and accept them before using the product.

Limited warranty and Disclaimer

1. The warranty period of the product is 1 year in service or 1.5 years after the product is delivered, whichever is first.*2)
Also, the product may have specified durability, running distance or replacement parts. Please consult your nearest sales branch.
2. For any failure or damage reported within the warranty period which is clearly our responsibility, a replacement product or necessary parts will be provided.
This limited warranty applies only to our product independently, and not to any other damage incurred due to the failure of the product.
3. Prior to using SMC products, please read and understand the warranty terms and disclaimers noted in the specified catalog for the particular products.

*2) Vacuum pads are excluded from this 1 year warranty.

A vacuum pad is a consumable part, so it is warranted for a year after it is delivered.
Also, even within the warranty period, the wear of a product due to the use of the vacuum pad or failure due to the deterioration of rubber material are not covered by the limited warranty.

Compliance Requirements

1. The use of SMC products with production equipment for the manufacture of weapons of mass destruction (WMD) or any other weapon is strictly prohibited.
2. The exports of SMC products or technology from one country to another are governed by the relevant security laws and regulations of the countries involved in the transaction. Prior to the shipment of a SMC product to another country, assure that all local rules governing that export are known and followed.

Caution

SMC products are not intended for use as instruments for legal metrology.

Measurement instruments that SMC manufactures or sells have not been qualified by type approval tests relevant to the metrology (measurement) laws of each country. Therefore, SMC products cannot be used for business or certification ordained by the metrology (measurement) laws of each country.

Revision history

Edition B	* Bore sizes $\phi 40$, $\phi 50$, $\phi 63$ added.	TR
Edition C	* Both ends tapped mounting added. * Bore sizes $\phi 80$, $\phi 100$ added. * Port thread types NPT, G added.	UR

 **Safety Instructions** Be sure to read the “Handling Precautions for SMC Products” (M-E03-3) and “Operation Manual” before use.