

Speed Controller with One-touch Fittings

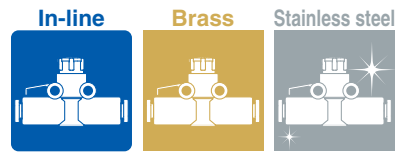

In-line Type

Reduces flow setting time!

Easy to use

Push-lock type

Knob O.D.: Almost doubled!

• Easy to lock

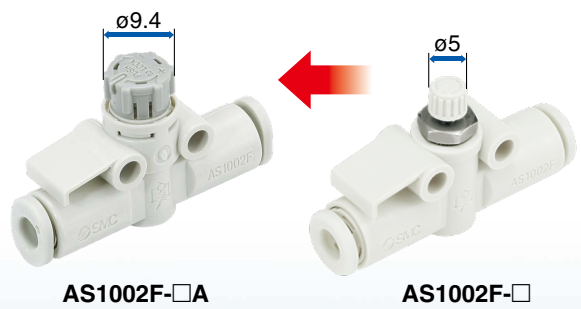
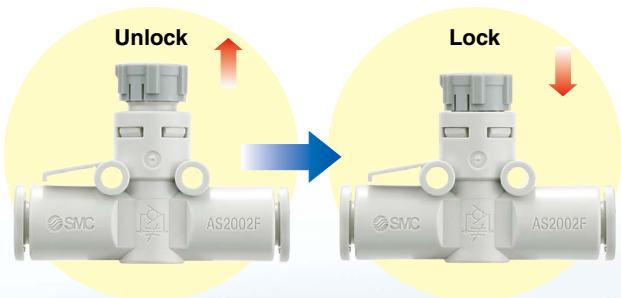

Push-lock type

Current type

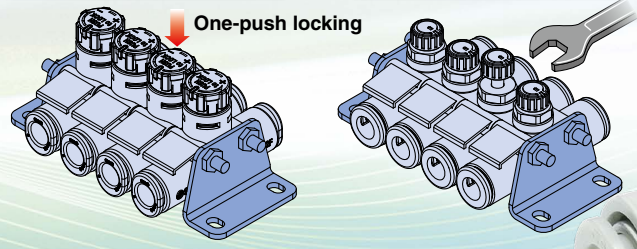

Much easier to lock than the current type which requires a wrench

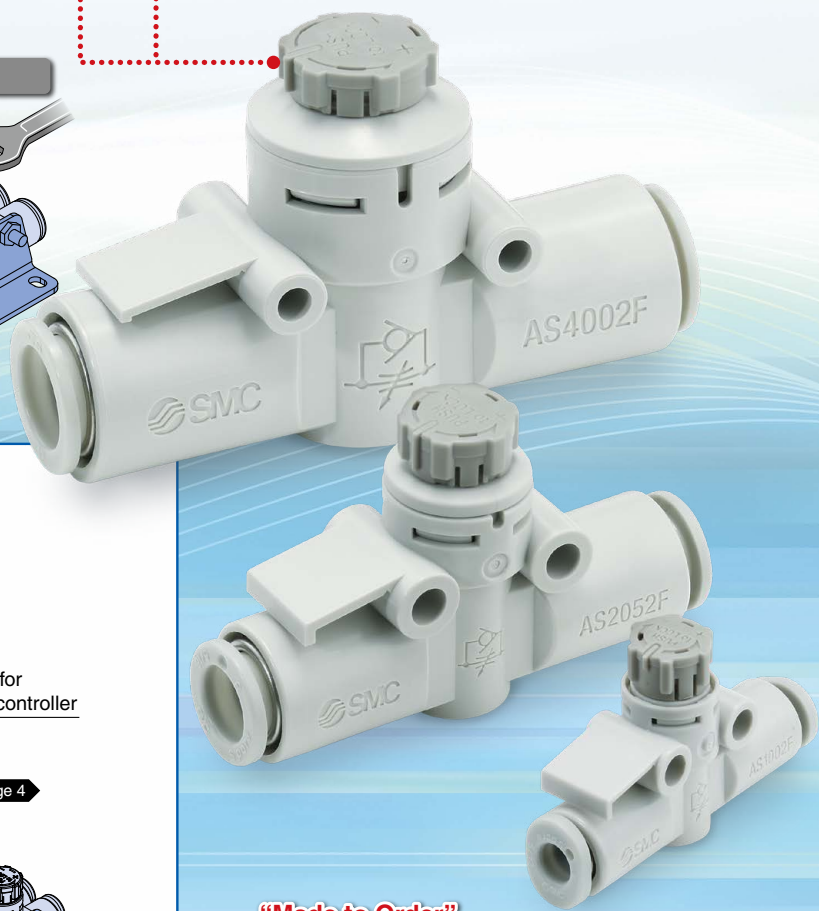

Mounting Variations

• Direct mounting

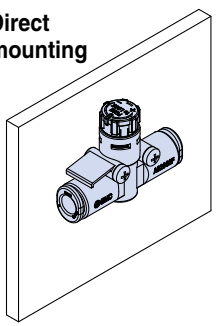

• Holder mounting [Page 10](#)

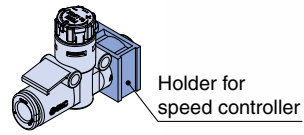

• DIN rail mounting [Page 4](#)

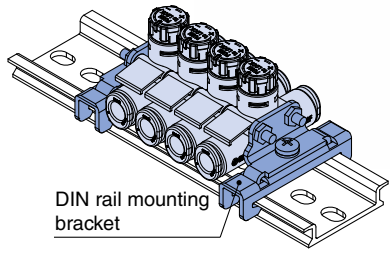

• L-bracket mounting [Page 4](#)

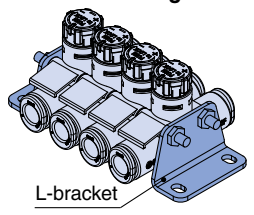

“Made to Order” section has been added. [Pages 3, 8](#)

- Lubricant: Vaseline -X12
- Grease-free + Restrictor -X21
- Restrictor -X214
- Clean Series 10-

AS Series

Flow Rate Reproducibility

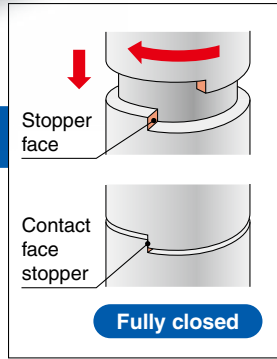

Improved reproducibility of flow rate

Stable knob position when fully closed (no flow rate) onto the contact face stopper (rotating stopper).
Minimal flow rate variations between knob rotations

Lightweight

Weight: Approx. **27% lighter**

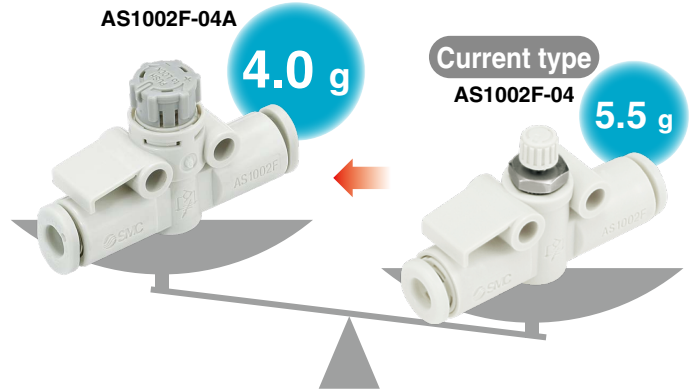

Larger Knob

Current type



ø5 mm

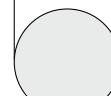

Hard to hold small knob
Hard to make fine adjustments

Actual size



ø9.4 mm

ø12 mm

ø13 mm

ø16.6 mm

ø18.8 mm



Easy to turn large knob
Easy to make fine adjustments

AS1002F

AS2002F

AS2052F

AS3002F

AS4002F

Easy Identification of Product Type

By index plate



It is possible to identify the product when multiple controllers are mounted and identify the flow direction by attaching an identification label.



Index plate

(Example with identification label attached)

By color

Model	Release button color	
	Metric	Inch
 AS□2F	Light gray	Orange
 AS□2FG	White	White

Series Variations

⊙ The electroless nickel plating type is standardized. ⊚ The stainless steel type is standardized.

	Model	Applicable tubing O.D.										Metal parts material	Applicable tubing material		
		Metric size					Inch size								
		3.2	4	6	8	10	12	1/8"	5/32"	1/4"	5/16"			3/8"	1/2"
	AS1002F	●	●	●				●	●	●				· Brass · Stainless steel	Nylon (T, TIA series) Soft nylon (TS, TISA series) Polyurethane (T, TIUB series) Fluoropolymer (TLM, TILM series) (TH, TIH series)
	AS2002F		●	●					●	●					
	AS2052F			●	●					●	●				
	AS3002F			●	●	●	●			●	●	●			
	AS4002F				●	●						●	●		



Made to Order (Pages 3, 8)

Restrictor

- Flow control of air blow and air purge

Grease-free (Seal: Fluorine-coated) + Restrictor (Without check valve)	-X21
Restrictor (Without check valve)	-X214

Push-Lock Series Variations

Speed Controller with One-touch Fitting **AS Series**

Push locking allows the needle to lock easily.

Body size	Port size	Applicable tubing O.D.	
		Metric size	Inch size
1 to 4	M5 to 1/2	ø2 to ø16	ø1/8" to ø1/2"



Refer to the **Web Catalog** for details.

Speed Controller with Indicator **AS-FS Series**

The numerical indication of flow rate knob rotations reduces flow setting time and setting errors!

Body size	Port size	Applicable tubing O.D.	
		Metric size	Inch size
1 to 4	M5 to 1/2	ø2 to ø16	ø1/8" to ø1/2"

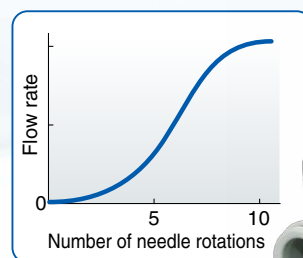

Refer to the **Web Catalog** for details.

Speed Controller with One-touch Fittings (In-line Type)

AS Series

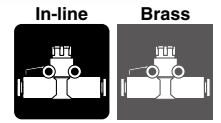
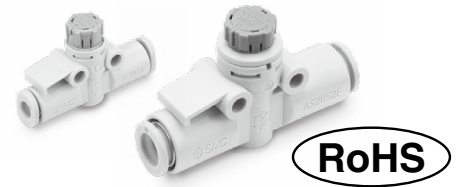

Model

Model	Applicable tubing O.D.												
	Metric size						Inch size						
	3.2	4	6	8	10	12	1/8"	5/32"	1/4"	5/16"	3/8"	1/2"	
AS1002F	●	●	●				●	●	●				
AS2002F		●	●					●	●				
AS2052F			●	●					●	●			
AS3002F			●	●	●	●			●	●	●		
AS4002F					●	●					●	●	

Specifications

Fluid	Air
Proof pressure	1.5 MPa
Max. operating pressure	1 MPa
Min. operating pressure	0.1 MPa
Ambient and fluid temperatures	-5 to 60°C (No freezing)
Applicable tubing material	Nylon, Soft nylon, Polyurethane*1, FEP, PFA

*1 Use caution at the max. operating pressure when using soft nylon or polyurethane tubing. (Refer to the Web Catalog for details.)

Flow Rate and Sonic Conductance

Model		AS1002F-□A			AS2002F-□A			AS2052F-□A			AS3002F-□A			AS4002F-□A	
Tubing O.D.	Metric size	ø3.2	ø4	ø6	ø4	ø6	ø6	ø8	ø6	ø8	ø10	ø12	ø10	ø12	
	Inch size	ø1/8"	ø5/32"	ø1/4"	ø5/32"	ø1/4"	ø1/4"	ø5/16"	ø1/4"	ø5/16"	ø3/8"	—	ø3/8"	ø1/2"	
C values: Sonic conductance dm ³ /(s·bar)	Free flow	0.3	0.4	0.6	0.4	0.6	1.0	1.2	1.1	1.6	2.2	2.6	2.4	3.5	
	Controlled flow	0.3			0.4	0.6	1.0	1.2	1.3	1.9	2.7	3.3	2.8	4.1	
b values: Critical pressure ratio	Free flow	0.3	0.2		0.3	0.1	0.2		0.2			0.3	0.2		
	Controlled flow	0.2	0.3	0.4	0.2		0.2	0.3	0.1		0.2	0.1	0.2		

Flow Direction Symbol on Body

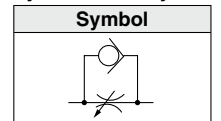

* C and b values are for controlled flow with the needle fully open and free flow with the needle fully closed.

* The same specifications also apply to the AS-FG series (stainless steel type).

How to Order

AS **200** 2 F - **06** A -

Body size

100	M5 standard
200	1/8 standard
205	1/4 standard
300	3/8 standard
400	1/2 standard

Made to Order

Push-lock type

Applicable tubing O.D.*1

Metric size	Inch size
23	ø3.2*2
04	ø4
06	ø6
08	ø8
10	ø10
12	ø12
01	ø1/8"
03	ø5/32"
07	ø1/4"
09	ø5/16"
11	ø3/8"
13	ø1/2"

*1 For selecting applicable tubing O.D., refer to the "Model" shown above.

*2 Use ø1/8" tubing.

With One-touch fittings

Made to Order



Lubricant: Vaseline **-X12**

Example) AS2002F-04A-X12

Grease-free (Seal: Fluorine-coated) + Restrictor (Without check valve) **-X21**

Example) AS2002F-04A-X21

* Not particle-free

Restrictor (Without check valve) **-X214**

Example) AS2002F-04A-X214

Clean Series **10-**

Example) 10-AS2002F-04A

*1 Fluorine grease is used.

*2 The cleanliness class (ISO class) is 5.

Caution

Be sure to read this before handling the products. Refer to the back cover for safety instructions. For flow control equipment precautions, refer to the "Handling Precautions for SMC Products" and the "Operation Manual" on the SMC website: <http://www.smcworld.com>

Options

① L-Bracket

Part no.	Applicable model
AS-10L	AS1002F□
AS-20L	AS2002F□
AS-25L	AS2052F□
AS-30L	AS3002F□
AS-40L	AS4002F□

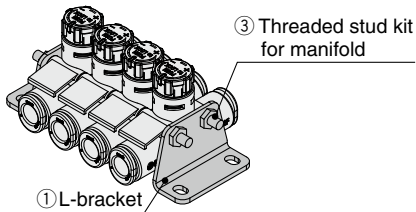

② DIN Rail Mounting Bracket

Part no.	Applicable model
AS-10D	AS1002F□
AS-20D	AS2002F□
AS-25D	AS2052F□
AS-30D	AS3002F□
AS-40D	AS4002F□

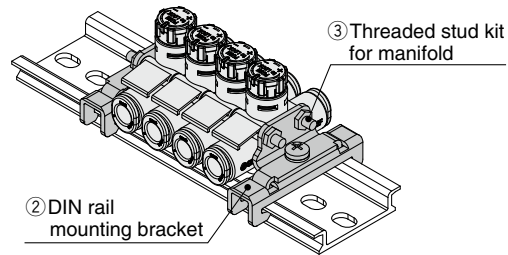

* Prepare DIN rail by user.

③ Threaded Stud Kit for Manifold: Metric Size

Part number				Applicable model
4 stations	6 stations	8 stations	10 stations	
AS-32B	AS-33B	AS-35B	AS-36B	AS1002F□-23A
			AS-37B	AS1002F□-04A
	AS-34B	AS-36B	AS-38B	AS1002F□-06A
			—	—
AS-32B	AS-34B	AS-36B	AS-37B	AS2002F□-04A
			AS-38B	AS2002F□-06A
AS-41B	AS-42B	AS-44B	AS-45B	AS2052F□-06A
			—	—
AS-42B	AS-44B	AS-45B	AS-47B	AS2052F□-08A
				AS3002F□-06A
				—
		AS-46B	AS-47B	AS3002F□-08A
				AS3002F□-10A
				—
AS-43B	AS-45B	AS-47B	AS-48B	AS3002F□-12A
				AS4002F□-10A
				—
—	—	—	—	AS4002F□-12A
—	—	—	—	—

③ Threaded Stud Kit for Manifold: Inch Size

Part number				Applicable model
4 stations	6 stations	8 stations	10 stations	
AS-32B	AS-33B	AS-35B	AS-36B	AS1002F□-01A
			AS-37B	AS1002F□-03A
	AS-34B	AS-36B	AS-38B	AS1002F□-07A
			—	AS2002F□-03A
AS-32B	AS-34B	AS-36B	AS-37B	—
			AS-38B	AS2002F□-07A
AS-41B	AS-42B	AS-44B	AS-45B	AS2052F□-07A
			—	AS2052F□-09A
AS-42B	AS-44B	AS-45B	AS-47B	AS3002F□-07A
				AS3002F□-09A
		AS-46B	AS-47B	AS3002F□-11A
				—
AS-43B	AS-45B	AS-47B	AS-48B	AS4002F□-11A
				—
				AS4002F□-13A

Details of Threaded Stud Kit for Manifold

Threaded stud			Accessories			
Part no.	Length	Quantity	Hexagon nut	Quantity	Flat washer	Quantity
AS-32B	62	2	M3	4	M3	4
AS-33B	72	2				
AS-34B	90	2				
AS-35B	104	2				
AS-36B	114	2				
AS-37B	135	2				
AS-38B	140	2	M4	4	M4	4
AS-41B	78	2				
AS-42B	111	2				
AS-43B	119	2				
AS-44B	147	2				
AS-45B	179	2				
AS-46B	191	2				
AS-47B	236	2				
AS-48B	277	2				

Ordering Example

Threaded studs for manifold are not included when L-bracket and DIN rail mounting bracket are ordered. Please order them according to the number of stations.

Ex.) AS2002F-04A

When connecting 4 pcs. and mounting L-brackets on both sides

- Speed controller
AS2002F-04A 4 pcs.
- L-bracket
AS-20L 2 pcs.
- Threaded stud kit for manifold
AS-32B 1 set

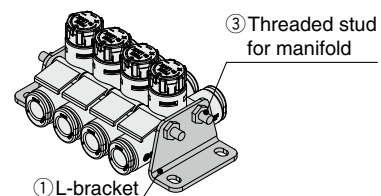

AS Series

Needle Valve: Flow Rate Characteristics

* The flow rate characteristics are representative values.

AS1002F-□A

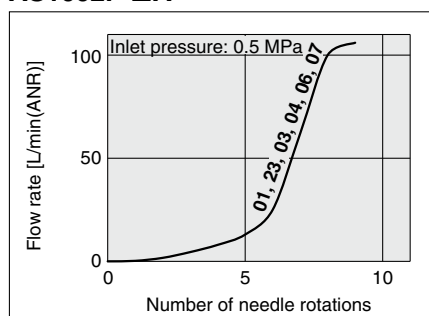

AS2002F-□A

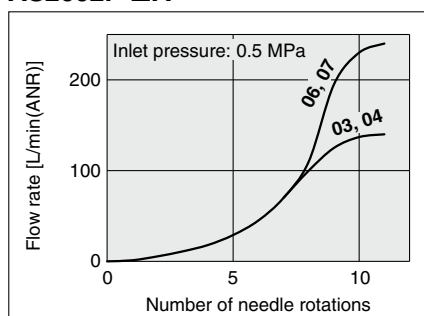

AS2052F-□A

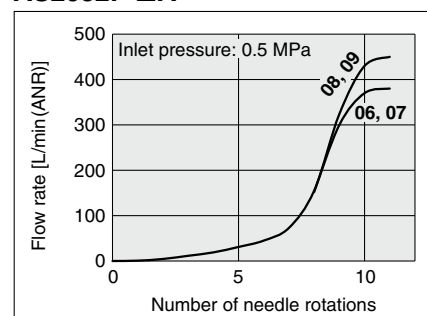

AS3002F-□A

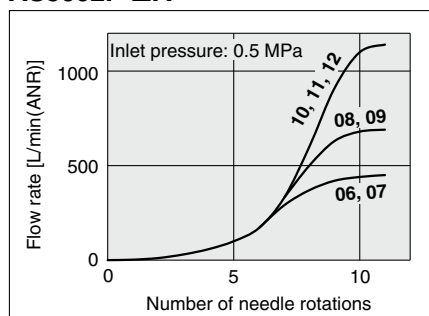

AS4002F-□A

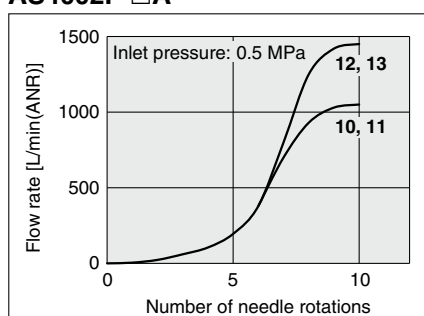

* The numbers above the flow rate characteristic curves in the charts show the applicable tubing outside diameter as defined by the product number.

Construction

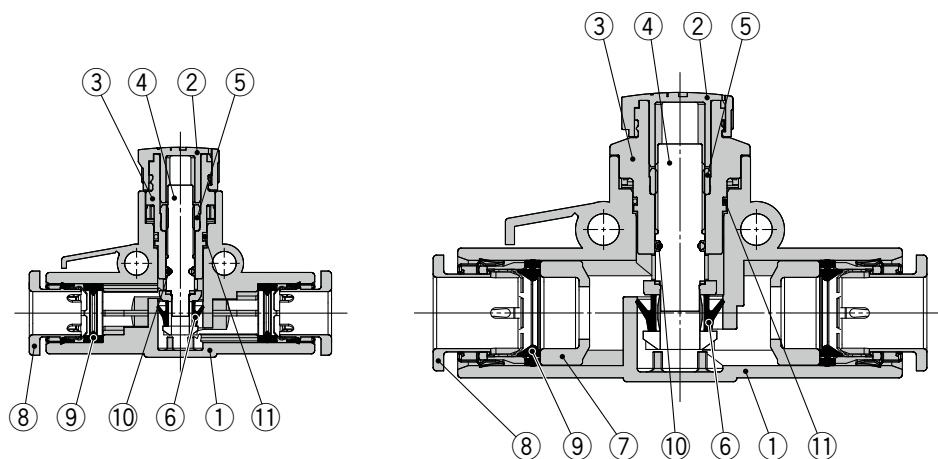

L-Bracket

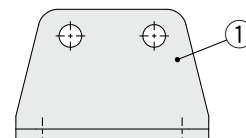

Component Parts

No.	Description	Material
1	Bracket	Steel strip

DIN Rail Mounting Bracket

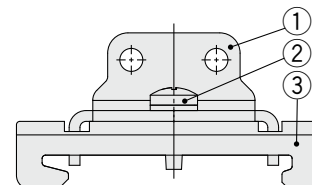

Component Parts

No.	Description	Material
1	Bracket	Steel strip
2	Cross recessed round head screw	Steel wire
3	Clasp	Steel strip

Component Parts

No.	Description	Material	Note
1	Body A	PBT	
2	Knob	POM	
3	Body B	PBT	
4	Needle	PBT	
5	Needle guide	Brass	Electroless nickel plating
6	U-seal	HNBR	
7	Spacer	PBT*1	
8	Cassette	—	
9	Seal	NBR	
10	O-ring	NBR	
11	O-ring	NBR	

*1 The AS3002F-11A, AS4002F-11A, AS4002F-13A are made of electroless nickel plated brass.

Dimensions

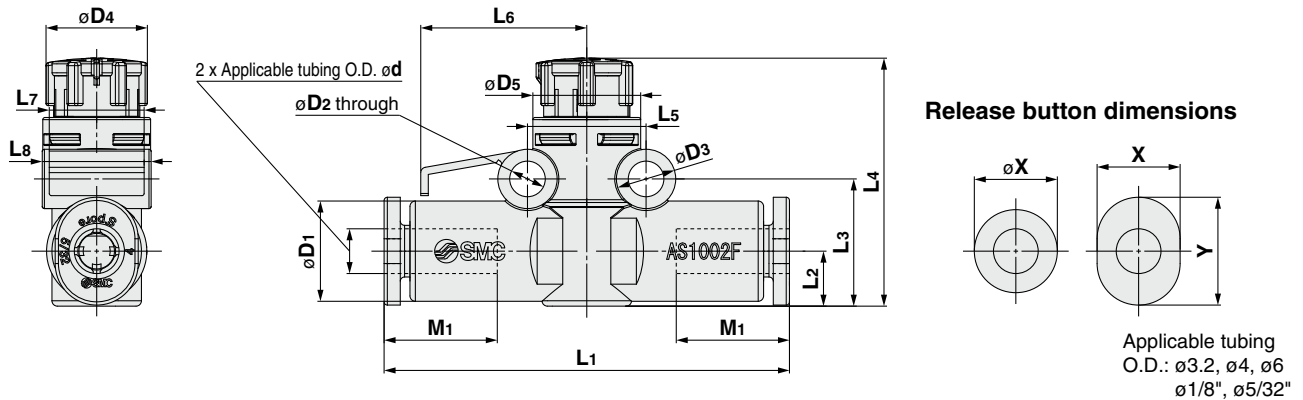

Metric Size

Model	Applicable tubing O.D. ϕd	$\phi D1$	Release button		$\phi D2$	$\phi D3$	$\phi D4$	$\phi D5$	L1	L2	L3	L4*1		L5	L6	L7	L8	M1	Weight [g]		
			$\phi X(X)$	Y								Max.	Min.								
AS1002F□-23A	3.2	8.4	6.7	9.5	3.3	5.5	9.4	10	36.6	5.1	11.8	24.1	23	11	15.4	8.8	10.1	13.5	3.7		
AS1002F□-04A	4	9.3	7.7	10					37.6										4		
AS1002F□-06A	6	11.6	9.7	12					40.1										6.1	12.8	25.1
AS2002F□-04A	4	9.3	7.7	10	3.3	5.5	12	12	41.3	6.3	13.4	31.4	30	12.6	17	10.5	12.3	13.5	6.1		
AS2002F□-06A	6	11.6	9.7	12					43.1										6.9		
AS2052F□-06A	6	12.8	11.5	—					52										7.6	17.2	36.2
AS2052F□-08A	8	15.2	13.5	—	4.3	7.8	13	16	56	8.5	18.1	37.1	35.5	17	22.5	12	16.1	17	13.8		
AS3002F□-06A	6	13.2	11.5	—					57.8										17	18.1	
AS3002F□-08A	8	15.2	13.5	—					63.8										9.8	21.7	42.9
AS3002F□-10A	10	18.5	16.5	—	4.5	8	16.6	20	68.6	10.9	22.8	44	42.4	21.8	25	12	20.5	21	24.8		
AS3002F□-12A	12	20.9	18.5	—					73.8										22.1	22	29.1
AS4002F□-10A	10	18.5	16.5	—					74.7										21	36.3	
AS4002F□-12A	12	21.7	18.5	—	4.3	8	18.8	26	79.1	11.3	23.7	51.3	49.7	28	33	14	26.2	22	42		

*1 Reference dimensions

Inch Size

Model	Applicable tubing O.D. ϕd	$\phi D1$	Release button		$\phi D2$	$\phi D3$	$\phi D4$	$\phi D5$	L1	L2	L3	L4*1		L5	L6	L7	L8	M1	Weight [g]				
			$\phi X(X)$	Y								Max.	Min.										
AS1002F□-01A	1/8"	8.4	6.7	9.5	3.3	5.5	9.4	10	36.6	5.1	11.8	24.1	23	11	15.4	8.8	10.1	13.5	3.7				
AS1002F□-03A	5/32"	9.3	7.7	10					37.6										4				
AS1002F□-07A	1/4"	12	10.9	—					40.1										6.2	12.9	25.2	24.1	5.2
AS2002F□-03A	5/32"	9.3	7.7	10	3.3	5.5	12	12	41.3	6.3	13.4	31.4	30	12.6	17	10.5	12.3	13.5	6.1				
AS2002F□-07A	1/4"	12	10.9	—					43.2										6.5	13.6	31.6	30.2	7.1
AS2052F□-07A	1/4"	13.2	12	—					52.2										7.6	17.2	36.2	34.6	17
AS2052F□-09A	5/16"	15.2	13.5	—	4.3	7.8	13	16	56	8.5	18.1	37.1	35.5	17	22.5	12	16.1	17	13.8				
AS3002F□-07A	1/4"	13.2	12	—					57.8										17	17.9			
AS3002F□-09A	5/16"	15.2	13.5	—					63.8										9.8	21.7	42.9	41.3	21.8
AS3002F□-11A	3/8"	18.5	16	—	4.5	8	16.6	20	67.6	11.3	23.7	51.3	49.7	28	33	14	26.2	21	25				
AS4002F□-11A	3/8"	18.5	16	—					74.7										21	36.7			
AS4002F□-13A	1/2"	21.7	20	—					79.1										22	40.4			

*1 Reference dimensions

AS Series

Dimensions

L-Bracket

Bracket on a single side

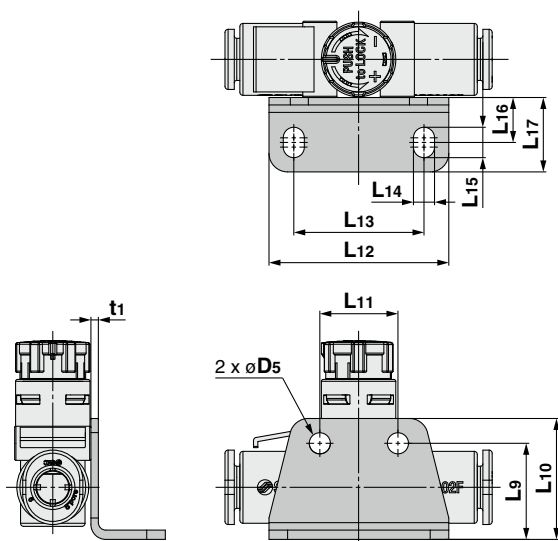

Part no.	Applicable model	D5	L9	L10	L11	L12	L13	L14	L15	L16	L17	t1
AS-10L	AS1002F□	3.4	14.8	18.3	11	27.5	19.5	3.4	4.9	7.3	12	1
AS-20L	AS2002F□		15.6	19.6	12.6	29	21					1.2
AS-25L	AS2052F□		19.6	24.6	17	38	28					1.4
AS-30L	AS3002F□	4.5	24.8	29.8	22	43	33	4.5	6.5	9.5	15.5	1.4
AS-40L	AS4002F□		25.7	30.7	28	49	39					

Brackets on both sides

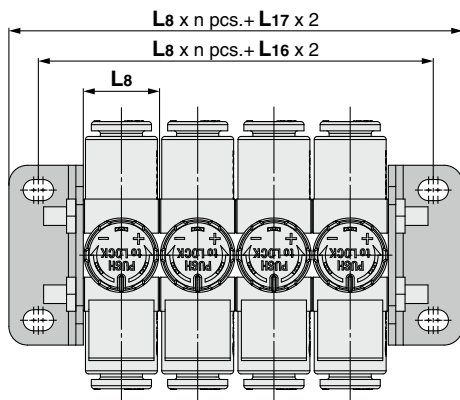

- * Refer to page 6 for L8.
- * The figure above shows the manifold with speed controllers connected using two L-brackets and a threaded stud kit for manifold. Refer to page 4 for threaded stud kits for manifold.

DIN Rail Mounting Bracket

Bracket on a single side

AS1002F□
AS2002F□

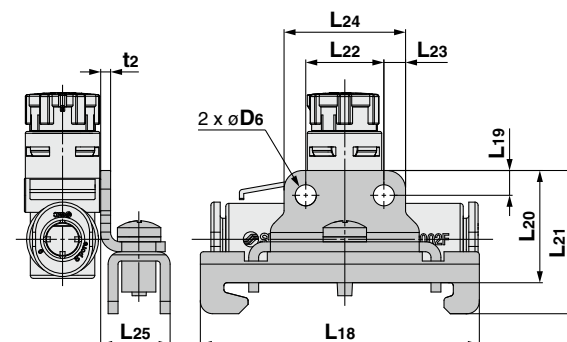
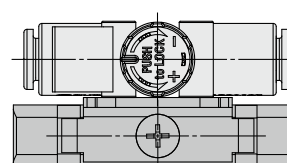

AS2052F□
AS3002F□
AS4002F□

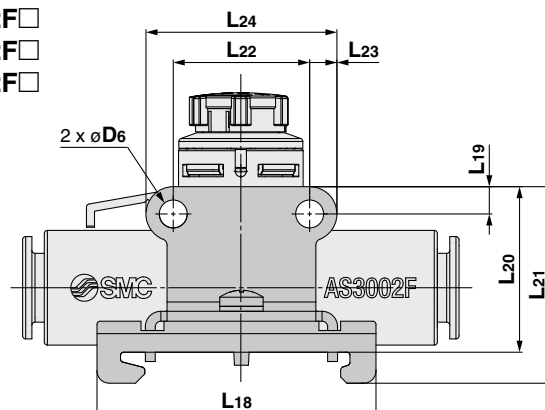

Part no.	Applicable model	D6	L18	L19	L20	L21	L22	L23	L24	L25	t2
AS-10D	AS1002F□	3.4	45	3.5	18.2	23.2	11	3.5	18	11.3	1.6
AS-20D	AS2002F□			4.4	18.6	23.6	12.6		19.6		
AS-25D	AS2052F□			22	27	17	25.8				
AS-30D	AS3002F□	4.5	4.4	27.2	32.2	22	4.4	30.8			
AS-40D	AS4002F□			28.1	33.1	28	36.8				

Brackets on both sides

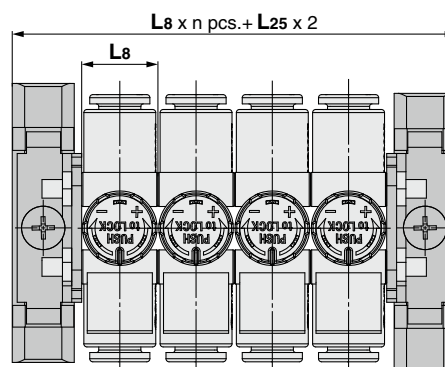

- * Refer to page 6 for L8.
- * The figure above shows the manifold with speed controllers connected using two DIN rail mounting brackets and a threaded stud kit for manifold. Refer to page 4 for threaded stud kits for manifold.

Stainless Steel Type Speed Controller with One-touch Fittings (In-line Type)

AS-FG Series

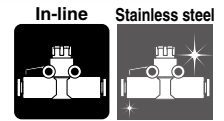

Model

Model	Applicable tubing O.D.												
	Metric size						Inch size						
	3.2	4	6	8	10	12	1/8"	5/32"	1/4"	5/16"	3/8"	1/2"	
AS1002FG	●	●	●				●	●	●				
AS2002FG		●	●					●	●				
AS2052FG			●	●					●	●			
AS3002FG			●	●	●	●			●	●		●	
AS4002FG					●	●						●	●

Specifications

Fluid	Air
Proof pressure	1.5 MPa
Max. operating pressure	1 MPa
Min. operating pressure	0.1 MPa
Ambient and fluid temperatures	-5 to 60°C (No freezing)
Applicable tubing material	Nylon, Soft nylon, Polyurethane*1, FEP, PFA

*1 Use caution at the max. operating pressure when using soft nylon or polyurethane tubing. (Refer to the Web Catalog for details.)

Flow Rate and Sonic Conductance

Model		AS1002FG-□A			AS2002FG-□A		AS2052FG-□A		AS3002FG-□A			AS4002FG-□A		
Tubing O.D.	Metric size	ø3.2	ø4	ø6	ø4	ø6	ø6	ø8	ø6	ø8	ø10	ø12	ø10	ø12
	Inch size	ø1/8"	ø5/32"	ø1/4"	ø5/32"	ø1/4"	ø1/4"	ø5/16"	ø1/4"	ø5/16"	ø3/8"	—	ø3/8"	ø1/2"
C values: Sonic conductance dm ³ /(s·bar)	Free flow	0.3	0.4	0.6	0.4	0.6	1.0	1.2	1.1	1.6	2.2	2.6	2.4	3.5
	Controlled flow	0.3			0.4	0.6	1.0	1.2	1.3	1.9	2.7	3.3	2.8	4.1
b values: Critical pressure ratio	Free flow	0.3	0.2		0.3	0.1	0.2		0.2			0.3	0.2	
	Controlled flow	0.2	0.3	0.4	0.2		0.2	0.3	0.1		0.2	0.1	0.2	

Flow Direction Symbol on Body

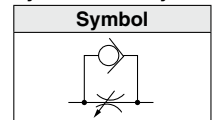

* C and b values are for controlled flow with the needle fully open and free flow with the needle fully closed.

How to Order

AS **200** **2** **F** **G** - **06** **A** - **□**

Body size

100	M5 standard
200	1/8 standard
205	1/4 standard
300	3/8 standard
400	1/2 standard

With One-touch fittings

Stainless steel type
(Stainless steel 303)

* The material can be visually identified by color of the release button.
Stainless steel type: White

* White is also used for inch size.

Made to Order

Push-lock type

Applicable tubing O.D.*1

Metric size		Inch size	
23	ø3.2*2	01	ø1/8"
04	ø4	03	ø5/32"
06	ø6	07	ø1/4"
08	ø8	09	ø5/16"
10	ø10	11	ø3/8"
12	ø12	13	ø1/2"

*1 For selecting applicable tubing O.D., refer to the "Model" shown above.

*2 Use ø1/8" tubing.

Made to Order



Lubricant: Vaseline **-X12**

Example) AS2002FG-06A-X12

Grease-free (Seal: Fluorine-coated) + Restrictor (Without check valve) **-X21**

Example) AS2002FG-06A-X21

* Not particle-free

Restrictor (Without check valve) **-X214**

Example) AS2002FG-06A-X214

Clean Series **10-**

Example) 10-AS2002FG-06A

*1 Fluorine grease is used.

*2 The cleanliness class (ISO class) is 5.

Dimensions, flow rate characteristics and options are the same as standard product (brass needle guide).

AS-FG Series

Construction

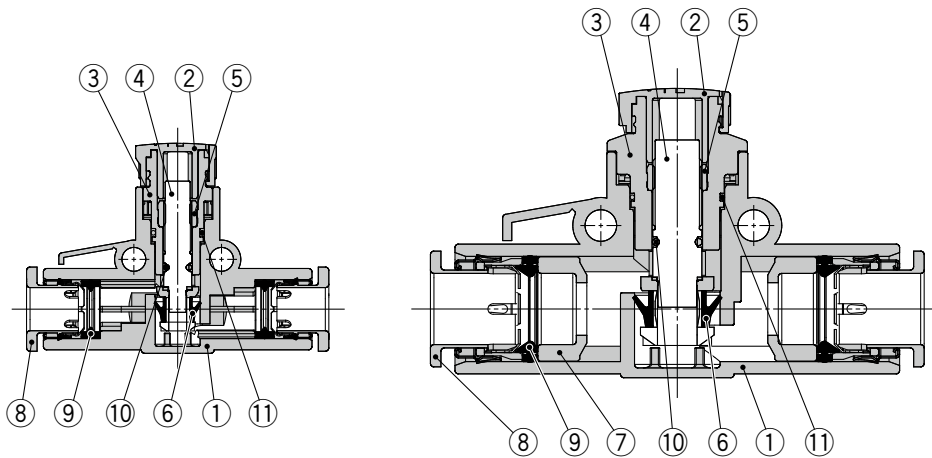

Component Parts

No.	Description	Material	Note
1	Body A	PBT	
2	Knob	POM	
3	Body B	PBT	
4	Needle	PBT	
5	Needle guide	Stainless steel 303	
6	U-seal	HNBR	
7	Spacer	PBT	
8	Cassette	—	
9	Seal	NBR	
10	O-ring	NBR	
11	O-ring	NBR	

L-Bracket

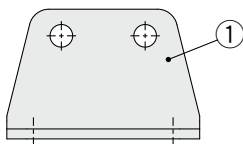

Component Parts

No.	Description	Material
1	Bracket	Steel strip

DIN Rail Mounting Bracket

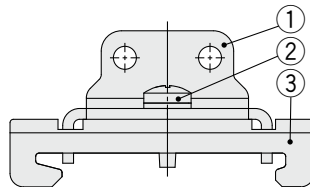

Component Parts

No.	Description	Material
1	Bracket	Steel strip
2	Cross recessed round head screw	Steel wire
3	Clasp	Steel strip

Related Equipment

Holder for Speed Controller TMH Series

A holder for securing a speed controller with One-touch fittings (In-line type)

Possible to hold a single controller

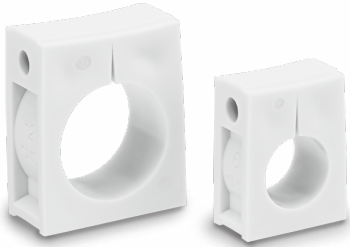

Holder mounting

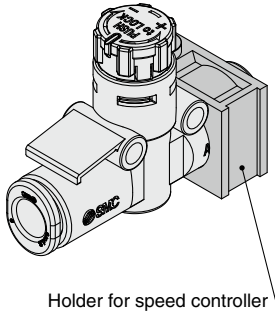

Holder for speed controller

Specifications

Ambient temperature	-20 to 60°C
Material	Polypropylene
Color	White

Accessory: Cross Recessed Round Head Screw for Mounting (Zinc chromated)

Part no.		Size (Nominal x Length)	Quantity
Metric size	Inch size		
TMH-23J	TMH-01J	M3 x 15	1
TMH-04J	TMH-03J		
TMH-06J	TMH-07J	M3 x 20	
TMH-06	TMH-07	M4 x 25	
TMH-08	TMH-09		
TMH-10	—	M4 x 35	
TMH-12	TMH-13		

Series

Select the applicable holder/TMH for each speed controller from the table below.

Metric Size

Tubing size	Applicable tubing					
	23	04	06	08	10	12
Applicable model	ø3.2	ø4	ø6	ø8	ø10	ø12
AS1002F□	TMH-23J	TMH-04J	TMH-06J			
AS2002F□						
AS2052F□			TMH-06	TMH-08		
AS3002F□			TMH-07			
AS4002F□					TMH-10	TMH-12 TMH-13

* The applicable TMH for the AS1002F□-02 is not available.

Inch Size

Tubing size	Applicable tubing					
	01	03	07	09	11	13
Applicable model	ø1/8"	ø5/32"	ø1/4"	ø5/16"	ø3/8"	ø1/2"
AS1002F□	TMH-01J	TMH-03J	TMH-07J			
AS2002F□						
AS2052F□						
AS3002F□			TMH-07	TMH-09		
AS4002F□					TMH-10	TMH-13

Dimensions

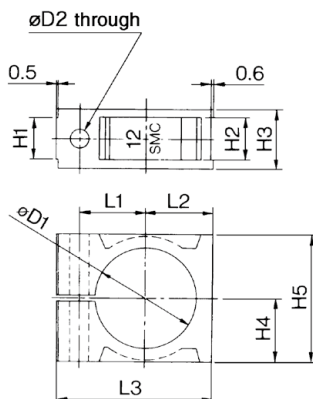



Part no.		øD1	øD2	H1	H2	H3	H4	H5	L1	L2	L3	Symbol
Metric size	Inch size											
TMH-23J	TMH-01J	8.5	3.3	4.5	4.6	7.5	6	12	7.2	6.6	18	1/8J
TMH-04J	TMH-03J	9.4										4 5/32J
TMH-06J	—	11.7	3.3	6.3	6.4	9.3	7.7	15.4	8.5	8.3	21	6J
—	TMH-07J	12.1										1/4J
TMH-06	—	13.1	4.3	7.1	7.2	11.1	10	20	11	10.6	26.5	6
—	TMH-07	13.5										1/4
TMH-08	TMH-09	15.5	4.3	9.5	9.6	13.5	14	28	14.2	14.6	34	8 5/16
TMH-10	—	18.8										10
TMH-12	—	21.2	4.3	9.5	9.6	13.5	14	28	14.2	14.6	34	12
—	TMH-13	22										1/2

Safety Instructions

These safety instructions are intended to prevent hazardous situations and/or equipment damage. These instructions indicate the level of potential hazard with the labels of “**Caution**,” “**Warning**” or “**Danger**.” They are all important notes for safety and must be followed in addition to International Standards (ISO/IEC)*1), and other safety regulations.

 **Caution:** **Caution** indicates a hazard with a low level of risk which, if not avoided, could result in minor or moderate injury.

 **Warning:** **Warning** indicates a hazard with a medium level of risk which, if not avoided, could result in death or serious injury.

 **Danger:** **Danger** indicates a hazard with a high level of risk which, if not avoided, will result in death or serious injury.

*1) ISO 4414: Pneumatic fluid power – General rules relating to systems.
ISO 4413: Hydraulic fluid power – General rules relating to systems.
IEC 60204-1: Safety of machinery – Electrical equipment of machines.
(Part 1: General requirements)
ISO 10218-1: Manipulating industrial robots – Safety.
etc.

Warning

1. The compatibility of the product is the responsibility of the person who designs the equipment or decides its specifications.

Since the product specified here is used under various operating conditions, its compatibility with specific equipment must be decided by the person who designs the equipment or decides its specifications based on necessary analysis and test results. The expected performance and safety assurance of the equipment will be the responsibility of the person who has determined its compatibility with the product. This person should also continuously review all specifications of the product referring to its latest catalog information, with a view to giving due consideration to any possibility of equipment failure when configuring the equipment.

2. Only personnel with appropriate training should operate machinery and equipment.

The product specified here may become unsafe if handled incorrectly. The assembly, operation and maintenance of machines or equipment including our products must be performed by an operator who is appropriately trained and experienced.

3. Do not service or attempt to remove product and machinery/equipment until safety is confirmed.

1. The inspection and maintenance of machinery/equipment should only be performed after measures to prevent falling or runaway of the driven objects have been confirmed.
2. When the product is to be removed, confirm that the safety measures as mentioned above are implemented and the power from any appropriate source is cut, and read and understand the specific product precautions of all relevant products carefully.
3. Before machinery/equipment is restarted, take measures to prevent unexpected operation and malfunction.

4. Contact SMC beforehand and take special consideration of safety measures if the product is to be used in any of the following conditions.

1. Conditions and environments outside of the given specifications, or use outdoors or in a place exposed to direct sunlight.
2. Installation on equipment in conjunction with atomic energy, railways, air navigation, space, shipping, vehicles, military, medical treatment, combustion and recreation, or equipment in contact with food and beverages, emergency stop circuits, clutch and brake circuits in press applications, safety equipment or other applications unsuitable for the standard specifications described in the product catalog.
3. An application which could have negative effects on people, property, or animals requiring special safety analysis.
4. Use in an interlock circuit, which requires the provision of double interlock for possible failure by using a mechanical protective function, and periodical checks to confirm proper operation.

Caution

1. The product is provided for use in manufacturing industries.

The product herein described is basically provided for peaceful use in manufacturing industries.
If considering using the product in other industries, consult SMC beforehand and exchange specifications or a contract if necessary.
If anything is unclear, contact your nearest sales branch.

Limited warranty and Disclaimer/ Compliance Requirements

The product used is subject to the following “Limited warranty and Disclaimer” and “Compliance Requirements”.

Read and accept them before using the product.

Limited warranty and Disclaimer

1. The warranty period of the product is 1 year in service or 1.5 years after the product is delivered, whichever is first.*2)
Also, the product may have specified durability, running distance or replacement parts. Please consult your nearest sales branch.
2. For any failure or damage reported within the warranty period which is clearly our responsibility, a replacement product or necessary parts will be provided.
This limited warranty applies only to our product independently, and not to any other damage incurred due to the failure of the product.
3. Prior to using SMC products, please read and understand the warranty terms and disclaimers noted in the specified catalog for the particular products.

*2) Vacuum pads are excluded from this 1 year warranty.

A vacuum pad is a consumable part, so it is warranted for a year after it is delivered.
Also, even within the warranty period, the wear of a product due to the use of the vacuum pad or failure due to the deterioration of rubber material are not covered by the limited warranty.

Compliance Requirements

1. The use of SMC products with production equipment for the manufacture of weapons of mass destruction (WMD) or any other weapon is strictly prohibited.
2. The exports of SMC products or technology from one country to another are governed by the relevant security laws and regulations of the countries involved in the transaction. Prior to the shipment of a SMC product to another country, assure that all local rules governing that export are known and followed.

Caution

SMC products are not intended for use as instruments for legal metrology.

Measurement instruments that SMC manufactures or sells have not been qualified by type approval tests relevant to the metrology (measurement) laws of each country. Therefore, SMC products cannot be used for business or certification ordained by the metrology (measurement) laws of each country.

Revision History

Edition B * “Made to Order” section has been added.
* Errors in text have been corrected.

WQ

Safety Instructions

Be sure to read the “Handling Precautions for SMC Products” (M-E03-3) and “Operation Manual” before use.