

Cylinder with Lock

CLS Series

ø125, ø140, ø160, ø180, ø200, ø250

A locking cylinder ideal for intermediate stops, emergency stops and drop prevention.



Series Variations

Series	Action	Type	Standard variations	Bore size (mm)	Lock holding force (kN)	Maximum stroke (mm)
			With rod boot			
Cylinder with lock CLS series	Double acting	Single rod CLS series	●	125	8.4	Maximum 1600
				140	10.5	
				160	13.8	
				180	17.4	Maximum 2000
				200	21.5	
	250	33.6	Maximum 2400			

- CLJ2
- CLM2
- CLG1
- CL1
- MLGC
- CNG
- MNB
- CNA2
- CNS
- CLS**
- CLQ
- RLQ
- MLU
- MLGP
- ML1C

- D-
- X

A locking cylinder ideal emergency stops and

Manual unlocking function

Even if the air supply is cut off or discharged, the lock can be released by screwing in the manual release bolt (hexagon socket head cap screw).

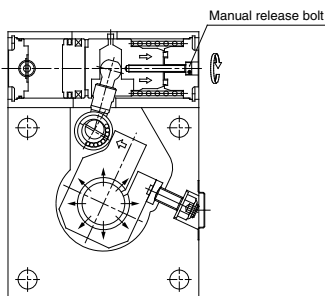

Design minimizes influences of unlocking air quality

A design largely unaffected by factors such as moisture and drainage in compressed air has been realized by separating the lock mechanism and the brake cylinder.

Can be locked in both directions

An equal holding force can be obtained on either reciprocating stroke of the cylinder.

Short body lock unit

Overall length has been reduced by using an independent brake cylinder (-15% compared to previous series). Weight reduction has also been realized through parts simplification (max. -40% compared to previous series).

Cylinder with Lock

CLS Series

Ø125, Ø140, Ø160,
Ø180, Ø200, Ø250

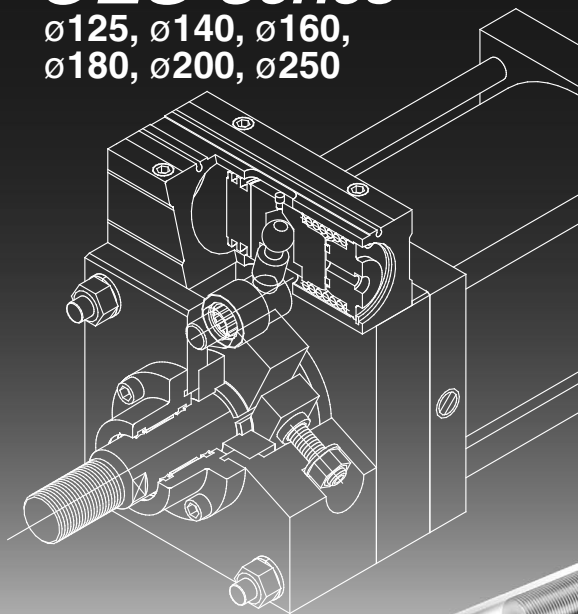

Steady holding force

Outstanding durability and steady holding force are maintained by using a brake shoe with superior wear resistance.

for intermediate stops, drop prevention.

Lock unit switch

By providing a switch on the brake cylinder, the operating state of the lock unit (brake piston) can be detected using the switch signal.

Lock unit

Small auto switches are mountable.

Small auto switches can also be mounted on the cylinder unit.

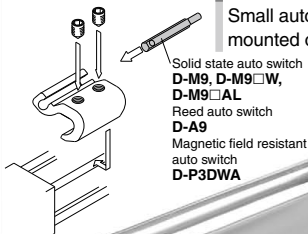

Fail safe construction

Since the mechanism locks when air pressure is exhausted, safe operation is possible even when there is a failure in the air supply or power supply, etc.

Construction principle

Uses an energizing mechanism based on the wedge effect of the eccentric cam shaft and the lever principle of the shoe holder.

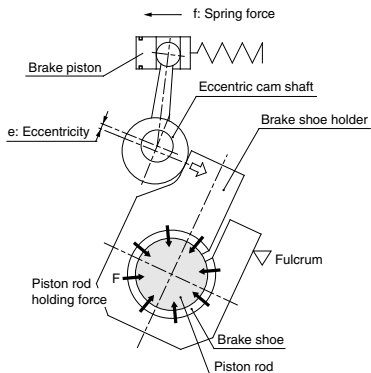

Maintenance simplified

The lock monitor makes it possible to confirm the operating state of the lock unit (brake piston) and the state of wear for each part, providing a guide for maintenance.

CLJ2

CLM2

CLG1

CL1

MLGC

CNG

MNB

CNA2

CNS

CLS

CLQ

RLQ

MLU

MLGP

ML1C

D-□

-X□

CLS Series Model Selection

Caution on Model Selection

⚠ Caution

- In order that the originally selected maximum speed is not exceeded, be certain to use a speed controller and adjust it so that movement through the total movement distance of the load takes place in no less than the applicable movement time. The movement time is the time that is necessary for the load to travel the total movement distance from the start without any intermediate stops.
- In cases where the cylinder stroke and the movement distance of the load are different (double speed mechanism, etc.), use the movement distance of the load for selection purposes.
Example)

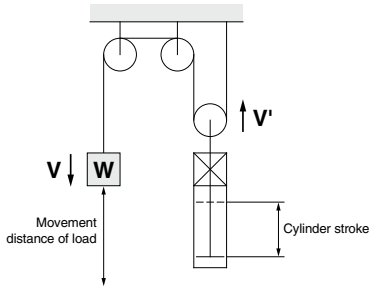

- Shown below is an example of a model selection procedure for an intermediate stop application (including an emergency stop in operation). Only when locking in a drop prevention application, when no kinetic energy is applied, the maximum load mass should be determined by using graphs 5 through 7 on page 981 (taking into consideration the upper limit of the load mass at a maximum speed of 100 mm/s).

Selection Example

- Load mass: $m = 320$ kg
- Movement distance: $st = 400$ mm
- Movement time: $t = 2$ s
- Load condition: Vertical downward = Load in direction of rod extension
- Operating pressure: $P = 0.4$ MPa

Step 1: From graph 1 find the maximum movement speed of the load
 \therefore Maximum speed V : approx. 280 mm/s

Step 2: Select Graph 6 based upon the load condition and operating pressure, and then from the intersection of the maximum speed $V = 280$ mm/s found in Step 1, and the load mass $m = 320$ kg
 $\therefore \phi 140 \rightarrow$ select a CLS140 or larger bore size.

Step 1 Find the maximum load speed: V .

Find the maximum load speed: V (mm/s) from the load movement time: t (s) and the movement distance: st (mm).

Graph 1

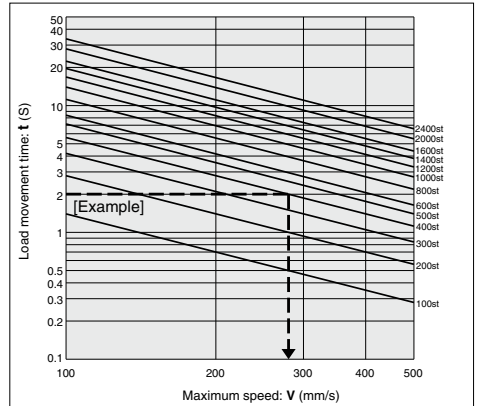

Step 2 Find the cylinder bore size.

Select a graph based upon the load condition and operating pressure, and then find the point of intersection for the maximum speed found in Step 1 and the load mass. Select the bore size on the line above the point of intersection.

Load condition

Direction of load at right angle to rod
 (* Being held by a guide)

Operating pressure

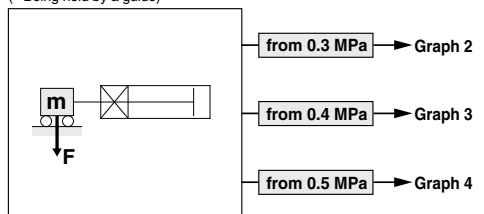

Load in direction of rod extension
 Load in direction of rod retraction

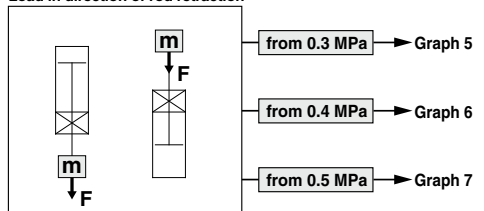

Selection Graph

Graph 2 $0.3 \text{ MPa} \leq P < 0.4 \text{ MPa}$

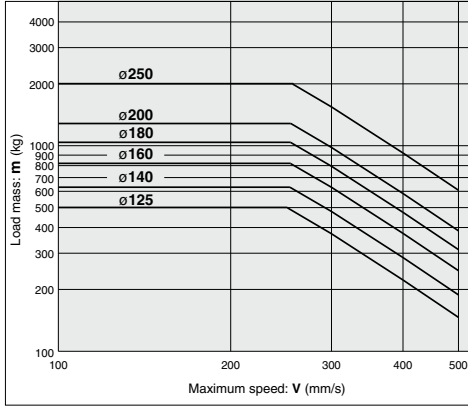

Graph 5 $0.3 \text{ MPa} \leq P < 0.4 \text{ MPa}$

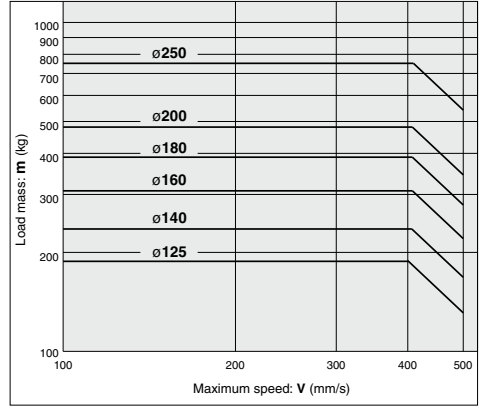

Graph 3 $0.4 \text{ MPa} \leq P < 0.5 \text{ MPa}$

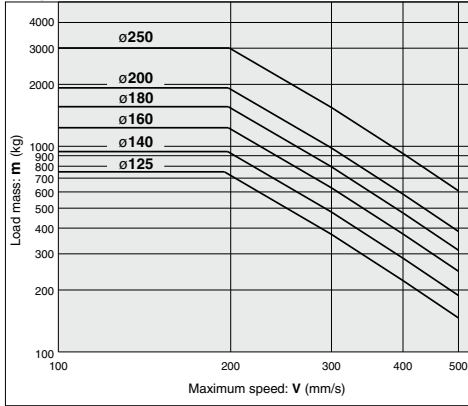

Graph 6 $0.4 \text{ MPa} \leq P < 0.5 \text{ MPa}$

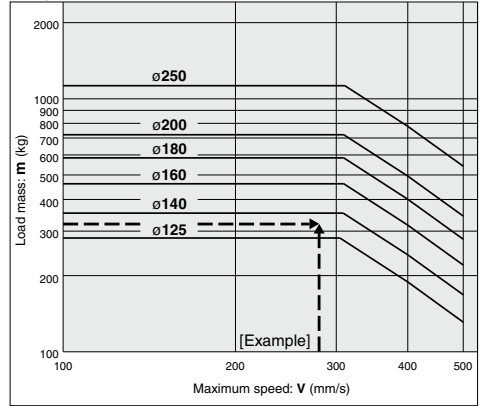

Graph 4 $0.5 \text{ MPa} \leq P$

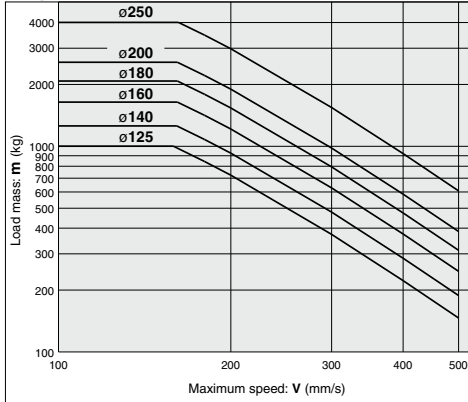

Graph 7 $0.5 \text{ MPa} \leq P$

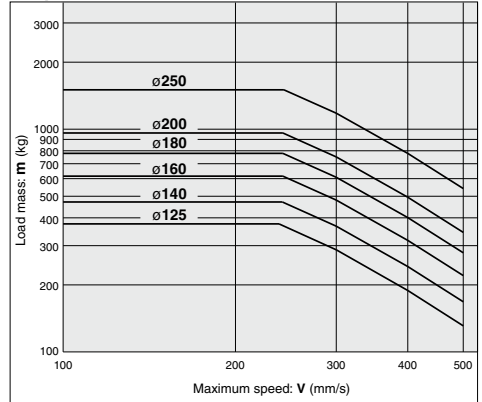

- CLJ2
- CLM2
- CLG1
- CL1
- MLGC
- CNG
- MNB
- CNA2
- CNS
- CLS
- CLQ
- RLQ
- MLU
- MLGP
- ML1C

- D-
- X

Cylinder with Lock Double Acting, Single Rod

CLS Series

∅125, ∅140, ∅160, ∅180, ∅200, ∅250

How to Order

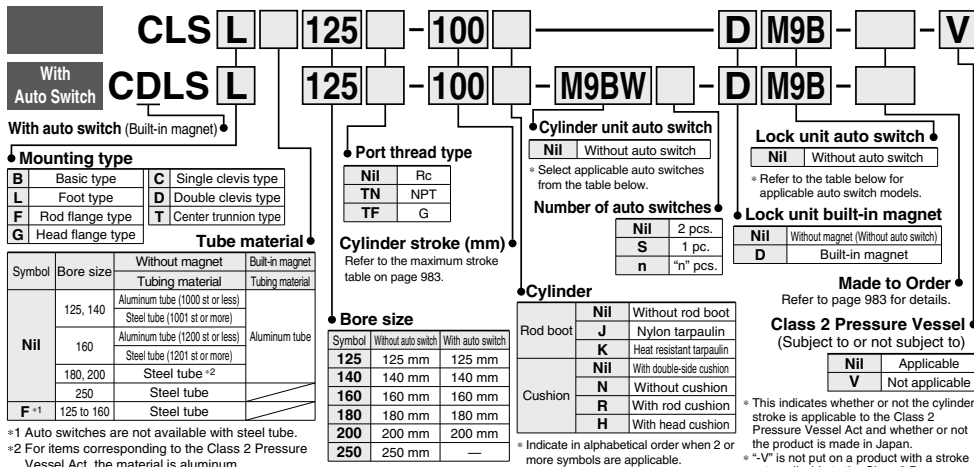

*1 Auto switches are not available with steel tube.
 *2 For items corresponding to the Class 2 Pressure Vessel Act, the material is aluminum.

Cylinder Unit/Applicable Auto Switches

Refer to pages 1119 to 1245 for detailed auto switch specifications.

Type	Special function	Electrical entry	Wiring (output)	Load voltage		Auto switch model		Lead wire length (m)					Pre-wired connector	Applicable load	
				DC	AC	Tie-rod mounting	Band mounting	0.5 (Nil)	1 (M)	3 (L)	5 (Z)				
Solid state auto switch	—	Grommet	3-wire (NPN)	24 V	5 V, 12 V	—	M9N	●	●	●	○	○	○	IC circuit	Relay, PLC
			3-wire (PNP)				●	●	●	○	○				
		2-wire	12 V	—	—	—	—	—	—	—	—	—			
		Terminal conduit	3-wire (NPN)	24 V	12 V	—	G39	—	—	—	—	—	—	—	
	2-wire	—	—				—	—	—	—	—	—			
	With diagnostic output (2-color indicator)	Grommet	3-wire (NPN)	24 V	5 V, 12 V	—	M9NW	●	●	●	○	○	○	IC circuit	
			3-wire (PNP)				●	●	●	○	○				
	Water resistant (2-color indicator)	Grommet	3-wire (NPN)	24 V	5 V, 12 V	—	M9NA *1	—	○	○	●	○	○	—	
			3-wire (PNP)				—	○	○	●	○				
	With diagnostic output (2-color indicator)	Grommet	4-wire (NPN)	24 V	5 V, 12 V	—	M9PA *1	—	○	○	●	○	○	IC circuit	
2-wire (Non-polar)			—				—	—	—	—	—	—	—		
Reed auto switch	—	Grommet	3-wire (NPN equiv.)	24 V	5 V	—	A96	—	●	—	—	—	—	IC circuit	Relay, PLC
			2-wire				12 V	100 V	A93	—	●	●	●		
		Terminal conduit	Yes	2-wire	24 V	5 V, 12 V	100 V or less	A90	—	●	—	—	—	IC circuit	
								100 V, 200 V	A54	—	●	—	—		
	DIN terminal	Yes	2-wire	24 V	12 V	100 V, 200 V	—	A33	—	—	—	—	—		
							—	A34	—	—	—	—			
	Grommet	Yes	2-wire	24 V	12 V	100 V, 200 V	—	A44	—	—	—	—	—		
							—	A59W	—	●	—	—		—	

*1 Water resistant type auto switches can be mounted on the above models, but in such case SMC cannot guarantee water resistance.

Consult with SMC regarding water resistant types with the above model numbers.

* Lead wire length symbol: 0.5 m Nil (Example) M9NW
 1 m M (Example) M9NWM
 3 m L (Example) M9NWL
 5 m Z (Example) M9NWZ

* Solid state auto switches marked with "○" are produced upon receipt of order.

* There are applicable auto switches other than listed above. For details, refer to page 998.

* For details about auto switches with pre-wired connector, refer to pages 1192 and 1193.

* D-A9□/M9□/M9□W/M9□A/P3DWA□ auto switches are shipped together (not assembled).

(Only auto switch brackets are assembled at the time of shipment.)

Lock Unit/Applicable Auto Switches

Auto switch type	Special function	Electrical entry	Wiring (output)	Load voltage		Auto switch model	Lead wire length (m)					Applicable load	
				DC	AC		0.5 (Nil)	1 (M)	3 (L)	5 (Z)			
Solid state	Grommet	Yes	3-wire (NPN) 3-wire (PNP)	24 V	5 V, 12 V	—	M9N	●	●	●	○	IC circuit	Relay, PLC
							M9P	●	●	●	○		
							M9B	●	●	●	○		
Reed	—	No	2-wire	24 V	5 V, 12 V	100 V or less	A90	●	●	●	—	IC circuit	Relay, PLC
							A93	●	●	●	—		

*D-A9□/M9□ auto switches are shipped together (not assembled).



Made to Order
[Click here for details](#)

Symbol	Specifications
-XA□	Change of rod end type
-XC3	Special port location
-XC14	Change of trunnion bracket mounting position (125, 140, 160 only)
-XC35	With coil scraper (125, 140, 160 only)*

* ø180 to ø250 come with a coil scraper as standard.

Stopping Accuracy

Lock type	Piston speed (mm/s)		
	100	300	500
Spring lock	±0.5	±1.0	±2.0

Conditions:
Horizontal, Supply pressure P = 0.5 MPa
Load mass Upper limit of allowed value
Solenoid valve for locking ... Mounted directly to unlocking port
Maximum value from range of 100 measured stopping positions

Class 2 Pressure Vessel

A Class 2 Pressure Vessel will be required for strokes exceeding those shown below.

Bore size (mm)	Cylinder stroke (mm)
180	1569
200	998
250	813

Refer to pages 995 to 998 for cylinders with auto switches.

- Minimum auto switch mounting stroke
- Proper auto switch mounting position (detection at stroke end) and mounting height
- Operating range
- Switch mounting bracket: Part no.

Rod Boot Material

Symbol	Material	Max. ambient temperature
J	Nylon tarpaulin	20°C
K	Heat resistant tarpaulin	110°C*

* Maximum ambient temperature for the rod boot itself.

Cylinder Specifications

Bore size (mm)	125	140	160	180	200	250
Type	Not required (Non-lube)					
Fluid	Air					
Proof pressure	1.57 MPa, 1.2 MPa*					
Max. operating pressure	0.97 MPa, 0.7 MPa*					
Min. operating pressure	0.08 MPa					
Piston speed	50 to 500 mm/s**					
Cushion	Yes					
Ambient and fluid temperature	Without auto switch: 0°C to 70°C With auto switch: 0°C to 60°C (with no freezing)					
Stroke length tolerance	to 250: $^{+1.0}_0$, 251 to 1000: $^{+1.4}_0$, 1001 to 1500: $^{+1.8}_0$, 1501 to 2000: $^{+2.0}_0$, 2001 to 2400: $^{+2.5}_0$					
Mounting	Basic type, Foot type, Rod flange type, Head flange type, Single clevis type, Double clevis type, Center trunnion type					

* For ø180 and ø200 with auto switches.

** There are load limitations depending on the piston speed when locked, the mounting method, and the operating pressure.

Lock Specifications

Bore size (mm)	125	140	160	180	200	250
Locking action	Spring locking (exhaust locking)					
Unlocking pressure	0.25 MPa or more					
Locking pressure	0.20 MPa or less					
Max. operating pressure	1.0 MPa					
Locking direction	Both directions					
Holding force (max. static load) kN†	8.4	10.5	13.8	17.4	21.5	33.6

† The holding force (max. static load) shows the maximum capability and does not show the normal holding capability. So, select an appropriate cylinder while referring to page 980.

Cylinder Stroke

Tube material	Aluminum alloy			Carbon steel tube		
	Bore size (mm)	Basic type, Head flange type, Single clevis type, Double clevis type, Center trunnion type, Foot type, Rod flange type	Basic type, Head flange type, Single clevis type, Double clevis type, Center trunnion type	Foot type Rod flange type		
125, 140	1000 or less	1000 or less	1600 or less			
160	1200 or less	1200 or less	1600 or less			
180	—	1200 or less	2000 or less			
200	—	1200 or less ^{Note)}	2000 or less			
250	—	1200 or less	2400 or less			

Note) The tubing material of items with a bore size of 180 and 200 corresponding to the Class 2 Pressure Vessel Act is aluminum tubing.

Cylinder Stroke/Auto Switch Mounting on Cylinder Unit (Built-in Magnet)

Refer to the minimum auto switch mounting stroke (page 996) for those with an auto switch.

Bore size (mm)	Basic type, Head flange type, Single clevis type, Double clevis type, Center trunnion type		Foot type Rod flange type
	125, 140	160	
125, 140	1000 or less	1400 or less	
160	1200 or less	1400 or less	
180	1200 or less	1500 or less	
200	998 or less	998 or less	
Note	For ø200, 998 to 1200 strokes are available as made to order.	For ø200, 998 to 1500 strokes are available as made to order.	

Mounting Bracket Part No.

Bore size (mm)	125	140	160	180	200	250
Foot type ^{Note 1)}	CS1-L12	CS1-L14	CS1-L16	CS1-L18	CS1-L20	CS1-L25
Rod flange type ^{Note 2)}	CS1-FL12	CS1-FL14	CS1-FL16	CS1-FL18	CS1-FL20	CS1-FL25
Head flange type	CS1-F12	CS1-F14	CS1-F16	CS1-F18	CS1-F20	CS1-F25
Single clevis type	CS1-C12	CS1-C14	CS1-C16	CS1-C18	CS1-C20	CS1-C25
Double clevis ^{Note 3)}	CS1-D12	CS1-D14	CS1-D16	CS1-D18	CS1-D20	CS1-D25

Note 1) When ordering foot brackets, 2 pcs. should be ordered for each cylinder.

Note 2) ø125 to ø250 front flange types use CS1 series long stroke flanges.

Note 3) A clevis pin and cotter pins (2 pcs.) are packed with the double clevis type.

CLJ2

CLM2

CLG1

CL1

MLGC

CNG

MNB

CNA2

CNS

CLS

CLQ

RLQ

MLU

MLGP

MLTC

D-□

-X□

Accessories

Mounting brackets	Basic type	Foot type	Rod flange type	Head flange type	Single clevis type	Double clevis type	Center trunnion type
Standard equipment	Clevis pin	—	—	—	—	●	—
Options	Rod end nut	●	●	●	●	●	●
	Single knuckle joint	●	●	●	●	●	●
	Double knuckle joint (with pin)	●	●	●	●	●	●
	With rod boot	●	●	●	●	●	●

* Refer to the accessory models and dimensions on page 993.

** Refer to page 994 when the rod end nut, and the single and double knuckle joints are used together.

Weight/Numbers inside () are for steel tube

Unit: kg

Bore size (mm)	125	140	160	180	200	250	
Lock unit weight	9.40	11.37	16.93	26.20	36.4	61.70	
Basic weight	Basic type	23.49 (24.96)	28.30 (30.11)	40.87 (43.08)	57.30 (63.91)	75.46 (82.01)	— (138.94)
		Foot type	25.12 (26.59)	30.82 (32.63)	43.67 (45.88)	61.50 (68.11)	80.34 (86.89)
	Flange type	26.17 (27.64)	33.30 (35.11)	47.26 (49.47)	67.13 (73.74)	87.37 (93.92)	— (160.78)
		Single clevis type	26.56 (28.03)	32.59 (34.40)	46.36 (48.57)	65.69 (72.30)	85.36 (91.91)
	Double clevis type (includes clevis pin & cotter pin)	27.02 (28.49)	33.34 (35.15)	47.21 (49.42)	67.37 (73.98)	87.39 (93.94)	— (160.52)
	Center trunnion type	27.62 (29.09)	34.03 (35.84)	48.27 (50.48)	68.46 (75.07)	89.45 (96.00)	— (166.78)
	Additional weight per 100 mm of stroke	1.77 (2.66)	1.96 (3.01)	2.39 (3.58)	2.85 (4.95)	3.42 (5.75)	— (9.08)
Accessories	Single knuckle	0.91	1.16	1.56	3.07	2.90	5.38
	Double knuckle (with pin)	1.37	1.81	2.48	4.74	4.59	9.22
	Rod end nut	0.16	0.16	0.23	0.33	0.56	1.01

Calculation (Ex.) CLSL140-100 Basic weight 30.82 (foot type, ϕ 140)
 Additional weight 1.96/100 mm stroke
 Cylinder stroke 100 mm stroke
 $30.82 + 1.96 \times 100/100 = 32.78$ kg

Regulations/Class 2 Pressure Vessel Act

The air cylinder uses the compressed air, but may become applicable to the regulations depending on the cylinder size. So, please fully understand the regulations before using the cylinder.

Regulations regarding Class 2 Pressure Vessel

1. As specified in Articles 42 and 44 of the Industrial Safety and Health Act, the individual examination shall be conducted in conformity with the Class 2 Pressure Vessel Act. If the pressure vessel structure does not satisfy the Class 2 Pressure Vessel Act, it shall not be transferred, leased or installed.

2. About Class 2 Pressure Vessel

The Class 2 Pressure Vessel is a vessel (except for Class 1 Pressure Vessel) that contains the gas with a gauge pressure of 0.2 MPa or more and satisfies the conditions shown below.

① Vessel with an inside capacity of 0.04 m³ or more

② Vessel with a shell inside diameter of 200 mm or more and a length of 1000 mm or more (extracted from Article 1-7 of the Industrial Safety and Health Act.)

The following shows SMC products that are applicable to the Class 2 Pressure Vessel Act.

Products applicable to the Class 2 Pressure Vessel Act

If the stroke exceeds the level shown below, the cylinder is applicable to the Class 2 Pressure Vessel Act.

Bore size (mm)	Cylinder stroke (mm)
180	1569
200	998
250	813
300	564

3. Periodical Self Inspection

As specified in Article 45 of the Industrial Safety and Health Act, it is obligated to conduct the periodical self inspection of the product applicable to the Class 2 Pressure Vessel Act and keep the inspection records when using it. (Related laws: Articles 88 and 89 of the Ordinance on Safety of Boilers and Pressure Vessels) After the use of the product applicable to the Class 2 Pressure Vessel Act has been started, the self inspection of the following points is conducted once a year and the inspection results are recorded.

- 1 Check the main body for damage.
- 2 Check the lid tightening bolt for wear.
- 3 Check the pipe and valve for damage.

4. Products not applicable to the Class 2 Pressure Vessel Act

According to Articles 13 and 14 of the Industrial Safety and Health Act, when it is obvious that the product is not used in Japan, it is not necessary to examine the product in conformity with the Class 2 Pressure Vessel Act. Additionally, when it is obvious that the product is not used in Japan, the product is exempted from the machine applicable to Articles 42 and 44 of the Industrial Safety and Health Act.

Please order the air cylinder with "V" put at the end of the part number.

(The symbol "V" is not put on a product with a stroke not applicable to the Class 2 Pressure Vessel Act.)

The cylinders manufactured in SMC overseas factories are not examined in conformity with the Class 2 Pressure Vessel Act. When using the cylinder in Japan, be sure to use the cylinder made in Japan that has been examined in conformity with the Class 2 Pressure Vessel Act.

5 A safety valve is installed on the upstream side of the piping so that any pressure exceeding the maximum operating pressure of the cylinder applicable to the Class 2 Pressure Vessel Act is not applied.

Construction Principle

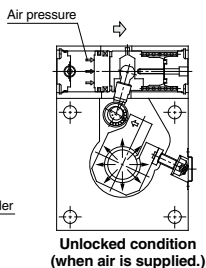
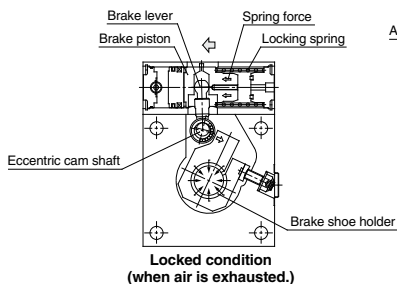

Spring locking (exhaust locking)

The brake piston actuated by the force of the spring turns the eccentric cam shaft via the brake holder due. This turning force distorts the brake shoe holder due to the wedge effect of the cam, acting on the brake shoe and locking the piston rod by tightening on it with a large force.

Unlocking occurs when air pressure is supplied to the unlocking port, causing the brake piston to counteract the force of the spring and push the brake lever back. This removes the force which is distorting the shoe holder and unlocks the piston rod.

Cylinder with Lock Double Acting, Single Rod **CLS Series**

Construction

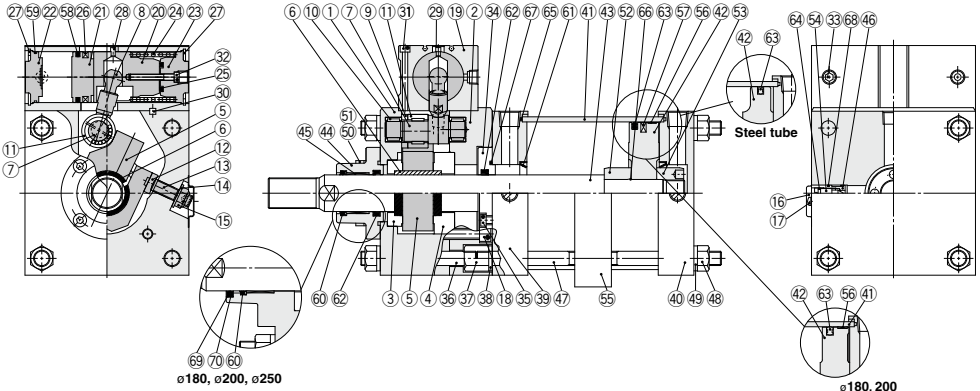

Component Parts

No.	Description	Material	Note
1	Cover A	Aluminum alloy	Black hard anodized (ø125, ø140, ø160) Hard anodized & coated (ø180, ø200, ø250)
2	Cover B	Aluminum alloy	Black hard anodized (ø125, ø140, ø160) Hard anodized & coated (ø180, ø200, ø250)
3	Thrust washer A	Carbon steel	Electroless nickel plated (ø125, ø140, ø160) Special treatment (ø180, ø200, ø250)
4	Thrust washer B	Carbon steel	Electroless nickel plated (ø125, ø140, ø160)
5	Brake shoe holder A	Chromium molybdenum steel	Special treatment
6	Brake shoe	Special friction material	
7	Eccentric cam shaft	Special steel	
8	Brake lever	Chromium molybdenum steel	Zinc chromated
9	Washer	Carbon steel	Zinc chromated
10	Needle bearing	—	
11	Needle bearing	—	
12	Stopper	Special steel	Electroless nickel plated
13	Adjustment screw	Chromium molybdenum steel	Zinc chromated
14	Conical spring washer	Spring steel	
15	U nut	Carbon steel	
16	Cover	Steel plate	Black zinc chromated
17	Cover holding screw	Carbon steel	
18	Cover holding bolt	Chromium molybdenum steel	
19	Brake tube	Aluminum alloy	Clear hard anodized
20	Brake piston A	Carbon steel	Nitriding
21	Brake piston B	Aluminum alloy	Chromated
22	Bottom plate	Aluminum alloy	Black anodized
23	Spring collar	Aluminum alloy	Black anodized
24	Brake spring	Steel wire	Zinc chromated
25	Bumper B	Polyurethane rubber	
26	Magnet	—	(Built-in magnet for lock unit)
27	Retaining ring	Carbon tool steel	Phosphate coated
28	Marker	Resin	White
29	Trim plate	Resin	
30	Key	Carbon steel	
31	Brake tube holding bolt	Chromium molybdenum steel	
32	Manual release bolt	Chromium molybdenum steel	
33	Plug with breathing hole	—	
34	Retaining plate B	Aluminum alloy	
35	Retaining plate holding bolt	Chromium molybdenum steel	
36	Unit holding tie-rod	Carbon steel	Chromated
37	Wing nut	Carbon steel	
38	Conical spring washer	Spring steel	
39	Rod cover	Rolled steel plate	Black coated
40	Head cover	Rolled steel plate	Black coated
41	Cylinder tube	Aluminum alloy Carbon steel pipe	Hard anodized (ø125 to ø200) Hard chrome plated (ø125 to ø250)

Component Parts

No.	Description	Material	Note
42	Piston	Aluminum alloy casting	In case of aluminum tube
43	Piston rod	Cast iron	In case of steel tube
44	Retaining plate	Cast iron	Black coated (ø125, ø140, ø160)
45	Bushing	Bearing alloy	
46	Valve guide	Brass	
47	Tie-rod	Carbon steel	Chromated
48	Tie-rod nut	Rolled steel plate	
49	Spring washer	Steel wire	
50	Retaining plate bolt	Chromium molybdenum steel	
51	Spring washer	Steel wire	
52	Cushion ring A	Rolled steel	Zinc chromated
53	Cushion ring B	Rolled steel	Zinc chromated
54	Cushion valve	Rolled steel	Electroless nickel plated
55	Tie-rod reinforcement ring	Rolled steel	Black coated (long stroke)
56	Wear ring	Resin	In case of aluminum tube
57	Magnet	—	For built-in magnet type
58	Piston seal	NBR	
59	Tube gasket	NBR	
60	Wiper ring	NBR	
61	Cushion seal	NBR	
62	Rod seal	NBR	
63	Piston seal	NBR	
64	Valve seal	NBR	
65	Tube gasket	NBR	
66	Piston gasket	NBR	
67	Retaining plate gasket	NBR	
68	Guide gasket	NBR	
69	Coil scraper	Phosphor bronze	(ø180, ø200, ø250)
70	Coil scraper holder	Aluminum alloy	Black anodized (ø180, ø200, ø250)

Replacement Parts: Seal Kit

Bore size (mm)	Order No.	Contents
125	CLS125-PS	A set of above Nos. 60, 62, 63, 64, 65 & 67
140	CLS140-PS	
160	CLS160-PS	
180	CLS180-PS	
200	CLS200-PS	
250	CLS250-PS	

* Since the lock section for CLS series is normally replaced as a unit, replacement seal kits are for the cylinder section only.

** Seal kits are sets consisting of items 60, 62, 63, 64, 65 and 67, which can be ordered using the order number for each cylinder bore size.

* Seal kit includes a grease pack (ø125 to ø160: 40 g, ø180, ø200: 50 g, ø250: 60 g).

Order with the following part number when only the grease pack is needed.
Grease pack part no.: GR-S-010 (10 g), GR-S-020 (20 g)

CLJ2

CLM2

CLG1

CL1

MLGC

CNG

MNB

CNA2

CNS

CLS

CLQ

RLQ

MLU

MLGP

ML1C

D-□

X-□

CLS Series

Dimensions

Basic type(B)

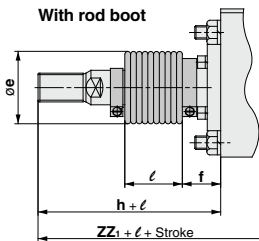
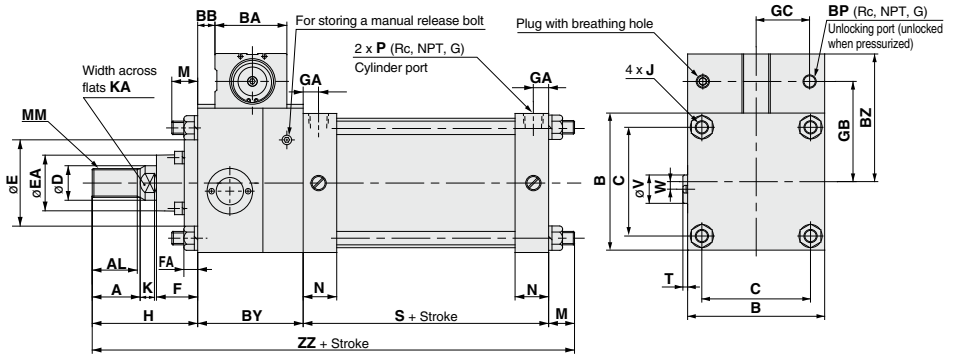
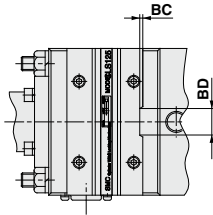

For $\phi 180, \phi 200, \phi 250$

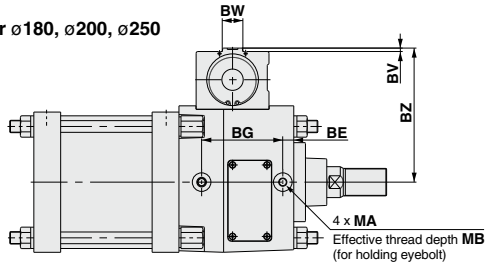

Bore size (mm)	Stroke range (mm)	(mm)																															
		A	AL	B	BA	BB	BC	BD	BE	BG	BY	BZ	BV	BW	BP	C	D	E	EA	F	FA	GA	GB	GC	H	J	K	KA	M	MM	MA	MB	N
125	Up to 1000	50	47	145	75	18	—	—	—	110	136	—	—	1/4	115	36	90	59	43	14	16	107	58	110	M14 x 1.5	15	31	27	M30 x 1.5	—	—	35	
140	Up to 1000	50	47	161	78	18	3	30	—	110	146	—	—	1/4	128	36	90	59	43	14	16	114	64	110	M14 x 1.5	15	31	27	M30 x 1.5	—	—	35	
160	Up to 1200	56	53	182	95	23	5	46	—	132	169	—	—	1/4	144	40	90	59	43	14	18.5	130	74	120	M16 x 1.5	17	36	30.5	M36 x 1.5	—	—	39	
180	Up to 1200	63	60	204	106	36	—	—	16	118	167	195	5	30	3/8	162	45	115	70	48	17	18.5	149	86	135	M18 x 1.5	20	41	35	M40 x 1.5	M12 x 1.75	25	39
200	Up to 1200	63	60	226	124	40.5	—	—	21	131	187	216	5.5	34	3/8	182	50	115	74	48	17	18.5	165	97	135	M20 x 1.5	20	46	35	M45 x 1.5	M16 x 2	31	39
250	Up to 1200	71	67	277	152	58	—	—	35	155	237	281.5	6	42	1/2	225	60	140	86	60	20	23	200	117	160	M24 x 1.5	25	56	41.5	M56 x 2	M20 x 2.5	41	49

(mm)						
Bore size (mm)	P	S	T	V	W	ZZ
125	1/2	98	5	30	—	345
140	1/2	98	5	30	8	345
160	3/4	106	5	30	9	388.5
180	3/4	111	—	—	—	448
200	3/4	111	—	—	—	468
250	1	141	—	—	—	578.5

With Rod Boot (mm)						
Bore size (mm)	Stroke range (mm)	e	f	h	ℓ	ZZ ₁
125	30 to 1000	75	40	133	0.2 stroke	368
140	30 to 1000	75	40	133	0.2 stroke	368
160	30 to 1200	75	40	141	0.2 stroke	409.5
180	30 to 1200	85	45	153	0.2 stroke	466
200	30 to 1200	90	45	153	0.2 stroke	486
250	30 to 1200	105	55	176	0.17 stroke	555.5

With Auto Switch (mm)				
Bore size (mm)	Stroke range (mm)	S	Without rod boot ZZ	With rod boot ZZ ₁
125	Up to 1000	98	345	368
140	Up to 1000	98	345	368
160	Up to 1200	106	388.5	409.5
180	Up to 1200	115	452	470
200	Up to 1200	120	477	495

Cylinder with Lock Double Acting, Single Rod **CLS Series**

Axial foot type(L)

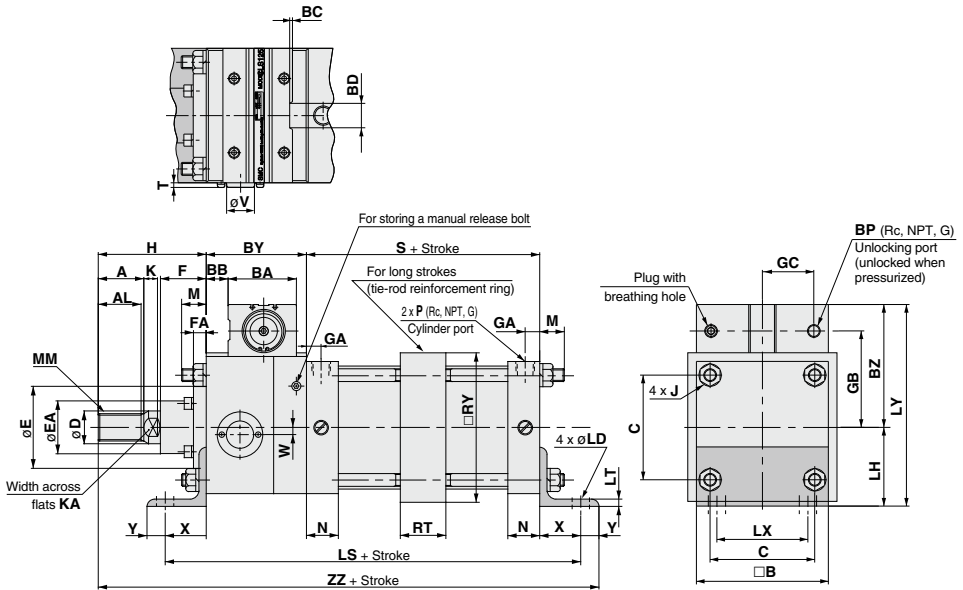

With rod boot

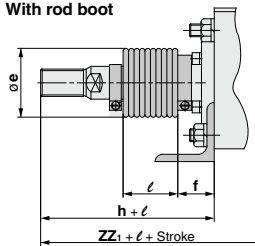

For ø180, ø200, ø250

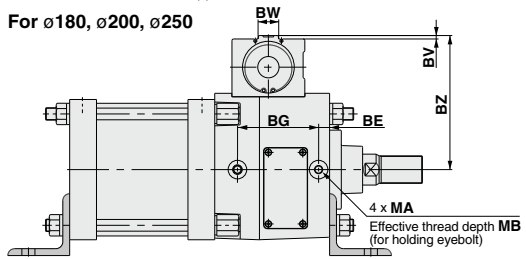

Bore size (mm)	Stroke range (mm)	Long stroke range (mm)	(mm)																																	
			A	AL	B	BAB	BC	BD	BE	BG	BY	BZ	BV	BW	BP	C	D	E	EA	F	FAG	AG	BGC	H	J	K	KAL	DH	LS	LT	LX	LY	M			
125	Up to 1400	1401 to 1600	50	47	145	75	18	—	—	—	110	136	—	—	1/4	115	36	90	59	43	14	16	107	58	110	M14 x 1.5	15	31	19	85	298	8	100	221	27	
140	Up to 1400	1401 to 1600	50	47	161	78	18	3	30	—	110	146	—	—	1/4	128	36	90	59	43	14	16	114	64	110	M14 x 1.5	15	31	19	100	298	9	112	266	27	
160	Up to 1400	1401 to 1600	56	53	182	95	23	5	46	—	132	169	—	—	1/4	144	40	90	59	43	14	18.5	130	74	120	M16 x 1.5	17	36	19	106	338	9	118	275	30.5	
180	Up to 1800	1801 to 2000	63	60	204	106	36	—	—	16	118	167	195	5	30	3/8	182	45	115	70	48	17	18.5	149	86	135	M18 x 1.5	20	41	24	125	398	10	132	301	35
200	Up to 1800	1801 to 2000	63	60	226	124	40.5	—	—	21	131	187	216	5.5	34	3/8	182	50	115	74	48	17	18.5	165	97	135	M20 x 1.5	20	46	24	132	418	10	150	348	35
250	Up to 2000	2001 to 2400	71	67	277	152	58	—	—	35	155	237	281.5	6	42	1/2	225	60	140	86	60	20	23	200	117	160	M24 x 1.5	25	56	29	160	538	12	180	421.5	41.5

Bore size (mm)	(mm)													
	MM	MA	MN	P	R	RY	S	T	V	W	X	Y	ZZ	
125	M30 x 1.5	—	—	35	1/2	36	164	98	5	30	—	45	20	383
140	M30 x 1.5	—	—	35	1/2	36	184	98	5	30	8	45	30	393
160	M36 x 1.5	—	—	39	3/4	45	204	106	5	30	9	50	25	433
180	M40 x 1.5	M12 x 1.75	25	39	3/4	45	228	111	—	—	—	60	30	503
200	M45 x 1.5	M16 x 2	31	39	3/4	45	257	111	—	—	—	60	30	523
250	M56 x 2	M20 x 2.5	41	49	1	55	325	141	—	—	—	80	40	658

With Rod Boot (mm)						
Bore size (mm)	Stroke range (mm)	e	f	h	l	ZZ1
125	30 to 1400	75	40	133	0.2 stroke	406
140	30 to 1400	75	40	133	0.2 stroke	416
160	30 to 1400	75	40	141	0.2 stroke	454
180	30 to 1800	85	45	153	0.2 stroke	521
200	30 to 1800	90	45	153	0.2 stroke	541
250	30 to 2000	105	55	176	0.17 stroke	674

With Auto Switch (mm)					
Bore size (mm)	Stroke range (mm)	S	LS	Without rod boot ZZ	With rod boot ZZ1
125	Up to 1400	98	298	383	406
140	Up to 1400	98	298	393	416
160	Up to 1400	106	338	433	454
180	Up to 1500	115	402	507	525
200	Up to 998	120	427	532	550

- CLJ2
- CLM2
- CLG1
- CL1
- MLGC
- CNG
- MNB
- CNA2
- CNS
- CLS**
- CLQ
- RLQ
- MLU
- MLGP
- ML1C

- D-□
- X□

CLS Series

Dimensions

Rod flange type (F)

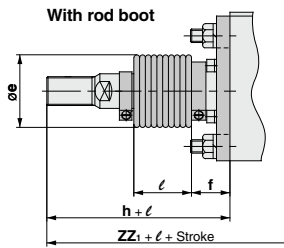
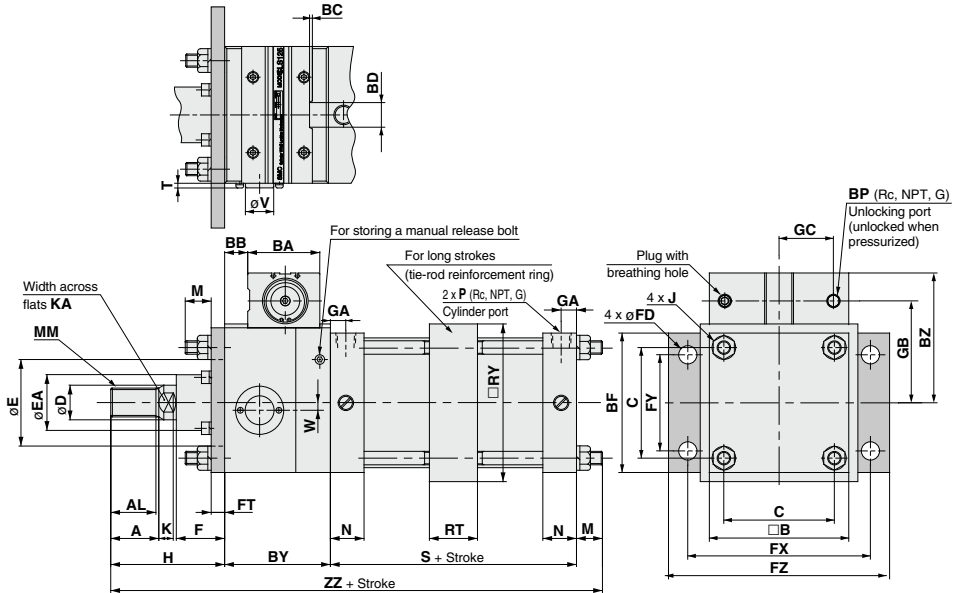

For ø180, ø200, ø250

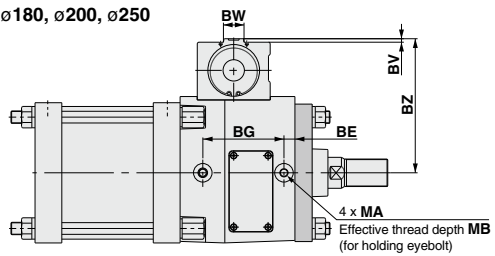

Bore size (mm)	Stroke range (mm)	Long stroke range (mm)	A	AL	B	BA	BB	BC	BD	BE	BG	BF	BV	BW	BP	C	D	E	EA	F	FD	FT	FX	FY	FZ	G	GAG	GB	GC	H	J	K	KA	M	
125	Up to 1400	1401 to 1600	50	47	145	75	18	—	—	—	145	110	136	—	1/4	115	36	90	59	43	19	14	190	100	230	16	107	58	110	M14 x 1.5	15	31	19		
140	Up to 1400	1401 to 1600	50	47	161	78	18	3	30	—	160	110	146	—	1/4	128	36	90	59	43	19	20	212	112	255	16	114	64	110	M14 x 1.5	15	31	19		
160	Up to 1400	1401 to 1600	56	53	182	95	23	5	46	—	180	132	169	—	1/4	144	40	90	59	43	19	20	236	118	275	18.5	130	74	120	M16 x 1.5	17	36	22		
180	Up to 1800	1801 to 2000	63	60	204	106	36	—	—	16	118	200	167	195	5	30	3/8	162	45	115	70	48	24	25	265	132	320	18.5	149	86	135	M18 x 1.5	20	41	26
200	Up to 1800	1801 to 2000	63	60	226	124	40.5	—	—	21	131	225	187	216	5.5	34	3/8	182	50	115	74	48	24	25	280	150	335	18.5	165	97	135	M20 x 1.5	20	46	26
250	Up to 2000	2001 to 2400	71	67	277	152	58	—	—	35	155	275	237	281.5	6	42	1/2	225	60	140	86	60	29	30	355	180	420	23	200	117	160	M24 x 1.5	25	56	30

Bore size (mm)	MM	MA	MB	N	P	RT	RS	S	T	V	W	ZZ
125	M30 x 1.5	—	—	35	1/2	36	164	98	5	30	—	337
140	M30 x 1.5	—	—	35	1/2	36	184	98	5	30	8	337
160	M36 x 1.5	—	—	39	3/4	45	204	106	5	30	9	380
180	M40 x 1.5	M12 x 1.75	25	39	3/4	45	228	111	—	—	—	439
200	M45 x 1.5	M16 x 2	31	39	3/4	45	257	111	—	—	—	459
250	M56 x 2	M20 x 2.5	41	49	1	55	325	141	—	—	—	588

Bore size (mm)	Stroke range (mm)	e	f	h	ℓ	ZZ ₁
125	30 to 1400	75	40	133	0.2 stroke	360
140	30 to 1400	75	40	133	0.2 stroke	360
160	30 to 1400	75	40	141	0.2 stroke	401
180	30 to 1800	85	45	153	0.2 stroke	457
200	30 to 1800	90	45	153	0.2 stroke	477
250	30 to 2000	105	55	176	0.17 stroke	584

Bore size (mm)	Stroke range (mm)	S	Without rod boot ZZ	With rod boot ZZ ₁
125	Up to 1400	98	337	360
140	Up to 1400	98	337	360
160	Up to 1400	106	380	401
180	Up to 1500	115	443	461
200	Up to 998	120	468	486

Head flange type/(G)

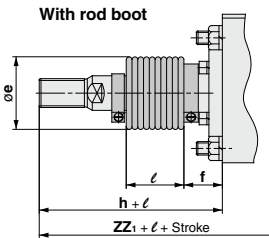
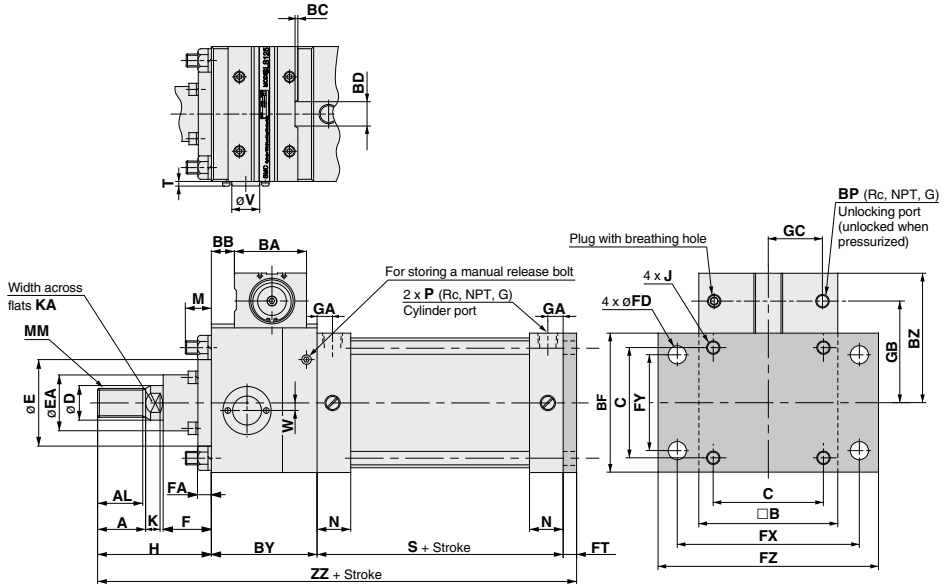

For ø180, ø200, ø250

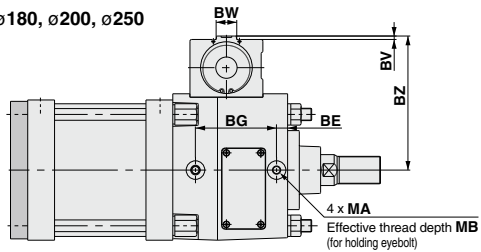

Bore size (mm)	Stroke range (mm)	(mm)																																	
		A	AL	B	BA	BB	BC	BD	BE	BG	BF	BY	BZ	BV	BW	BP	C	D	E	EA	F	FA	FD	FT	FX	FY	FZ	GA	GB	GC	H	J	K	KA	M
125	Up to 1000	50	47	145	75	18	—	—	—	—	145	110	136	—	—	1/4	115	36	90	59	43	14	19	14	190	100	230	16	107	58	110	M14 x 1.5	15	31	19
140	Up to 1000	50	47	161	78	18	3	30	—	—	160	110	146	—	—	1/4	128	36	90	59	43	14	19	20	212	112	255	16	114	64	110	M14 x 1.5	15	31	19
160	Up to 1200	56	53	182	95	23	5	46	—	—	180	132	169	—	—	1/4	144	40	90	59	43	14	19	20	236	118	275	18.5	130	74	120	M16 x 1.5	17	36	22
180	Up to 1200	63	60	204	106	36	—	—	16	118	200	167	195	5	30	3/8	162	45	115	70	48	17	24	25	265	132	320	18.5	149	86	135	M18 x 1.5	20	41	26
200	Up to 1200	63	60	226	124	40.5	—	—	21	131	225	187	216	5.5	34	3/8	182	50	115	74	48	17	24	25	280	150	335	18.5	165	97	135	M20 x 1.5	20	46	26
250	Up to 1200	71	67	277	152	58	—	—	35	155	275	237	261.5	6	42	1/2	225	60	140	86	60	20	29	30	355	180	420	23	200	117	160	M24 x 1.5	25	56	30

		(mm)									
Bore size (mm)		MM	MA	MB	N	P	S	T	V	W	ZZ
125	M30 x 1.5	—	—	35	1/2	98	5	30	—	—	332
140	M30 x 1.5	—	—	35	1/2	98	5	30	8	—	338
160	M36 x 1.5	—	—	39	3/4	106	5	30	9	—	378
180	M40 x 1.5	M12 x 1.75	25	39	3/4	111	—	—	—	—	438
200	M45 x 1.5	M16 x 2	31	39	3/4	111	—	—	—	—	458
250	M56 x 2	M20 x 2.5	41	49	1	141	—	—	—	—	568

		(mm)					
Bore size (mm)	Stroke range (mm)	e	f	h	ℓ	ZZ ₁	
125	30 to 1000	75	40	133	0.2 stroke	355	
140	30 to 1000	75	40	133	0.2 stroke	361	
160	30 to 1200	75	40	141	0.2 stroke	399	
180	30 to 1200	85	45	153	0.2 stroke	456	
200	30 to 1200	90	45	153	0.2 stroke	476	
250	30 to 1200	105	55	176	0.17 stroke	584	

		(mm)			
Bore size (mm)	Stroke range (mm)	S	Without rod boot ZZ	With rod boot ZZ ₁	
125	Up to 1000	98	332	355	
140	Up to 1000	98	338	361	
160	Up to 1200	106	378	399	
180	Up to 1200	115	442	460	
200	Up to 998	120	467	485	

- CLJ2
- CLM2
- CLG1
- CL1
- MLGC
- CNG
- MNB
- CNA2
- CNS
- CLS**
- CLQ
- RLQ
- MLU
- MLGP
- ML1C

- D-□
- X□

CLS Series

Dimensions

Single clevis type/(C)

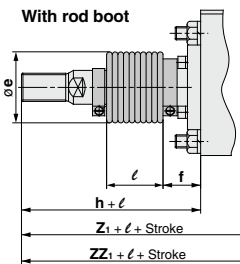
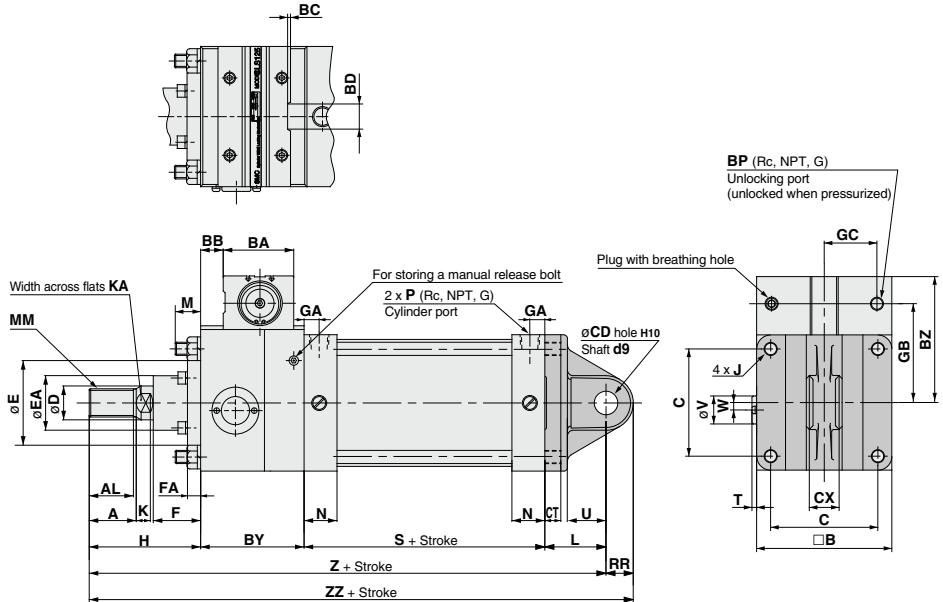

For ø180, ø200, ø250

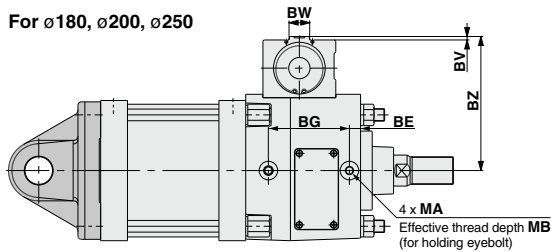

Bore size (mm)	Stroke range (mm)	A	AL	B	BA	BB	BC	BD	BE	BG	BY	BZ	BV	BW	BP	C	CD _{H10}	CT	CX	D	E	EA	F	FA	GA	GB	GCC	H	J	K	KA	L	M
125	Up to 1000	50	47	145	75	18	—	—	—	—	110	136	—	—	1/4	115	25 ^{+0.084} ₀	17	32 ^{-0.1} _{-0.3}	36	90	59	43	14	16	107	58	110	M14 x 1.5	15	31	65	19
140	Up to 1000	50	47	161	78	18	3	30	—	—	110	146	—	—	1/4	128	28 ^{+0.084} ₀	17	36 ^{-0.1} _{-0.3}	36	90	59	43	14	16	114	64	110	M14 x 1.5	15	31	75	19
160	Up to 1200	56	53	182	95	23	5	46	—	—	132	169	—	—	1/4	144	32 ^{+0.100} ₀	20	40 ^{-0.1} _{-0.3}	40	90	59	43	14	18.5	130	74	120	M16 x 1.5	17	36	80	22
180	Up to 1200	63	60	204	106	36	—	—	16	118	167	195	5	30	3/8	162	40 ^{+0.100} ₀	23	50 ^{-0.1} _{-0.3}	45	115	70	48	17	18.5	149	86	135	M18 x 1.5	20	41	90	26
200	Up to 1200	63	60	226	124	40.5	—	—	21	131	187	216	5.5	34	3/8	182	40 ^{+0.100} ₀	25	50 ^{-0.1} _{-0.3}	50	115	74	48	17	18.5	165	97	135	M20 x 1.5	20	46	90	26
250	Up to 1200	71	67	277	152	58	—	—	35	155	237	281.5	6	42	1/2	225	50 ^{+0.100} ₀	30	63 ^{-0.1} _{-0.3}	60	140	86	60	20	23	200	117	160	M24 x 1.5	25	56	110	30

Bore size (mm)	MM	MA	MB	N	P	RR	S	T	U	V	W	Z	ZZ
125	M30 x 1.5	—	—	35	1/2	29	98	5	35	30	—	383	412
140	M30 x 1.5	—	—	35	1/2	32	98	5	40	30	8	393	425
160	M36 x 1.5	—	—	39	3/4	36	106	5	45	30	9	438	474
180	M40 x 1.5	M12 x 1.75	25	39	3/4	44	111	—	50	—	—	503	547
200	M45 x 1.5	M16 x 2	31	39	3/4	44	111	—	50	—	—	523	567
250	M56 x 2	M20 x 2.5	41	49	1	55	141	—	65	—	—	648	703

Bore size (mm)	Stroke range (mm)	e	f	h	l	Z ₁	ZZ ₁
125	30 to 1000	75	40	133	0.2 stroke	406	435
140	30 to 1000	75	40	133	0.2 stroke	416	448
160	30 to 1200	75	40	141	0.2 stroke	459	495
180	30 to 1200	85	45	153	0.2 stroke	521	565
200	30 to 1200	90	45	153	0.2 stroke	541	585
250	30 to 1200	105	55	176	0.17 stroke	684	719

Bore size (mm)	Stroke range (mm)	S	Without rod boot (Z)	With rod boot (ZZ)	With rod boot (Z ₁)	With rod boot (ZZ ₁)
125	Up to 1000	98	383	412	406	435
140	Up to 1000	98	393	425	416	448
160	Up to 1200	106	438	474	459	495
180	Up to 1200	115	507	551	525	565
200	Up to 998	120	532	576	550	594

Double clevis type/(D)

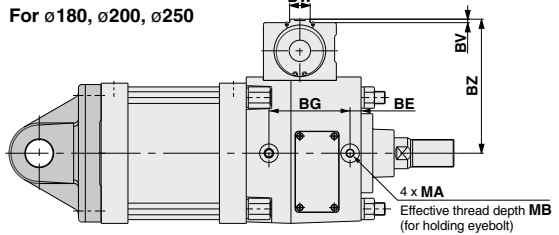
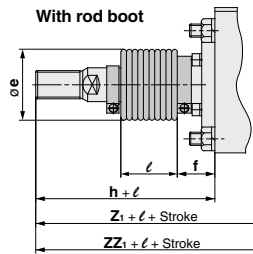
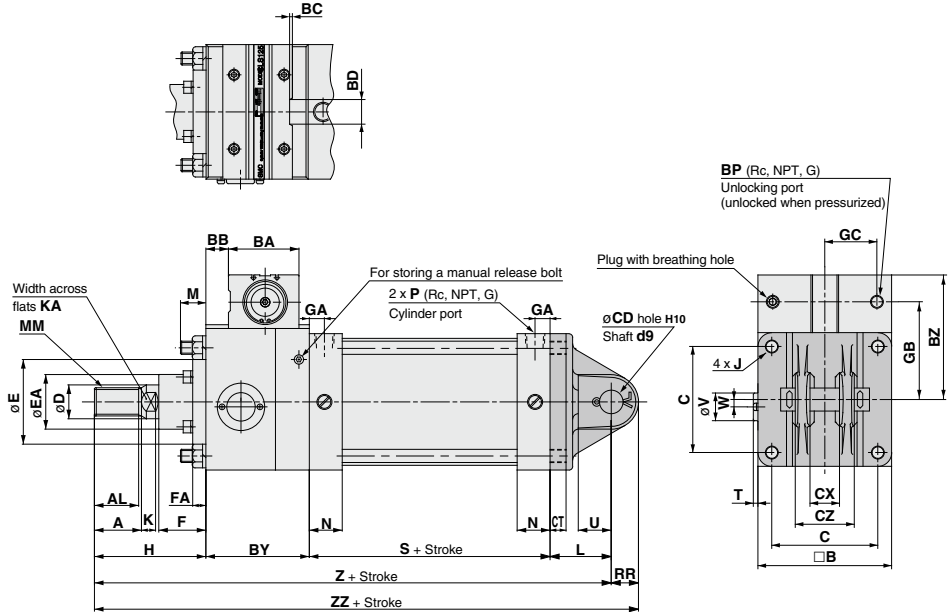

Bore size (mm)	Stroke range (mm)	A	AL	B	BA	BB	BC	BD	BE	BG	BY	BZ	BV	BW	BP	C	CD ^{H10}	CT	CX	CZ	D	E	EA	F	FA	G	AG	BGC	H	J	K	KA	L	
125	Up to 1000	50	47	145	75	18	—	—	—	110	138	—	—	1/4	115	25 ^{+0.084/0}	17	32 ^{+0.3/0}	64	0 ^{-0.2}	36	90	59	43	14	16	107	58	110	M14 x 1.5	15	31	65	
140	Up to 1000	50	47	161	78	18	3	30	—	110	146	—	—	1/4	128	28 ^{+0.084/0}	17	36 ^{+0.3/0.1}	72	0 ^{-0.2}	36	90	59	43	14	16	114	64	110	M14 x 1.5	15	31	75	
160	Up to 1200	56	53	182	95	23	5	46	—	132	169	—	—	1/4	144	32 ^{+0.100/0}	20	40 ^{+0.3/0.1}	80	0 ^{-0.2}	40	90	59	43	14	18.5	130	74	120	M16 x 1.5	17	36	80	
180	Up to 1200	63	60	204	106	36	—	—	16	118	167	195	5	30	3/8	162	40 ^{+0.100/0}	23	50 ^{+0.3/0.1}	100	-0.1/0.3	45	115	70	48	17	18.5	149	86	135	M18 x 1.5	20	41	90
200	Up to 1200	63	60	226	124	40.5	—	—	21	131	187	216	5.5	34	3/8	182	40 ^{+0.100/0}	25	50 ^{+0.3/0.1}	100	-0.1/0.3	50	115	74	48	17	18.5	165	97	135	M20 x 1.5	20	46	90
250	Up to 1200	71	67	277	152	58	—	—	35	155	237	261.5	6	42	1/2	225	50 ^{+0.100/0}	30	63 ^{+0.3/0.1}	126	-0.1/0.3	60	140	86	60	20	23	200	117	160	M24 x 1.5	25	56	110

Bore size (mm)	M	MA	MB	MM	N	P	RR	S	T	U	V	W	Z	ZZ	With Rod Boot		With Auto Switch												
															Stroke range (mm)	e	f	h	Stroke range (mm)	S	Stroke range (mm)	With rod boot Z	With rod boot Z1	With rod boot Z2					
125	19	—	—	M30 x 1.5	35	1/2	29	98	5	35	30	—	383	412	125	30 to 1000	75	40	133	0.2 stroke	406	435	125	Up to 1000	98	383	412	406	435
140	19	—	—	M30 x 1.5	35	1/2	32	98	5	40	30	8	393	425	140	30 to 1000	75	40	133	0.2 stroke	416	448	140	Up to 1000	98	393	425	416	448
160	22	—	—	M36 x 1.5	39	3/4	36	106	5	45	30	9	438	474	160	30 to 1200	75	40	141	0.2 stroke	459	495	160	Up to 1200	106	438	474	459	495
180	26	M12 x 1.75	25	M40 x 1.5	39	3/4	44	111	—	50	—	—	503	547	180	30 to 1200	85	45	153	0.2 stroke	521	565	180	Up to 1200	115	507	551	525	569
200	26	M16 x 2	31	M45 x 1.5	39	3/4	44	111	—	50	—	—	523	567	200	30 to 1200	90	45	153	0.2 stroke	541	585	200	Up to 1200	110	507	551	525	569
250	30	M20 x 2.5	41	M56 x 2	49	1	55	141	—	65	—	—	648	703	250	30 to 1200	105	55	176	0.17 stroke	664	719	250	Up to 998	120	532	576	550	594

* Clevis pins and cotter pins are included.

- CLJ2
- CLM2
- CLG1
- CL1
- MLGC
- CNG
- MNB
- CNA2
- CNS
- CLS**
- CLQ
- RLQ
- MLU
- MLGP
- ML1C

- D-□
- X□

CLS Series

Dimensions

Center trunnion type/(T)

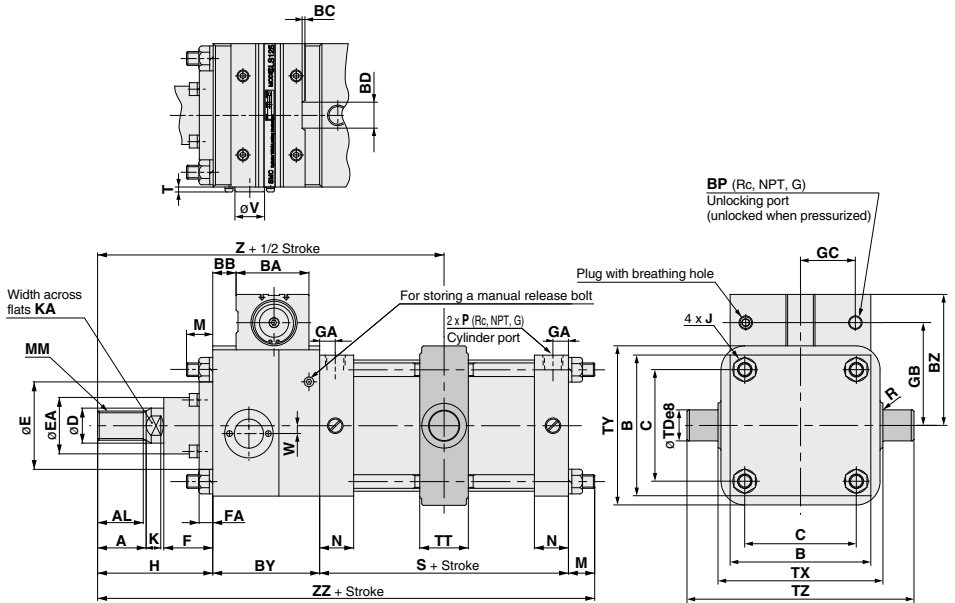

With rod boot

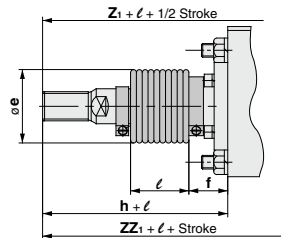

For phi180, phi200, phi250

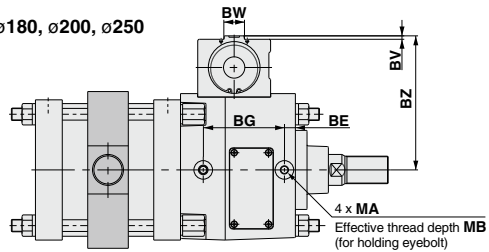

Bore size (mm)	Stroke range (mm)	(mm)																																
		A	AL	B	BAB	BB	BC	BD	BE	BG	BY	BZ	BV	BW	BP	C	D	E	EA	F	FA	GA	GB	GC	H	J	K	KA	M	MM	MA	MB	N	P
125	25 to 1000	50	47	145	75	18	—	—	—	110	136	—	—	1/4	115	36	90	59	43	14	16	107	58	110	M14 x 1.5	15	31	19	M30 x 1.5	—	—	35	1/2	
140	30 to 1000	50	47	161	78	18	3	30	—	110	146	—	—	1/4	128	36	90	59	43	14	16	114	64	110	M14 x 1.5	15	31	19	M30 x 1.5	—	—	35	1/2	
160	35 to 1200	56	53	182	95	23	5	46	—	132	169	—	—	1/4	144	40	90	59	43	14	18.5	130	74	120	M16 x 1.5	17	36	22	M36 x 1.5	—	—	39	3/4	
180	30 to 1200	63	60	204	106	36	—	—	16	118	167	195	5	30	3/8	162	45	115	70	48	17	18.5	149	86	135	M18 x 1.5	20	41	26	M40 x 1.5	M12 x 1.75	25	39	3/4
200	30 to 1200	63	60	226	124	40.5	—	—	21	131	187	218	5.5	34	3/8	182	50	115	74	48	17	18.5	165	97	135	M20 x 1.5	20	46	26	M45 x 1.5	M16 x 2	31	39	3/4
250	30 to 1200	71	67	277	152	58	—	—	35	155	237	261.5	6	42	1/2	225	60	140	86	60	20	23	200	117	160	M24 x 1.5	25	56	30	M56 x 2	M20 x 2.5	41	49	1

Bore size (mm)	R	S	T	TD _{e8}	(mm)											
					TT	TX	TY	TZ	V	W	Z	ZZ				
125	1	98	5	32 ^{+0.050} _{-0.089}	50	170	164	234	30	—	269	337				
140	1.5	98	5	36 ^{+0.050} _{-0.089}	55	190	184	262	30	8	269	337				
160	1.5	106	5	40 ^{+0.050} _{-0.089}	60	212	204	292	30	9	315	380				
180	2	111	—	45 ^{+0.050} _{-0.089}	59	236	228	326	—	—	371.5	439				
200	2	111	—	45 ^{+0.050} _{-0.089}	59	265	257	355	—	—	377.5	459				
250	3	141	—	56 ^{+0.060} _{-0.108}	69	335	325	447	—	—	467.5	568				

Bore size (mm)	Stroke range (mm)	(mm)									
		e	f	h	l	Z ₁	Z ₂				
125	30 to 1000	75	40	133	0.2 stroke	292	360				
140	30 to 1000	75	40	133	0.2 stroke	292	360				
160	30 to 1200	75	40	141	0.2 stroke	326	401				
180	30 to 1200	85	45	153	0.2 stroke	375.5	457				
200	30 to 1200	90	45	153	0.2 stroke	395.5	477				
250	30 to 1200	105	55	176	0.17 stroke	483.5	584				

Bore size (mm)	Stroke range (mm)	(mm)				
		S	Without rod boot	With rod boot	With rod boot	
125	Up to 1000	98	269	337	292	360
140	Up to 1000	98	269	337	292	360
160	Up to 1200	106	305	380	326	401
180	Up to 1200	115	358.5	443	371.5	461
200	Up to 998	120	382	468	40	486

Accessory Dimensions 1

Y Type Double Knuckle Joint

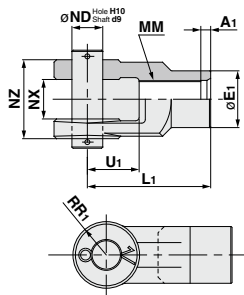

Material: Cast iron

Model	Applicable bore size (mm)	A1	E1	L1	MM	NDH10	NX	NZ	RR1	U1
Y-12	125	8	46	100	M30 x 1.5	25 ^{+0.084} ₀	32 ^{+0.3} _{-0.1}	64 ^{+0.1} _{-0.3}	27	42
Y-14	140	8	48	105	M30 x 1.5	28 ^{+0.084} ₀	36 ^{+0.3} _{-0.1}	72 ^{+0.1} _{-0.3}	30	47
Y-16	160	8	55	110	M36 x 1.5	32 ^{+0.1} ₀	40 ^{+0.3} _{-0.1}	80 ^{+0.1} _{-0.3}	34	46
Y-18	180	8	70	125	M40 x 1.5	40 ^{+0.1} ₀	50 ^{+0.3} _{-0.1}	100 ^{+0.1} _{-0.3}	42.5	54
Y-20	200	8	70	125	M45 x 1.5	40 ^{+0.1} ₀	50 ^{+0.3} _{-0.1}	100 ^{+0.1} _{-0.3}	42.5	54
Y-25	250	9	86	160	M56 x 2	50 ^{+0.1} ₀	63 ^{+0.3} _{-0.1}	126 ^{+0.1} _{-0.3}	53	81

* Knuckle pins and cotter pins are included.

I Type Single Knuckle Joint

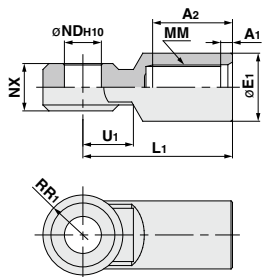

Material: Cast iron

Model	Applicable bore size (mm)	A1	A2	E1	L1	MM	NDH10	NX	RR1	U1
I-12	125	8	54	46	100	M30 x 1.5	25 ^{+0.084} ₀	32 ^{+0.1} _{-0.3}	27	33
I-14	140	8	54	48	105	M30 x 1.5	28 ^{+0.084} ₀	36 ^{+0.1} _{-0.3}	30	39
I-16	160	8	60	55	110	M36 x 1.5	32 ^{+0.1} ₀	40 ^{+0.1} _{-0.3}	34	39
I-18	180	8	67	70	125	M40 x 1.5	40 ^{+0.1} ₀	50 ^{+0.1} _{-0.3}	42.5	44
I-20	200	8	67	70	125	M45 x 1.5	40 ^{+0.1} ₀	50 ^{+0.1} _{-0.3}	42.5	44
I-25	250	9	75.5	86	160	M56 x 2	50 ^{+0.1} ₀	63 ^{+0.1} _{-0.3}	53	66

Clevis Pin/Knuckle Pin

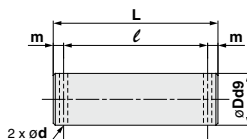

Material: Carbon steel

Model	Applicable bore size (mm)	d (drill through)	Dd9	L	ℓ	m	Cotter pin
IY-12	125	4	25 ^{-0.065} _{-0.117}	79.5	69.5	5	ø4 x 40 L
IY-14	140	4	28 ^{-0.065} _{-0.117}	86.5	76.5	5	ø4 x 40 L
IY-16	160	4	32 ^{-0.080} _{-0.142}	94.5	84.5	5	ø4 x 40 L
IY-18	180, 200	4	40 ^{-0.080} _{-0.142}	115	105	5	ø4 x 55 L
IY-25	250	5	50 ^{-0.080} _{-0.142}	144	132	6	ø5 x 65 L

* Cotter pins (2 pcs.) are included.

Rod End Nut

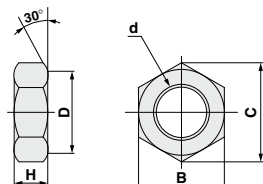

Material: Rolled steel

Model	Applicable bore size (mm)	d	H	B	C	D
NT-12	125, 140	M30 x 1.5	18	46	53.1	44
NT-16	160	M36 x 1.5	21	55	63.5	53
NT-18	180	M40 x 1.5	23	60	69.3	57
NT-20	200	M45 x 1.5	27	70	80.8	67
NT-25	250	M56 x 2	34	85	98.1	82

- CLJ2
- CLM2
- CLG1
- CL1
- MLGC
- CNG
- MNB
- CNA2
- CNS
- CLS
- CLQ
- RLQ
- MLU
- MLGP
- ML1C

- D-□
- X□

Accessory Dimensions 2

Single/Double Knuckle Joint Mounting

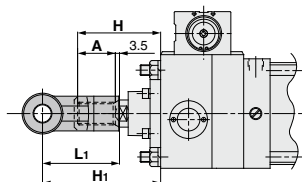

Bore size (mm)	Symbol	H	A	L ₁	H ₁	Applicable knuckle joint part nos.	
						I type single knuckle	Y type double knuckle
125		110	50	100	156.5	I-12	Y-12
140		110	50	105	161.5	I-14	Y-14
160		120	56	110	170.5	I-16	Y-16
180		135	63	125	193.5	I-18	Y-18
200		135	63	125	193.5	I-20	Y-20
250		160	71	160	245.5	I-25	Y-25

**A, H dimensions when single/
double knuckle joint and rod end
nut are mounted together.**

Bore size (mm)	A	H
125	65	125
140	65	125
160	76	140
180	83	155
200	88	160
250	106	195

* Single knuckle joint and double knuckle joint should be used separately.
(Fasten by screwing completely into the rod end threads.)

* When using a single/double knuckle joint together with a rod end nut, the A and H dimensions should be extended.

(For extension of A and H dimensions, refer to the table above and specify with "Simple Specials -XA0" (page 1254).)

Auto Switch Mounting 1

Auto Switch Proper Mounting Position (Detection at Stroke End) and Its Mounting Height

<Band mounting type>

D-A3□
D-G39/K39

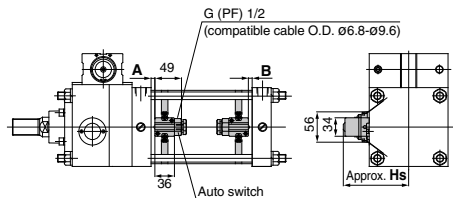

D-A44

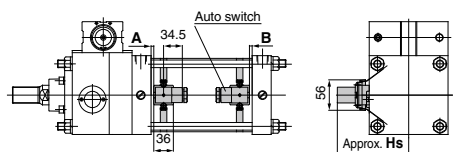

D-F5□/J59/D-F5NT
D-F5□W/J59W
D-F5BA/F59F

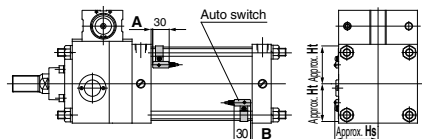

<Tie-rod mounting type>

D-Z7□/Z80/A9□/A9□V
D-Y59□/Y69□/Y7P/Y7PV/M9□/M9□V
D-Y7□W/Y7□WV/M9□W/M9□WV
D-Y7BA/M9□A/M9□AV

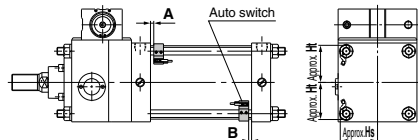

D-A5□/A6□
D-A59W

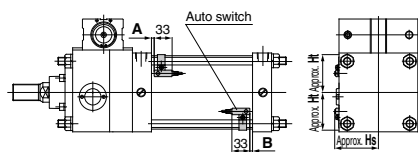

D-P3DWA

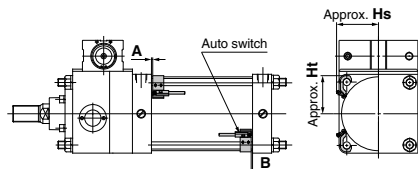

Auto Switch Proper Mounting Position

Auto switch model	D-M9□ D-M9□V D-M9□W D-M9□WV D-M9□A D-M9□AV		D-A9□ D-A9□V		D-Z7□/Z80 D-Y5□/Y6□ D-Y7P/Y7PV D-Y7□W D-Y7□WV D-Y7BA		D-A5□ D-A6□ D-A3□ D-A44 D-G39 D-K39		D-A59W		D-F5□W D-J59W D-F5BA D-F5□ D-J59 D-F59F		D-F5NT		D-P3DWA	
	A	B	A	B	A	B	A	B	A	B	A	B	A	B	A	B
	Bore size (mm)		A		A		A		A		A		A		A	
125	8	8	4	4	1.5	1.5	0	0	2	2	4.5	4.5	9.5	9.5	3.5	3.5
140	8	8	4	4	1.5	1.5	0	0	2	2	4.5	4.5	9.5	9.5	3.5	3.5
160	8	8	4	4	1.5	1.5	0	0	2	2	4.5	4.5	9.5	9.5	3.5	3.5
180	13.5	12.5	9.5	7.5	7	5	3.5	1.5	7.5	5.5	10	8	15	13	9	7
200	16	14	12	10	9.5	7.5	6	4	10	8	12.5	10.5	17.5	15.5	11.5	9.5

* Figures in the table above are used as a reference when mounting the auto switches for stroke end detection. In the case of actually setting the auto switches, adjust them after confirming their operation.

Auto Switch Mounting Height

Auto switch model	D-M9□ D-M9□W D-M9□A D-A9□ D-A9□V		D-M9□V D-M9□WV D-M9□AV		D-Z7□/Z80 D-Y5□/Y6□ D-Y7P D-Y7PV D-Y7□W D-Y7□WV D-Y7BA		D-A3□ D-G39 D-K39		D-A44		D-A5□ D-A6□ D-A59W		D-F5□ D-J59 D-F5□W D-J59W D-F5BA D-F59F D-F5NT		D-P3DWA	
	Hs	Ht	Hs	Ht	Hs	Ht	Hs	Hs	Hs	Ht	Hs	Ht	Hs	Ht	Hs	Ht
	Bore size (mm)		Hs		Hs		Hs		Hs		Hs		Hs		Hs	
125	69	69.5	71.5	69.5	69	69.5	116	126	75.5	69.5	74.5	70	76	69.5		
140	76	76	77.5	76	76	76	124	134	81	76.5	80	76.5	82	76		
160	85	85	86	85	85	85	134.5	144.5	89	87.5	88	87.5	91	85		
180	95	95	95.5	95	95	95	144	154	97	97.5	96	97.5	100	95		
200	106	106	106	106	106	106	154	164	107	108	107.5	108	111	106		

- CLJ2
- CLM2
- CLG1
- CL1
- MLGC
- CNG
- MNB
- CNA2
- CNS
- CLS
- CLQ
- RLQ
- MLU
- MLGP
- ML1C

- D-□
- X□

Auto Switch Mounting 2

Minimum Stroke for Auto Switch Mounting

n: No. of auto switches (mm)

Auto switch model	No. of auto switches mounted	Mounting brackets other than center trunnion	Center trunnion type				
			ø125	ø140	ø160	ø180	ø200
D-M9□ D-M9□W	2 pcs. (Different surfaces, Same surface), 1 pc.	15	105	110		115	
	"n" pcs.	$15 + 40 \frac{(n-2)}{2}$ (n = 2, 4, 6, 8...) ^{Note 1}	$105 + 40 \frac{(n-4)}{2}$ (n = 4, 8, 12, 16...) ^{Note 2}	$110 + 40 \frac{(n-4)}{2}$ (n = 4, 8, 12, 16...) ^{Note 2}		$115 + 40 \frac{(n-4)}{2}$ (n = 4, 8, 12, 16...) ^{Note 2}	
D-M9□V D-M9□WV	2 pcs. (Different surfaces, Same surface), 1 pc.	10	80	85		90	
	"n" pcs.	$10 + 30 \frac{(n-2)}{2}$ (n = 2, 4, 6, 8...) ^{Note 1}	$80 + 30 \frac{(n-4)}{2}$ (n = 4, 8, 12, 16...) ^{Note 2}	$85 + 30 \frac{(n-4)}{2}$ (n = 4, 8, 12, 16...) ^{Note 2}		$90 + 30 \frac{(n-4)}{2}$ (n = 4, 8, 12, 16...) ^{Note 2}	
D-M9□A	2 pcs. (Different surfaces, Same surface), 1 pc.	20	115			120	
	"n" pcs.	$20 + 40 \frac{(n-2)}{2}$ (n = 2, 4, 6, 8...) ^{Note 1}	$115 + 40 \frac{(n-2)}{2}$ (n = 4, 8, 12, 16...) ^{Note 2}			$120 + 40 \frac{(n-2)}{2}$ (n = 4, 8, 12, 16...) ^{Note 2}	
D-M9□AV	2 pcs. (Different surfaces, Same surface), 1 pc.	15	90			95	
	"n" pcs.	$15 + 30 \frac{(n-2)}{2}$ (n = 2, 4, 6, 8...) ^{Note 1}	$90 + 30 \frac{(n-2)}{2}$ (n = 4, 8, 12, 16...) ^{Note 2}			$95 + 30 \frac{(n-2)}{2}$ (n = 4, 8, 12, 16...) ^{Note 2}	
D-A9□	2 pcs. (Different surfaces, Same surface), 1 pc.	15	100	105		110	
	"n" pcs.	$15 + 40 \frac{(n-2)}{2}$ (n = 2, 4, 6, 8...) ^{Note 1}	$100 + 40 \frac{(n-4)}{2}$ (n = 4, 8, 12, 16...) ^{Note 2}	$105 + 40 \frac{(n-4)}{2}$ (n = 4, 8, 12, 16...) ^{Note 2}		$110 + 40 \frac{(n-4)}{2}$ (n = 4, 8, 12, 16...) ^{Note 2}	
D-A9□V	2 pcs. (Different surfaces, Same surface), 1 pc.	10	75	80		85	
	"n" pcs.	$10 + 30 \frac{(n-2)}{2}$ (n = 2, 4, 6, 8...) ^{Note 1}	$75 + 30 \frac{(n-4)}{2}$ (n = 4, 8, 12, 16...) ^{Note 2}	$80 + 30 \frac{(n-4)}{2}$ (n = 4, 8, 12, 16...) ^{Note 2}		$85 + 30 \frac{(n-4)}{2}$ (n = 4, 8, 12, 16...) ^{Note 2}	
D-A5□/A6□ D-A59W D-F5□/J59 D-F5□W D-J59W D-F5BA D-F59F	2 pcs. (Different surfaces, Same surface), 1 pc.	25	125		135		150
	"n" pcs. (Same surface)	$25 + 55 \frac{(n-2)}{2}$ (n = 2, 4, 6, 8...) ^{Note 1}	$125 + 55 \frac{(n-4)}{2}$ (n = 4, 8, 12, 16...) ^{Note 2}		$135 + 55 \frac{(n-4)}{2}$ (n = 4, 8, 12, 16...) ^{Note 2}		$150 + 55 \frac{(n-4)}{2}$ (n = 4, 8, 12, 16...) ^{Note 2}
D-F5NT	2 pcs. (Different surfaces, Same surface), 1 pc.	35	145		155		170
	"n" pcs. (Same surface)	$35 + 55 \frac{(n-2)}{2}$ (n = 2, 4, 6, 8...) ^{Note 1}	$145 + 55 \frac{(n-4)}{2}$ (n = 4, 8, 12, 16...) ^{Note 2}		$155 + 55 \frac{(n-4)}{2}$ (n = 4, 8, 12, 16...) ^{Note 2}		$170 + 55 \frac{(n-4)}{2}$ (n = 4, 8, 12, 16...) ^{Note 2}
D-A3□ D-G39 D-K39	2 pcs. $\frac{ø}{2}$ $\frac{ø}{4}$ $\frac{ø}{4}$	Different surfaces	35		110		150
		Same surface	100				
	"n" pcs.	Different surfaces	$35 + 30(n-2)$ (n = 2, 3, 4, 5...)		$110 + 30(n-2)$ (n = 2, 4, 6, 8...) ^{Note 1}		$150 + 30(n-2)$ (n = 2, 4, 6, 8...) ^{Note 1}
		Same surface	$100 + 100(n-2)$ (n = 2, 3, 4, 5...)		$110 + 100(n-2)$ (n = 2, 4, 6, 8...) ^{Note 1}		$150 + 100(n-2)$ (n = 2, 4, 6, 8...) ^{Note 1}
1 pc.	15		110		150		
D-A44	2 pcs. $\frac{ø}{2}$ $\frac{ø}{4}$ $\frac{ø}{4}$	Different surfaces	35		110		150
		Same surface	55				
	"n" pcs.	Different surfaces	$35 + 30(n-2)$ (n = 2, 3, 4, 5...)		$110 + 30(n-2)$ (n = 2, 4, 6, 8...) ^{Note 1}		$150 + 30(n-2)$ (n = 2, 4, 6, 8...) ^{Note 1}
		Same surface	$55 + 55(n-2)$ (n = 2, 3, 4, 5...)		$110 + 50(n-2)$ (n = 2, 4, 6, 8...) ^{Note 1}		$150 + 50(n-2)$ (n = 2, 4, 6, 8...) ^{Note 1}
1 pc.	15		110		150		
D-Z7□ D-Z80 D-Y59□ D-Y7P D-Y7□W	2 pcs. (Different surfaces, Same surface), 1 pc.	15	105	110		115	
	"n" pcs.	$15 + 40 \frac{(n-2)}{2}$ (n = 2, 4, 6, 8...) ^{Note 1}	$105 + 40 \frac{(n-4)}{2}$ (n = 4, 8, 12, 16...) ^{Note 2}	$110 + 40 \frac{(n-4)}{2}$ (n = 4, 8, 12, 16...) ^{Note 2}		$115 + 40 \frac{(n-4)}{2}$ (n = 4, 8, 12, 16...) ^{Note 2}	
D-Y69□ D-Y7PV D-Y7□WV	2 pcs. (Different surfaces, Same surface), 1 pc.	10	90	95		100	
	"n" pcs.	$10 + 30 \frac{(n-2)}{2}$ (n = 2, 4, 6, 8...) ^{Note 1}	$90 + 30 \frac{(n-4)}{2}$ (n = 4, 8, 12, 16...) ^{Note 2}	$95 + 30 \frac{(n-4)}{2}$ (n = 4, 8, 12, 16...) ^{Note 2}		$100 + 30 \frac{(n-4)}{2}$ (n = 4, 8, 12, 16...) ^{Note 2}	
D-Y7BA	2 pcs. (Different surfaces, Same surface), 1 pc.	20	115	120	125		130
	"n" pcs.	$20 + 45 \frac{(n-2)}{2}$ (n = 2, 4, 6, 8...) ^{Note 1}	$115 + 45 \frac{(n-4)}{2}$ (n = 4, 8, 12, 16...) ^{Note 2}	$120 + 45 \frac{(n-4)}{2}$ (n = 4, 8, 12, 16...) ^{Note 2}	$125 + 45 \frac{(n-4)}{2}$ (n = 4, 8, 12, 16...) ^{Note 2}		$130 + 45 \frac{(n-4)}{2}$ (n = 4, 8, 12, 16...) ^{Note 2}
D-P3DWA	2 pcs. (Different surfaces, Same surface), 1 pc.	20	110	115		120	
	"n" pcs.	$20 + 50 \frac{(n-2)}{2}$ (n = 2, 4, 6, 8...) ^{Note 1}	$110 + 50 \frac{(n-4)}{2}$ (n = 4, 8, 12, 16...) ^{Note 2}	$115 + 50 \frac{(n-4)}{2}$ (n = 4, 8, 12, 16...) ^{Note 2}		$120 + 50 \frac{(n-4)}{2}$ (n = 4, 8, 12, 16...) ^{Note 2}	

Note 1) When "n" is an odd number, an even number that is one larger than this odd number is used for the calculation. Note 2) When "n" is an odd number, a multiple of 4 that is larger than this odd number is used for the calculation.

Proper Mounting Positions for Lock Unit Auto Switches

The operating status (at the unlocked end) of the lock unit (brake piston) can be detected by a signal from the auto switch, which is mounted on the brake cylinder of the CLS series.

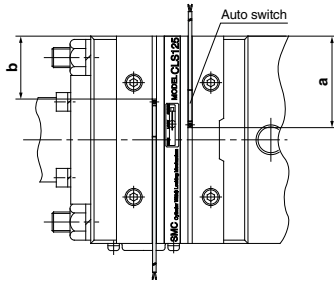

Auto switch model	(mm)			
	D-A90 D-A93		D-M9N D-M9P D-M9B	
Bore size	a	b	a	b
125	62	42	58	46
140	70.5	50.5	66.5	54.5
160	70.5	50.5	66.5	54.5
180	80.5	60.5	76.5	64.5
200	86	66	82	70
250	102	82	98	86

* Be sure to confirm operation after mounting.

Operating Range

Auto switch model	(mm)				
	125	140	160	180	200
D-M9□/M9□V D-M9□W/M9□WV D-M9□A/M9□AV	7	6.5	6.5	7	7
D-A9□/A9□V	12	12.5	11.5	12	12.5
D-Z7□/Z80	14	14.5	13	14	14.5
D-A3□/A44 D-A5□/A6□	10	10	10	10	10
D-A59W	17	17	17	17	17
D-Y59□/Y69□ D-Y7P/Y7PV D-Y7□W/Y7□WV D-Y7BA	12	13	7	7.5	8
D-F5□/J59/F59F D-F5□W/J59W D-F5BA/F5NT	5	5	5.5	6	6
D-G39/K39	11	11	10	10	10
D-P3DWA	6	6.5	6.5	6.5	7

* Since this is a guideline including hysteresis, not meant to be guaranteed (assuming approximately ±30% dispersion).
There may be the case to change substantially depending on an ambient environment.

Auto Switch Mounting Bracket Part No.

Auto switch model	Bore size (mm)				
	ø125	ø140	ø160	ø180	ø200
D-M9□/M9□V D-M9□W/M9□WV D-M9□A/M9□AV D-A9□/A9□V	BS5-125	BS5-125	BS5-160	BS5-180	BS5-200
D-A5□/A6□ D-A59W D-F5□/J59 D-F5□W/J59W D-F5BA D-F59F/F5NT	BT-12	BT-12	BT-16	BT-18A	BT-20
D-A3□/A44 D-G39/K39	BS1-125	BS1-140	BS1-160	BS1-180	BS1-200
D-Z7□/Z80 D-Y5□/Y6□ D-Y7P/Y7PV D-Y7□W/Y7□WV D-Y7BA	BS4-125	BS4-125	BS4-160	BS4-180	BS4-200
D-P3DWA	BS7-125S	BS7-125S	BS7-160S	BS7-180S	BS7-200S

[Mounting screw set made of stainless steel]

The following set of mounting screws made of stainless steel (including nuts) is available. Use it in accordance with the operating environment. (Please order the auto switch mounting bracket separately, since it is not included.)

BBA1: For D-A5/A6/F5/J5 types

D-F5BA auto switch is set on the cylinder with the stainless steel screws above when shipped. When an auto switch is shipped independently, BBA1 is attached.

Note 1) Refer to page 1233 for the details of BBA1.

Note 2) When using D-M9□A(V)/Y7BA, do not use the steel set screws which is included with the auto switch mounting brackets above (BS5-□□□, BS4-□□□). Order a stainless steel screw set (BBA1) separately, and select and use the M4 x 8L stainless steel set screws included in the BBA1.

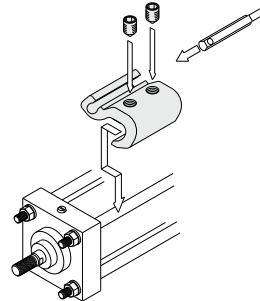

* The above figure shows the mounting example of D-A9□(V)/M9□(V)/M9□W(V)/M9□A(V).

- CLJ2
- CLM2
- CLG1
- CL1
- MLGC
- CNG
- MNB
- CNA2
- CNS
- CLS
- CLQ
- RLQ
- MLU
- MLGP
- ML1C

- D-□
- X□

Auto Switch Mounting 3

Besides the models listed in How to Order, the following auto switches are applicable.
Refer to page 1119 to 1245 for the detailed specifications.

Auto switch type	Model	Electrical entry (Fetching direction)	Features
Reed	D-A90V	Grommet (Perpendicular)	Without indicator light
	D-A93V, A96V		—
	D-Z73, Z76		
	D-A53, A56	Grommet (In-line)	
	D-A64, A67		Without indicator light
	D-Z80		
Solid state	D-M9NV, M9PV, M9BV	Grommet (Perpendicular)	—
	D-Y69A, Y69B, Y7PV		2-color indication
	D-M9NWV, M9PWV, M9BWW		
	D-Y7NWW, Y7PWW, Y7BWW		
	D-M9NAV, M9PAV, M9BAV		Water resistant (2-color indicator)
	D-F59, F5P, J59	Grommet (In-line)	—
	D-Y59A, Y59B, Y7P		2-color indication
	D-F59W, F5PW, J59W		
	D-Y7NW, Y7PW, Y7BW		
	D-F5BA, Y7BA		Water resistant (2-color indicator)
	D-F5NT		With timer

* For solid state auto switches, auto switches with a pre-wired connector are also available. Refer to pages 1192 and 1193.

* Normally closed (NC = b contact) solid state auto switches (D-F9G/F9H/Y7G/Y7H types) are also available. Refer to pages 1137 and 1139 for details.



CLS Series Specific Product Precautions 1

Be sure to read this before handling the products.
Refer to back page 50 for Safety Instructions and pages 3 to 12 for Actuator and Auto Switch Precautions.

Parts Description

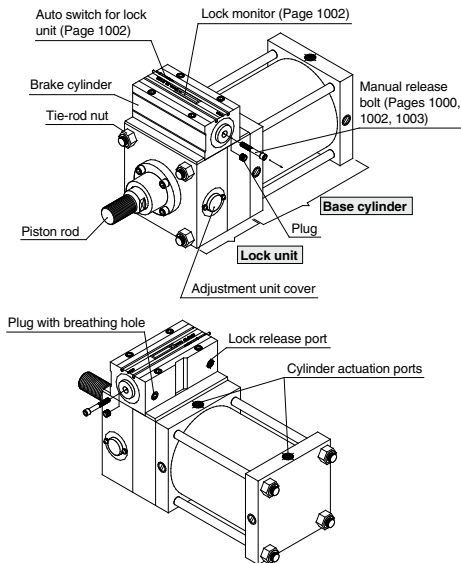

Design of Equipment and Machinery

Warning

1. Construct so that the human body will not come into direct contact with driven objects or the moving parts of the cylinder with brake.

Devise a safe structure by attaching protective covers that prevent direct contact with the human body, or in cases where there is a danger of contact, provide sensors or other devices to perform an emergency stop, etc., before contact occurs.

2. Use a balance circuit, taking cylinder lurching into consideration.

In cases such as an intermediate stop, where a lock is operated at a desired position within the stroke and air pressure is applied from only one side of the cylinder, the piston will lurch at high speed when the lock is released. In such situations, there is a danger of causing human injury by having hands or feet, etc., caught, and also a danger of causing damage to the equipment. In order to prevent this lurching, a balance circuit such as the recommended air pressure circuits (page 1001) should be used.

3. When designing equipment and machinery, give consideration to clearance and mounting orientation so that manual release of the lock (using the manual release bolt) will be possible.

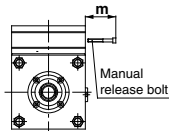

* Minimum Clearance for Manual Release (mm)

Bore size (mm)	Clearance: m
125	50
140	60
160	60
180	70
200	80
250	90

Selection

Warning

1. When in a locked condition, do not apply a load accompanied by an impact shock, strong vibration or turning force, etc.

Use caution, because an external action such as an impacting load, strong vibration or turning force, may damage the locking mechanism or reduce its life.

2. Consider stopping accuracy and the amount of overrun when an intermediate stop is performed.

Due to the nature of a mechanical lock, there is a momentary lag with respect to the stop signal, and a time delay occurs before stopping. The cylinder stroke resulting from this delay is the overrun amount. The difference between the maximum and minimum overrun amounts is the stopping accuracy.

- Place a limit switch before the desired stopping position, at a distance equal to the overrun amount.
- The limit switch must have a detection length (dog length) of the overrun amount + α .
- SMC's auto switches have operating ranges from 8 to 14 mm (depending on the switch model).

When the overrun amount exceeds this range, self-holding of the contact should be performed at the switch load side.

* Refer to page 983 regarding stopping accuracy.

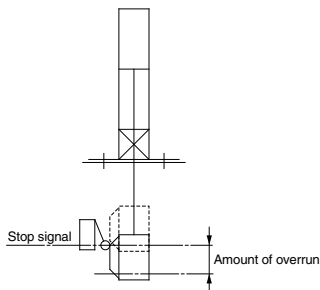

3. In order to further improve stopping accuracy, the time from the stop signal to the operation of the lock should be shortened as much as possible.

To accomplish this, use a device such as a highly responsive electric control circuit or solenoid valve driven by direct current, and place the solenoid valve as close as possible to the cylinder.

4. Note that stopping accuracy will be influenced by changes in piston speed.

When piston speed changes during the course of the cylinder stroke due to variations in the load or disturbances, etc., the dispersion of stopping positions will increase. Therefore, consideration should be given to establishing a standard speed for the piston just before it reaches the stopping position. Moreover, the dispersion of stopping positions will increase during the cushioned portion of the stroke and during the accelerating portion of the stroke after the start of operation, due to the large changes in piston speed.

CLJ2

CLM2

CLG1

CL1

MLGC

CNG

MNB

CNA2

CNS

CLS

CLQ

RLQ

MLU

MLGP

ML1C

D-

-X



CLS Series

Specific Product Precautions 2

Be sure to read this before handling the products.

Refer to back page 50 for Safety Instructions and pages 3 to 12 for Actuator and Auto Switch Precautions.

Selection

⚠ Warning

- Holding force (maximum static load) means the maximum capability of holding a static load that is not accompanied by vibration or impact under the condition that no load is applied. Therefore, it does not refer to a load that cannot be held constantly.**

Determine the optimum bore size which meets your application based on the model selection procedure. The procedures for Model Selection, assuming the intermediate stop application (including the emergency stop in operation), are shown on pages 980 and 981. Only when locking the cylinder in a condition where a kinetic energy is not applied, such as in a drop prevention application, the maximum load mass when using the lock should not exceed the upper limit of the load mass, according to the operating pressure, when the maximum speed is $V = 100$ mm/s in Graph 5 through 7 on page 981.

Mounting

⚠ Warning

- Be certain to connect the piston rod end to the load with the lock released.**

If connected when in the locked condition, turning force or a load greater than the holding force may operate on the piston rod and cause damage to the lock mechanism. The CLS series is equipped with an emergency unlocking mechanism, however, the load should be connected to the piston rod end with the lock in the released condition. This can be accomplished manually or by simply connecting an air line to the unlocking port and supplying air pressure of 0.25 MPa or more.

- The unit is shipped from the factory with the lock in the released condition. Since the lock will not operate in this condition, be sure to put it in the locked condition before operation, following the procedure given below.**

- Remove the manual release bolt (B) using a hexagon wrench. (The manual release bolt can be removed easier by applying air pressure to the lock release port.)
- Confirm that the white mark on the lock monitor (A) is in the LOCK position.
- Plug the bolt insertion hole with the included hexagon socket head taper plug.

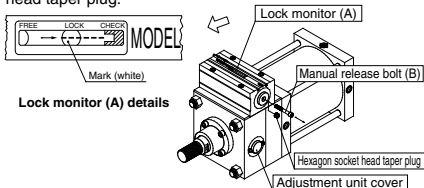

Manual Release Bolt		Unit: mm	Hexagon Socket Head Taper Plug Size	
Bore size (mm)	Size		Bore size (mm)	Hexagon socket head taper plug
125	M6 x 1.0 x 35 L		125	
140	M6 x 1.0 x 40 L		140	Rc 1/4
160	M8 x 1.25 x 40 L		160	Rc 3/8
180	M10 x 1.5 x 50 L		180	Rc 1/2
200	M10 x 1.5 x 55 L		200	Rc 1/2
250	M12 x 1.75 x 70 L		250	Rc 3/4

* Use a hexagon socket head cap screw if the included manual release bolt is not available.

Mounting

⚠ Warning

- Remove the manual release bolt and attach it to the cylinder cover storage part. (The bolt is necessary at times of maintenance.)
- Mount the cylinder after confirming that the lock is working correctly by applying or releasing air pressure to or from the lock release port. Apply air pressure (more than 0.25 MPa) to unlock the cylinder or release the air pressure (0 MPa) to lock the cylinder.
- The adjustment screw inside the adjustment unit cover is set before shipment. Since any discrepancy in this adjustment can cause cylinder or lock malfunction, etc., never touch the screw.
- When raising the unit, do not insert your hands or fingers.

As this is a heavyweight product, be sure to use caution. Screw holes for installing eyebolts are provided for $\phi 180$, $\phi 200$ and $\phi 250$. (Eyebolts are not included in the unit.)

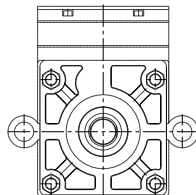

⚠ Caution

- Do not apply an offset load to the piston rod.** Particular care should be taken to match the load's center of gravity with the center of the cylinder shaft. When there is a large discrepancy, the piston rod may be subjected to uneven wear or damage due to the inertial moment during locking stops.

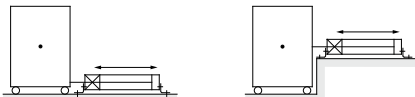

X Load center of gravity and cylinder shaft center are not matched. ○ Load center of gravity and cylinder shaft center are matched.

* An offset load can be operated if there is an effective guide to absorb all of the generated moment.



CLS Series

Specific Product Precautions 3

Be sure to read this before handling the products.

Refer to back page 50 for Safety Instructions and pages 3 to 12 for Actuator and Auto Switch Precautions.

Mounting

⚠ Caution

2. Cautions when using the base unit and when changing bracket positions, etc.

The lock unit and cylinder rod cover are assembled as shown in the drawing below. For this reason, it cannot be installed as in the case of common air cylinders, by using the basic type and screwing the cylinder tie-rods directly to machinery. Furthermore, when brackets are replaced, the unit holding tie-rod may become loose and they should be retightened.

Bore size (mm)	Tie-rod nut	Bore size (mm)	Tie-rod nut
125	JIS B1181 Class 2 M14 x 1.5	200	JIS B1181 Class 2 M20 x 1.5
140	JIS B1181 Class 2 M14 x 1.5	250	JIS B1181 Class 2 M24 x 1.5
160	JIS B1181 Class 2 M16 x 1.5		
180	JIS B1181 Class 2 M18 x 1.5		

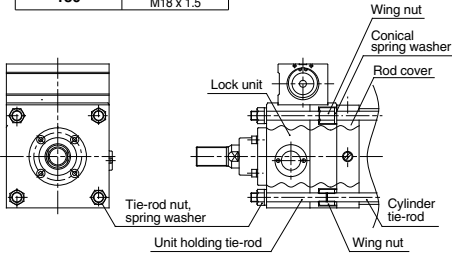

3. When installing the cylinder to machinery, etc., secure enough clearance and consider the mounting direction for manual lock release (releasing with the manual release bolt).

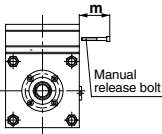

* Minimum Clearance for Manual Release (mm)

Bore size (mm)	Clearance: m
125	50
140	60
160	70
180	80
200	80
250	90

Adjustment

⚠ Caution

1. Adjust the cylinder's air balance. Balance the load by adjusting the air pressure in the front and rear sides of the cylinder with the load connected to the cylinder and the lock in a released condition. Lurching of the cylinder when unlocked can be prevented by carefully adjusting this air balance.

2. Adjust the mounting positions of the detectors on auto switches, etc. When intermediate stops are to be performed, adjust the mounting positions of detectors on auto switches, etc., taking into consideration the overrun amount with respect to the desired stopping positions.

3. Do not open the cushion valve excessively.

If the cushion valve is rotated excessively in the opening direction (counterclockwise), it could be damaged. Be aware that the valve could slip out, or the threads becomes too short.

Pneumatic Circuits

⚠ Warning

1. Be certain to use a pneumatic circuit which will apply balancing pressure to both sides of the piston when in a locked stop.

In order to prevent cylinder lurching when restarting or manually unlocking after a locked stop, a circuit should be used to apply balancing pressure to both sides of the piston, thereby canceling the force generated by the load in the direction of piston movement.

2. The effective area of the lock release solenoid valve should be at least 25% of the effective area of the cylinder driving solenoid valve, and it should be installed as close to the cylinder as possible so that it is closer than the cylinder driving solenoid valve.

If the effective area of the lock release solenoid valve is small or if it is installed at a distance from the cylinder, the time required for exhausting air for releasing the lock will be longer, which may cause a delay in the locking operation.

The delay in the locking operation may result in problems such as increase of overruning when performing intermediate stop or emergency stop during operation, or if maintaining position from the operation stop state such as drop prevention, workpieces may be dropped depending on the timing of the load action to the operation delay of the lock.

3. Avoid backflow of the exhaust pressure when there is a possibility of interference of exhaust air, for example for a common exhaust type valve manifold.

The lock may not operate properly when the exhaust air pressure backflows due to interference of the exhaust air when exhausting air for lock release. It is recommended to use an individual exhaust type manifold or individual valves.

4. Allow at least 0.5 seconds from a locked stop (intermediate stop of the cylinder) until release of the lock.

When the locked stop time is too short, the piston rod (and load) may lurch at a speed greater than the control speed of the speed controller.

5. When restarting, control the switching signal for the unlocking solenoid valve so that it acts before or at the same time as the cylinder drive solenoid valve.

If the signal is delayed, the piston rod (and load) may lurch at a speed greater than the control speed of the speed controller.

6. Carefully check for dew condensation due to repeated air supply and exhaust of the locking solenoid valve.

The operating stroke of the lock part is very small. So, if the piping is long and the air supply and exhaust are repeated, the dew condensation caused by the adiabatic expansion accumulates in the lock part. This may corrode internal parts, causing air leak or lock release fault.

7. Basic circuits

1. [Horizontal]

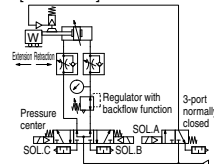

SOL.A	SOL.B	SOL.C	Action
ON	ON	OFF	Extension
OFF	OFF	OFF	Locked stop
ON	OFF	OFF	Unlocked
ON	ON	OFF	Extension
ON	OFF	ON	Retraction
OFF	OFF	OFF	Locked stop
ON	OFF	ON	Unlocked
ON	OFF	ON	Retraction

0.5 s or more
0 to 0.5 s

2. [Vertical]

[Load in the direction of rod extension]

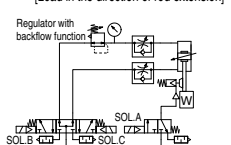

[Load in the direction of rod retraction]

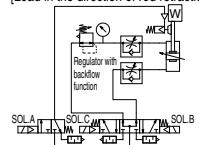

* The symbol for the cylinder with lock in the basic circuit uses SMC original symbol.

CLJ2

CLM2

CLG1

CL1

MLGC

CNG

MNB

CNA2

CNS

CLS

CLQ

RLQ

MLU

MLGP

ML1C

D-□

-X□



CLS Series

Specific Product Precautions 4

Be sure to read this before handling the products.

Refer to back page 50 for Safety Instructions and pages 3 to 12 for Actuator and Auto Switch Precautions.

Lock Monitor

⚠ Caution

The CLS series is equipped with a lock monitor on the lock unit. Use the lock monitor as a criterion to confirm the operating condition of the lock unit (brake piston) and the state of wear (life) of the brake shoe.

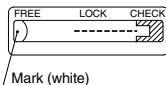

Unlocked

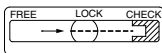

Locked by operation of brake

* Please note that the position of the mark when locked varies somewhat from unit to unit.

Brake shoe life

The position of the lock condition mark on the lock monitor gradually moves to the right side with wear of the shoe, etc. When the mark is half way or more into the CHECK zone, this indicates that the brake shoe is near the end of its life. (The brake will not immediately become ineffective in this condition.)

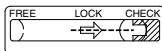

Auto Switch for Lock Unit

⚠ Caution

1. By installing a switch on the brake cylinder of the CLS series, the operating condition (unlocked side) of the lock unit (brake piston) can be detected as a switch signal.

* The condition of the lock monitor and the detection signal from the lock unit auto switch do not directly confirm the locking condition at the piston rod, but confirm this indirectly from the position of the brake piston.

Lock unit mechanism

The spring force applied to the brake piston is transmitted and magnified through the lever, eccentric cam shaft and brake shoe holder, finally tightening on the piston rod via the brake shoe and locking the piston rod by means of their mutual frictional force.

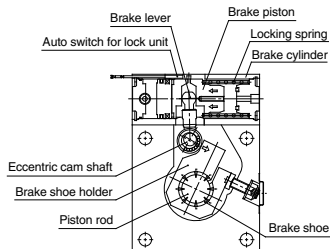

Locked condition (when air is exhausted.)

Manual Unlocking

⚠ Warning

1. Never perform the manual unlocking operation (with the manual release bolt, etc.) until safety has been confirmed.

- 1) If air pressure is applied to only one side of the cylinder when unlocking is performed, the moving parts of the cylinder may lurch at high speed causing a serious hazard.
- 2) When unlocking is performed, be sure to confirm that personnel are not within the movement range of the load, and also that no problems will be caused if the load is actuated.

2. When unlocking in the case of loads which move up and down, take measures to assure that the load will not drop.

- 1) Perform work with the load at its lowest position.
- 2) Prevent dropping of the load by using a support or brace, etc.
- 3) Verify that balanced pressure is applied to both sides of the piston.

⚠ Caution

1. The CLS series manual release mechanism is an emergency unlocking mechanism only.

During an emergency when the air supply is cut off, it is used to alleviate a problem by forcibly pulling the brake piston back to release the lock.

2. In the case of large bore cylinders, even when the lock is released, operational resistance as shown in the table below is generated in a non-load state.

Bore size (mm)	125	140	160	180	200	250
Operational resistance (N)	962	1206	1576	1995	2463	3848

3. Care must be taken, because if the manual release bolt is screwed in only part way and air is supplied to the unlocking port, or it is changed from a supply to an exhaust state, the head of the manual release bolt may be ejected from the end of the brake cylinder or be pulled in creating a serious hazard.

Unlocking procedure using the manual release bolt

1. Remove the hexagon socket head taper plug which is on the same side as the brake cylinder adjustment unit cover.
2. Insert the manual release bolt (see table below) into the threads and screw it in clock-wise.
3. The lock is released by screwing in the manual release bolt until the white mark of the lock monitor on the top of the brake cylinder moves to the FREE position.

Unit: mm						
Bore size (mm)	125	140	160	180	200	250
Manual release bolt	M6 x 1.0 x 35 L	M6 x 1.0 x 40 L	M8 x 1.25 x 40 L	M10 x 1.5 x 50 L	M10 x 1.5 x 55 L	M12 x 1.75 x 70 L
Screw depth	30	32	35	40.5	45	55

* In case the manual release bolt is not available, use an appropriate hexagon socket head bolt (full thread) as shown above.



CLS Series

Specific Product Precautions 5

Be sure to read this before handling the products.

Refer to back page 50 for Safety Instructions and pages 3 to 12 for Actuator and Auto Switch Precautions.

Manual Unlocking

⚠ Caution

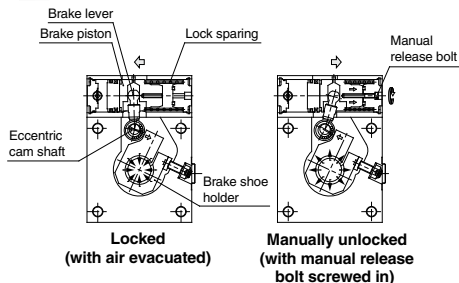

[Principle]

When the manual release bolt is screwed clockwise, the brake piston is pulled back and the spring is compressed. This causes the lever to be returned, releasing the lock.

Operating Environment

⚠ Caution

1. In locations where the cylinder body will be directly exposed to cutting oil or coolant, etc., a cover or other protection should be provided for the cylinder body and rod.

Maintenance

⚠ Caution

1. The operating condition of the lock unit (brake piston) can be confirmed externally by means of the lock monitor.

- 1) When the lock monitor mark has moved half way or more into the CHECK zone
If used in this condition, the holding force will gradually decrease. If an operational problem is found in the course of checking the lock's operating condition, early replacement of the cylinder body or lock unit is necessary. Contact SMC regarding replacement of the lock unit.
- 2) When the lock monitor mark moves into the CHECK zone prematurely
Since there is a possibility of damage to the lock unit, consult with SMC after reviewing the method of operation.

2. This cylinder is a non-lube type. Do not lubricate the cylinder or apply grease to the piston rod, as there is a danger of drastically reducing brake performance.

3. When replacing seals in the base cylinder, it is recommended that the lock unit be separated from the base cylinder so that replacement work can be done on the cylinder alone. Refer to separate instructions for seal replacement.

4. Never disassemble the lock unit.

- A heavy duty spring is contained in part of the unit, which presents a serious hazard if disassembly is performed incorrectly.
- In addition, the lock unit is adjusted before shipment. If readjustment is not performed correctly after reassembly, a serious danger will be created, as performance will not meet specifications.

CLJ2

CLM2

CLG1

CL1

MLGC

CNG

MNB

CNA2

CNS

CLS

CLQ

RLQ

MLU

MLGP

ML1C

D-

-X