

# Compact Cylinder/Guide Rod Type

## CQM Series

ø12, ø16, ø20, ø25, ø32, ø40, ø50, ø63, ø80, ø100



**Lateral load resisting**  
**2 to 4** times  
 \* Compared to compact cylinder the CQ series

**Non-rotating accuracy**  
 $\pm 0.2^\circ$  or less  
 Refer to page 1008 for details.

**Load can be directly mounted.**

**Mounting dimensions compatible with the CQS, CQ2 series.**

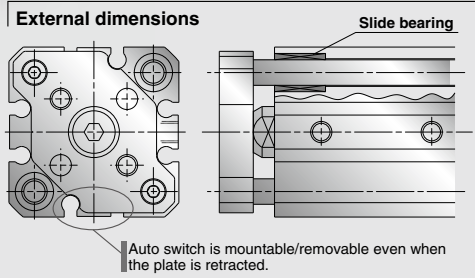

- CJ
- CU
- CQS
- JCQ
- CQ2
- RQ
- CQM**
- CQU
- MU

- D-
- X
- Technical Data

### Series Variations

Series	Bore size (mm)	Standard stroke (mm)										Cushion				
		5	10	15	20	25	30	35	40	45	50		75	100		
CQM	12, 16	●	●	●	●	●	●	●	●	●	●	●	●	●	●	Rubber bumper
	20, 25	●	●	●	●	●	●	●	●	●	●	●	●	●	●	
	32, 40	●	●	●	●	●	●	●	●	●	●	●	●	●	●	
	50, 63, 80, 100	●	●	●	●	●	●	●	●	●	●	●	●	●	●	

# Compact Cylinder: Guide Rod Type

# CQM Series

ø12, ø16, ø20, ø25, ø32, ø40, ø50, ø63, ø80, ø100

## How to Order

CQM **B** **20** - **15**

With auto switch

CDQM **B** **20** - **15** - **M9BW**

With auto switch  
(Built-in magnet)

Mounting bracket

<b>B</b>	Through-hole (Standard)
<b>A</b>	Both ends tapped (ø32 to ø100)

Note 1) Cylinder bodies of ø12 to ø25 are common for both B (through hole) and A (both ends tapped) types. Symbol to order is unified to "B" for those sizes.

Note 2) Cylinder mounting bolts are not included. Order them separately referring to Mounting Bolts for CQM on pages 1010 and 1011.

Note 3) Contact SMC for the other mounting types.

Bore size

<b>12</b>	12 mm	<b>40</b>	40 mm
<b>16</b>	16 mm	<b>50</b>	50 mm
<b>20</b>	20 mm	<b>63</b>	63 mm
<b>25</b>	25 mm	<b>80</b>	80 mm
<b>32</b>	32 mm	<b>100</b>	100 mm

Number of auto switches

<b>Nil</b>	2 pcs.
<b>S</b>	1 pc.
<b>n</b>	"n" pcs.

Auto switch type

<b>Nil</b>	Without auto switch
------------	---------------------

\* Refer to the table below for the applicable auto switch model.

Cylinder stroke (mm)

Refer to page 1007 for standard and intermediate strokes.

Thread type

<b>Nil</b>	M thread	ø12 to ø25
	Rc	
<b>TN</b>	NPT	ø32 to ø100
<b>TF</b>	G	

Note) M thread to be used for without auto switch type of ø32, 5 stroke exceptionally. There is no need to enter the symbol when ordering.

## Built-in Magnet Cylinder Model

If a built-in magnet cylinder without an auto switch is required, there is no need to enter the symbol for the auto switch. (Example) CDQMB32-10

## Applicable Auto Switches

Refer to pages 1575 to 1701 for further information on auto switches.

Type	Special function	Electrical entry	Indicator/light	Wiring (Output)	Load voltage		Auto switch model				Lead wire length (m)				Pre-wired connector	Applicable load		
					DC	AC	Perpendicular		In-line		0.5 (Nil)	1 (M)	3 (L)	5 (Z)		None (N)	IC circuit	Relay, PLC
							ø12 to ø25	ø32 to ø100	ø12 to ø25	ø32 to ø100								
Solid state auto switch	Grommet	Connector	No	3-wire (NPN)	24 V	—	5 V, 12 V	M9NV	M9N	●	●	○	○	○	—	—		
				3-wire (PNP)				M9PV	M9P	●	●	●	○	○				
				2-wire				M9BV	M9B	●	●	○	○	○				
				—				J79C	—	—	●	—	●	●			—	
	Grommet	Yes	Grommet	Yes	3-wire (NPN)	24 V	—	5 V, 12 V	M9NWV	M9NW	●	●	○	○	○	—	IC circuit	
					3-wire (PNP)				M9PWV	M9PW	●	●	●	○	○			
					2-wire				M9BWW	M9BW	●	●	●	○	○			
					3-wire (NPN)				M9NAV*1	M9NA*1	○	○	○	○	○			
					3-wire (PNP)				M9PAV*1	M9PA*1	○	○	●	○	○			
					2-wire				M9BAV*1	M9BA*1	○	○	●	○	○			
4-wire	—	—	—	F79F	●	—	●	○	○	—	IC circuit							
2-wire (Non-polar)	—	—	—	P4DW**	—	—	●	●	○									
Reed auto switch	Grommet	Connector	Yes	3-wire (NPN equiv.)	24 V	—	5 V	A96V	A96	●	—	●	—	—	—	IC circuit		
								—	200 V	A72	A72H	●	—	●			—	—
								12 V	100 V	A93V*2	A93	●	●	●			●	—
								5 V, 12 V	100 V or less	A90V	A90	●	—	●			—	—
								12 V	—	A73C	—	●	—	●			●	●
								5 V, 12 V	24 V or less	A80C	—	●	—	●			●	●
								—	—	A79W	—	●	—	●			—	—

\*1 Water resistant type auto switches can be mounted on the above models, but in such case SMC cannot guarantee water resistance.

Consult with SMC regarding water resistant types with the above model numbers.

\*2 1 m type lead wire is only applicable to D-A93.

\* Lead wire length symbols: 0.5 m..... Nil (Example) M9NV  
1 m..... M (Example) M9NWM  
3 m..... L (Example) M9NWL  
5 m..... Z (Example) M9NWZ  
None..... N (Example) J79CN

\* Solid state auto switches marked with a "○" are produced upon receipt of order.

\*\* D-P4DWL type is compatible with bore sizes ø40 to ø100.

\* Only D-P4DW type is assembled when shipped.

\* Besides the models in the above catalog, there are some other auto switches that are applicable. For more information, refer to page 1017.

\* Refer to pages 1648 and 1649 for the details of auto switches with a pre-wired connector.

\* When mounting D-A9C(V)/M9C(V)/M9C(W)/M9C(A/V) types on a side other than the port side with ø32 to ø50 cylinders, order auto switch mounting brackets separately. Refer to page 1017 for details.



## ⚠ Caution

- ① Do not use the product as a stopper.
- ② Do not disassemble and modify the product.

## Symbol

Rubber bumper

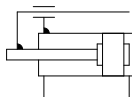

## Specifications

Bore size (mm)	12	16	20	25	32	40	50	63	80	100
<b>Model</b>	Pneumatic (non-lube) type									
<b>Action</b>	Double acting, Single rod									
<b>Fluid</b>	Air									
<b>Proof pressure</b>	1.5 MPa									
<b>Maximum operating pressure</b>	1.0 MPa									
<b>Minimum operating pressure</b>	0.12 MPa					0.1 MPa				
<b>Ambient and fluid temperature</b>	Without auto switch: -10°C to 70°C (No freezing) With auto switch: -10°C to 60°C (No freezing)									
<b>Cushion</b>	Rubber bumper on both ends									
<b>Stroke length tolerance</b>	+1.0 mm* 0									
<b>Mounting</b>	Through-holes									
<b>Piston speed</b>	50 to 500 mm/s					50 to 300 mm/s				

\* Stroke length tolerance does not include the amount of dumper change.

## Standard Stroke

Bore size (mm)	Standard stroke (mm)
<b>12,16</b>	5, 10, 15, 20, 25, 30
<b>20,25</b>	5, 10, 15, 20, 25, 30, 35, 40, 45, 50
<b>32,40</b>	5, 10, 15, 20, 25, 30, 35, 40, 45, 50, 75, 100
<b>50,63,80,100</b>	10, 15, 20, 25, 30, 35, 40, 45, 50, 75, 100

## Manufacture of Intermediate Stroke

Description		Intermediate stroke range	
Spacers are installed in a cylinder with standard stroke.		Bore size (mm)	Intermediate stroke range (mm)
		<b>12, 16</b>	1 to 29
		<b>20, 25</b>	1 to 49
		<b>32</b>	1 to 99
		<b>40 to 100</b>	5 to 95

Example) Part number: CQMB32-57

Constructed by installing an 18 mm spacer in the standard stroke cylinder CQMB32-75. B dimension: 108 mm.

## Theoretical Output

Bore size (mm)	Operating direction	Operating pressure (MPa)		
		0.3	0.5	0.7
<b>12</b>	IN	25	42	59
	OUT	34	57	79
<b>16</b>	IN	45	75	106
	OUT	60	101	141
<b>20</b>	IN	71	118	165
	OUT	94	157	220
<b>25</b>	IN	113	189	264
	OUT	147	245	344
<b>32</b>	IN	181	302	422
	OUT	241	402	563
<b>40</b>	IN	317	528	739
	OUT	377	628	880
<b>50</b>	IN	495	825	1150
	OUT	589	982	1370
<b>63</b>	IN	840	1400	1960
	OUT	936	1560	2184
<b>80</b>	IN	1362	2270	3178
	OUT	1509	2515	3521
<b>100</b>	IN	2145	3575	5005
	OUT	2355	3925	5495

## Auto Switch Mounting Bracket Weight

Mounting bracket part no.	Applicable cylinder bore size	Weight (g)
BQ-2	ø32 to ø100	1.5
BQP1-050	ø40 to ø100	16

## Weight

### Without Auto Switch

Bore size (mm)	Cylinder stroke (mm)											
	5	10	15	20	25	30	35	40	45	50	75	100
<b>12</b>	44	52	60	69	77	86	—	—	—	—	—	—
<b>16</b>	56	67	77	87	97	108	—	—	—	—	—	—
<b>20</b>	92	107	122	137	152	167	183	198	213	227	—	—
<b>25</b>	125	143	162	180	198	216	234	252	270	288	—	—
<b>32</b>	182	205	228	250	274	297	320	343	366	389	553	669
<b>40</b>	269	295	320	345	370	396	421	446	471	497	692	823
<b>50</b>	—	500	540	580	620	661	701	740	780	821	1133	1341
<b>63</b>	—	745	795	845	894	944	993	1043	1093	1143	1535	1791
<b>80</b>	—	1400	1479	1559	1639	1719	1800	1880	1959	2039	2671	3067
<b>100</b>	—	2365	2468	2571	2674	2776	2880	2983	3086	3188	4053	4574

### With Auto Switch (Built-in magnet)

Bore size (mm)	Cylinder stroke (mm)											
	5	10	15	20	25	30	35	40	45	50	75	100
<b>12</b>	52	59	68	77	84	93	—	—	—	—	—	—
<b>16</b>	66	77	87	97	107	118	—	—	—	—	—	—
<b>20</b>	122	138	153	168	182	197	213	227	242	257	—	—
<b>25</b>	168	186	205	223	240	258	277	295	313	331	—	—
<b>32</b>	241	264	287	309	333	356	379	401	425	448	564	680
<b>40</b>	345	371	396	421	447	473	498	523	548	574	705	836
<b>50</b>	—	618	658	698	738	779	819	858	898	939	1147	1355
<b>63</b>	—	903	953	1003	1052	1102	1152	1201	1251	1301	1557	1813
<b>80</b>	—	1661	1740	1820	1900	1980	2061	2141	2220	2300	2695	3090
<b>100</b>	—	2745	2848	2950	3053	3156	3260	3362	3465	3568	4088	4609

Add each weight of auto switches and mounting brackets.  
Refer to pages 1575 to 1701 for auto switch weight.

## Plate Non-rotating Accuracy

Non-rotating accuracy without load is designed to be same or less than the figures shown in the table below at the retracted cylinder end (plate).

Bore size (mm)	Non-rotating accuracy
12, 16	±0.2°
20 to 100	±0.1°

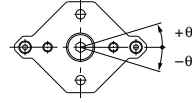

## Plate Allowable Rotational Torque

**Make sure to operate strictly within the allowable rotation torque range to the plate.**

Operation outside of this range may result in shorter service life or damage to the device.

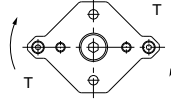

Unit: N·m

Bore size (mm)	Cylinder stroke (mm)											
	5	10	15	20	25	30	35	40	45	50	75	100
12	0.11	0.10	0.08	0.07	0.07	0.06	—	—	—	—	—	—
16	0.15	0.12	0.11	0.10	0.09	0.08	—	—	—	—	—	—
20	0.37	0.32	0.28	0.25	0.23	0.21	0.19	0.18	0.17	0.16	—	—
25	0.40	0.35	0.31	0.28	0.25	0.23	0.21	0.20	0.18	0.17	—	—
32	0.66	0.59	0.53	0.49	0.45	0.42	0.39	0.36	0.34	0.32	0.25	0.20
40	1.06	0.96	0.88	0.81	0.75	0.70	0.65	0.61	0.58	0.55	0.43	0.36
50	—	1.70	1.56	1.45	1.35	1.26	1.19	1.12	1.06	1.01	0.80	0.67
63	—	3.90	3.62	3.37	3.15	2.96	2.80	2.65	2.51	2.39	1.92	1.61
80	—	7.44	6.98	6.56	6.20	5.87	5.57	5.31	5.07	4.84	3.98	3.37
100	—	11.85	11.19	10.61	10.08	9.60	9.17	8.77	8.41	8.07	6.73	5.77

## Plate Allowable Lateral Load

**Make sure to operate strictly within the allowable lateral load range to the plate.**

Operation outside of this range may result in shorter service life or damage to the device.

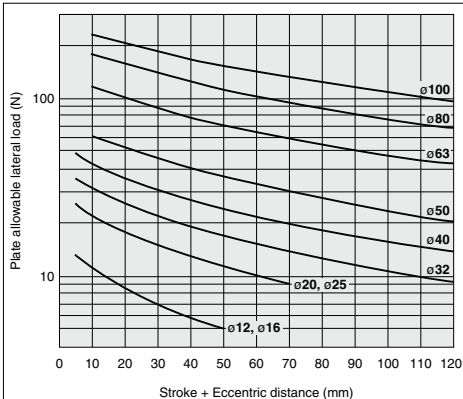
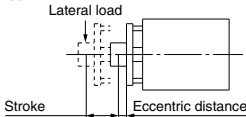

## Allowable Kinetic Energy

**Make sure to operate strictly within the allowable range of the load mass and maximum speed.**

Operation outside of this range may cause excessive impact, which may result in the damage to the device.

Operating pressure: 0.5 MPa

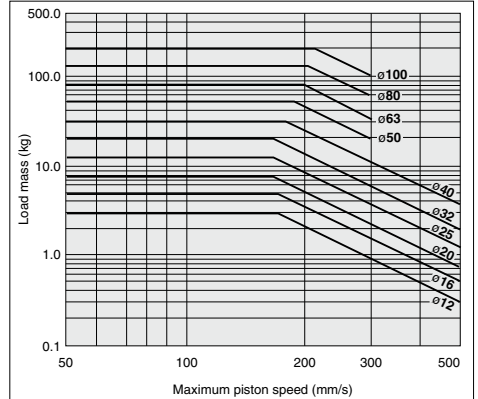

**Construction**

ø12 to ø25

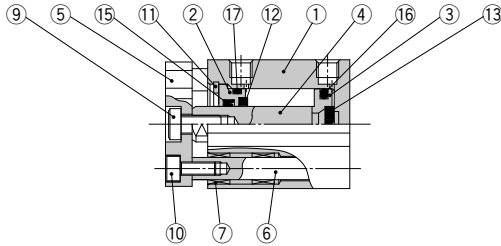

With auto switch  
(Built-in magnet)

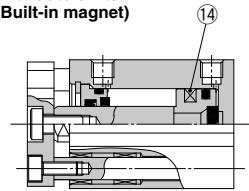

ø32 to ø100

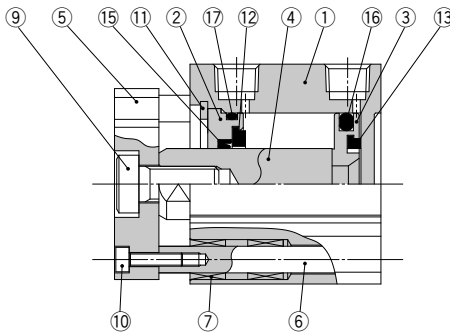

With auto switch  
(Built-in magnet)

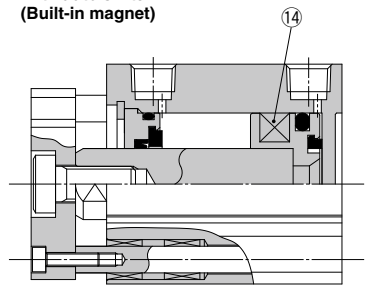

ø50 to ø100

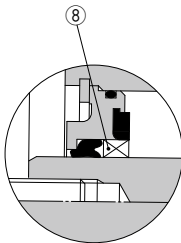

**Component Parts**

No.	Description	Material	Note
1	Cylinder tube	Aluminum alloy	Hard anodized
2	Collar	Aluminum alloy	ø12 to ø40 Anodized
		Aluminum alloy casted	ø50 to ø100 Chromated, Coated
3	Piston	Aluminum alloy	
4	Piston rod	Stainless steel	ø12 to ø25
		Carbon steel	ø32 to ø100 Hard chrome plated
5	Plate	Aluminum alloy	Anodized
6	Guide rod	Stainless steel	
7	Bushing	Bearing alloy	
8	Bushing	Bearing alloy	ø50 to ø100
9	Hexagon socket head cap screw	Carbon steel	Zmc chromated
10	Hexagon socket head cap screw	Carbon steel	Zmc chromated
11	Retaining ring	Carbon tool steel	Phosphate coated
12	Bumper A	Urethan	
13	Bumper B	Urethan	
14	Magnet	—	
15	Rod seal	NBR	
16	Piston seal	NBR	
17	Gasket	NBR	

CUJ

CU

CQS

JCQ

CQ2

RQ

**CQM**

CQU

MU

D-□

-X□

Technical  
Data

# CQM Series

## Mounting Bolt

Mounting method: Mounting bolt for through-hole type of C(D)MB is available as an option.

Refer to the following for ordering procedures.  
Order the actual number of bolts that will be used.

**Example) CQ-M3x25L 2 pcs.**

Material: Chromium molybdenum steel  
Surface treatment: Zinc chromated

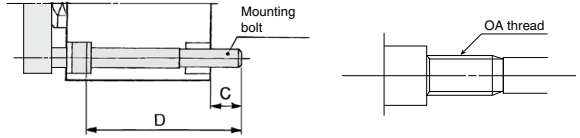

Note) To install a cylinder with bore size 12 to 25 mm with through-hole, be sure to use the attached flat washer.

## Mounting Bolt for CQM/Without Auto Switch

Cylinder model	C	D	Mounting bolt part no.
<b>CQMB12- 5</b>	6.5	25	CQ-M3 x 25L
-10		30	x 30L
-15		35	x 35L
-20		40	x 40L
-25		45	x 45L
-30		50	x 50L
<b>CQMB16- 5</b>	6.5	25	CQ-M3 x 25L
-10		30	x 30L
-15		35	x 35L
-20		40	x 40L
-25		45	x 45L
-30		50	x 50L
<b>CQMB20- 5</b>	6.5	25	CQ-M5 x 25L
-10		30	x 30L
-15		35	x 35L
-20		40	x 40L
-25		45	x 45L
-30		50	x 50L
-35		55	x 55L
-40		60	x 60L
-45		65	x 65L
-50		70	x 70L
<b>CQMB25- 5</b>	8.5	30	CQ-M5 x 30L
-10		35	x 35L
-15		40	x 40L
-20		45	x 45L
-25		50	x 50L
-30		55	x 55L
-35		60	x 60L
-40		65	x 65L
-45		70	x 70L
-50		75	x 75L

Cylinder model	C	D	Mounting bolt part no.	
<b>CQMB32- 5</b>	9	30	CQ-M5 x 30L	
-10		35	x 35L	
-15		40	x 40L	
-20		45	x 45L	
-25		50	x 50L	
-30		55	x 55L	
-35		60	x 60L	
-40		65	x 65L	
-45		70	x 70L	
-50		75	x 75L	
-75		110	x 110L	
-100		135	x 135L	
<b>CQMB40- 5</b>		7.5	35	CQ-M5 x 35L
-10			40	x 40L
-15	45		x 45L	
-20	50		x 50L	
-25	55		x 55L	
-30	60		x 60L	
-35	65		x 65L	
-40	70		x 70L	
-45	75		x 75L	
-50	80		x 80L	
-75	115		x 115L	
-100	140		x 140L	
<b>CQMB50- 10</b>	12.5		45	CQ-M6 x 45L
-15			50	x 50L
-20		55	x 55L	
-25		60	x 60L	
-30		65	x 65L	
-35		70	x 70L	
-40		75	x 75L	
-45		80	x 80L	
-50		85	x 85L	
-75		120	x 120L	
-100		145	x 145L	

Cylinder model	C	D	Mounting bolt part no.
<b>CQMB63- 10</b>	14.5	50	CQ-M8 x 50L
-15		55	x 55L
-20		60	x 60L
-25		65	x 65L
-30		70	x 70L
-35		75	x 75L
-40		80	x 80L
-45		85	x 85L
-50		90	x 90L
-75		125	x 125L
<b>CQMB80- 10</b>	15	55	CQ-M10 x 55L
-15		60	x 60L
-20		65	x 65L
-25		70	x 70L
-30		75	x 75L
-35		80	x 80L
-40		85	x 85L
-45		90	x 90L
-50		95	x 95L
-75		130	x 130L
<b>CQMB100- 10</b>	15.5	65	CQ-M10 x 65L
-15		70	x 70L
-20		75	x 75L
-25		80	x 80L
-30		85	x 85L
-35		90	x 90L
-40		95	x 95L
-45		100	x 100L
-50		105	x 105L
-75		140	x 140L
-100	165	x 165L	

**Mounting Bolt for CDQM/With Auto Switch (Built-in magnet)**

Cylinder model	C	D	Mounting bolt part no.
<b>CDQMB12- 5</b>	6.5	30	CQ-M3 x 30L
<b>-10</b>		35	x 35L
<b>-15</b>		40	x 40L
<b>-20</b>		45	x 45L
<b>-25</b>		50	x 50L
<b>-30</b>		55	x 55L
<b>CDQMB16- 5</b>	6.5	30	CQ-M3 x 30L
<b>-10</b>		35	x 35L
<b>-15</b>		40	x 40L
<b>-20</b>		45	x 45L
<b>-25</b>		50	x 50L
<b>-30</b>		55	x 55L
<b>CDQMB20- 5</b>	6.5	35	CQ-M5 x 35L
<b>-10</b>		40	x 40L
<b>-15</b>		45	x 45L
<b>-20</b>		50	x 50L
<b>-25</b>		55	x 55L
<b>-30</b>		60	x 60L
<b>-35</b>		65	x 65L
<b>-40</b>		70	x 70L
<b>-45</b>		75	x 75L
<b>-50</b>		80	x 80L
<b>CDQMB25- 5</b>	8.5	40	CQ-M5 x 40L
<b>-10</b>		45	x 45L
<b>-15</b>		50	x 50L
<b>-20</b>		55	x 55L
<b>-25</b>		60	x 60L
<b>-30</b>		65	x 65L
<b>-35</b>		70	x 70L
<b>-40</b>		75	x 75L
<b>-45</b>	80	x 80L	
<b>-50</b>	85	x 85L	

Cylinder model	C	D	Mounting bolt part no.
<b>CDQMB32- 5</b>	9	40	CQ-M5 x 40L
<b>- 10</b>		45	x 45L
<b>- 15</b>		50	x 50L
<b>- 20</b>		55	x 55L
<b>- 25</b>		60	x 60L
<b>- 30</b>		65	x 65L
<b>- 35</b>		70	x 70L
<b>- 40</b>		75	x 75L
<b>- 45</b>		80	x 80L
<b>- 50</b>		85	x 85L
<b>- 75</b>	110	x 110L	
<b>-100</b>	135	x 135L	
<b>CDQMB40- 5</b>	7.5	45	CQ-M5 x 45L
<b>- 10</b>		50	x 50L
<b>- 15</b>		55	x 55L
<b>- 20</b>		60	x 60L
<b>- 25</b>		65	x 65L
<b>- 30</b>		70	x 70L
<b>- 35</b>		75	x 75L
<b>- 40</b>		80	x 80L
<b>- 45</b>		85	x 85L
<b>- 50</b>		90	x 90L
<b>- 75</b>	115	x 115L	
<b>-100</b>	140	x 140L	
<b>CDQMB50- 10</b>	12.5	55	CQ-M6 x 55L
<b>- 15</b>		60	x 60L
<b>- 20</b>		65	x 65L
<b>- 25</b>		70	x 70L
<b>- 30</b>		75	x 75L
<b>- 35</b>		80	x 80L
<b>- 40</b>		85	x 85L
<b>- 45</b>		90	x 90L
<b>- 50</b>		95	x 95L
<b>- 75</b>		120	x 120L
<b>-100</b>	145	x 145L	

Cylinder model	C	D	Mounting bolt part no.
<b>CDQMB63- 10</b>	14.5	60	CQ-M8 x 60L
<b>- 15</b>		65	x 65L
<b>- 20</b>		70	x 70L
<b>- 25</b>		75	x 75L
<b>- 30</b>		80	x 80L
<b>- 35</b>		85	x 85L
<b>- 40</b>		90	x 90L
<b>- 45</b>		95	x 95L
<b>- 50</b>		100	x 100L
<b>- 75</b>		125	x 125L
<b>-100</b>	150	x 150L	
<b>CDQMB80- 10</b>	15	65	CQ-M10 x 65L
<b>- 15</b>		70	x 70L
<b>- 20</b>		75	x 75L
<b>- 25</b>		80	x 80L
<b>- 30</b>		85	x 85L
<b>- 35</b>		90	x 90L
<b>- 40</b>		95	x 95L
<b>- 45</b>		100	x 100L
<b>- 50</b>		105	x 105L
<b>- 75</b>		130	x 130L
<b>-100</b>	155	x 155L	
<b>CDQMB100- 10</b>	15.5	75	CQ-M10 x 75L
<b>- 15</b>		80	x 80L
<b>- 20</b>		85	x 85L
<b>- 25</b>		90	x 90L
<b>- 30</b>		95	x 95L
<b>- 35</b>		100	x 100L
<b>- 40</b>		105	x 105L
<b>- 45</b>		110	x 110L
<b>- 50</b>		115	x 115L
<b>- 75</b>		140	x 140L
<b>-100</b>	165	x 165L	

**CUJ**

**CU**

**CQS**

**JCQ**

**CQ2**

**RQ**

**CQM**

**CQU**

**MU**

**D-□**

**-X□**

Technical  
Data

# CQM Series

## Dimensions

ø12 to ø25

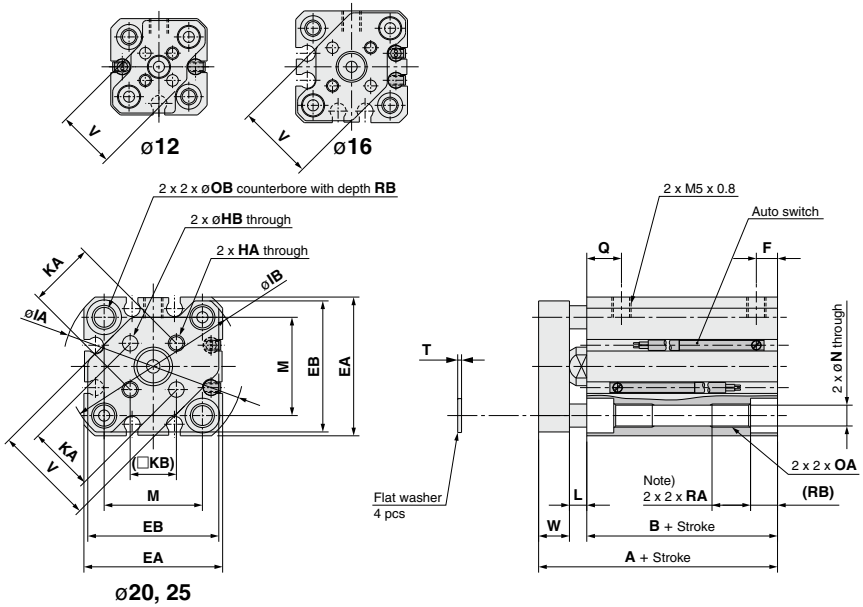

(mm)

Bore size (mm)	Stroke range (mm)	Without auto switch		With auto switch		EA	EB	F	HA	OA	HB	IA	IB
		A	B	A	B								
12	5 to 30	26.5	17	31.5	22	25	24	5	M3 x 0.5	M4 x 0.7	3 <sup>+0.2</sup> <sub>0</sub>	32	31.5
16	5 to 30	26.5	17	31.5	22	29	28	5	M3 x 0.5	M4 x 0.7	3 <sup>+0.2</sup> <sub>0</sub>	38	37
20	5 to 50	32	19.5	42	29.5	36	34	5.5	M4 x 0.7	M6 x 1.0	4 <sup>+0.2</sup> <sub>0</sub>	47	45.5
25	5 to 50	35.5	22.5	45.5	32.5	40	38	5.5	M5 x 0.8	M6 x 1.0	5 <sup>+0.2</sup> <sub>0</sub>	52	50.5

Bore size (mm)	KA	KB	L	M	N	OB	Q	RA	RB	T	V	W
12	10 ± 0.1	7.1	3.5	15.5	3.5	6.5	7.5	7	4	0.5	14.9	6
16	14 ± 0.1	9.9	3.5	20	3.5	6.5	7.5	7	4	0.5	20	6
20	17 ± 0.1	12	4.5	25.5	5.4	9	9	10	7	1	26	8
25	22 ± 0.1	15.6	5	28	5.4	9	11	10	7	1	30	8

Note) For the following bore/stroke sizes, the through-hole is threaded.  
 Standard without auto switch: ø12 and ø16; 5 stroke, ø20; 5 to 15 stroke, ø25; 5 and 10 stroke, Built-in magnet with auto switch: ø20; 5 stroke



**Dimensions**

ø32 to ø50

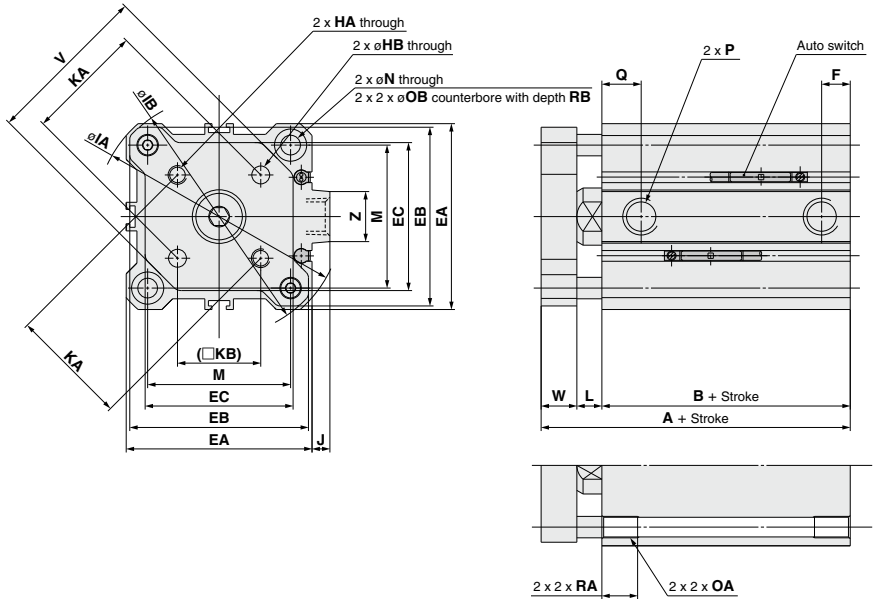

Both ends tapped (CQMA)

Bore size (mm)	Stroke range (mm)	Without auto switch								With auto switch								EA	EB	EC
		A	B	F	Q	P			A	B	F	Q	P							
						—	TN	TF					—	TN	TF					
32	5	40	23	5.5	11.5	M5 x 0.8	—	—	50	33	7.5	10.5	Rc 1/8	NPT 1/8	G 1/8	45	43	34.4		
	10 to 50			7.5	10.5	Rc 1/8	NPT 1/8	G 1/8												
	75, 100	50	33	8	11	Rc 1/8	NPT 1/8	G 1/8	56.5	39.5	8	11	Rc 1/8	NPT 1/8	G 1/8	52	50	41.4		
40	5 to 50	46.5	29.5	8	11	Rc 1/8	NPT 1/8	G 1/8	56.5	39.5	8	11	Rc 1/8	NPT 1/8	G 1/8	52	50	41.4		
	75, 100	56.5	39.5																	
50	10 to 50	50.5	30.5	10.5	10.5	Rc 1/4	NPT 1/4	G 1/4	60.5	40.5	10.5	10.5	Rc 1/4	NPT 1/4	G 1/4	64	62	53.4		
	75, 100	60.5	40.5																	

Bore size (mm)	HA	OA	HB	IA	IB	J	KA	KB	L	M	N	OB	RA	RB	V	W	Z
32	M5 x 0.8	M6 x 1.0	5 <sup>+0.2</sup> <sub>0</sub>	60	58.5	4.5	28 ± 0.2	19.8	7	34	5.5	9	10	7	38	10	14
40	M5 x 0.8	M6 x 1.0	5 <sup>+0.2</sup> <sub>0</sub>	69	67.5	5	33 ± 0.2	23.3	7	40	5.5	9	10	7	46	10	14
50	M6 x 1.0	M8 x 1.25	6 <sup>+0.2</sup> <sub>0</sub>	86	84.5	7	42 ± 0.2	29.7	8	50	6.6	11	14	8	58	12	19

- CUJ**
- CU**
- CQS**
- JCQ**
- CQ2**
- RQ**
- CQM**
- CQU**
- MU**

- D-□**
- X□**
- Technical Data

# CQM Series

## Dimensions

ø63 to ø100

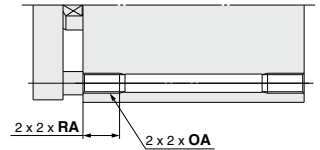
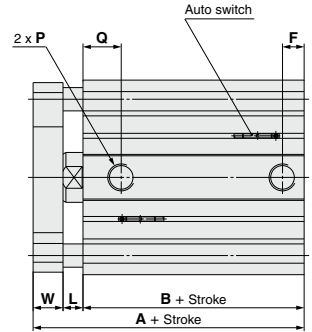
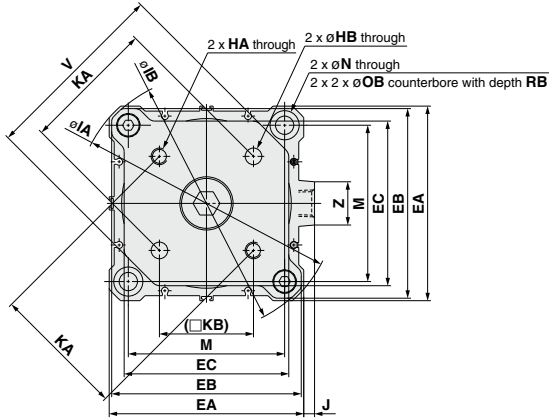

Both ends tapped (CQMA)

(mm)

Bore size (mm)	Stroke range (mm)	Without auto switch		With auto switch		EA	EB	EC	F	HA	HB	IA	IB	J	KA	KB	L	M
		A	B	A	B													
63	10 to 50	56	36	66	46	77	74	59.6	10.5	M6 x 1	6 <sup>+0.2</sup> <sub>0</sub>	103	100	7	50 ± 0.2	35.4	8	60
	75, 100	66	46															
80	10 to 50	67.5	43.5	77.5	53.5	98	95	79.5	12.5	M8 x 1.25	8 <sup>+0.2</sup> <sub>0</sub>	132	129	6	65 ± 0.2	46	10	77
	75, 100	77.5	53.5															
100	10 to 50	79	53	89	63	117	114	99	13	M10 x 1.5	10 <sup>+0.2</sup> <sub>0</sub>	156	153	6.5	80 ± 0.2	56.6	10	94
	75, 100	89	63															

Bore size (mm)	N	OA	OB	P			Q	RA	RB	V	W	Z
				—	TN	TF						
63	9	M10 x 1.5	14	Rc 1/4	NPT 1/4	G 1/4	15	18	10.5	69	12	19
80	11	M12 x 1.75	17.5	Rc 3/8	NPT 3/8	G 3/8	16	22	13.5	89	14	26
100	11	M12 x 1.75	17.5	Rc 3/8	NPT 3/8	G 3/8	23	22	13.5	113	16	26

# CQM Series Auto Switch Mounting 1

## Minimum Auto Switch Mounting Stroke

Bore size (mm)	Auto switch model No. of auto switch mounted	(mm)																									
		D-M9□V	D-A9□V	D-A9□	D-M9□WV	D-M9□	D-M9□W	D-M9□A	D-F7□V	D-F79C	D-A7□	D-A8□	D-A73C	D-A80C	D-F7□WV	D-F7BAV	D-F7□	D-J79	D-A7□H	D-A80H	D-A79W	D-F7□W	D-J79W	D-F7BA	D-F7NT	D-F79F	D-P4DW
12, 16, 20, 25	1 pc. 2 pcs.	5 5	5 10	10(5) 10	10 10	15(5) 15(5)	15(10) 15(10)	— —	— —	— —	— —	— —	— —	— —	— —	— —	— —	— —	— —	— —	— —	— —	— —	— —	— —	— —	— —
32, 40, 50, 63, 80, 100	1 pc. 2 pcs.	5 5	5 10	10(5) 10	10 15	10(5) 10(5)	15(10) 15	5 5	5 10	10 15	15(15) 15(5)	15(5) 15(10)	15(5) 15(10)	15(5) 15(10)	15(5) 15(10)	15(5) 15(10)	15(5) 15(10)	15 20	20(10) 20(15)	15 20	20(15) 20(15)	15 15	— —	— —	— —	— —	— —

\* D-P4DWL type is compatible with bore sizes ø40 to ø100.

Note) The dimension stated in ( ) shows the minimum mountable stroke when the auto switch does not project from the end face of the cylinder body and the lead wire bending space is not hindered. (Refer to the figure below.)

The auto switch and its mounting bracket are ordered separately. (Bore sizes ø12 to ø25 do not need any auto switch mounting bracket.)



## Proper Auto Switch Mounting Position (Detection at stroke end) and Its Mounting Height

D-A9□  
D-M9□

ø12

D-M9□W  
D-M9□A

ø16, 20, 25

D-A9□V  
D-M9□V  
D-M9□WV  
D-M9□AV

ø32 to ø100

Approx. Hs

Approx. Hs

Approx. Hs

## Proper Auto Switch Mounting Positions

Auto switch model Bore size	D-A9□ D-A9□V			D-M9□ D-M9□V D-M9□W D-M9□WV			D-M9□A D-M9□AV		
	A	B	W	A	B	W	A	B	W
12	1.5	0.5	1.5 (4)	5.5	4.5	5.5	5.5	4.5	7.5
16	2	0	2 (4.5)	6	4	6	6	4	8
20	6	3.5	-1.5 (1)	10	7.5	2.5	10	7.5	4.5
25	7	5.5	-3.5 (-1)	11	9.5	0.5	11	9.5	2.5
32	8	5	-3 (-0.5)	12	9	1	12	9	3
40	12	7.5	-5.5 (-3)	16	11.5	-1.5	16	11.5	0.5
50	10	10.5	-8.5 (-6)	14	14.5	-4.5	14	14.5	-2.5
63	12.5	13.5	-11.5 (-9)	16.5	17.5	-7.5	16.5	17.5	-5.5
80	15.5	18	-16 (-13.5)	19.5	22	-12	19.5	22	-10
100	20	23	-21 (-18.5)	24	27	-17	24	27	-15

Note 1) ( ) : For D-A93 type

Note 2) W is used for mounting D-A9□, D-M9□, D-M9□W and D-M9□A types.

Note 3) Negative figures for W in the table indicate that an auto switch is mounted inward from the edge of the cylinder body.

Note 4) Adjust the auto switch after confirming the operating condition in the actual setting.

## Auto Switch Mounting Height

Auto switch model Bore size	D-A9□V D-M9□V D-M9□WV D-M9□AV	
	Hs	Hs
12	17	19
16	19	21
20	22.5	24
25	24.5	26
32	27	29
40	30.5	32.5
50	36.5	42
63	40	42
80	50	52
100	60	62

CUJ

CU

CQS

JCQ

CQ2

RQ

CQM

CQU

MU

D-□

-X□

Technical Data

# Auto Switch Mounting 2

## Proper Auto Switch Mounting Position (Detection at stroke end) and Its Mounting Height

- |        |         |        |        |
|--------|---------|--------|--------|
| D-A7□  | D-F7□V  | D-A7□H | D-F7□  |
| D-A80  | D-J79C  | D-A80H | D-J79  |
| D-A73C | D-F7□WV |        | D-F7□W |
| D-A80C | D-F7BAV |        | D-J79W |
| D-A79W |         |        | D-F7BA |
|        |         |        | D-F79F |
|        |         |        | D-F7NT |

D-P4DW

ø40 to ø100

ø32 to ø100

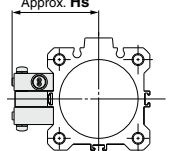
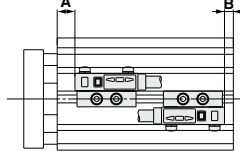
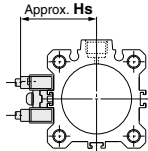
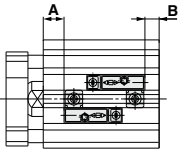

## Proper Auto Switch Mounting Position

(mm)

Auto switch model	D-A73 D-A80		D-A72/A7□H/A80H D-A73C/A80C/F7□ D-J79/F7□W/J79W D-F7□V/F7□WV D-F79F/J79C D-F7BA/F7BAV		D-F7NT		D-A79W		D-P4DW	
	A	B	A	B	A	B	A	B	A	B
Bore size 32	9	6	9.5	6.5	14.5	11.5	6.5	3.5	—	—
40	13	8.5	13.5	9	18.5	14	10.5	6	9	4.5
50	11	11.5	11.5	12	16.5	17	12	8.5	7	7.5
63	13	14.5	14	15	15	16	11	12	9.5	10.5
80	17	18	18	18.5	19	19.5	15	15.5	13.5	14
100	21	24	21.5	24.5	22.5	25.5	18.5	21.5	17	20

\* D-P4DWL type is compatible with bore sizes ø40 to ø100.

Note) Adjust the auto switch after confirming the operating condition in the actual setting.

## Auto Switch Mounting Height

(mm)

Auto switch model	D-A7□ D-A80	D-A7□H/A80H D-F7□/J79/F7□W D-J79W/F79F D-F7BA/F7NT	D-A73C D-A80C	D-A79W	D-F7□V D-F7□WV D-F7BAV	D-J79C	D-P4DW
	Hs	Hs	Hs	Hs	Hs	Hs	Hs
Bore size 32	31.5	32.5	38.5	34	35	38	—
40	35	36	42	37.5	38.5	41.5	44
50	41	42	48	43.5	44.5	47.5	50
63	47.5	48.5	54.5	50	51	54	56.5
80	57.5	58.5	64.5	60	61	64	66.5
100	67.5	68.5	74.5	70	71	74	76.5

\* D-P4DWL type is compatible with bore sizes ø40 to ø100.

## Operating Range

(mm)

Auto switch model	Bore size									
	12	16	20	25	32	40	50	63	80	100
D-A9□/A9□V	6	7.5	10	10	9.5	9.5	9.5	11.5	9	11.5
D-M9□/M9□V D-M9□W/M9□WV D-M9□A/M9□AV	3	4	5.5	5.5	6	6	7	7.5	8	8.5
D-A7□/A80	—	—	—	—	12	11	10	12	12	13
D-A79W	—	—	—	—	13	14	14	16	15	17
D-F7□/F7□V D-J79/J79C D-F7□W/F7□WV D-J79W D-F7BA/F7BAV D-F7NT/F79F	—	—	—	—	6	6	6	6.5	6.5	7
D-P4DW	—	—	—	—	—	5	5	5	5	5.5

\* Since the operating range is provided as a guideline including hysteresis, it cannot be guaranteed (assuming approximately ±30% dispersion). It may vary substantially depending on an ambient environment.

\* Auto switch mounting brackets BQ2-012 are not used for sizes over ø32 of D-A9□(V)/M9□(V)/M9□A(V) types.

The above values indicate the operating range when mounted with the current auto switch installation groove.

## Auto Switch Mounting Bracket: Part No.

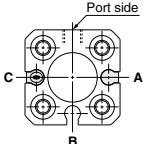
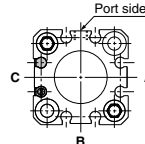
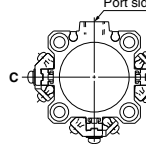
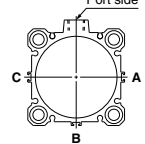
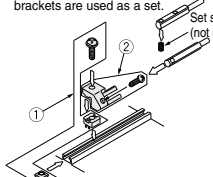
Auto switch mounting surface	Bore size (mm)			
	ø12	ø16, ø20, ø25	ø32, ø40, ø50	ø63, ø80, ø100
				
Auto switch model	Auto switch mounting surface A, B, C sides	Auto switch mounting surface Port, A, B, C sides	Auto switch mounting surface Port side A, B, C sides	Auto switch mounting surface Port, A, B, C sides
<b>D-A9□</b> <b>D-A9□V</b> <b>D-M9□</b> <b>D-M9□V</b> <b>D-M9□W</b> <b>D-M9□WV</b> <b>D-M9□A</b> <b>D-M9□AV</b>	Auto switch mounting bracket not required.	Auto switch mounting bracket not required.	① BQ-2 ② BQ2-012 2 kinds of auto switch mounting brackets are used as a set. 	Auto switch mounting bracket not required.

Note 1) For each cylinder series, when a compact auto switch is mounted on the three sides (A, B and C above) other than the port side of bore sizes ø32 to ø50, the auto switch mounting brackets above are required. Order them separately from cylinders.

Order example  
 CDQMB32-50-M9BW.....1  
 BQ-2.....2 pcs.  
 BQ2-012.....2 pcs.

Note 2) When shipping cylinders, auto switch mounting brackets and auto switches are shipped together.

Auto switch model	Bore size (mm)					
	32	40	50	63	80	100
<b>D-A7□/A80</b> <b>D-A73C/A80C</b> <b>D-A7□H/A80H</b> <b>D-A79W</b> <b>D-F7□/J79</b> <b>D-F7□V</b> <b>D-J79C</b> <b>D-F7□W/J79W</b> <b>D-F7□WV</b> <b>D-F7BA/F7BAV</b> <b>D-F79F/F7NT</b>	BQ-2					
<b>D-P4DW</b>	BQP1-050					

Note 3) Auto switch mounting brackets and auto switches are included when the cylinder is shipped. For only ø40 to ø100 with D-P4DW, they are assembled at the time of shipment.

### [Mounting screw set made of stainless steel]

The following set of mounting screws made of stainless steel (including nuts) is available. Use it in accordance with the operating environment. (Please order BQ-2 separately, since auto switch spacers (for BQ-2) are not included.)

BBA2: For D-A7/A8/F7/J7 types

D-F7BA/F7BAV auto switches are mounted on the cylinder with the stainless steel screws above when shipped. When an auto switch is shipped independently, BBA2 is attached.

Note 4) Refer to page 1685 for the details of BBA2 screws.

Note 5) When D-M9□A(V) type is mounted on a side other than ø32, ø40 and ø50 port sides, order auto switch mounting brackets BQ2-012S and BQ-2, and a stainless steel screw set BBA2.

### Auto Switch Mounting Bracket Weight

Mounting bracket part no.	Weight (g)
BQ-2	1.5
BQ2-012	5
BQP1-050	16

### Other Applicable Auto Switches

Type	Model	Electrical entry (Fetching direction)	Features
<b>Reed auto switch</b>	D-A73	Grommet (perpendicular)	Without indicator light
	D-A80		
	D-A73H, A76H	Grommet (in-line)	Without indicator light
	D-A80H		
<b>Solid state auto switch</b>	D-F7NV, F7PV, F7BV	Grommet (perpendicular)	—
	D-F7NWV, F7BWV		Diagnostic indication (2-color indicator)
	D-F7BAV		Water resistance (2-color indicator)
	D-F79, F7P, J79		—
	D-F79W, F7PW, J79W	Grommet (in-line)	Diagnostic indication (2-color indicator)
	D-F7BA		Water resistance (2-color indicator)
	D-F7NT		With timer
	D-P5DW		Magnetic field resistant (2-color indicator)

- \* For solid state auto switches, auto switches with a pre-wired connector are also available. Refer to pages 1648 and 1649 for details.
- \* Normally closed (NC = b contact) solid state auto switches (D-F9G/F9H types) are also available. Refer to page 1593 for details.
- \* D-A7/A8/F7/J7 types cannot be mounted on ø12 to ø25.

**CUJ**

**CU**

**CQS**

**JCQ**

**CQ2**

**RQ**

**CQM**

**CQU**

**MU**

**D-□**

**-X□**

Technical Data

## Auto Switch Mounting 3

**The number of surfaces and grooves where an auto switch can be mounted (as direct mounting).**

The number of the surfaces and grooves where the auto switch can be mounted, by auto switch type, are shown in the table below.

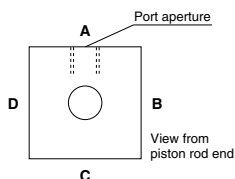

Auto switch type	D-A9□(V), M9□(V), M9□W(V), M9□A(V)				D-A7□, A8□, F7□, J7□			
Bore size (mm)	A (Mounting groove no.)	B (Mounting groove no.)	C (Mounting groove no.)	D (Mounting groove no.)	A (Mounting groove no.)	B (Mounting groove no.)	C (Mounting groove no.)	D (Mounting groove no.)
12	—	○ (1)	○ (1)	○ (1)	—	—	—	—
16	—	○ (2)	○ (2)	○ (2)	—	—	—	—
20	○ (2)	○ (2)	○ (2)	○ (2)	—	—	—	—
25	○ (2)	○ (2)	○ (2)	○ (2)	—	—	—	—
32	○ (2)	—	—	—	—	○	○	○
40	○ (2)	—	—	—	—	○	○	○
50	○ (2)	—	—	—	—	○	○	○
63	○ (2)	○ (2)	○ (2)	○ (2)	—	○	○	○
80	○ (2)	○ (2)	○ (2)	○ (2)	—	○	○	○
100	○ (2)	○ (2)	○ (2)	○ (2)	—	○	○	○



## CQM Series

# Specific Product Precautions

Be sure to read this before handling the products.

Refer to back page 50 for Safety Instructions and pages 3 to 12 for Actuator and Auto Switch Precautions.

### Mounting

#### ⚠ Warning

1. Do not put hands or fingers between the plate and cylinder tubing.

Never put hands or fingers in the gap between the plate and cylinder tubing when the piston rods are retracted. Due to the heavy power output of the cylinder, failure to comply with this directive may result in trapping and subsequent injury to the human body.

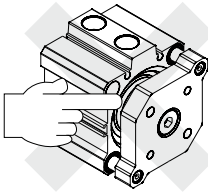

#### ⚠ Caution

1. Do not scratch or dent the sliding parts of the piston rod and guide rods.

Damage to seals may cause air leakage or faulty operation.

2. Mounting of work piece

When screwing a bolt onto the threaded portion of the plate surface, be certain that the guide rods are fully extended to the end.

Also, be careful that the tightening torque is not applied to the guide rods.

3. Make sure that the cylinder mounting surface has a flatness of 0.02 mm or less.

When mounting the cylinder body or workpieces on the plate, improper flatness of the mounting surface may cause malfunctions.

When the flatness of a workpiece is not sufficient, attaching a shim such as a flat washer, etc., at the place of a mounting bolt between the workpiece and the plate may reduce the affect on the operation.

### Others

#### ⚠ Caution

1. This product should not be used as a stopper.
2. Do not disassemble and modify the product.
3. For example, in a pressing application, the cylinder thrust is directly applied to the plate, therefore, make sure that the pressing force is applied to the plate directly on the extended axial line of a rod. (Below figures.)

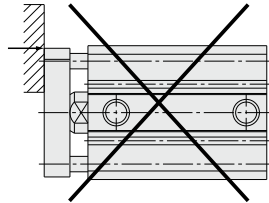
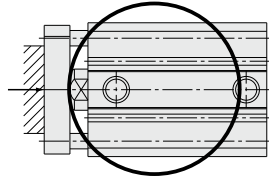

CJU

CU

CQS

JCQ

CQ2

RQ

**CQM**

CQU

MU

D-

-X

Technical  
Data