

Hygienic Design Cylinder

HY□ Series

A water resistant cylinder configured for easy cleaning

CJ5
CG5
HY□
Water
Resistant







HYB Series

ISO (15552) standard type
HYC Series

Basic type
HYQ Series

With guide
HYG Series

Series	Bore size							External seal material	Body material	Optional parts*	Mounting brackets*	Page	
	20	25	32	40	50	63	80						100
HYB 	●	●	●	●	●	●	●	●	NBR, FKM	Aluminum	Plug bolt External cover (Rod end / Head end) Plug bolt	Foot Flange (ø32 to ø100)	1084
HYQ 	●	●	●	●	●	●	●	●				Foot Flange Single clevis Double clevis (ø32 to ø63)	1088
HYC 	●	●	●	●	●	●	●	●				Foot Flange Single clevis Double clevis (ø32 to ø63)	1097
HYG 	●	●	●	●	●	●	●	●				Foot Flange Single clevis Double clevis (ø32 to ø63)	1103

* Optional parts and mounting brackets must be ordered separately. Refer to pages 1115 to 1119.



D-□
-X□
Technical
Data

A water resistant cylinder

Flat, grooveless configuration

Eliminates the auto switch groove and the holes for cushion needle holes, etc.

Current

Cushion needle



Cushion needle

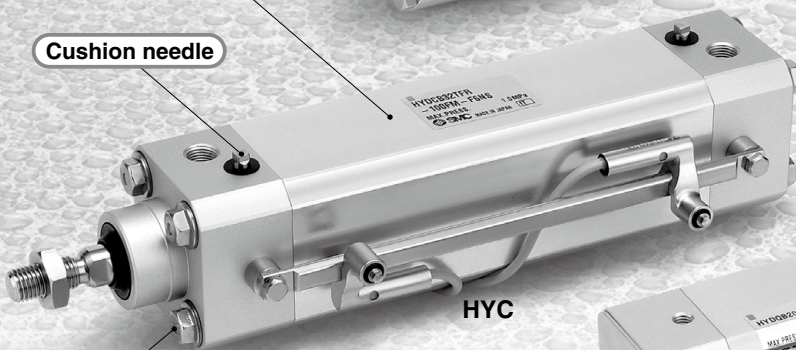

Plug bolt
(Option)

Scraper

Plug bolt
(Option)

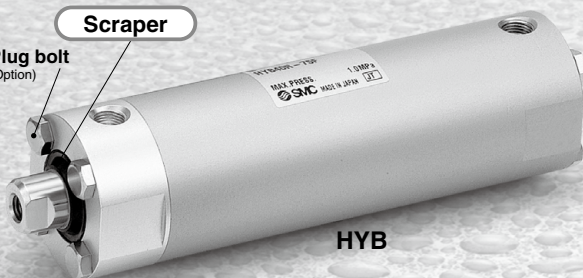

HYB

HYC

External cover
(Option)

HYQ



Five times increase in service life compared to current model (SMC ratio)

Water-proof examination result (Reference data)

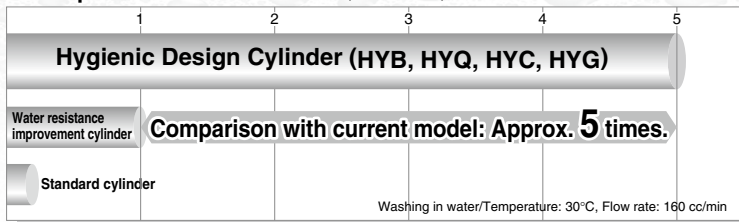

Grease for food (NSF-H1 certified) is available.

External seal material: Choice of NBR or FKM

Mounting section: Conforms to ISO/VDMA standard. (HYC series)

Not applicable for use in a "food zone". For details, refer to Specific Product Precautions (Page 1120).

configured for easy cleaning

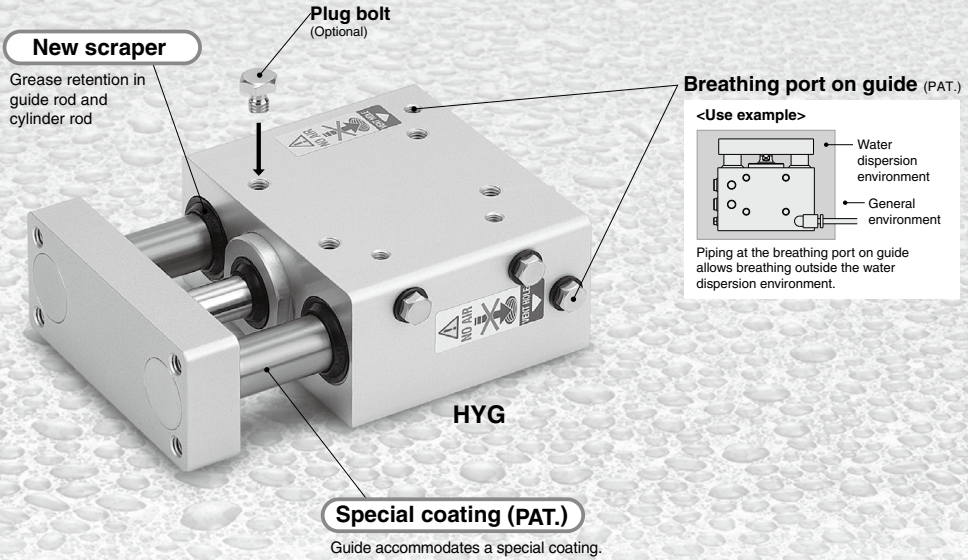

CJ5
CG5
HY
Water Resistant

●Piping●

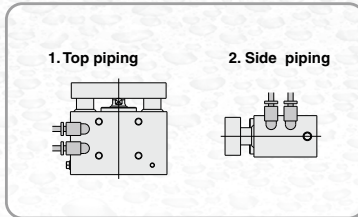

●Mounting●

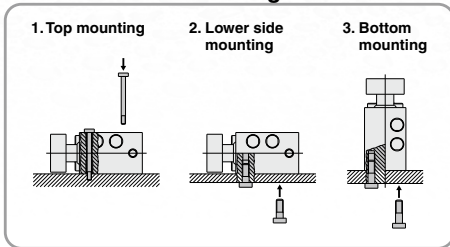

●Plug bolt●

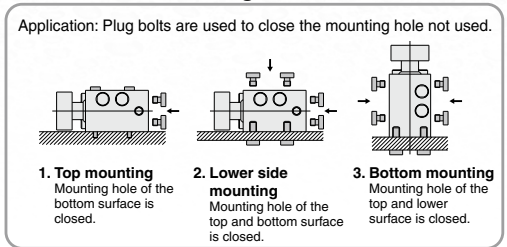

D-□
-X□
Technical Data

Hygienic Design Cylinder Round Type

HYB Series

ø20, ø25, ø32, ø40, ø50, ø63, ø80, ø100

How to Order

HYB 20 [] R - 50 F

With auto switch **HYDB 20 [] R - 50 F - H7BAL []**

With auto switch (Built-in magnet)

Bore size

20	20 mm
25	25 mm
32	32 mm
40	40 mm
50	50 mm
63	63 mm
80	80 mm
100	100 mm

Port thread type

Nil	M thread	ø20, ø25
	Rc	
TN	NPT	ø32 to ø100
TF	G	

Sealant material

R	NBR
H	External FKM ^(Note)

(Note) External seal material:
Rod scraper, tube gasket, and rod seal are made from FKM.

Number of auto switches

Nil	2 pcs.
S	1 pc.
n	"n" pcs.

Auto switch

Nil	Without auto switch (Built-in magnet)
-----	---------------------------------------

Refer to table below for selection of applicable auto switch.

Grease

Nil	Standard grease (for non-food)
F	Grease for food

(Note) Select grease for food for use in a water dispersion environment or when washing a product with water.
(Water resistance is insufficient with standard grease.)

Cylinder stroke

Refer to page 1085 for the standard stroke.

< Mounting bracket > Foot and flange (Rod end)

< Option parts > Plug bolt

Please place an order for above mentioned parts separately, please refer to pages 1115 to 1119 for details.

Applicable Auto Switches/Refer to pages 1575 to 1701 for detailed auto switch specifications.

Type	Special function	Electrical entry	Indicator light	Wiring (Output)	Load voltage		Auto switch model		Lead wire length (m)*		Pre-wired connector	Applicable load
					DC	AC	ø20 to ø63	ø80, ø100	3 (L)	5 (Z)		
Solid state auto switch	Water resistance improvement product (2-color display)	Grommet	Yes	2-wire	24 V	12 V	H7BA	G5BA	●	○	○	Relay, PLC

* Lead wire length symbols
3 m..... L (Example) H7BAL
5 m..... Z (Example) H7BAZ

* Auto switches marked with a "○" symbol are produced upon receipt of orders.

• Refer to pages 1648 and 1649 for detailed specifications about the auto switch with pre-wired connector.



Symbol

Rubber bumper

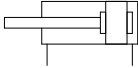

Specifications

Bore size (mm)	20	25	32	40	50	63	80	100
Action	Double acting, Single rod							
Fluid	Air							
Minimum operating pressure	0.2 MPa		0.15 MPa			0.07 MPa		
Maximum operating pressure	1.0 MPa							
Proof pressure	1.5 MPa							
Ambient and operating fluid temperature	Without auto switch 0°C to 70°C							
	With auto switch 0°C to 60°C							
Lubrication	Not required							
Piston speed	50 to 500 mm/s (With pressure at 1.0 MPa) ^{Note)}							
Cushion	Rubber bumper							
Stroke length tolerance	+1.4 0 mm							
Piston rod material	Stainless steel 304 / Hard chrome plated							

CJ5
CG5

HY□

Water
Resistant

Note) Use a cylinder below the allowable kinetic energy. Refer to page 1086 for the allowable kinetic energy.

Standard Stroke

Bore size (mm)	Standard stroke (mm)
20	25, 50, 75, 100, 125, 150, 200
25 to 100	25, 50, 75, 100, 125, 150, 200, 250, 300

* Intermediate strokes of 1 mm each can be produced. (The spacer is not used.)

Weight

Without auto switch

Unit: kg

Bore size (mm)	Stroke (mm)									
	25	50	75	100	125	150	175	200	250	300
20	0.15	0.17	0.18	0.20	0.22	0.24	0.26	0.27	—	—
25	0.20	0.22	0.24	0.27	0.29	0.31	0.34	0.36	0.40	0.45
32	0.26	0.29	0.32	0.35	0.38	0.41	0.44	0.47	0.53	0.59
40	0.50	0.55	0.59	0.64	0.68	0.73	0.78	0.82	0.91	1.01
50	0.88	0.95	1.02	1.09	1.15	1.22	1.29	1.35	1.49	1.62
63	1.21	1.29	1.38	1.47	1.55	1.64	1.72	1.81	1.98	2.15
80	2.01	2.13	2.24	2.35	2.47	2.58	2.69	2.81	3.03	3.26
100	3.52	3.68	3.84	3.99	4.15	4.31	4.47	4.63	4.95	5.27

With auto switch (Built-in magnet)

Unit: kg

Bore size (mm)	Stroke (mm)									
	25	50	75	100	125	150	175	200	250	300
20	0.15	0.17	0.19	0.21	0.22	0.24	0.26	0.28	—	—
25	0.20	0.22	0.25	0.27	0.29	0.32	0.34	0.36	0.41	0.46
32	0.28	0.31	0.33	0.36	0.39	0.42	0.45	0.48	0.54	0.60
40	0.51	0.56	0.61	0.65	0.70	0.74	0.79	0.83	0.93	1.02
50	0.90	0.97	1.03	1.10	1.17	1.23	1.30	1.37	1.50	1.64
63	1.23	1.32	1.40	1.49	1.58	1.66	1.75	1.83	2.00	2.17
80	2.04	2.16	2.27	2.38	2.50	2.61	2.72	2.84	3.06	3.29
100	3.55	3.71	3.87	4.03	4.19	4.35	4.51	4.67	4.98	5.30

Theoretical Output

Unit: N

Bore size (mm)	Operating direction	Operating pressure (MPa)		
		0.3	0.5	0.7
20	OUT	94.2	157	220
	IN	79.2	132	185
25	OUT	147	246	344
	IN	124	206	288
32	OUT	241	402	563
	IN	207	346	484
40	OUT	378	630	882
	IN	318	530	742
50	OUT	588	980	1370
	IN	495	825	1160
63	OUT	936	1560	2180
	IN	840	1400	1960
80	OUT	1510	2520	3520
	IN	1360	2270	3180
100	OUT	2360	3930	5500
	IN	2150	3580	5010

D-□

-X□

Technical
Data

HYB Series

Allowable Load at Rod End

ø20, ø25, ø32, ø40

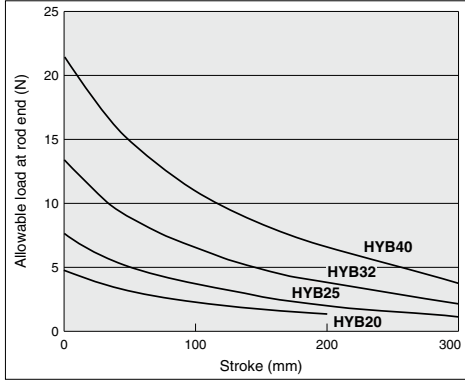

ø50, ø63, ø80, ø100

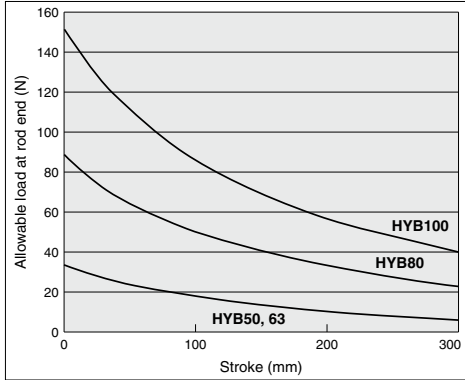

• A case where the center of gravity of the load rests 50 mm from the rod end.

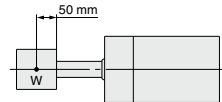

Allowable Kinetic Energy

(Supply pressure: at P = 0.5 MPa)

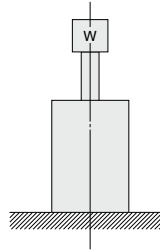
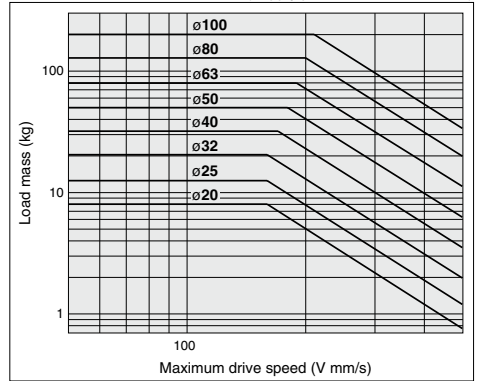

Dimensions

HY□B20 to 100

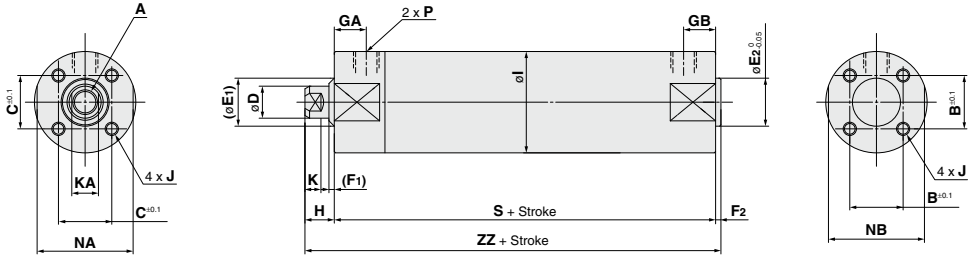

CJ5
CG5

HY□

Water
Resistant

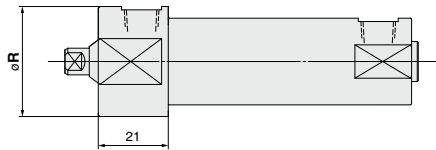

ø20, 25

(mm)

Bore size (mm)	A	B	C	D	E1	E2	F1	F2	GA		GB	H	I	J
									Port: M5, Rc, NPT	Port: G				
20	M4 x 0.7 depth 8	14	18.5	8	18	12	3	2	13		10	10	26	M4 x 0.7 depth 7
25	M5 x 0.8 depth 10	16.5	18.5	10	18	14	3	2	13		10	10	31	M5 x 0.8 depth 7.5
32	M6 x 1.0 depth 12	20	20	12	20	18	3	2	12	11	10	10	38	M5 x 0.8 depth 8
40	M8 x 1.25 depth 13	26	26	16	26	25	3	2	13	10	10	15	47	M6 x 1.0 depth 12
50	M10 x 1.5 depth 15	32	32	20	32	30	3	2	14	14	12	15	58	M8 x 1.25 depth 16
63	M10 x 1.5 depth 15	38	38	20	32	32	3	2	14	12	12	15	72	M10 x 1.5 depth 16
80	M16 x 2.0 depth 21	50	50	25	37	40	3	3	20	17	16	20	89	M10 x 1.5 depth 22
100	M20 x 2.5 depth 27	60	60	30	42	50	3	3	20	17	16	20	110	M12 x 1.75 depth 22

Bore size (mm)	K	KA	NA	NB	P			R	S	ZZ
					Nii	TF	TN			
20	5	6	30	24	M5 x 0.8	—	—	33	69	81
25	5	8	30	29	M5 x 0.8	—	—	33	69	81
32	6	10	35.5	35.5	Rc 1/8	G 1/8	NPT 1/8	—	71	83
40	6.5	13	44	44	Rc 1/8	G 1/8	NPT 1/8	—	78	95
50	8	16	55	55	Rc 1/4	G 1/4	NPT 1/4	—	90	107
63	8	16	69	69	Rc 1/4	G 1/4	NPT 1/4	—	90	107
80	9.5	22	80	80	Rc 3/8	G 3/8	NPT 3/8	—	108	131
100	11.5	27	100	100	Rc 1/2	G 1/2	NPT 1/2	—	108	131

D-□

-X□

Technical
Data

Hygienic Design Cylinder Basic Type

HYQ Series

ø20, ø25, ø32, ø40, ø50, ø63

How to Order

HYQB 20 □ R - 50 F M

With auto switch **HYDQB 20 □ R - 50 F M - F6B □**

With auto switch (Built-in magnet and switch rail)

Bore size

20	20 mm
25	25 mm
32	32 mm
40	40 mm
50	50 mm
63	63 mm

Port thread type

Nil	M thread	ø20, ø25
	Rc	
TN	NPT	ø32 to ø63
TF	G	

Sealant material

R	NBR
H	External FKM <small>Note)</small>

Note) External seal material: Rod scraper, tube gasket, and rod seal are made from FKM.

Number of auto switches

Nil	2 pcs.
S	1 pc.
n	"n" pcs.

Auto switch

Nil	Without auto switch
-----	---------------------

Refer to table below for selection of applicable auto switch.

Type of rod end

Nil	Female thread
M	Male thread

Grease

Nil	Standard grease (for non-food)
F	Grease for food

Note) Select grease for food for use in a water dispersion environment or when washing a product with water. (Water resistance is insufficient with standard grease.)

Cylinder stroke

Refer to page 1089 for the standard stroke.

< Mounting bracket > Foot, flange, single clevis, double clevis, and clevis pin
< Option parts > External cover
Please place an order for above mentioned parts separately, please refer to pages 1115 to 1119 for details.

Applicable Auto Switches/Refer to pages 1575 to 1701 for detailed auto switch specifications.

Type	Electrical entry	Indicator light	Wiring (Output)	Load voltage		Auto switch model	Lead wire length (m) [*]			Pre-wired connector	Applicable load	
				DC			0.5 (Nil)	3 (L)	5 (Z)			
Solid state auto switch	Grommet	Yes	3-wire (NPN)	24 V	5 V	F6N	●	●	○	○	IC circuit	Relay, PLC
			3-wire (PNP)		12 V	F6P	●	●	○			
			2-wire		12 V	F6B	●	●	○			

* Lead wire length symbols 0.5 m..... Nil (Example) F6B
3 m..... L (Example) F6BL
5 m..... Z (Example) F6BZ

* Auto switches marked with a "○" symbol are produced upon receipt of orders.

• Refer to pages 1648 and 1649 for detailed specifications about the auto switch with pre-wired connector.

* Auto switch is shipped not assembled with the cylinder.

Note) The D-F6□ auto switch has an exterior configuration that reduces residual liquid; it does not feature improved water resistance.

Specifications



Bore size (mm)	20	25	32	40	50	63
Action	Double acting, Single rod					
Fluid	Air					
Minimum operating pressure	0.2 MPa			0.15 MPa		
Maximum operating pressure	1.0 MPa					
Proof pressure	1.5 MPa					
Ambient and operating fluid temperature	Without auto switch 0 to 70°C					
	With auto switch 0 to 60°C					
Lubrication	Not required					
Piston speed	50 to 500 mm/s (With pressure at 1.0 MPa) ^{Note)}					
Cushion	Rubber bumper					
Stroke length tolerance	$^{+1.4}_{0}$ mm					
Piston rod material	Stainless steel 304 / Hard chrome plated					

Note) Use a cylinder below the allowable kinetic energy. Refer to page 1090 for the allowable kinetic energy.

CJ5
CG5
HY□
Water
Resistant

Symbol

Rubber bumper

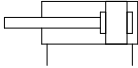

Standard Stroke

Bore size (mm)	Standard stroke (mm)
20	5, 10, 15, 20, 25, 30, 35, 40, 45, 50
25	5, 10, 15, 20, 25, 30, 35, 40, 45, 50
32	5, 10, 15, 20, 25, 30, 35, 40, 45, 50, 75, 100
40	5, 10, 15, 20, 25, 30, 35, 40, 45, 50, 75, 100
50	10, 15, 20, 25, 30, 35, 40, 45, 50, 75, 100
63	10, 15, 20, 25, 30, 35, 40, 45, 50, 75, 100

* Intermediate strokes of 1 mm each can be produced. (The spacer is not used.)

Weight

Without auto switch / Female thread type

Unit: kg

Bore size (mm)	Stroke (mm)											
	5	10	15	20	25	30	35	40	45	50	75	100
20	0.16	0.17	0.18	0.19	0.20	0.22	0.23	0.24	0.25	0.26	—	—
25	0.24	0.26	0.27	0.29	0.30	0.32	0.34	0.35	0.37	0.39	—	—
32	0.43	0.45	0.48	0.50	0.52	0.55	0.57	0.60	0.62	0.65	0.77	0.89
40	0.63	0.66	0.69	0.72	0.76	0.79	0.82	0.85	0.89	0.92	1.08	1.25
50	—	1.11	1.20	1.30	1.39	1.48	1.57	1.67	1.76	1.85	2.32	2.78
63	—	1.59	1.70	1.82	1.94	2.06	2.18	2.30	2.41	2.53	3.12	3.72

Without auto switch / Male thread type

Unit: kg

Bore size (mm)	Stroke (mm)											
	5	10	15	20	25	30	35	40	45	50	75	100
20	0.16	0.18	0.19	0.20	0.21	0.22	0.23	0.24	0.25	0.27	—	—
25	0.25	0.27	0.28	0.30	0.32	0.33	0.35	0.36	0.38	0.40	—	—
32	0.45	0.48	0.50	0.52	0.55	0.57	0.60	0.62	0.65	0.67	0.79	0.91
40	0.66	0.70	0.73	0.76	0.79	0.83	0.86	0.89	0.92	0.96	1.12	1.28
50	—	1.28	1.37	1.46	1.55	1.65	1.74	1.83	1.93	2.02	2.48	2.95
63	—	1.68	1.80	1.92	2.04	2.15	2.27	2.39	2.51	2.63	3.22	3.81

With auto switch (Built-in magnet and switch rail) / Female thread type

Unit: kg

Bore size (mm)	Stroke (mm)											
	5	10	15	20	25	30	35	40	45	50	75	100
20	0.21	0.22	0.23	0.24	0.26	0.27	0.28	0.29	0.31	0.32	—	—
25	0.30	0.32	0.33	0.35	0.37	0.39	0.40	0.42	0.44	0.46	—	—
32	0.54	0.56	0.59	0.61	0.64	0.66	0.69	0.72	0.74	0.77	0.90	1.02
40	0.77	0.81	0.84	0.87	0.90	0.94	0.97	1.00	1.03	1.07	1.23	1.39
50	—	1.30	1.40	1.49	1.59	1.68	1.78	1.87	1.97	2.06	2.53	3.01
63	—	1.86	1.98	2.10	2.22	2.34	2.46	2.58	2.70	2.82	3.42	4.02

With auto switch (Built-in magnet and switch rail) / Male thread type

Unit: kg

Bore size (mm)	Stroke (mm)											
	5	10	15	20	25	30	35	40	45	50	75	100
20	0.21	0.22	0.24	0.25	0.26	0.27	0.29	0.30	0.31	0.32	—	—
25	0.31	0.33	0.35	0.36	0.38	0.40	0.42	0.43	0.45	0.47	—	—
32	0.56	0.59	0.61	0.64	0.66	0.69	0.71	0.74	0.77	0.79	0.92	1.05
40	0.81	0.84	0.88	0.91	0.94	0.97	1.01	1.04	1.07	1.10	1.27	1.43
50	—	1.47	1.57	1.66	1.76	1.85	1.94	2.04	2.13	2.23	2.70	3.17
63	—	1.96	2.08	2.20	2.31	2.43	2.55	2.67	2.79	2.91	3.51	4.11

Theoretical Output

Bore size (mm)	Operating direction	Operating pressure (MPa)		Unit: N
		0.3	0.5	
20	IN	79.2	132	185
	OUT	94.2	157	220
25	IN	124	206	288
	OUT	147	246	344
32	IN	207	346	484
	OUT	241	402	563
40	IN	318	530	742
	OUT	378	630	882
50	IN	495	825	1160
	OUT	588	980	1370
63	IN	840	1400	1960
	OUT	936	1560	2180

D-□
-X□
Technical
Data

Allowable Load at Rod End

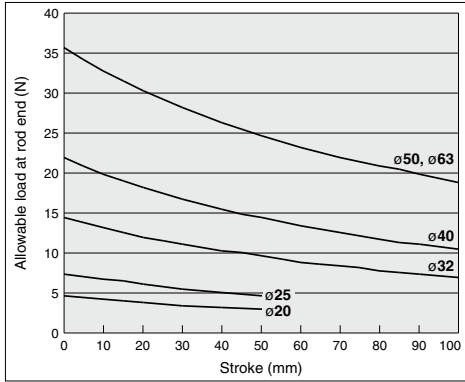

• The above graph shows a case that the center of gravity of the load rests 50 mm from the rod end.

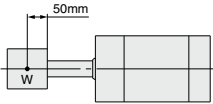

Allowable Kinetic Energy

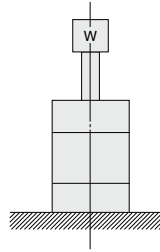
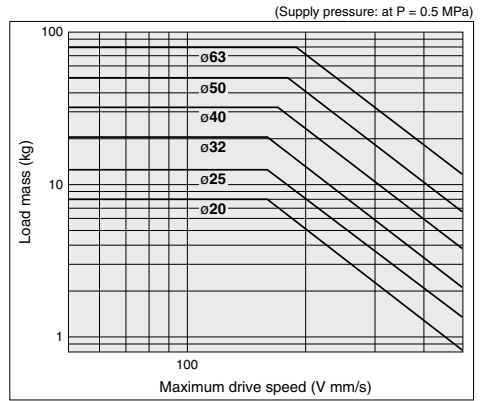

Construction: $\varnothing 20, \varnothing 25$

Basic type

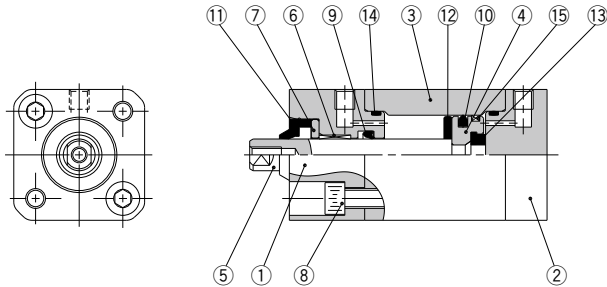

CJ5
CG5
HY
Water
Resistant

Rod end male thread

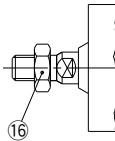

Built-in magnet

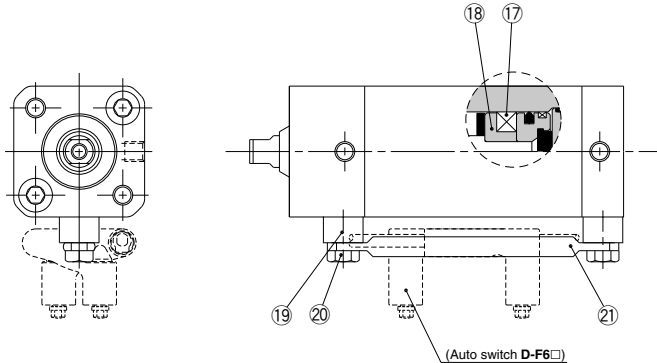

Component Parts

No.	Description	Material	Qty.	Note
1	Rod cover	Aluminum alloy	1	Anodic oxide film
2	Head cover	Aluminum alloy	1	Anodic oxide film
3	Cylinder tube	Aluminum alloy	1	Anodic oxide film
4	Piston	Aluminum alloy	1	
5	Piston rod	Stainless steel	1	Hard chromium plated
6	Bushing	Resin	1	
7	Bushing retainer	Aluminum alloy	1	Chromated
8	Hexagon socket head cap screw	Stainless steel	4	
9	Rod seal	NBR	1	(FKM can be selected.)
10	Piston seal	NBR	1	
11	Rod scraper	NBR	1	(FKM can be selected.)
12	Bumper A	Resin	1	
13	Bumper B	Resin	1	
14	Tube gasket	NBR	2	(FKM can be selected.)
15	Wearing	Resin	1	
16	Rod end nut	Stainless steel	1	(Only rod end male thread)

No.	Description	Material	Qty.	Note
17	Magnet	—	1	(Only built-in magnet)
18	Magnet holder	Aluminum alloy	1	(Only built-in magnet) Chromated
19	Switch rail base	Stainless steel	2	(Only built-in magnet)
20	Hexagon bolt	Stainless steel	2	(Only built-in magnet)
21	Switch rail	Stainless steel	1	(Only built-in magnet)

Replacement Parts: Seal Kit

Bore size	Part no.	Set contents
20	HYQB20□-PS	Set of nos. above ⑨, ⑩ and ⑭
25	HYQB25□-PS	

Place the seal material symbol in □.

Symbol	Material
R	NBR
H	External FKM*

- * External seal: Rod seal and the tube gasket are made from FKM.
- * Seal kit includes ⑨, ⑩ and ⑭. Order the seal kit based on each bore size.
- * Since the seal kit does not include a grease pack, order it separately.
- Grease for food part no.: GR-H-010 (10 g)
- Standard grease part no.: GR-S-010 (10 g)

D □
-X □
Technical
Data

HYQ Series

Construction: $\phi 32$ to $\phi 63$

Basic type

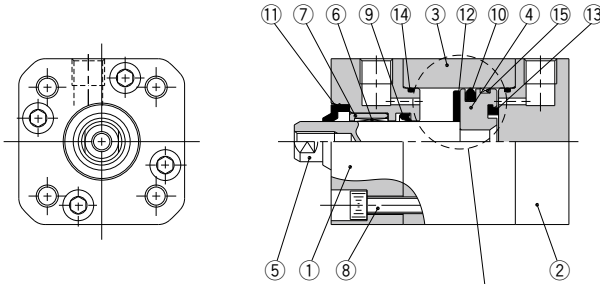

Rod end male thread

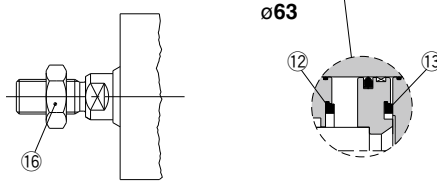

Built-in magnet

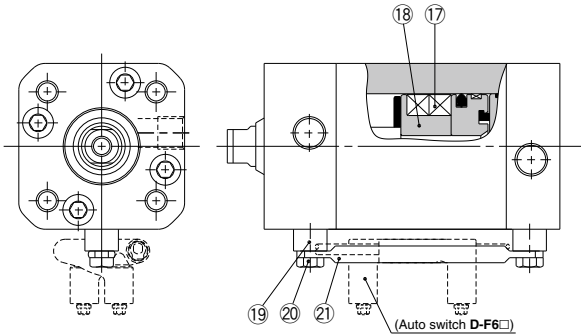

Component Parts

No.	Description	Material	Qty.	Note
1	Rod cover	Aluminum alloy	1	Anodic oxide film
2	Head cover	Aluminum alloy	1	Anodic oxide film
3	Cylinder tube	Aluminum alloy	1	Anodic oxide film
4	Piston	Aluminum alloy	1	
5	Piston rod	Stainless steel	1	Hard chromium plated
6	Bushing	Resin	1	
7	Bushing retainer	Aluminum alloy	1	Chromated
8	Hexagon socket head cap screw	Stainless steel	8	
9	Rod seal	NBR	1	(FKM can be selected.)
10	Piston seal	NBR	1	
11	Rod scraper	NBR	1	(FKM can be selected.)
12	Bumper A	Resin	1	
13	Bumper B	Resin	1	(Only $\phi 63$ is common to the bumper A.)
14	Tube gasket	NBR	2	(FKM can be selected.)
15	Wearing	Resin	1	
16	Rod end nut	Stainless steel	1	(Only rod end male thread)
17	Magnet	—	2	(Only built-in magnet)

No.	Description	Material	Qty.	Note
18	Magnet holder	Aluminum alloy	1	(Only built-in magnet) Chromated
19	Switch rail base	Stainless steel	2	(Only built-in magnet)
20	Hexagon bolt	Stainless steel	2	(Only built-in magnet)
21	Switch rail	Stainless steel	1	(Only built-in magnet)

Replacement Parts: Seal Kit

Bore size	Part no.	Set contents
32	HYQB32□-PS	Set of nos. above 9, 10 and 14
40	HYQB40□-PS	
50	HYQB50□-PS	
63	HYQB63□-PS	

Place the seal material symbol in □.

Symbol	Material
R	NBR
H	External FKM®

- * External seal: Rod seal and the tube gasket are made from FKM.
- * Seal kit includes 9, 10 and 14. Order the seal kit based on each bore size.
- * Since the seal kit does not include a grease pack, order it separately.

Grease for food part no.: GR-H-010 (10 g)
Standard grease part no.: GR-S-010 (10 g)

Dimensions

Without auto switch: **HYQB20, 25**

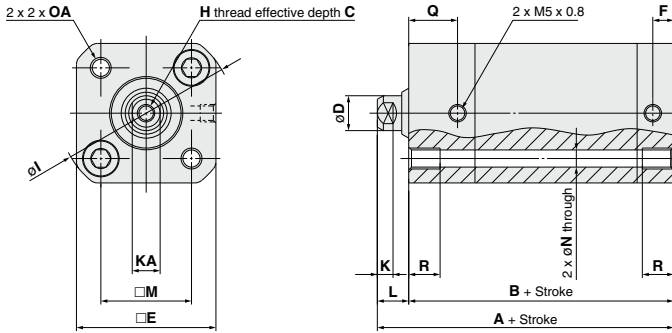

CJ5
CG5

HY□

Water
Resistant

Rod end male thread

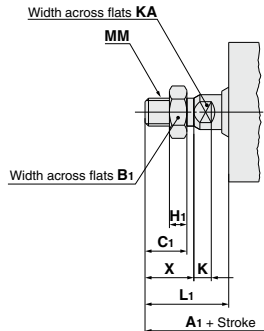

Rod End Male Thread

(mm)

Bore size	A1	B1	C1	MM	H1	K	KA	L1	X
20	72	10	10	M6 x 1.0	3.6	5	6	22	12
25	75	13	12	M8 x 1.25	5	5	8	24	14

Bore size	Stroke range	A	B	C	D	E	F	H	I	K	KA	L	M	N	OA	Q	R
20	5 to 50	60	50	8	8	33	6	M4 x 0.7	42	5	6	10	22	4.4	M5 x 0.8	14	10
25	5 to 50	61	51	10	10	40	6	M5 x 0.8	50	5	8	10	26	5.4	M6 x 1.0	14	10

Note 1) Refer to pages 1115 to 1119 for details about the rod end nut, mounting bracket and accessory bracket.
Note 2) When the unit is installed, ensure that dirt does not collect in the rod end (threaded portion).

D-□

-X□

Technical
Data

HYQ Series

Dimensions

With auto switch: HYDQB20, 25

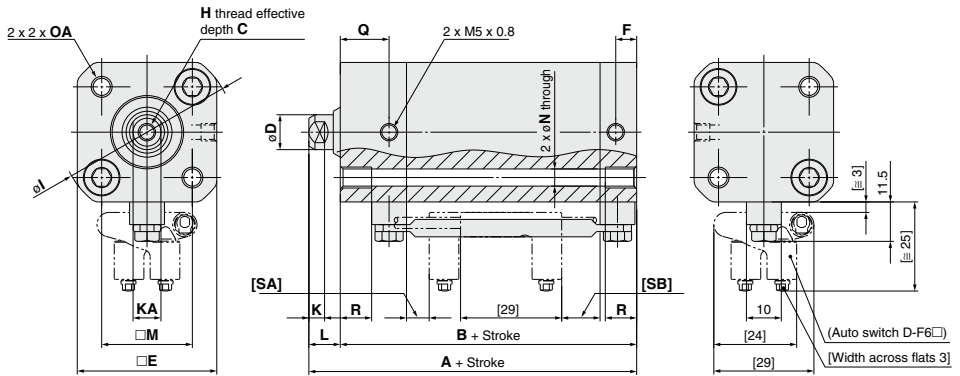

Rod end male thread

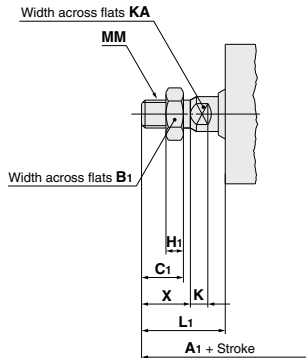

Rod End Male Thread

Bore size	A1	B1	C1	MM	H1	K	KA	L1	X
20	82	10	10	M6 x 1.0	3.6	5	6	22	12
25	85	13	12	M8 x 1.25	5	5	8	24	14

Bore size	Stroke range	A	B	C	D	E	F	H	I	K	KA	L	M	N	OA	Q	R	SA	SB
20	5 to 50	70	60	8	8	33	6	M4 x 0.7	42	5	6	10	22	4.4	M5 x 0.8	14	10	6.5	10.5
25	5 to 50	71	61	10	10	40	6	M5 x 0.8	50	5	8	10	26	5.4	M6 x 1.0	14	10	6.5	11

Note 1) The [] value denotes dimensions with the auto switch D-F6□ mounted, which is dedicated to the Hygienic Design Cylinder.

Note 2) Refer to pages 1115 to 1119 for details about the rod end nut, mounting bracket and accessory bracket.

Note 3) When the unit is installed, ensure that dirt does not collect in the rod end (threaded portion).

Dimensions

Without auto switch: HYQB32 to 63

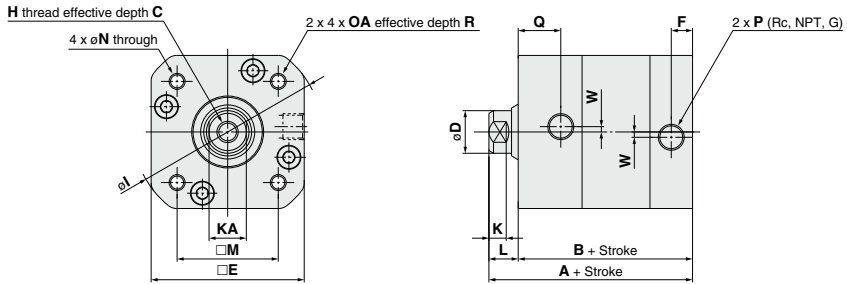

CJ5
CG5

HY□

Water
Resistant

Rod end male thread

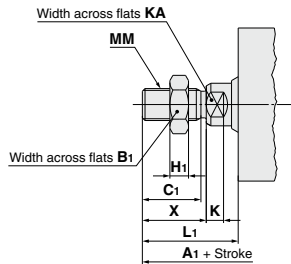

Rod End Male Thread

(mm)

Bore size	A1	B1	C1	MM	H1	K	KA	L1	X
32	94	17	20	M10 x 1.25	6	6	10	33	22
40	101.5	19	22	M12 x 1.25	7	6.5	13	36	24
50	122.5	24	29.5	M16 x 1.5	10	8	16	46	32
63	123	24	29.5	M16 x 1.5	10	8	16	46	32

(mm)

Bore size	Stroke range	A	B	C	D	E	F	H	I	K	KA	L	M	N	OA	P	Q	R	W
32	5 to 100	72	61	12	12	49.5	8.5	M6 x 1.0	62	6	10	11	32.5	5.4	M6 x 1.0	1/8	13.5	16	4
40	5 to 100	77.5	65.5	13	16	57.5	8.5	M8 x 1.25	71	6.5	13	12	38	5.4	M6 x 1.0	1/8	16	16	2
50	10 to 100	90.5	76.5	15	20	69	10.5	M10 x 1.5	88	8	16	14	46.5	6.8	M8 x 1.25	1/4	20	16	4
63	10 to 100	91	77	18	20	84	10.5	M12 x 1.75	102	8	16	14	56.5	6.8	M8 x 1.25	1/4	21	16	4

Note 1) Refer to pages 1115 to 1119 for details about the rod end nut, mounting bracket and accessory bracket.

Note 2) When the unit is installed, ensure that dirt does not collect in the rod end (threaded portion).

D-□

-X□

Technical
Data

Dimensions

With auto switch: HYDQB32 to 63

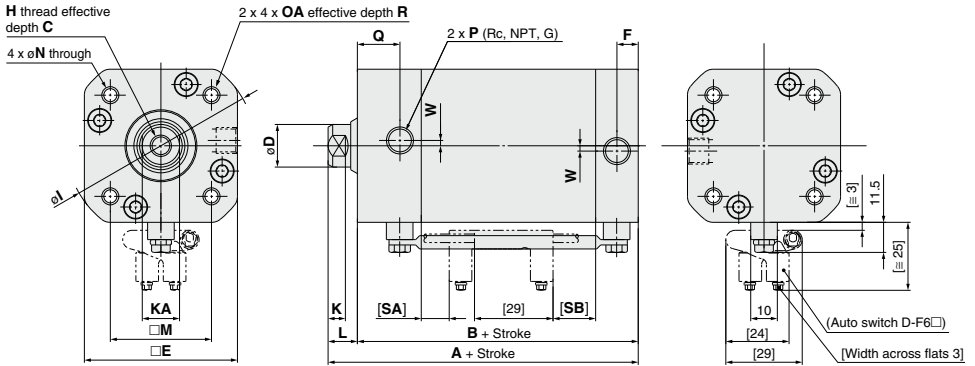

Rod end male thread

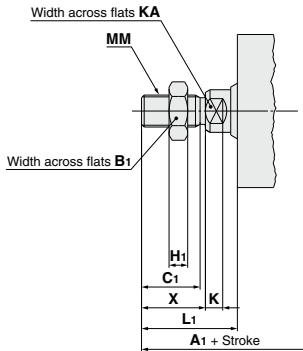

Rod End Male Thread

Bore size	A ₁	B ₁	C ₁	MM	H ₁	K	KA	L ₁	X
32	109	17	20	M10 x 1.25	6	6	10	33	22
40	116.5	19	22	M12 x 1.25	7	6.5	13	36	24
50	137.5	24	29.5	M16 x 1.5	10	8	16	46	32
63	138	24	29.5	M16 x 1.5	10	8	16	46	32

Bore size	Stroke range	A	B	C	D	E	F	H	I	K	KA	L	M	N	OA	P	Q	R	SA	SB	W
32	5 to 100	87	76	12	12	49.5	8.5	M6 x 1.0	62	6	10	11	32.5	5.4	M6 x 1.0	1/8	13.5	16	8.5	16	4
40	5 to 100	92.5	80.5	13	16	57.5	8.5	M8 x 1.25	71	6.5	13	12	38	5.4	M6 x 1.0	1/8	16	16	10.5	16	2
50	10 to 100	105.5	91.5	15	20	69	10.5	M10 x 1.5	88	8	16	14	46.5	6.8	M8 x 1.25	1/4	20	16	10.5	17	4
63	10 to 100	106	92	18	20	84	10.5	M12 x 1.75	102	8	16	14	56.5	6.8	M8 x 1.25	1/4	21	16	9	18	4

Note 1) The [] value denotes dimensions with the auto switch D-F6□ mounted, which is dedicated to the Hygienic Design Cylinder.

Note 2) Refer to pages 1115 to 1119 for details about the rod end nut, mounting bracket and accessory bracket.

Note 3) When the unit is installed, ensure that dirt does not collect in the rod end (threaded portion).

Hygienic Design Cylinder ISO Standard Type

HYC Series

ø32, ø40, ø50, ø63

CJ5
CG5

HY□

Water
Resistant

How to Order

HYCB 32 □ R - 500 F

With auto switch **HYDCB 32 □ R - 500 F - F6B □**

With auto switch (Built-in magnet and switch rail)

Bore size

32	32 mm
40	40 mm
50	50 mm
63	63 mm

Port thread type

Nil	Rc
TN	NPT
TF	G

Sealant material

R	NBR
H	External FKM <small>(Note)</small>

Note) External seal material: Rod scraper, tube gasket, rod seal and needle scraper are made from FKM.

Number of auto switches

Nil	2 pcs.
S	1 pc.
n	"n" pcs.

Auto switch

Nil	Without auto switch
-----	---------------------

Refer to table below for selection of applicable auto switch.

Grease

Nil	Standard grease (for non-food)
F	Grease for food

Note) Select grease for food for use in a water dispersion environment or when washing a product with water. (Water resistance is insufficient with standard grease.)

Cylinder stroke

Refer to page 1098 for the standard stroke.

Built-in Magnet Cylinder Model

If a built-in magnet cylinder without an auto switch is required, there is no need to enter the symbol for the auto switch. (Example) HYDCB40R-300F

< Mounting bracket > Foot, flange, single clevis, double clevis, and clevis pin
< Option parts > Plug bolt

Please place an order for above mentioned parts separately, please refer to pages 1115 to 1119 for details.

Applicable Auto Switches/Refer to pages 1575 to 1701 for detailed auto switch specifications.

Type	Electrical entry	Indicator light	Wiring (Output)	Load voltage		Auto switch model	Lead wire length (m) [*]			Pre-wired connector	Applicable load	
				DC	AC		0.5 (Nil)	3 (L)	5 (Z)		IC circuit	Relay, PLC
Solid state auto switch	Grommet	Yes	3-wire (NPN)	24 V	5 V	F6N	●	●	○	○	IC circuit	Relay, PLC
			3-wire (PNP)		12 V	F6P	●	●	○			
			2-wire		12 V	F6B	●	●	○			

* Lead wire length symbols 0.5 m.....Nil (Example) F6B
3 m.....L (Example) F6BL
5 m.....Z (Example) F6BZ

* Auto switches marked with a "○" symbol are produced upon receipt of orders.

• Refer to pages 1648 and 1649 for detailed specifications about the auto switch with pre-wired connector.

* Auto switch is shipped not assembled with the cylinder.

Note) The D-F6□ auto switch has an exterior configuration that reduces residual liquid; it does not feature improved water resistance.

D-□

-X□

Technical
Data



Symbol

Air cushion

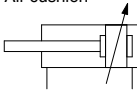

Specifications

Bore size (mm)	32	40	50	63
Action	Double acting, Single rod			
Fluid	Air			
Minimum operating pressure	0.15 MPa			
Maximum operating pressure	1.0 MPa			
Proof pressure	1.5 MPa			
Ambient and operating fluid temperature	Without auto switch 0°C to 70°C			
	With auto switch 0°C to 60°C			
Lubrication	Not required			
Piston speed	50 to 500 mm/s (With pressure at 1.0 MPa) ^{Note)}			
Cushion	Air cushion			
Stroke length tolerance	250 mm ^{+1.0} ₀ mm or less, 251 to 600 mm ^{+1.4} ₀ mm			
Piston rod material	Stainless steel 304 / Hard chrome plated			

Note) Use a cylinder below the allowable kinetic energy. Refer to page 1099 for the allowable kinetic energy.

Standard Stroke

Bore size (mm)	Standard stroke (mm)
32	25, 50, 75, 100, 125, 150, 200, 250, 300, 400, 500
40	25, 50, 75, 100, 125, 150, 200, 250, 300, 400, 500
50	25, 50, 75, 100, 125, 150, 200, 250, 300, 400, 500, 600
63	25, 50, 75, 100, 125, 150, 200, 250, 300, 400, 500, 600

* Intermediate strokes of 1 mm each can be produced. (The spacer is not used.)

Weight

Without auto switch

Unit: kg

Bore size (mm)	Stroke (mm)											
	25	50	75	100	125	150	200	250	300	400	500	600
32	0.89	1.02	1.14	1.26	1.38	1.50	1.75	1.99	2.23	2.72	3.21	—
40	1.30	1.46	1.62	1.79	1.95	2.11	2.44	2.77	3.09	3.75	4.40	—
50	2.03	2.26	2.50	2.73	2.96	3.20	3.66	4.13	4.59	5.52	6.45	7.38
63	2.95	3.25	3.54	3.84	4.13	4.43	5.02	5.61	6.21	7.39	8.57	9.76

With auto switch (Built-in magnet and switch rail)

Unit: kg

Bore size (mm)	Stroke (mm)											
	25	50	75	100	125	150	200	250	300	400	500	600
32	0.93	1.06	1.19	1.32	1.44	1.57	1.83	2.09	2.34	2.86	3.37	—
40	1.34	1.51	1.68	1.85	2.02	2.19	2.53	2.87	3.21	3.89	4.57	—
50	2.07	2.31	2.55	2.79	3.03	3.27	3.75	4.23	4.71	5.66	6.62	7.58
63	3.00	3.30	3.60	3.91	4.21	4.51	5.12	5.72	6.33	7.54	8.75	9.96

Theoretical Output

Unit: N

Bore size (mm)	Operating direction	Operating pressure (MPa)		
		0.3	0.5	0.7
32	IN	207	346	484
	OUT	241	402	563
40	IN	318	530	742
	OUT	378	630	882
50	IN	495	825	1160
	OUT	588	980	1370
63	IN	840	1400	1960
	OUT	936	1560	2180

Allowable Load at Rod End

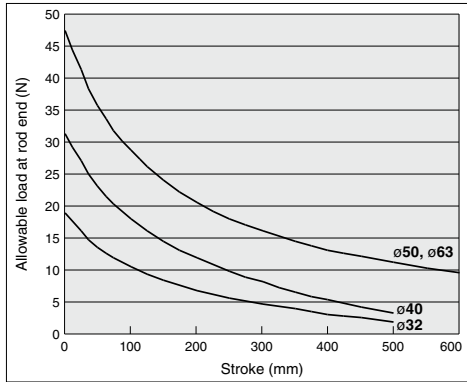

• A case where the center of gravity of the load rests 50 mm from the rod end.

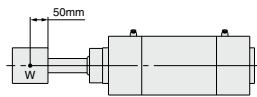

Allowable Kinetic Energy

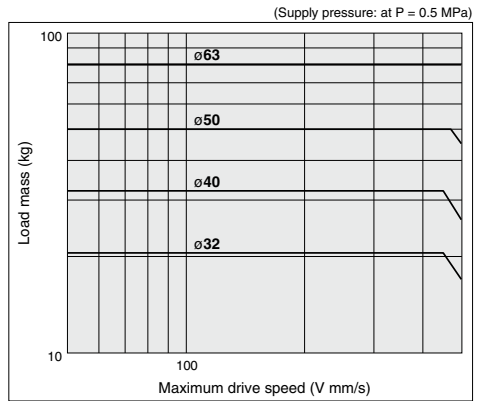

CJ5
CG5
HYC
Water Resistant

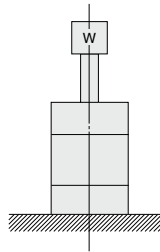

D-
-X
Technical Data

HYC Series

Construction

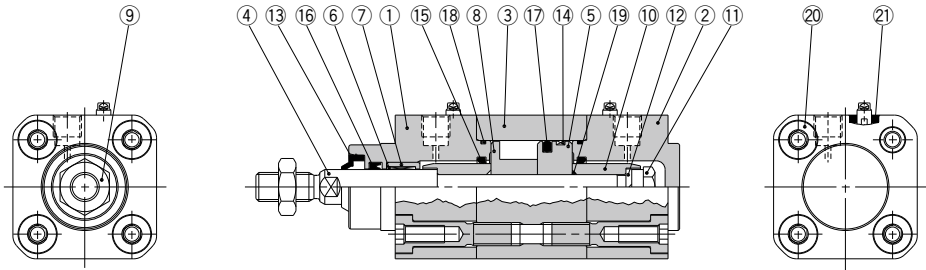

Built-in magnet

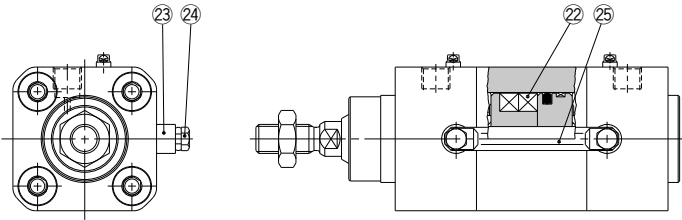

Component Parts

No.	Description	Material	Qty.	Note
1	Rod cover	Aluminum alloy	1	Anodic oxide film
2	Head cover	Aluminum alloy	1	Anodic oxide film
3	Cylinder tube	Aluminum alloy	1	Anodic oxide film
4	Piston rod	Stainless steel	1	Hard chromium plated
5	Piston	Aluminum alloy	1	Chromated
6	Bushing	Resin	1	
7	Bushing retainer	Aluminum alloy	1	Chromated
8	Magnet holder	Aluminum alloy	1	Chromated
9	Rod end nut	Stainless steel	1	
10	Cushion ring	Steel	2	Zinc chromated
11	Piston nut	Stainless steel	1	
12	Spring washer	Steel	1	
13	Rod scraper	NBR	1	(FKM can be selected.)
14	Wearing	Resin	1	
15	Cushion seal	Resin	2	
16	Rod seal	NBR	1	(FKM can be selected.)
17	Piston seal	NBR	1	
18	Cylinder tube gasket	NBR	2	(FKM can be selected.)
19	Piston gasket	NBR	1	
20	Tie-rod bolt	Stainless steel	8	
21	Needle scraper	NBR	2	(FKM can be selected.)

No.	Description	Material	Qty.	Note
22	Magnet	—	2	(Only built-in magnet)
23	Switch rail base	Stainless steel	2	(Only built-in magnet)
24	Hexagon bolt	Stainless steel	2	(Only built-in magnet)
25	Switch rail	Stainless steel	1	(Only built-in magnet)

Replacement Parts: Seal Kit

Bore Size	Part no.	Set contents
32	HYCB32□-PS	Set of nos. above (15, 16, 17, 18 and 21)
40	HYCB40□-PS	
50	HYCB50□-PS	
63	HYCB63□-PS	

Place the seal material symbol in □.

Symbol	Material
R	NBR
H	External FKM®

- * External seal: Rod seal, the tube gasket and needle scraper are made from FKM.
- * Seal kit includes (15, 16, 17, 18 and 21). Order the seal kit based on each bore size.
- * Since the seal kit does not include a grease pack, order it separately.

Grease for food part no.: GR-H-010 (10 g)
Standard grease part no.: GR-S-010 (10 g)

Construction

Without auto switch: HYCB32 to 63

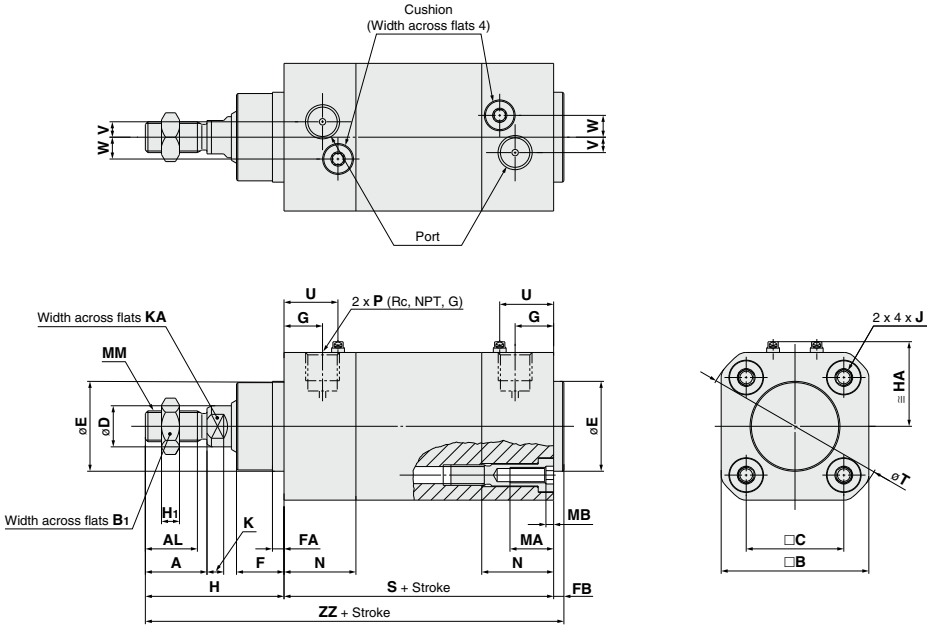

CJ5
CG5

HY□

Water
Resistant

		(mm)																											
Bore size	Stroke range	A	AL	B	B ₁	C	D	E ^{ø11}	F	FA	FB	G	H	H ₁	MA	MB	J	K	KA	MM	N	P	S	T	U	V	W	HA	ZZ
32	500 or less	22	18	50	17	32.5	12	30	16	5	4	14	48	6	16	3.2	M6 x 1	6	10	M10 x 1.25	28	1/8	94	62	21	6	6.5	30	146
40	500 or less	24	20	58	19	38	16	35	18.5	4.5	4	15	54	7	16	3.2	M6 x 1	6.5	13	M12 x 1.25	28	1/4	105	71	21	6	8.5	34	163
50	600 or less	32	27	70	24	46.5	20	40	23	5	4	17	69	10	16	4.2	M8 x 1.25	8	16	M16 x 1.5	32	1/4	106	88	25	8	11	40	179
63	600 or less	32	27	84	24	56.5	20	45	23	5	4	17	69	10	16	4.2	M8 x 1.25	8	16	M16 x 1.5	32	3/8	121	102	25	10	9	47	194

Note 1) Refer to pages 1115 to 1119 for details about the rod end nut, mounting bracket and accessory bracket.
Note 2) When the unit is installed, ensure that dirt does not collect in the rod end (threaded portion).

D-□

-X□

Technical
Data

HYC Series

Construction

With auto switch: HYDCB32 to 63

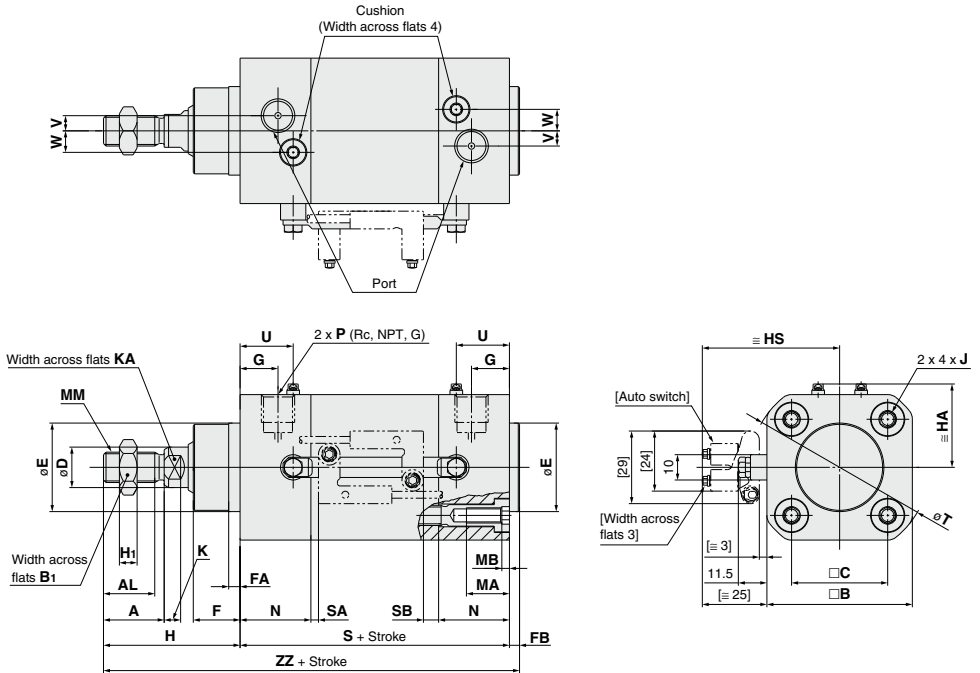

Bore size	Stroke range	A	AL	B	B ₁	C	D	E ^{ø11}	F	FA	FB	G	H	H ₁	MA	MB	J	K	KA	MM	N	P	S	T	U	V	W	SA
32	500 or less	22	18	50	17	32.5	12	30	16	5	4	14	48	6	16	3.2	M6 x 1	6	10	M10 x 1.25	28	1/8	94	62	21	6	6.5	7.5
40	500 or less	24	20	58	19	38	16	35	18.5	4.5	4	15	54	7	16	3.2	M6 x 1	6.5	13	M12 x 1.25	28	1/4	105	71	21	6	8.5	12
50	600 or less	32	27	70	24	46.5	20	40	23	5	4	17	69	10	16	4.2	M8 x 1.25	8	16	M16 x 1.5	32	1/4	106	88	25	8	11	9
63	600 or less	32	27	84	24	56.5	20	45	23	5	4	17	69	10	16	4.2	M8 x 1.25	8	16	M16 x 1.5	32	3/8	121	102	25	10	9	19

Bore size	SB	HS	HA	ZZ
32	16.5	50	30	146
40	23	54	34	163
50	19	60	40	179
63	24	67	47	194

Note 1) The [] value denotes dimensions with the auto switch D-F6□ mounted, which is dedicated to the Hygienic Design Cylinder.
 Note 2) Refer to pages 1115 to 1119 for details about the rod end nut, mounting bracket and accessory bracket.
 Note 3) When the unit is installed, ensure that dirt does not collect in the rod end (threaded portion).

Hygienic Design Cylinder

HYG Series

ø20, ø25, ø32, ø40, ø50, ø63

CJ5
CG5

HY□

Water
Resistant

How to Order

HYG 20 □ R - 50 F

With auto switch
HYDG 20 □ R - 50 F - F6B □

With auto switch (Built-in magnet and switch rail)

Bore size

20	20 mm
25	25 mm
32	32 mm
40	40 mm
50	50 mm
63	63 mm

Port thread type

Nil	M thread	ø20, ø25
	Rc	
TN	NPT	ø32 to ø63
TF	G	

Sealant material

R	NBR
H	External FKM <small>Note</small>

Note) External sealant: Scraper, rod seal, O-ring (rod end) and seal washer are made from FKM.

Auto switch

Nil	Without auto switch
-----	---------------------

Refer to the table below for selection of applicable auto switch.

Number of auto switches

Nil	2 pcs.
S	1 pc.
n	"n" pcs.

Grease

Nil	Standard grease (for non-food)
F	Grease for food

Note) Select grease for food for use in a water dispersion environment or when washing a product with water. (Water resistance is insufficient with standard grease.)

Cylinder stroke

Refer to page 1104 for the standard stroke.

Optional parts (plug bolt) should be ordered separately. Please refer to page 1118 for details.

Applicable Auto Switches/Refer to pages 1575 to 1701 for detailed auto switch specifications.

Type	Electrical entry	Indicator light	Wiring (Output)	Load voltage		Auto switch model	Lead wire length (m)*			Pre-wired connector	Applicable load	
				DC			0.5 (Nil)	3 (L)	5 (Z)			
Solid state auto switch	Grommet	Yes	3-wire (NPN)	24 V	5 V	F6N	●	●	○	○	IC circuit	Relay, PLC
			3-wire (PNP)		12 V	F6P	●	●	○	○		
			2-wire	12 V	F6B	●	●	○	○	—		

* Lead wire length symbols 0.5 m..... Nil (Example) F6B
3 m..... L (Example) F6BL
5 m..... Z (Example) F6BZ

* Auto switches marked with a "○" symbol are produced upon receipt of orders.

• Refer to pages 1648 and 1649 for detailed specifications about the auto switch with pre-wired connector.

* Auto switch is shipped not assembled with the cylinder.

Note) The D-F6□ auto switch has an exterior configuration that reduces residual liquid; it does not feature improved water resistance.

D-□

-X□

Technical
Data



Symbol

Rubber bumper

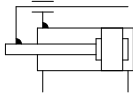

Specifications

Bore size (mm)	20	25	32	40	50	63
Action	Double acting					
Fluid	Air					
Minimum operating pressure	0.2 MPa		0.15 MPa			
Maximum operating pressure	1.0 MPa					
Proof pressure	1.5 MPa					
Ambient and operating fluid temperature	0°C to 60°C					
Lubrication	Not required					
Piston speed	50 to 500 mm/s (With pressure at 1.0 MPa) ^{Note)}					
Cushion	Rubber bumper					
Stroke length tolerance	$^{+1.5}_0$ mm					

Note) Use a cylinder below the allowable kinetic energy. Refer to page 1107 for the allowable kinetic energy.

Standard Stroke

Bore size (mm)	Standard stroke (mm)
20	20, 30, 50, 100, 150, 200
25	20, 30, 50, 100, 150, 200
32	25, 50, 100, 150, 200
40	25, 50, 100, 150, 200
50	25, 50, 100, 150, 200
63	25, 50, 100, 150, 200

* Manufacture of Intermediate Stroke

Intermediate strokes of 1 mm each can be produced by using spacers with standard stroke cylinders. However, intermediate strokes of 5 mm each can be produced about ø40 to 63.

Example) HYG32R-57 mounts a 43 mm spacer in standard stroke cylinder HYG32R-100.

Weight

Without auto switch

Unit: kg

Bore size (mm)	Stroke (mm)						
	20	25	30	50	100	150	200
20	0.77	—	0.86	1.10	1.68	2.24	2.42
25	1.17	—	1.29	1.61	2.40	3.15	3.43
32	—	2.04	—	2.56	3.61	4.59	5.43
40	—	2.31	—	2.90	4.12	5.23	6.17
50	—	3.79	—	4.64	6.43	8.04	9.41
63	—	4.71	—	5.74	7.95	9.92	11.56

With auto switch (Built-in magnet and switch rail)

Unit: kg

Bore size (mm)	Stroke (mm)						
	20	25	30	50	100	150	200
20	0.80	—	0.89	1.12	1.71	2.26	2.45
25	1.19	—	1.32	1.63	2.43	3.18	3.47
32	—	2.07	—	2.60	3.66	4.66	5.51
40	—	2.35	—	2.94	4.96	5.30	6.25
50	—	3.83	—	4.68	6.48	8.11	9.49
63	—	4.75	—	5.79	8.01	9.99	11.65

Theoretical Output

Unit: N

Bore size (mm)	Operating direction	Operating pressure (MPa)		
		0.3	0.5	0.7
20	IN	71	118	165
	OUT	94	157	220
25	IN	113	189	265
	OUT	147	246	344
32	IN	181	302	422
	OUT	241	402	563
40	IN	317	528	739
	OUT	377	629	880
50	IN	495	825	1154
	OUT	589	982	1374
63	IN	841	1402	1962
	OUT	935	1559	2182

Plate Allowable Rotational Torque

Strictly observe the values in the following table regarding rotational torque (T) pressurized to the plate (rod end).

When operated outside of the acceptable range, it can decrease the machine's service life.



Plate Non-rotating Accuracy

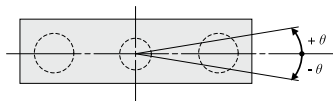

Unit: N·m

Bore size (mm)	Stroke (mm)						
	20	25	30	50	100	150	200
20	0.72	—	0.60	0.57	0.51	0.45	0.37
25	1.29	—	1.18	1.04	0.97	0.83	0.68
32	—	3.23	—	3.07	2.87	2.59	2.24
40	—	3.56	—	3.39	3.16	2.86	2.47
50	—	7.83	—	6.80	5.88	5.25	4.61
63	—	8.83	—	7.67	6.63	5.92	5.20

Bore size (mm)	Non-rotating accuracy θ
20	± 0.10
25	± 0.09
32	± 0.08
40	± 0.08
50	± 0.07
63	± 0.06

* When the cylinder retracts (initial value), for non-rotating accuracy in load-free states and/or except the guide rod deflection, use a value that does not exceed those listed above.

Plate Allowable Moment

Strictly observe the values in the following table regarding allowed moment when eccentric distance is generated from the plate.

When operated outside of the acceptable range, it can decrease the machine's service life.

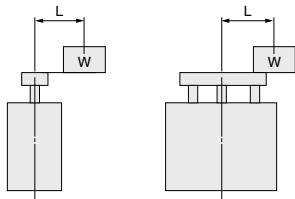

Allowable moment (N·m)	$\phi 20$	$\phi 25$	$\phi 32, \phi 40$	$\phi 50, \phi 63$
		3.57	5.07	21.5

CJ5
CG5

HY□

Water
Resistant

D-□

-X□

Technical
Data

HYG Series

Plate Allowable Lateral Load

Strictly observe the values in the following graph regarding lateral loads hanging upon the plate end point. When operated outside of the acceptable range, it can decrease the machine's service life.

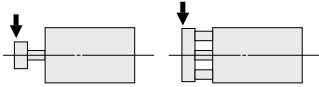

HYG20

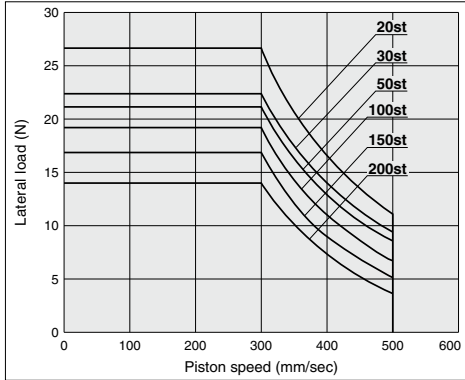

HYG25

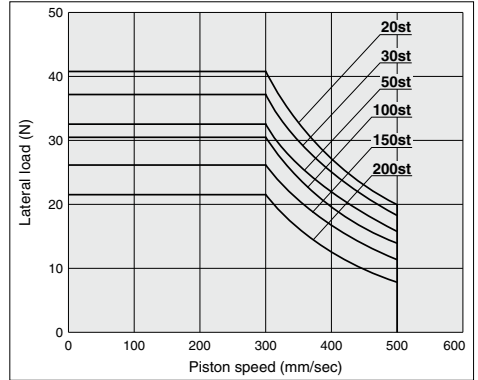

HYG32, 40

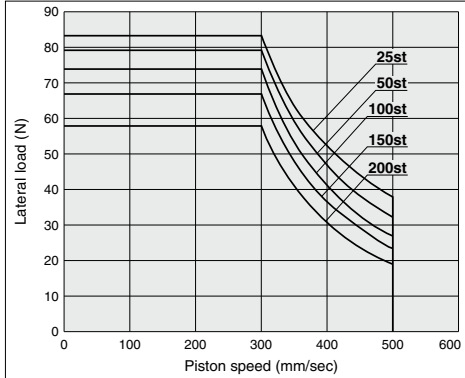

HYG50, 63

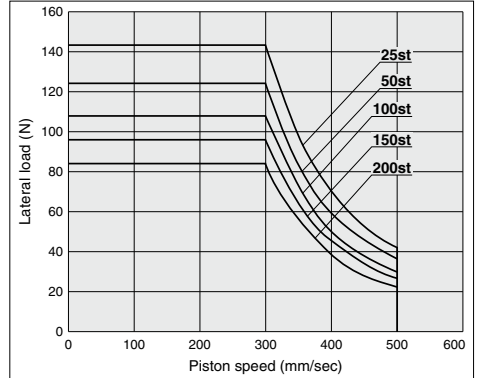

Allowable Kinetic Energy

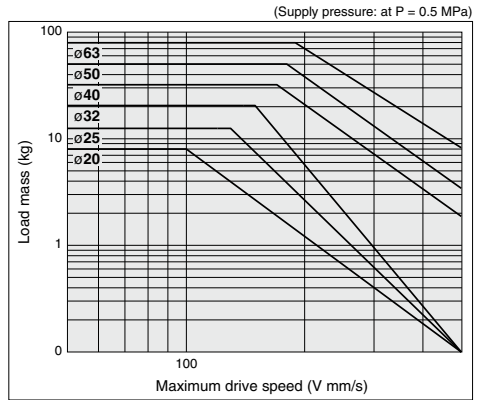
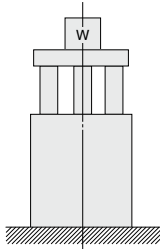

CJ5
CG5
HY
Water
Resistant

Operating Range When Used as Stopper

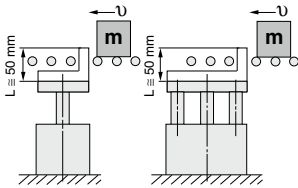

* When selecting a model with a longer L dimension, be sure to choose a sufficiently large bore size.

⚠ Caution
Caution on handling

Note) When using as a stopper
 Bore size ø20 and ø25: Select a model with 30 strokes or less.
 Bore size ø32 to ø63: Select a model with 50 strokes or less.

Bore size ø20 and ø25

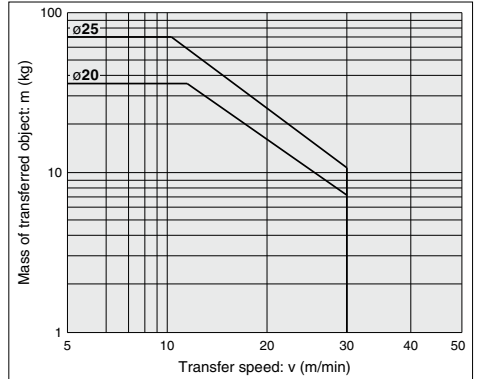

Bore size ø32 to ø63

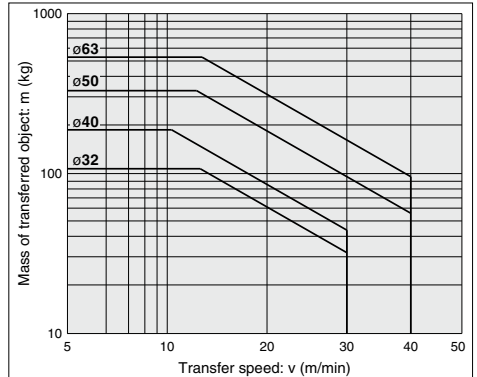

D-
-X
Technical
Data

HYG Series

Construction

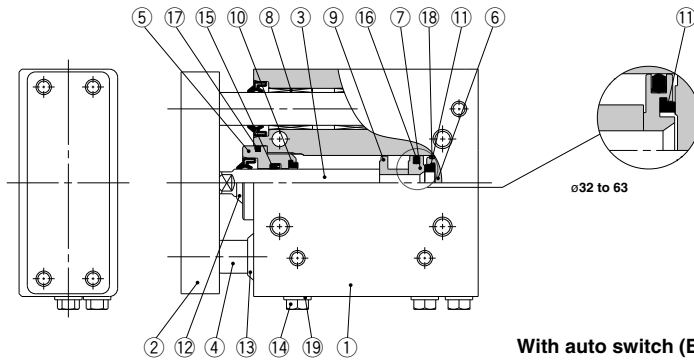

With auto switch (Built-in magnet type)

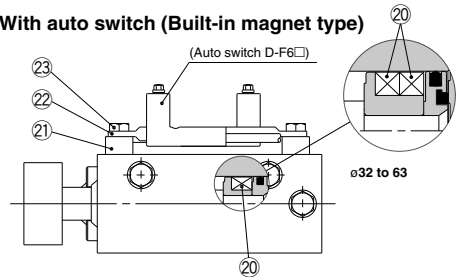

Component Parts

No.	Description	Material	Qty.	Note
1	Body	Aluminum alloy	1	Anodic oxide film
2	Plate	Aluminum alloy	1	Anodic oxide film
3	Piston rod	Stainless steel	1	Hard chromium plated
4	Guide rod	Stainless steel	2	Special coated
5	Rod cover	Aluminum alloy	1	Anodic oxide film
6	Head cover	Aluminum alloy	1	Chromated
7	Piston	Aluminum alloy	1	
8	Bushing	Stainless steel	4	Special coated
9	Magnet holder	Aluminum alloy	1	Chromated
10	Bumper A	Resin	1	
11	Bumper B	Resin	1	
12	Scraper (Piston rod)	Stainless steel+NBR	1	(FKM can be selected.)
13	Scraper (Guide rod)	Stainless steel+NBR	2	(FKM can be selected.)
14	Port plug	Stainless steel	3	
15	Rod seal	NBR	1	(FKM can be selected.)
16	Piston seal	NBR	1	
17	O-ring (Rod end)	NBR	1	(FKM can be selected.)
18	O-ring (Head end)	NBR	1	
19	Seal washer	Stainless steel+NBR	3	(FKM can be selected.)
20	Magnet	—	1	(Only built-in magnet) (Over ø32: 2 magnets)
21	Switch rail base	Stainless steel	2	(Only built-in magnet)
22	Switch rail	Stainless steel	1	(Only built-in magnet)
23	Hexagon bolt	Stainless steel	2	(Only built-in magnet)

Replacement Parts: Seal Kit

Bore size	Part no.	Set contents
20	HYG20□-PS	Set of nos. at left 15, 16, 17 and 19
25	HYG25□-PS	
32	HYG32□-PS	

Place the seal material symbol in □.

Symbol	Material
R	NBR
H	External FKM*

* External seal: Rod seal, O-ring (Rod side) and seal washer are made from FKM.

* Seal kit includes 15, 16, 17 and 19. Order the seal kit based on each bore size.

* Since the seal kit does not include a grease pack, order it separately.

Grease for food part no.: GR-H-010 (10 g)

Standard grease part no.: GR-S-010 (10 g)

⚠ Caution

Please contact SMC to repair or replace seals of cylinder bore size 40 mm and above.

Please contact SMC when the cylinder has to be disassembled for the purpose of replacing seals, etc.

Dimensions: $\varnothing 20, \varnothing 25$

Without auto switch: **HYG20, 25**

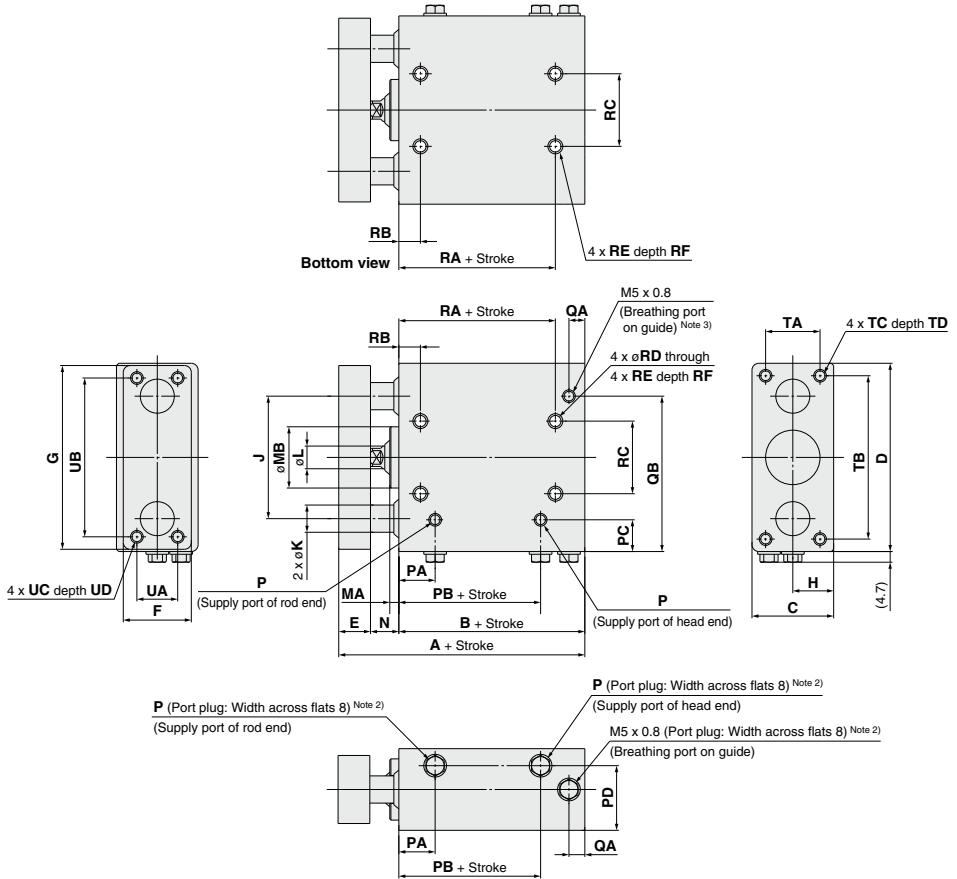

CJ5
CG5
HY□
Water Resistant

Bore size	Standard stroke	A				B				C	D	E	F	G	H	J	K	L	MA	MB	N	P	PA
		30 st or less	31 to 50 st	51 to 100 st	Over 101 st	30 st or less	31 to 50 st	51 to 100 st	Over 101 st														
20	20, 30, 50, 100,	78.5	88.5	108.5	128.5	52	62	82	102	36	83	14	30	81	18	54	12	10	4	27	12.5	M5 x 0.8	16
25	150, 200	86	96	116	136	56.5	66.5	86.5	106.5	42	93	16	38	91	21	64	16	12	4.5	32	13.5	M5 x 0.8	18

Bore size	PB	PC	PD	QA	QB	RA	RB	RC	RD	RE	RF	TA	TB	TC	TD	UA	UB	UC	UD
20	32.5	14	28.5	7	68.5	39	9.5	32	5.4	M6 x 1	12	24	72	M5 x 0.8	13	18	70	M5 x 0.8	10
25	34.5	15	34	8.5	78.5	41.5	9.5	38	5.4	M6 x 1	12	29	80	M6 x 1	14.5	26	78	M6 x 1	12

Note 1) Refer to page 1118 for details about the optional parts (plug bolt).
 Note 2) The figure above shows the status at shipment (top ported). The side ported can be constructed by changing the port plug position.
 Note 3) For piping, refer to Specific Product Precautions.

D-□
-X□
Technical Data

Dimensions: $\varnothing 32$ to $\varnothing 63$

Without auto switch: HYG32 to 63

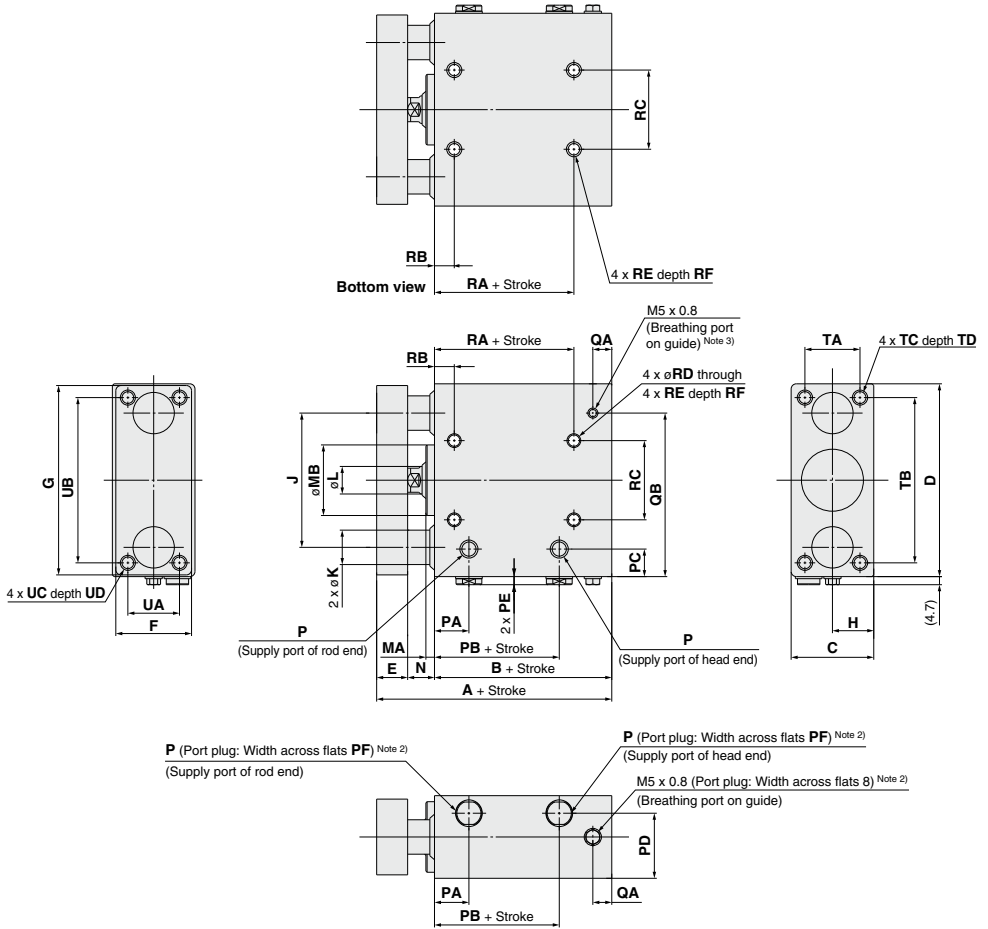

CJ5
CG5

HYG

Water Resistant

Bore size	Stroke	A				B				C	D	E	F	G	H	J	K	L	MA	MB	N
		25 st or less	26 to 50 st	51 to 100 st	Over 101 st	25 st or less	26 to 50 st	51 to 100 st	Over 101 st												
32	25, 50, 100, 150, 200	106.5	116.5	131.5	146.5	73	83	98	113	48	112	18	44	110	24	78	20	16	5	41	15.5
40		106.5	116.5	131.5	146.5	73	83	98	113	54	120	18	44	118	27	86	20	16	5	48	15.5
50		121.5	131.5	146.5	161.5	80	90	105	120	64	148	23	60	146	32	110	25	20	6	59	18.5
63		121.5	131.5	146.5	161.5	80	90	105	120	78	162	23	70	158	39	124	25	20	6	74	18.5

Bore size	P			PA	PB	PC	PD	PE	PF	QA	QB	RA	RB	RC	RD	RE	RF	TA	TB	TC	TD	UA	UB	UC	UD
	Nil	TF	TN																						
32	Rc 1/8	G 1/8	NPT 1/8	20	42.5	16	37.8	4.7	13	11	95	51	11.5	46	6.6	M8 x 1.25	16	32	96	M8 x 1.25	20	30	96	M8 x 1.25	13.5
40	Rc 1/8	G 1/8	NPT 1/8	20.5	40.5	17	42.5	4.7	13	11	103	31	30	50	6.6	M8 x 1.25	16	38	104	M8 x 1.25	20	30	104	M8 x 1.25	13.5
50	Rc 1/4	G 1/4	NPT 1/4	22	41.5	22	52	6.2	16	12.5	129	31	32	63	8.6	M10 x 1.5	20	43	127	M10 x 1.5	22	40	130	M10 x 1.5	17
63	Rc 1/4	G 1/4	NPT 1/4	24	45	23	61	6.2	16	12	143	35	34	76	8.6	M10 x 1.5	20	57	141	M10 x 1.5	22	50	130	M10 x 1.5	17

Note 1) Refer to page 1118 for details about the optional parts (plug bolt).

Note 2) The figure above shows the status at shipment (top ported). The side ported can be constructed by changing the port plug position.

Note 3) For piping, refer to Specific Product Precautions.

D-□

-X□

Technical Data

HYG Series

Dimensions: $\varnothing 32$ to $\varnothing 63$

With auto switch: HYDG32 to 63

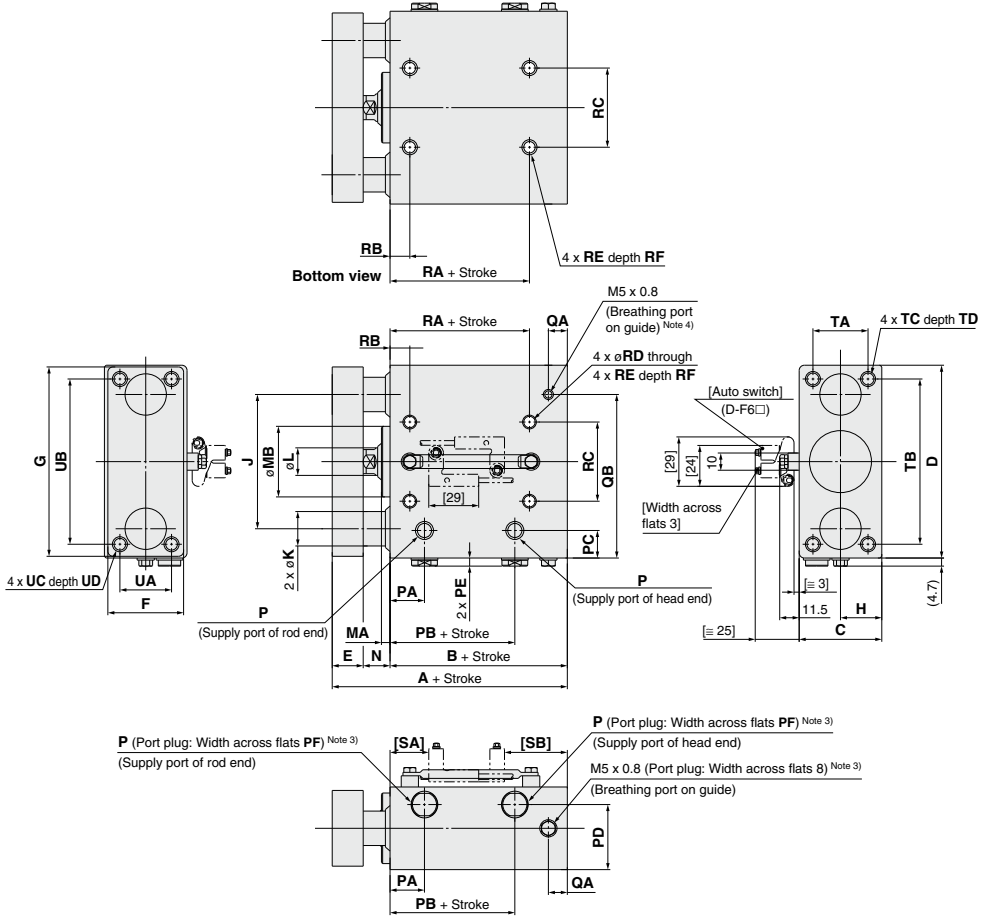

Bore size	Stroke	A												B				C	D	E	F	G	H	J	K	L	MA	MB	N	P			PA
		25 st or less	26 to 50 st	51 to 100 st	Over 101 st	25 st or less	26 to 50 st	51 to 100 st	Over 101 st	NI	TF	TN																					
		32	25, 50, 100, 150, 200	106.5	116.5	131.5	146.5	73	83	98	113	48	112	18	44	110	24													78	20	16	
40	106.5	116.5		131.5	146.5	73	83	98	113	54	120	18	44	118	27	86	20	16	5	48	15.5	Rc 1/8	G 1/8	NPT 1/8	20.5								
50	121.5	131.5		146.5	161.5	80	90	105	120	64	148	23	60	146	32	110	25	20	6	59	18.5	Rc 1/4	G 1/4	NPT 1/4	22								
63		121.5	131.5	146.5	161.5	80	90	105	120	78	162	23	70	158	39	124	25	20	6	74	18.5	Rc 1/4	G 1/4	NPT 1/4	24								

Bore size	PB	PC	PD	PE	PF	QA	QB	RA	RB	RC	RD	RE	RF	SA	SB				TA	TB	TC	TD	UA	UB	UC	UD
															25 st or less	26 to 50 st	51 to 100 st	Over 101 st								
32	42.5	16	37.8	4.7	13	11	95	51	11.5	46	6.6	M8 x 1.25	16	22.5	36.5	46.5	61.5	76.5	32	96	M8 x 1.25	20	30	96	M8 x 1.25	13.5
40	40.5	17	42.5	4.7	13	11	103	31	30	50	6.6	M8 x 1.25	16	21	38	48	63	78	38	104	M8 x 1.25	20	30	104	M8 x 1.25	13.5
50	41.5	22	52	6.2	16	12.5	129	31	32	63	8.6	M10 x 1.5	20	21	45	55	70	85	43	127	M10 x 1.5	22	40	130	M10 x 1.5	17
63	45	23	61	6.2	16	12	143	35	34	76	8.6	M10 x 1.5	20	23.5	42.5	52.5	67.5	82.5	57	141	M10 x 1.5	22	50	130	M10 x 1.5	17

Note 1) The [] value denotes dimensions with the auto switch D-F6□ mounted, which is dedicated to the Hygienic Design Cylinder.

Note 2) Refer to page 1118 for details about the optional parts (plug bolt).

Note 3) The figure above shows the status at shipment (top ported). The side ported can be constructed by changing the port plug position.

Note 4) For piping, refer to Specific Product Precautions.

HY□ Series

Auto Switch Mounting 1

Auto Switch Proper Mounting Position (Detection at stroke end) and Its Mounting Height

HYB

D-H7BA

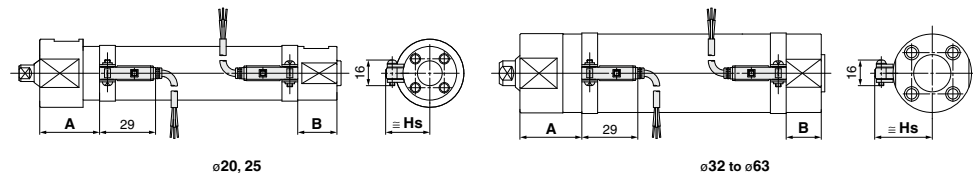

CJ5
CG5

HY□

Water
Resistant

D-G5BA

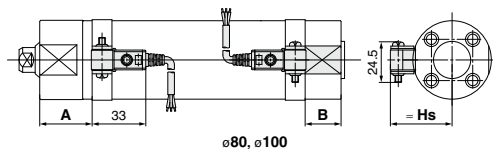

Bore size	D-H7BA			D-G5BA		
	A	B	Hs	A	B	Hs
20	29	19.5	24.5	—	—	—
25	29	19.5	27	—	—	—
32	30	20.5	30.5	—	—	—
40	34.5	22.5	35	—	—	—
50	42	27.5	40.5	—	—	—
63	42	27.5	47.5	—	—	—
80	—	—	—	48	32	59
100	—	—	—	48	32	69.5

Note) The above values are a guide in the stroke end detection of the mounting position of the auto switch. Please adjust in an actual setting after confirming the operating state of the auto switch.

Operating Range

Auto switch model	Bore size							
	20	25	32	40	50	63	80	100
D-H7BA	4	4	4.5	5	6	6.5	—	—
D-G5BA	—	—	—	—	—	—	6.5	7

* Since this is a guideline including hysteresis, it is not meant to be guaranteed. There may be substantial variation depending on the surrounding environment (assuming approximately ±30% dispersion).

Minimum Stroke of Auto Switch Mounting

Auto switch model	1 pc.	2 pcs.
D-H7BA	10	15
D-G5BA	10	15

Auto Switch Mounting Bracket/Part No.

Auto switch model	Bore size (mm)							
	20	25	32	40	50	63	80	100
D-H7BA	BMA2-020AS	BMA2-025AS	BMA2-032AS	BMA2-040AS	BMA2-050AS	BMA2-063AS	—	—
D-G5BA	—	—	—	—	—	—	BA-08 (+)	BA-10 (+)

* When the auto switch bracket above is ordered as a single unit, steel screws are included. When assembling, use the stainless steel screws attached to the auto switches shown below.
Stainless steel mounting screw kit

BBA3; for D-G5BA

• The D-G5BA auto switch is set on the cylinder with the stainless steel screws above when shipped. When an auto switch is shipped independently, BBA3 is attached.

Note 1) Refer to pages 1681 and 1682 for the details of BBA3.

Note 2) The stainless steel screws supplied with the D-H7BA auto switch cannot be used for the D-G5BA.

• Refer to pages 1681 and 1682 for auto switch mounting.

D-□

-X□

Technical
Data

Auto Switch Mounting 2

Auto Switch Proper Mounting Position (Detection at stroke end) and Its Mounting Height

HYQ series

D-F6□

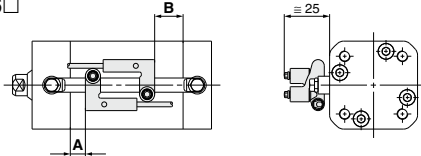

Bore size	(mm)	
	A	B
20	6.5	10.5
25	6.5	11
32	8.5	16
40	10.5	16
50	10.5	17
63	9	18

Note) The above values are a guide in the stroke end detection of the mounting position of the auto switch. Please adjust in an actual setting after confirming the operating state of the auto switch.

HYC series

D-F6□

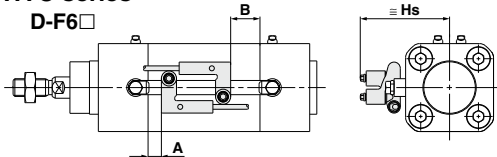

Bore size	(mm)		
	A	B	Hs
32	7.5	16.5	50
40	12	23	54
50	9	19	60
63	19	24	67

Note) The above values are a guide in the stroke end detection of the mounting position of the auto switch. Please adjust in an actual setting after confirming the operating state of the auto switch.

HYG series

D-F6□

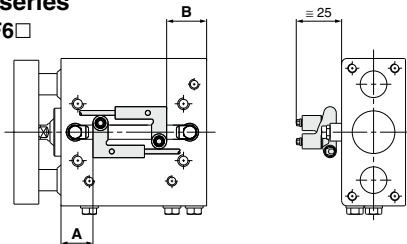

Bore size	A	(mm)			
		B			
		30 st or less	31 to 50 st	51 to 100 st	Over 101 st
20	16	22.5	32.5	52.5	72.5
25	17	25.5	35.5	55.5	75.5
32	22.5	36.5	46.5	61.5	76.5
40	21	38	48	63	78
50	21	45	55	70	85
63	23.5	42.5	52.5	67.5	82.5

Note) The above values are a guide in the stroke end detection of the mounting position of the auto switch. Please adjust in an actual setting after confirming the operating state of the auto switch.

Operating Range

Unit: Operating range [mm]

Auto switch model	Series	Bore size					
		20	25	32	40	50	63
D-F6□	HYQ	7	6	7.5	7.5	7.5	7.5
	HYC	—	—	7.5	7.5	7.5	7.5
	HYG	7	7	8	7.5	7.5	7.5

Note) Since this is a guideline including hysteresis, it is not meant to be guaranteed. There may be substantial variation depending on the surrounding environment (assuming approximately ±30% dispersion).

Minimum Stroke of Auto Switch Mounting

Auto switch model	Series	1 pc.	2 pcs.
D-F6□	HYQ, HYC	5	10
	HYG	10	15

Auto Switch Mounting (HYQ, HYC, HYG common)

Proper tightening torque

When the mounting screw is tightened, use a special tool (D-F6B-650) or torque wrench.

The tightening torque of the M3 mounting screw should be 0.8 to 1.4 N·m.

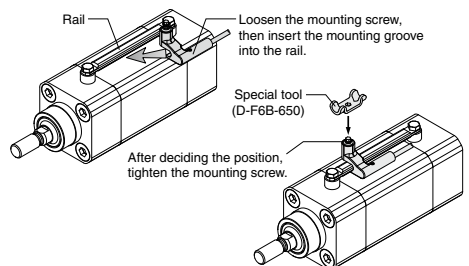

Tighten the screw within the following torque range when the auto switch mounting rail is installed during maintenance.

Screw size	Tightening torque (N·m)
M4	1.1 to 1.9

Tighten the screw within the following torque range when the auto switch is installed on the mounting rail.

Tightening torque (N·m)
0.8 to 1.4

HY□ Series

Mounting Brackets

Foot Bracket

HYB series

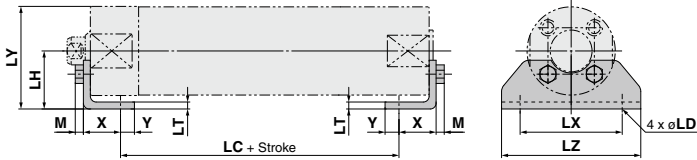

Foot bracket material: Stainless steel
Mounting bolt material: Stainless steel (mm)

Bore size	Bracket part no.	Weight (kg)	X	Y	LD	LH	LC	LT	LX	LY	LZ	M	Mounting bolt
32	CG-L032SUS	0.06	16	6	7.2	25	45	3	44	44	60	3.5	M5 x 0.8
40	CG-L040SUS	0.08	16.5	6.5	7.2	30	51	3	54	53.5	75	4	M6 x 1.0
50	CG-L050SUS	0.17	21.5	11.5	10	40	55	4	66	69	90	5.5	M8 x 1.25
63	CG-L063SUS	0.23	21.5	11.5	12	45	55	4	82	81	110	7	M10 x 1.5
80	CG-L080SUS	0.36	28	17	12	55	60	4	100	99.5	130	7	M10 x 1.5
100	CG-L100SUS	0.69	30	15	14	70	60	6	120	125	160	8	M12 x 1.75

Note 1) Order two foot brackets per cylinder. One mounting bracket is attached with two foot brackets and four mounting bolts.
Note 2) Contact SMC for HYB ø20, ø25.

HYC series

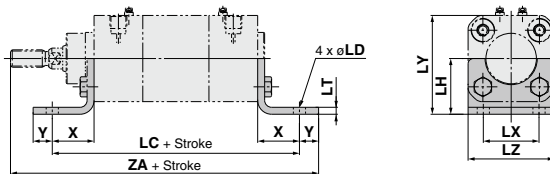

HYQ series

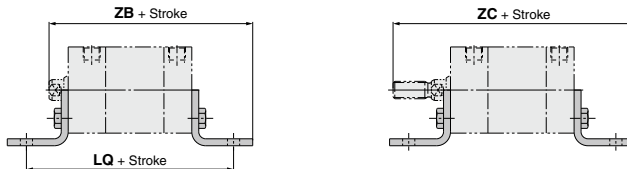

Foot bracket material: Stainless steel
Mounting bolt material: Stainless steel (mm)

Bore size	Bracket part no.	Weight (g)	X	Y	LD	LH	LC	LQ	LT	LX	LY	LZ	HYC		HYQ Without auto switch		HYDQ With auto switch		Mounting bolt
													ZA	ZB	ZC	ZB	ZC		
32	HY-L032SUS	100	24	11	7	32	142	109	4	32	57	49.5	177	107	129	122	144	M6 x 1 x 18L	
40	HY-L040SUS	120	28	10	9	36	161	121.5	4	36	65	57.5	198	115.5	139.5	130.5	154.5	M6 x 1 x 18L	
50	HY-L050SUS	210	32	11	9	45	170	140.5	5	45	80	69	218	133.5	165.5	148.5	180.5	M8 x 1.25 x 20L	
63	HY-L063SUS	260	32	11	9	50	185	141	5	50	92	84	233	134	166	149	181	M8 x 1.25 x 20L	

Note 1) One mounting bracket is attached with one foot bracket and two mounting bolts.
Note 2) Two foot brackets per cylinder should be ordered.
Note 3) Contact SMC for HYQ ø20, ø25.

CJ5
CG5
HY□
Water
Resistant

D-□
-X□

Technical
Data

Flange Bracket

HYB series (Rod end)

Rod end flange bracket (Material: Stainless steel)

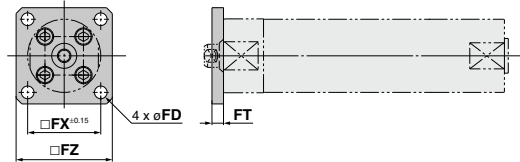

Flange bracket material: Stainless steel
Mounting bolt material: Stainless steel
(mm)

Bore size	Bracket part no.	Weight (kg)	FT	FX	FZ	FD
32	CG-F032SUS	0.10	6	38	50	6.6
40	CG-F040SUS	0.15	6	46	60	6.6
50	CG-F050SUS	0.26	9	58	75	9
63	CG-F063SUS	0.52	9	70	90	11
80	CG-F080SUS	0.66	9	82	100	11
100	CG-F100SUS	1.16	10	100	125	14

Note 1) One mounting bracket is attached with one flange bracket and four mounting bolts.
Note 2) Contact SMC for HYB ø20, ø25.

HYC series (Rod end and head end are common.)

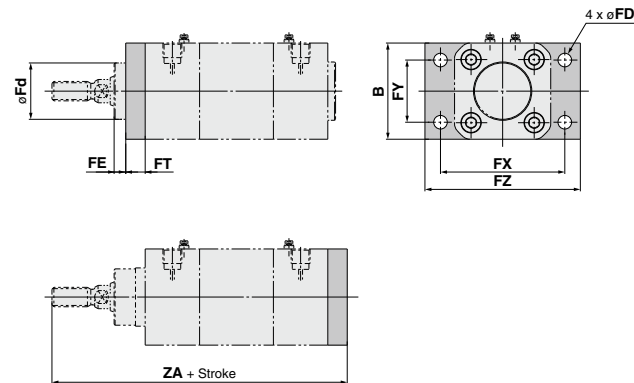

HYQ series

(Rod end and head end are common.)

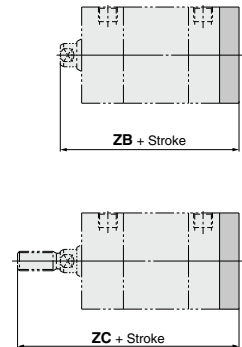

Flange bracket material: Stainless steel
Mounting bolt material: Stainless steel
(mm)

Bore size	Bracket part no.	Weight (g)	B	FD	FE	FT	FX	FY	FZ	Fd	HYC	HYQ		HYDQ		Mounting bolt	
												Without auto switch	With auto switch	Without auto switch	With auto switch		
												ZA	ZB	ZC	ZB	ZC	
32	HY-F032SUS	260	49.5	7	6	10	64	32	80	29	152	82	104	97	119		M6 x 1 x 18L
40	HY-F040SUS	320	57.5	9	8.5	10	72	36	90	34	169	87.5	111.5	102.5	126.5		M6 x 1 x 18L
50	HY-F050SUS	580	69	9	11	12	90	45	110	39	187	102.5	134.5	117.5	149.5		M8 x 1.25 x 20L
63	HY-F063SUS	770	82	9	11	12	100	50	120	44	202	103	135	118	150		M8 x 1.25 x 20L

Note 1) One mounting bracket is attached with 4 mounting bolts.
Note 2) Contact SMC for HYQ ø20, ø25.

Single Clevis Bracket

HYC series

Single clevis bracket material: Stainless steel
Mounting bolt material: Stainless steel (mm)

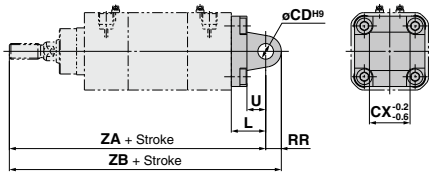

Bore size	Bracket part no.	Weight (g)	L	RR	U	CD ^{H9}	CX ^{0.2-0.6}	HYC	
								ZA	ZB
32	HY-C032SUS	200	22	10	12	10	26	164	174
40	HY-C040SUS	310	25	12	15	12	28	184	196
50	HY-C050SUS	440	27	12	17	12	32	202	214
63	HY-C063SUS	760	32	16	20	16	40	222	238

CJ5
CG5

HY

Water Resistant

HYQ series

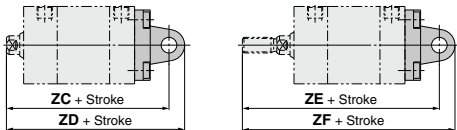

Bore size	Bracket part no.	HYQ / without auto switch			
		ZC	ZD	ZE	ZF
32	HY-C032SUS	94	104	116	126
40	HY-C040SUS	102.5	114.5	126.5	138.5
50	HY-C050SUS	117.5	129.5	149.5	161.5
63	HY-C063SUS	123	139	155	171

Bore size	Bracket part no.	HYDQ / with auto switch				Mounting bolt
		ZC	ZD	ZE	ZF	
32	HY-C032SUS	109	119	131	141	M6 x 1 x 18L
40	HY-C040SUS	117.5	129.5	141.5	153.5	M6 x 1 x 18L
50	HY-C050SUS	132.5	144.5	164.5	176.5	M8 x 1.25 x 20L
63	HY-C063SUS	138	154	170	186	M8 x 1.25 x 20L

Note 1) One mounting bracket is attached with 4 mounting bolts.
Note 2) Contact SMC for HYQ ø20, ø25.

Double Clevis Bracket

HYC series

Double clevis bracket material: Stainless steel
Mounting bolt material: Stainless steel (mm)

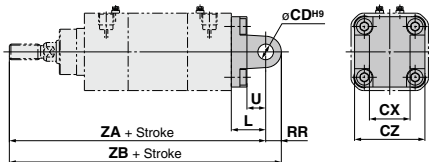

Bore size	Bracket part no.	Weight (g)	L	RR	U	CD ^{H9}	CX ^{H14}	CZ ^{H14}
40	HY-D040SUS	350	25	12	15	12	28	52
50	HY-D050SUS	490	27	12	17	12	32	60
63	HY-D063SUS	810	32	16	20	16	40	70

HYQ series

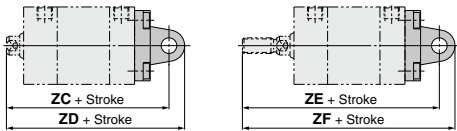

Bore size	Bracket part no.	HYC		HYQ / without auto switch			
		ZA	ZB	ZC	ZD	ZE	ZF
32	HY-D032SUS	164	174	94	104	116	126
40	HY-D040SUS	184	196	102.5	114.5	126.5	138.5
50	HY-D050SUS	202	214	117.5	129.5	149.5	161.5
63	HY-D063SUS	222	238	123	139	155	171

Bore size	Bracket part no.	HYDQ / with auto switch				Mounting bolt
		ZC	ZD	ZE	ZF	
32	HY-D032SUS	109	119	131	141	M6 x 1 x 18L
40	HY-D040SUS	117.5	129.5	141.5	153.5	M6 x 1 x 18L
50	HY-D050SUS	132.5	144.5	164.5	176.5	M8 x 1.25 x 20L
63	HY-D063SUS	138	154	170	186	M8 x 1.25 x 20L

Note 1) One mounting bracket is attached with 4 mounting bolts and clevis pin (HY-E0□SUS) and retaining rings.
Note 2) Contact SMC for HYQ ø20, ø25.

Clevis Pin

Pin material: Stainless steel
Retaining ring material: Stainless steel (mm)

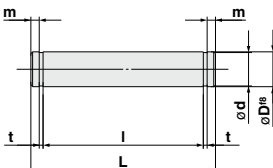

Bore size	Bracket part no.	Weight (g)	D ^ø	L	d	l	m	t	Applied retaining ring
40	HY-E04SUS	60	12	60	11.5	53	2.3	1.2	C type for shaft 12
50	HY-E05SUS	70	12	68	11.5	61	2.3	1.2	C type for shaft 12
63	HY-E06SUS	130	16	78	15.2	71	2.3	1.2	C type for shaft 16

Note 1) One clevis pin is attached with two retaining rings.
Note 2) Contact SMC for HYQ ø20, ø25.

D-□

-X□

Technical Data

HY□ Series Options

Rod End Nut

HYQ, HYC series

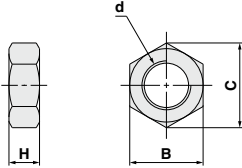

Material: Stainless steel
(mm)

Part no.	Applicable bore size	d	H	B	C
NTH-02SUS	20	M6 x 1.0	3.6	10	11.5
NT-02SUS	25	M8 x 1.25	5	13	15
NT-03SUS	32	M10 x 1.25	6	17	19.6
NTH-04SUS	40	M12 x 1.25	7	19	21.9
NTH-05SUS	50, 63	M16 x 1.5	10	24	27.7

Plug Bolt

Plug bolts are used to close the mounting hole not used.

HYC series

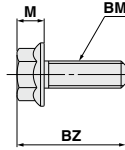
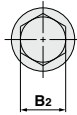

Material: Stainless steel
(mm)

Part no.	Applicable bore size	B2	BM	BZ	M
HYC-H03SUS	32, 40	10	M6 x 1.0	22	6
HYC-H05SUS	50, 63	12	M8 x 1.25	24	8

Note) The above part number is attached with 4 bolts.

HYB, HYG series

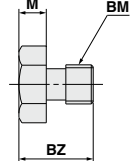
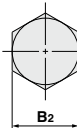

Material: Stainless steel
(mm)

HYB

Part no.	Applicable bore size	B2	BM	BZ	M
HYB-H020SUS	20	7	M4 x 0.7	9	3
HYB-H025SUS	25	8	M5 x 0.8	9.5	3.5
HYB-H025SUS	32	8	M5 x 0.8	9.5	3.5
HYB-H040SUS	40	10	M6 x 1.0	12	4
HYB-H050SUS	50	13	M8 x 1.25	15.5	5.5
HYB-H063SUS	63	17	M10 x 1.5	19	7
HYB-H063SUS	80	17	M10 x 1.5	19	7
HYB-H100SUS	100	19	M12 x 1.75	24	8

Note) The above part number is attached with 4 bolts.

HYG

Part no.	B2	BM	BZ	M
HYG-H020SUS	8	M5 x 0.8	9.5	3.5
HYG-H025SUS	10	M6 x 1.0	12	4
HYG-H032SUS	13	M8 x 1.25	15.5	5.5
HYG-H050SUS	17	M10 x 1.5	19	7

Note) The above part number is attached with 4 bolts.

External Cover

HYQ series/ø20, ø25

Rod end

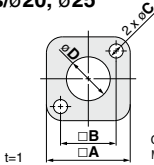

Cover material: Stainless steel
Mounting bolt material: Stainless steel
(mm)

Part no.	A	B	C	D	Installation bolt
HYQ-HA020SUS	32.2	22	5.5	18.5	M5 x 0.8 x 10L
HYQ-HA025SUS	39.2	26	6.6	20.5	M6 x 1.0 x 10L

Note) One mounting bracket is attached with two mounting bolts.

Head end

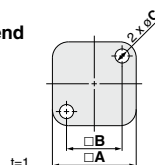

Cover material: Stainless steel
Mounting bolt material: Stainless steel
(mm)

Part no.	A	B	C	Installation bolt
HYQ-HB020SUS	32.2	22	5.5	M5 x 0.8 x 10L
HYQ-HB025SUS	39.2	26	6.6	M6 x 1.0 x 10L

Note) One mounting bracket is attached with two mounting bolts.

HYQ series/ø32 to ø63

Rod end

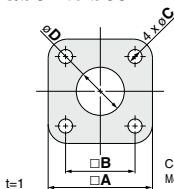

Cover material: Stainless steel
Mounting bolt material: Stainless steel
(mm)

Part no.	A	B	C	D	Installation bolt
HYQ-HA032SUS	48.8	32.5	6.6	22.5	M6 x 1.0 x 10L
HYQ-HA040SUS	56.8	38	6.6	26.5	M6 x 1.0 x 10L
HYQ-HA050SUS	68.2	46.5	8.8	32.5	M8 x 1.25 x 10L
HYQ-HA063SUS	83.2	56.5	8.8	32.5	M8 x 1.25 x 10L

Note) One mounting bracket is attached with four mounting bolts.

Head end

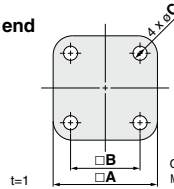

Cover material: Stainless steel
Mounting bolt material: Stainless steel
(mm)

Part no.	A	B	C	Installation bolt
HYQ-HB032SUS	48.8	32.5	6.6	M6 x 1.0 x 10L
HYQ-HB040SUS	56.8	38	6.6	M6 x 1.0 x 10L
HYQ-HB050SUS	68.2	46.5	8.8	M8 x 1.25 x 10L
HYQ-HB063SUS	83.2	56.5	8.8	M8 x 1.25 x 10L

Note) One mounting bracket is attached with four mounting bolts.

Mounting Bolts for HYQB and HYDQB

Mounting method : Mounting bolts for HYQB and HYDQB with through-holes are available.

How to Order : Add "HY-" to the head of the bolt.

Example) Prepare the mounting bolt of cylinder model "HYQB20-5".
The part no. is "HY-M4 x 65L" 2 pcs.

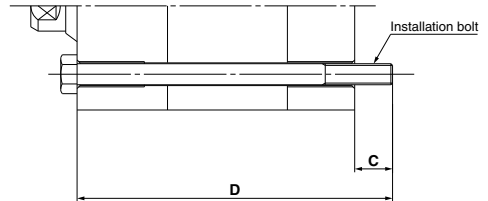

CJ5
CG5
HY
Water Resistant

HYQ/Without built-in magnet

Cylinder model	C	D	Mounting bolt part no.
HYQB20-5	10	65	HY-M4 x 65L
-10		70	x 70L
-15		75	x 75L
-20		80	x 80L
-25		85	x 85L
-30		90	x 90L
-35		95	x 95L
-40		100	x 100L
-45		105	x 105L
-50		110	x 110L
HYQB25-5	9	65	HY-M5 x 65L
-10		70	x 70L
-15		75	x 75L
-20		80	x 80L
-25		85	x 85L
-30		90	x 90L
-35		95	x 95L
-40		100	x 100L
-45		105	x 105L
-50		110	x 110L

Cylinder model	C	D	Mounting bolt part no.
HYQB32-5	9	75	HY-M5 x 75L
-10		80	x 80L
-15		85	x 85L
-20		90	x 90L
-25		95	x 95L
-30		100	x 100L
-35		105	x 105L
-40		110	x 110L
-45		115	x 115L
-50		120	x 120L
-75	145	x 145L	
-100	170	x 170L	
HYQB40-5	9.5	80	HY-M5 x 80L
-10		85	x 85L
-15		90	x 90L
-20		95	x 95L
-25		100	x 100L
-30		105	x 105L
-35		110	x 110L
-40		115	x 115L
-45		120	x 120L
-50		125	x 125L
-75	150	x 150L	
-100	175	x 175L	

Cylinder model	C	D	Mounting bolt part no.
HYQB50-10	13.5	100	HY-M6 x 100L
-15		105	x 105L
-20		110	x 110L
-25		115	x 115L
-30		120	x 120L
-35		125	x 125L
-40		130	x 130L
-45		135	x 135L
-50		140	x 140L
-75		165	x 165L
-100	190	x 190L	
HYQB63-10	13	100	HY-M6 x 100L
-15		105	x 105L
-20		110	x 110L
-25		115	x 115L
-30		120	x 120L
-35		125	x 125L
-40		130	x 130L
-45		135	x 135L
-50		140	x 140L
-75		165	x 165L
-100	190	x 190L	

Material: Stainless steel

HYDQ/With built-in magnet

Cylinder model	C	D	Mounting bolt part no.
HYDQB20-5	10	75	HY-M4 x 75L
-10		80	x 80L
-15		85	x 85L
-20		90	x 90L
-25		95	x 95L
-30		100	x 100L
-35		105	x 105L
-40		110	x 110L
-45		115	x 115L
-50		120	x 120L
HYDQB25-5	9	75	HY-M5 x 75L
-10		80	x 80L
-15		85	x 85L
-20		90	x 90L
-25		95	x 95L
-30		100	x 100L
-35		105	x 105L
-40		110	x 110L
-45		115	x 115L
-50		120	x 120L

Cylinder model	C	D	Mounting bolt part no.
HYDQB32-5	9	90	HY-M5 x 90L
-10		95	x 95L
-15		100	x 100L
-20		105	x 105L
-25		110	x 110L
-30		115	x 115L
-35		120	x 120L
-40		125	x 125L
-45		130	x 130L
-50		135	x 135L
-75	160	x 160L	
-100	185	x 185L	
HYDQB40-5	9.5	95	HY-M5 x 95L
-10		100	x 100L
-15		105	x 105L
-20		110	x 110L
-25		115	x 115L
-30		120	x 120L
-35		125	x 125L
-40		130	x 130L
-45		135	x 135L
-50		140	x 140L
-75	165	x 165L	
-100	190	x 190L	

Cylinder model	C	D	Mounting bolt part no.
HYDQB50-10	13.5	115	HY-M6 x 115L
-15		120	x 120L
-20		125	x 125L
-25		130	x 130L
-30		135	x 135L
-35		140	x 140L
-40		145	x 145L
-45		150	x 150L
-50		155	x 155L
-75		180	x 180L
-100	205	x 205L	
HYDQB63-10	13	115	HY-M6 x 115L
-15		120	x 120L
-20		125	x 125L
-25		130	x 130L
-30		135	x 135L
-35		140	x 140L
-40		145	x 145L
-45		150	x 150L
-50		155	x 155L
-75		180	x 180L
-100	205	x 205L	

D
X
Technical Data



HY□ Series Specific Product Precautions 1

Be sure to read this before handling the products. Refer to back page 50 for Safety Instructions and pages 3 to 12 for Actuator and Auto Switch Precautions.

Caution on Design

⚠ Caution

- Speed adjustment should be conducted in the environment where the cylinder is used. In a different environment, the speed adjustment may be incorrect.
- There are possibilities that dust may accumulate by the usage condition in the thread part and brackets for mounting of this products.

Do measures according to the usage condition when you mount it.

Operating Environment

⚠ Caution

- Avoid installing and using a cylinder inside a food zone.

<Not installable>

Food zone An environment where food which will be sold as merchandize, directly touches the cylinder's components.

<Installable>

Splash zone An environment where food which will not be sold as merchandize, directly touches the cylinder's components.

Non-food zone An environment where there is no contact with food.

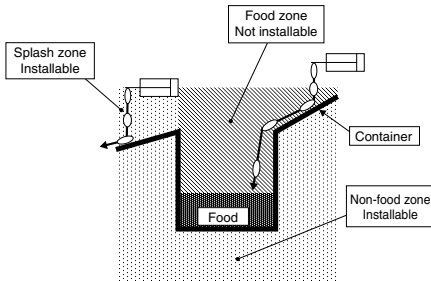

- When a detergent or chemical liquid other than water is splashed on the cylinder, the cylinder's service life may be substantially shortened. Please contact us for details.
- When washing a cylinder with steam, please observe the allowable temperature range of the cylinder and perform for a short period of time.
- When washing a cylinder with a brush, etc., please do not apply excessive force to the auto switch's lead wire, etc.

Mounting

⚠ Warning

- Do not put hands or fingers, etc. between the plate and body. [HYG series]

Care should be taken that hands or fingers do not get caught in between the cylinder body and the plate when air pressure is applied.

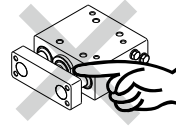

⚠ Caution

- Design the aptitude enough by thinking about the rigidity of mount because the cylinder puts out big power.
- Tighten in following tightening torque when you install the auto switch rail when repairing it.

[HYC and HYQ series]

Thread size	Tightening torque (N·m)
M4	1.1 to 1.9

- Do not apply any force to lead wires when auto switch is mounted on cylinder.

Never apply any force to lead wires. This may not only cause broken lead wires, but it may cause internal elements of the switch to be damaged by the stress. Moreover, the switch might not operate when force applies to the lead wire and the distance between the switch and the cylinder become long.

- Pay attention to magnetic substance density between the auto switch and the cylinder body and the circumference.

When a magnetic substance is brought into close proximity with an auto switch and cylinder, it may cause the auto switch to malfunction due to a loss of the magnetic force inside the cylinder.

- When the cylinder, the support bracket and the plug bolt are mounted, tighten them within below tightening torque.

[HYB series]

Bore size	Thread size	Tightening torque (N·m)
ø20	M4 x 0.7	1.1 to 1.9
ø25, ø32	M5 x 0.8	2.1 to 3.9
ø40	M6 x 1	3.7 to 6.7
ø50	M8 x 1.25	8.8 to 16.2
ø63, ø80	M10 x 1.5	17.2 to 31.8
ø100	M12 x 1.75	29.4 to 54.6

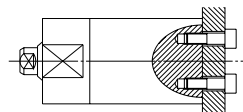



HY□ Series

Specific Product Precautions 2

Be sure to read this before handling the products. Refer to back page 50 for Safety Instructions and pages 3 to 12 for Actuator and Auto Switch Precautions.

Mounting

⚠ Caution

[HYC series]

Bore size	Thread size	Tightening torque (N·m)
ø32, 40	M6 x 1	3.7 to 6.7
ø50, 63	M8 x 1.25	8.8 to 16.2

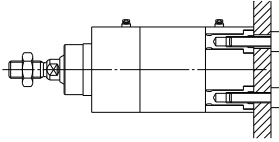

6. When the cylinder, the support bracket and the external cover are mounted, tighten them within below tightening torque. [HYG series]

Bore size	Thread size	Tightening torque (N·m)
ø20	M5 x 0.8	2.1 to 3.9
ø25, 32, 40	M6 x 1	3.7 to 6.7
ø50, 63	M8 x 1.25	8.8 to 16.2

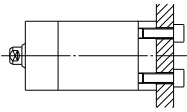

7. When the cylinder, the plug bolt and the load are mounted, tighten within below tightening torque. [HYG series]

Top Mounting

Bore size	Thread size	Tightening torque (N·m)
ø20, 25	M5 x 0.8	2.1 to 3.9
ø32, 40	M6 x 1	3.7 to 6.7
ø50, 63	M8 x 1.25	8.8 to 16.2

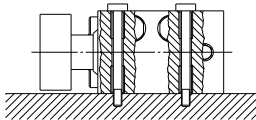

Lower Side Mounting

Bore size	Thread size	Tightening torque (N·m)
ø20, 25	M6 x 1	3.7 to 6.7
ø32, 40	M8 x 1.25	8.8 to 16.2
ø50, 63	M10 x 1.5	17.2 to 31.8

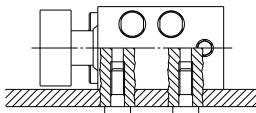

⚠ Caution

Bottom Mounting or Load Mounting

Bore size	Thread size	Tightening torque (N·m)
ø20	M5 x 0.8	2.1 to 3.9
ø25	M6 x 1	3.7 to 6.7
ø32, 40	M8 x 1.25	8.8 to 16.2
ø50, 63	M10 x 1.5	17.2 to 31.8

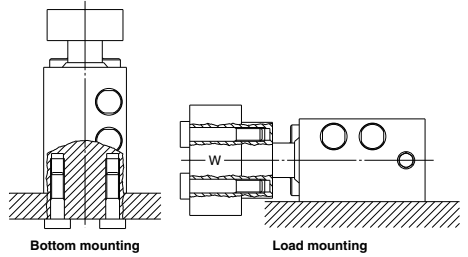

Plug Bolt Mounting (Optional)

Thread size	Tightening torque (N·m)
M5 x 0.8	2.1 to 3.9
M6 x 1	3.7 to 6.7
M8 x 1.25	8.8 to 16.2
M10 x 1.5	17.2 to 31.8

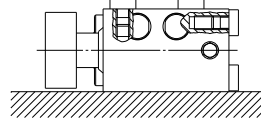

8. Install the load when the piston rod is retracted. [HYG series]

The twist occurs in the guide part if the load is installed on the plate when the piston rod is extended, and it causes the malfunction.

Lubrication

⚠ Caution

1. Lubrication of Hygienic Design Cylinder (standard grease use goods).

This unit can be operated without lubrication. If lubrication is performed, build in the lubricator in the circuit, use turbine oil Class 1 (with no additives) ISO VG-32.

Moreover, the malfunction will occur if the lubrication is discontinued on the way because the disappearance of the initial lubrication part. Lubricate without fail continuously. Consult with SMC if other lubricant are used.

CJ5
CG5

HY□

Water
Resistant

D-□

-X□

Technical
Data



HY□ Series

Specific Product Precautions 3

Be sure to read this before handling the products. Refer to back page 50 for Safety Instructions and pages 3 to 12 for Actuator and Auto Switch Precautions.

Lubrication

⚠ Caution

2. Lubrication to Hygienic Design Cylinder (food compatible grease use goods).

If this unit is lubricated, it might cause the malfunction. Moreover, when a grease out of specification is used, it causes the malfunction.

- Place a purchase order with the following model number when only the grease for maintenance is necessary.
 - Standard grease (for non-food) GR-S-010 (10 g)
 - Food compatible grease GR-H-010 (10 g)

3. Do not wipe off the grease adhering to the sliding part of the air cylinder.

It might cause the malfunction when compulsorily peeling off the adhering grease to the sliding parts. If the cylinder operates the long distance, the sliding parts might become black. In that case, the actuation becomes possible for a long term when the grease of the sliding parts is wiped off once, and it greases it again.

(Wipe off by water. If alcohol and a special solvent are used, the seal might be damaged.)

Cushion (HYC)

⚠ Caution

1. Readjust with the cushion needle.

Readjust the cushion needle installed in the cover according to the load size and the operating speed before use, though it is adjusted to near the fully closed states when it ships. When the cushion adjuster is rotated to clockwise, the throttle strengthens becomes tight and the cushion strengthens will be good.

2. Do not use the cushion needle for a long term in the fully closed states.

It causes the damage of the seal.

3. Torque to the cushion adjuster should be below of the following torque when the cushion needle is adjusted.

Tightening torque (N·m)
0.5

Do not exceed the torque mentioned above. Otherwise it causes the damage.

4. Do not exceed the adjustable range of cushion needle.

If cushion needle is rotated with the torque over adjustable range, it causes the damage.

Bore size	Rotations
ø32, 40	4 or less
ø50, 63	5 or less

Piping

⚠ Caution

1. This product might be damaged if the compressed air is supplied to the breathing port for guide, so do not supply it. [HYG series]

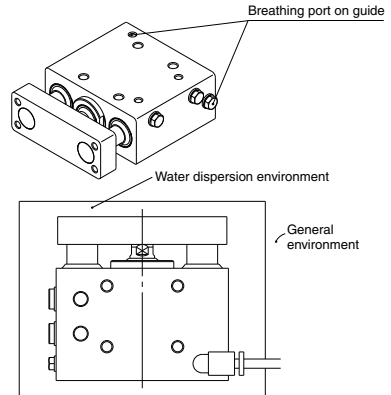

<Example>

- Piping is connected in the breathing port on guide, breathing at general environment is possible.

2. Port plug piping ports and breathing port on guide according to the operating conditions. [HYG series]

Piping Port

Bore size	Port plug thread size	Plug width across flats	Tightening torque (N·m)
ø20, 25	M5	8	After tightening by hand, tighten 1/6 turn.
ø32, 40	1/8	13	7 to 9
ø50, 63	1/4	16	12 to 14

Breathing Port for Guide

Bore size	Port plug thread size	Plug width across flats	Tightening torque (N·m)
ø20 to ø63	M5	8	After tightening by hand, tighten 1/6 turn.

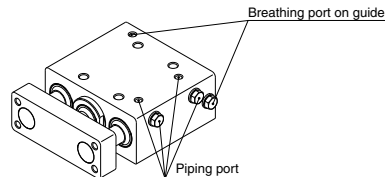

The figure above shows the status at shipment (top ported). The side ported can be constructed by changing the port plug position.

3. Use the piping tube installed in the breathing port for guide is more than ø4 in bore size and within 3 m in length, otherwise the cylinder piston speed might decrease.



HY□ Series

Specific Product Precautions 4

Be sure to read this before handling the products. Refer to back page 50 for Safety Instructions and pages 3 to 12 for Actuator and Auto Switch Precautions.

Caution on Handling

Caution

1. If the sliding parts is washed, the grease will wash out and the service life will be shorten, keep washing at a minimum.
2. Plug up unnecessary mounting holes with plug bolts or external cover (option), etc., bacteria might grow if water gets in these holes.

CJ5
CG5

HY□

Water
Resistant

D-□

-X□

Technical
Data