

# Mechanically Jointed Rodless Cylinder

## MY2 Series

ø16, ø25, ø40



MY1B

MY1H

MY1B

MY1M

MY1C

MY1H

MY1  
HT

MY1  
□W

MY2C

MY2  
H/HT

MY3A

MY3B

MY3M

Compact and low profile design

D-□

-X□

Technical  
Data

# Mechanically Jointed Rodless Cylinder

# MY2 Series

## Compact and low profile design

A complete reduction in height of the cylinder allows mounting in a narrow space. The low profile design of the cylinder built with a high precision single or double axis guide, provides same load capacity as the earlier MY1 series. Three types of guide options to suit a variety of applications.

### MY2C Cam Follower Guide

Available with long stroke

The new MY2C series accommodates longer stroke up to 5000 mm.



### MY2H Single-axis Linear Guide

### MY2HT Double-axis Linear Guide

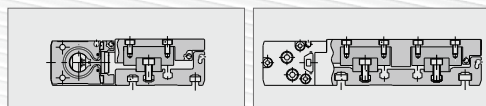

All 3 types have the same cylinder height and actuator (cylinder).

## Increased load capacity

The dynamic load mass has been increased with improved guide performance. (Compared to previous MY1 series.)

### Cam Follower Guide

### Linear Guide

Higher rigidity of the diagonal cam follower and change in the mounting angle provides improved load and moment capacity.

#### MY1C

Diagonal cam follower  
Lateral cam follower

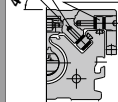

#### MY2C

Diagonal cam follower  
Lateral cam follower

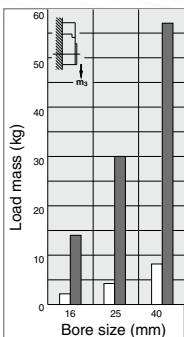
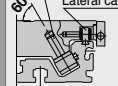

MY2C  
MY1C

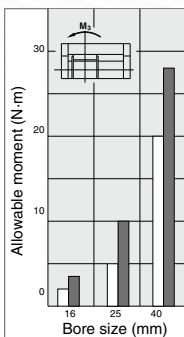

MY2C  
MY1C

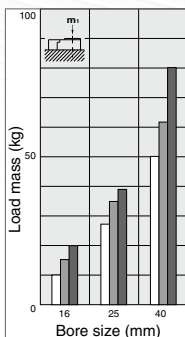

MY2HT  
MY2H  
MY1H

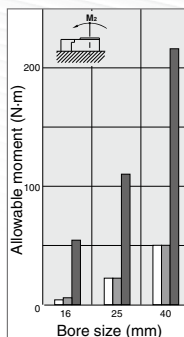

MY2HT  
MY2H  
MY1H

# Height reduction by 30% (Compared to previous MY1 series.)

Low profile achieved by placing the guide unit and cylinder body next to one another. (dimension reduced by 12 mm to 26 mm)

Series	ø16	ø25	ø40
MY2C			
MY2H (Single axis)	28	37	58
MY2HT (Double axis)			
MY1C, MY1H	40	54	84

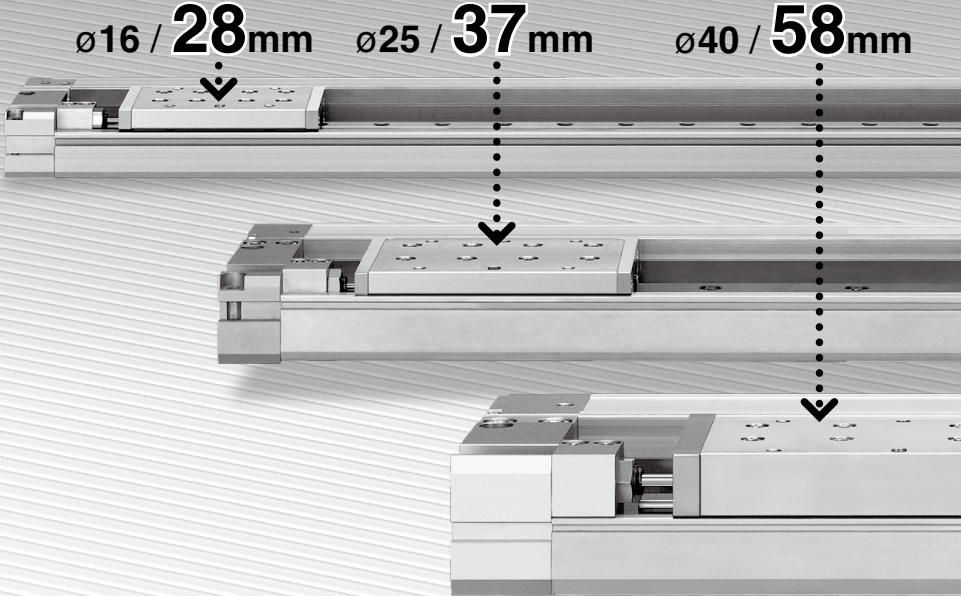

- MY1B
- MY1H
- MY1B
- MY1M
- MY1C
- MY1H
- MY1 HT
- MY1 □W
- MY2C
- MY2 H/HT
- MY3A
- MY3B
- MY3M

ø16 / **28mm**    ø25 / **37mm**    ø40 / **58mm**

## Easy replacement of cylinder body

The cylinder can be replaced without removing the workpiece

The cylinder can be detached by simply removing the four mounting bolts, and pulling it off in the direction of the arrows.

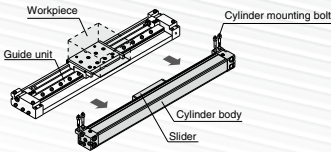

## Improved mounting flexibility

The low profile design allows mounting of heavy-loaded shock absorber (H unit) without interfering with the workpiece.

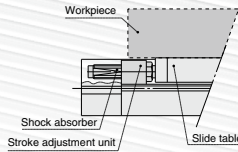

## Two mounting types

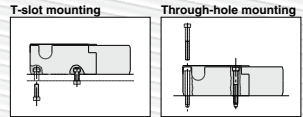

## Auto switch mounting on two sides

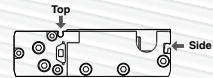

## Option

Optional side support is available (MY2C series)

A side support prevents guide deflection for the long stroke application.

## Standard with air cushion and centralized piping

## Series Variations

Model	Bore size (mm)	Standard stroke (mm)																	Max. available stroke (mm)	Made to order					
		50	100	150	200	250	300	350	400	450	500	550	600	700	800	900	1000	1200			1400	1600	1800	2000	
MY2C Cam follower guide	16																							5000 (3000 for ø16)	Helical insert threads Shock absorber soft type RJ series mounted
MY2H Linear guide/Single axis	25																							1500 (1000 for ø16)	
MY2HT Linear guide/Double axis	40																								

Note) Availability for Made-to-Order differs, depending on the size and the model.

- D
- X

# Model Selection 1

The following are the steps for selection of the MY2 series best suited to your application.

## Standards for Tentative Model Selection

Cylinder model	Guide type	Standards for guide selection	Graphs for related allowable values
<b>MY2C</b>	Cam follower guide	Slide table accuracy approx. $\pm 0.05$ mm <small>Note 2)</small>	Refer to page 1373.
<b>MY2H</b>	Linear guide type (Single axis)	Slide table accuracy $\pm 0.05$ mm or less <small>Note 2)</small>	Refer to page 1374.
<b>MY2HT</b>	Linear guide type (Double axis)	Slide table accuracy $\pm 0.05$ mm or less <small>Note 2)</small>	Refer to page 1375.

Note 1) Please use the precision of each guide as a guideline for selection. Please contact SMC if warranty on precision is required.

Note 2) Accuracy indicates displacement of the table (at stroke end) when 50% of the allowable moment shown in the catalog is applied. (Reference value)

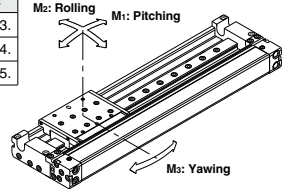

## Selection Flow Chart

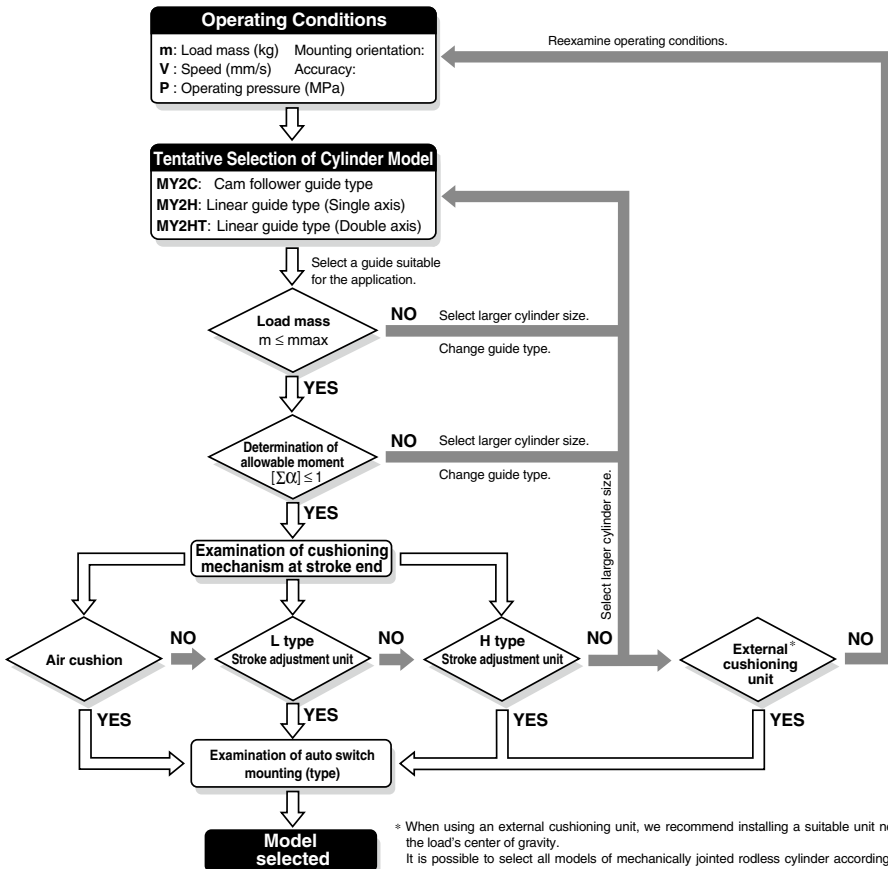

**Types of Moment Applied on Rodless Cylinders**

Multiple moments may be generated depending on the mounting orientation, load, and position of the center of gravity.

**Coordinates and Moments**

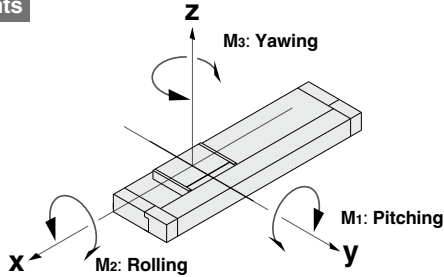

**Static Moment**

**Horizontal mounting**

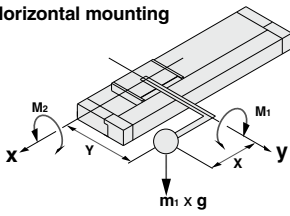

**Ceiling mounting**

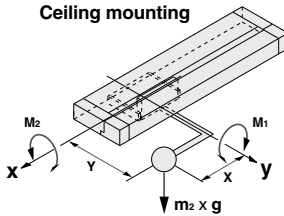

**Wall mounting**

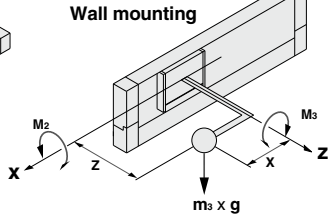

**Vertical mounting**

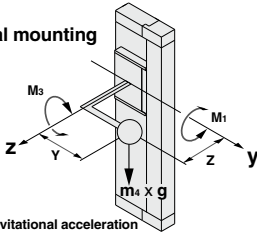

g: Gravitational acceleration

Mounting orientation	Horizontal	Ceiling	Wall	Vertical
Static load m	$m_1$	$m_2$	$m_3$	$m_4$ (Note)
Static moment	M1	$m_1 \times g \times X$	$m_2 \times g \times X$	$m_4 \times g \times Z$
	M2	$m_1 \times g \times Y$	$m_2 \times g \times Y$	—
	M3	—	—	$m_3 \times g \times X$ $m_4 \times g \times Y$

Note)  $m_i$  is a mass movable by thrust. Use 0.3 to 0.7 times the thrust (differs depending on the operating speed) as a guide for actual use.

**Dynamic Moment**

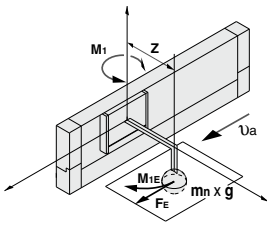

g: Gravitational acceleration,  $U_a$ : Average speed

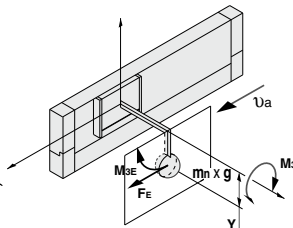

Mounting orientation	Horizontal	Ceiling	Wall	Vertical
Dynamic load $F_E$		$1.4 \times U_a \times m_n \times g$		
Dynamic moment	M1E	$\frac{1}{3} \times F_E \times Z$		
	M2E	Dynamic moment M2E does not occur.		
	M3E	$\frac{1}{3} \times F_E \times Y$		

Note) Regardless of the mounting orientation, dynamic moment is calculated with the formulas above.

MY1B

MY1H

MY1B

MY1M

MY1C

MY1H

MY1 HT

MY1 □W

MY2C

MY2 H/HT

MY3A

MY3B

MY3M

D-□

-X□

Technical Data

## Maximum Allowable Moment/Maximum Load Mass

Model	Bore size (mm)	Maximum allowable moment (N-m)			Maximum load mass (kg)		
		M1	M2	M3	m1	m2	m3
MY2C	16	5	4	3.5	18	16	14
	25	13	14	10	35	35	30
	40	45	33	28	68	66	57
MY2H	16	7	6	7	15	13	13
	25	28	26	26	32	30	30
	40	60	50	60	62	62	62
MY2HT	16	46	55	46	20	18	18
	25	100	120	100	38	35	35
	40	200	220	200	80	80	80

The above values are the maximum allowable values for moment and load. Refer to each graph regarding the maximum allowable moment and maximum load mass for a particular piston speed.

### Load mass (kg)

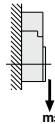

### Moment (N-m)

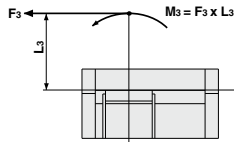
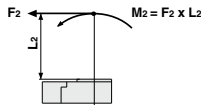
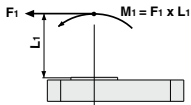

### <Calculation of guide load factor>

1. Maximum load mass (1), static moment (2), and dynamic moment (3) (at the time of impact with stopper) must be examined for the selection calculations.

\* To evaluate, use  $\bar{U}$ a (average speed) for (1) and (2), and  $U$  (impact speed  $U = 1.4\bar{U}$ a) for (3).

Calculate m max for (1) from the maximum load mass graph ( $m_1, m_2, m_3$ ) and  $M_{max}$  for (2) and (3) from the maximum allowable moment graph ( $M_1, M_2, M_3$ ).

$$\text{Sum of guide load factors } \Sigma\alpha = \frac{\text{Load mass [m]}}{\text{Maximum load mass [m max]}} + \frac{\text{Static moment [M]}^{(1)}}{\text{Allowable static moment [Mmax]}} + \frac{\text{Dynamic moment [ME]}^{(2)}}{\text{Allowable dynamic moment [MEmax]}} \leq 1$$

Note 1) Moment caused by the load, etc., with cylinder in resting condition.

Note 2) Moment caused by the impact load equivalent at the stroke end (at the time of impact with stopper).

Note 3) Depending on the shape of the workpiece, multiple moments may occur. When this happens, the sum of the load factors ( $\Sigma\alpha$ ) is the total of all such moments.

### 2. Reference formulas [Dynamic moment at impact]

Use the following formulas to calculate dynamic moment when taking stopper impact into consideration.

- m : Load mass (kg)
- F : Load (N)
- FE : Load equivalent to impact (at impact with stopper) (N)
- $\bar{U}$ a : Average speed (mm/s)
- M : Static moment (N-m)
- $U$  : Impact speed (mm/s)
- $L_1$  : Distance to the load's center of gravity (m)
- ME : Dynamic moment (N-m)
- g : Gravitational acceleration (9.8 m/s<sup>2</sup>)

$$U = 1.4\bar{U}a \text{ (mm/s)} \quad FE = \frac{1.4}{100} \bar{U}a \cdot g \cdot m \text{ (Note 4)}$$

$$\therefore ME = \frac{1}{3} \cdot FE \cdot L_1 = 0.05\bar{U}a \cdot m \cdot L_1 \text{ (N-m) (Note 5)}$$

Note 4)  $\frac{1.4}{100} \bar{U}a$  is a dimensionless coefficient for calculating impact force.

Note 5) Average load coefficient ( $= \frac{1}{3}$ ):  
This coefficient is for averaging the maximum load moment at the time of stopper impact according to service life calculations.

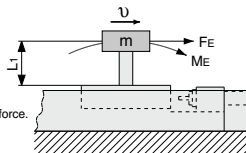

3. Refer to pages 1378 and 1379 for detailed selection procedures.

## Maximum Allowable Moment

Select the moment from within the range of operating limits shown in the graphs. Note that the maximum load mass value may sometimes be exceeded even within the operating limits shown in the graphs. Therefore, also check the allowable load for the selected conditions.

## Maximum Load Mass

Select the load mass from within the range of limits shown in the graphs. Note that the maximum allowable moment value may sometimes be exceeded even within the operating limits shown in the graphs. Therefore, also check the allowable moment for the selected conditions.

Moment/MY2C

MY2C/M<sub>1</sub>

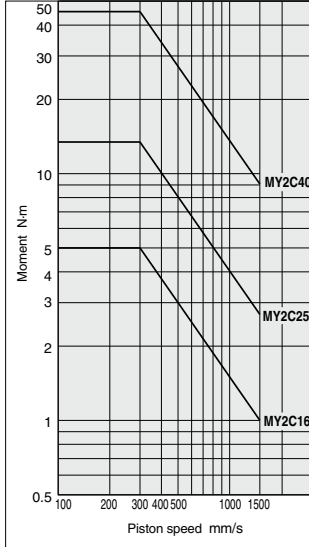

MY2C/M<sub>2</sub>

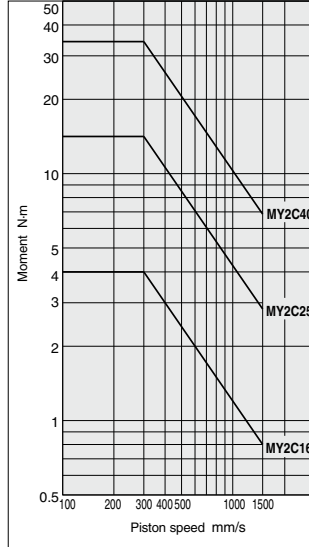

MY2C/M<sub>3</sub>

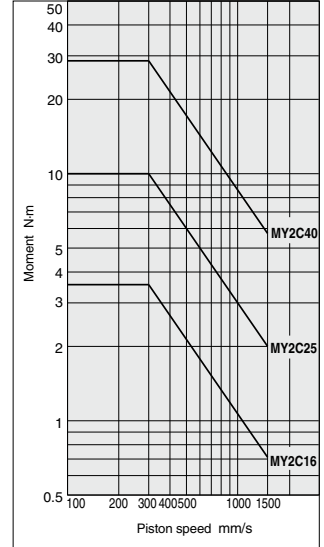

Load Mass/MY2C

MY2C/m<sub>1</sub>

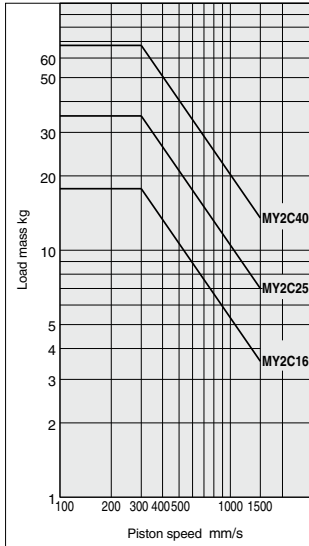

MY2C/m<sub>2</sub>

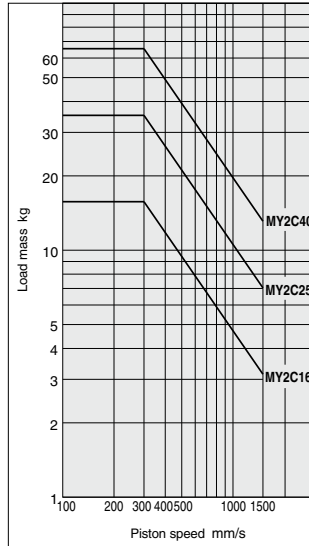

MY2C/m<sub>3</sub>

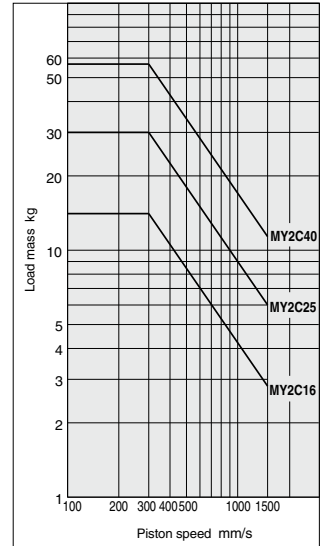

MY1B

MY1H

MY1B

MY1M

MY1C

MY1H

MY1 HT

MY1  
 W

MY2C

MY2 H/HT

MY3A

MY3B

MY3M

D-

-X

Technical Data

# MY2 Series

## Maximum Allowable Moment/Maximum Load Mass

### Moment/MY2H (Single axis)

MY2H/M1

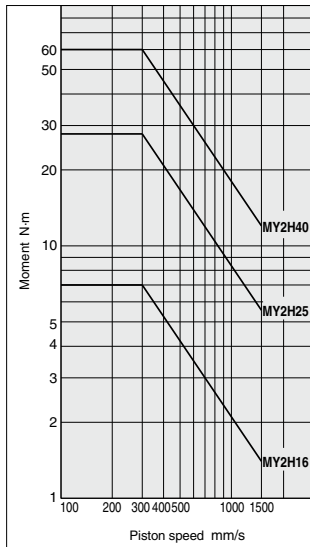

MY2H/M2

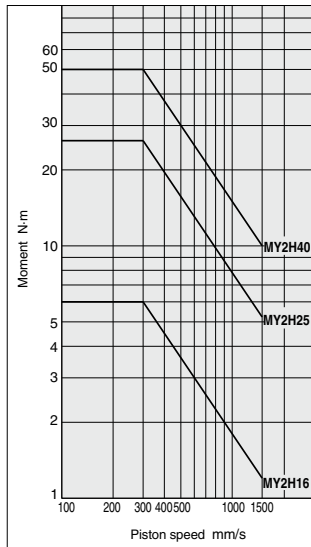

MY2H/M3

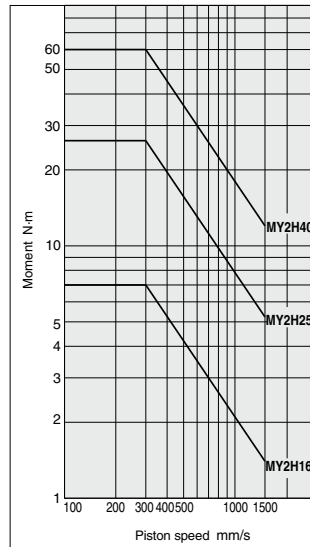

### Load Mass/MY2H (Single axis)

MY2H/m1

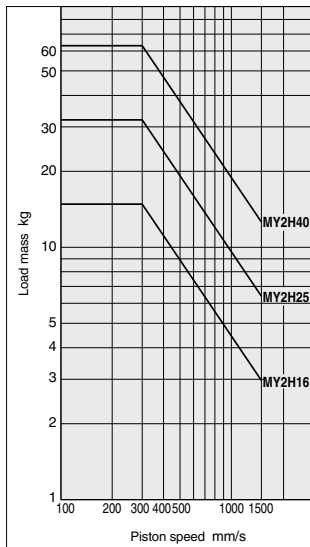

MY2H/m2

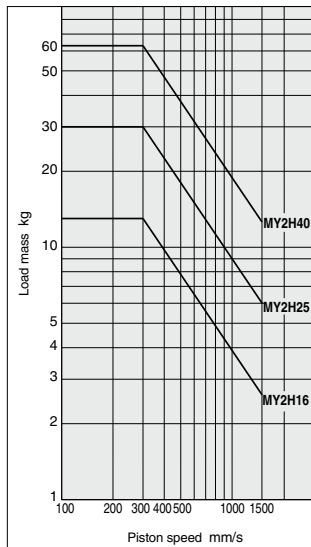

MY2H/m3

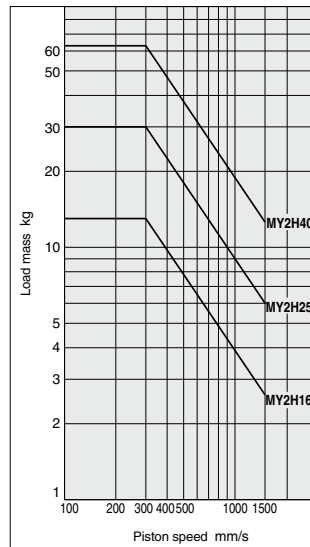



**Moment/MY2HT (Double axis)**

**MY2HT/M1**

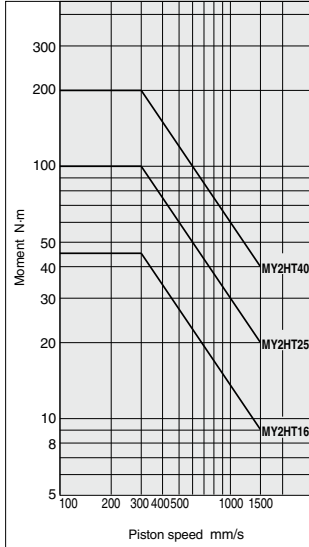

**MY2HT/M2**

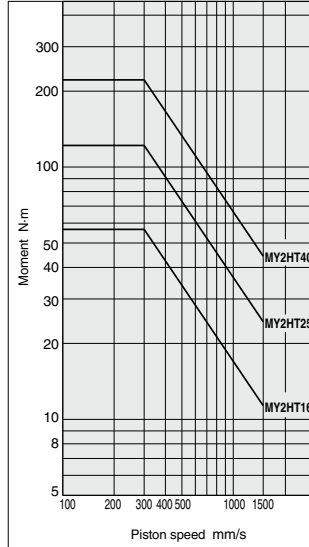

**MY2HT/M3**

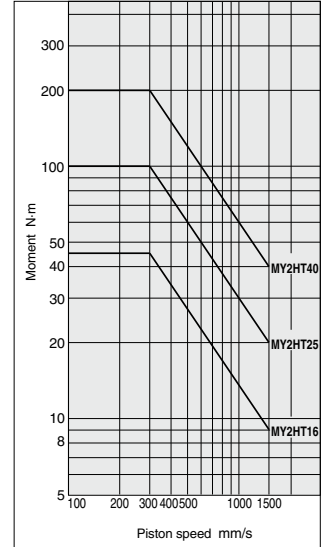

**Load Mass/MY2HT (Double axis)**

**MY2HT/m1**

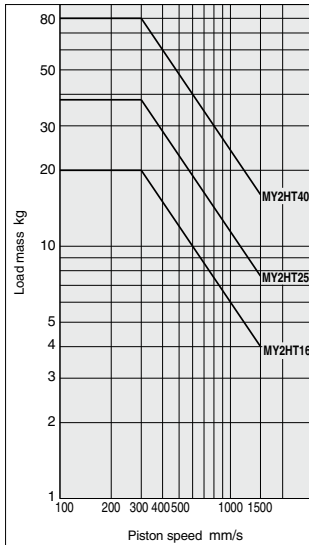

**MY2HT/m2**

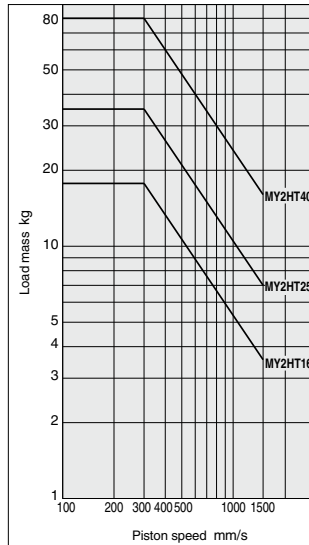

**MY2HT/m3**

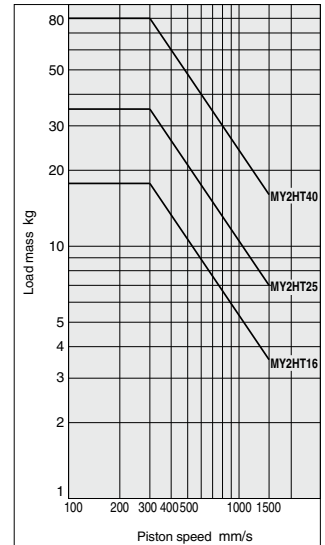

MY1B

MY1H

MY1B

MY1M

MY1C

MY1H

MY1 HT

MY1  W

MY2C

MY2 H/HT

MY3A

MY3B

MY3M

D-

-X

Technical Data

# MY2 Series

## Cushion Capacity

### Cushion Selection

#### <Air cushion>

Air cushions are a standard feature on mechanically jointed rodless cylinders.

The air cushion mechanism is installed to avoid excessive impact of the piston at the stroke end during high speed operation. The air cushion does not act to decelerate the piston near the stroke end.

The ranges of load and speed that air cushions can absorb are within the air cushion limit lines shown in the graphs.

#### <Stroke adjustment unit with shock absorber>

Use this unit when operating with a load or speed exceeding the air cushion limit line, or when cushioning is necessary because the cylinder stroke is outside of the effective air cushion stroke range due to stroke adjustment.

#### L unit

Use this unit when cushioning is necessary outside of the effective air cushion range even if the load and speed are within the air cushion limit line, or when the cylinder is operated in a load and speed range above the air cushion limit line and below the L unit limit line.

#### H unit

Use this unit when the cylinder is operated in a load and speed range above the L unit limit line and below the H unit limit line.

## Caution

Do not use a shock absorber and air cushion together.

### Air Cushion Stroke

Bore size (mm)	Cushion stroke (mm)
16	12
25	15
40	24

### Stroke Adjustment Unit Holding Bolt Tightening Torque

Bore size (mm)	Tightening torque (N·m)
16	0.7
25	1.8
40	5.8

### Calculation of Absorbed Energy for Stroke Adjustment Unit with Shock Absorber

Type of impact	Horizontal	Vertical (downward)	Vertical (upward)
Kinetic energy E <sub>1</sub>	$\frac{1}{2} m \cdot v^2$		
Thrust energy E <sub>2</sub>	F · s	F · s + m · g · s	F · s - m · g · s
Absorbed energy E	E <sub>1</sub> + E <sub>2</sub>		

#### Symbols

v: Speed of impacting object (m/s) m: Mass of impacting object (kg)

F: Cylinder thrust (N) g: Gravitational acceleration (9.8 m/s<sup>2</sup>)

s: Shock absorber stroke (m)

Note) The speed of the impacting object is measured at the time of impact with the shock absorber.

### Absorption Capacity of Air Cushion and Stroke Adjustment Units

#### MY2C16

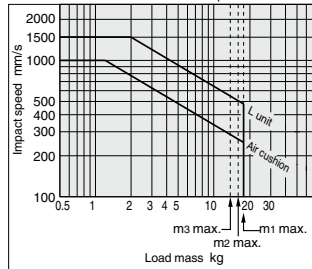

#### MY2H16

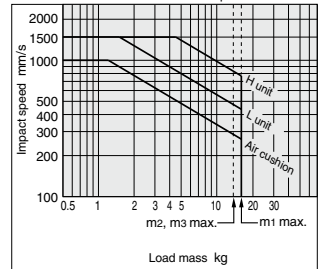

#### MY2C25

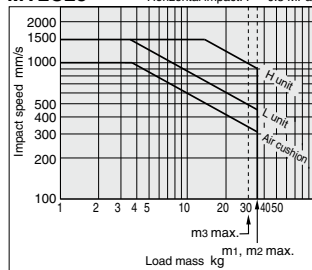

#### MY2H25

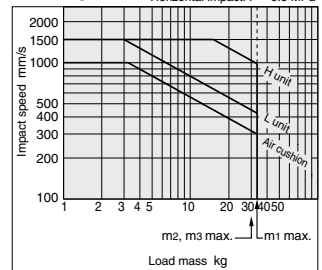

#### MY2C40

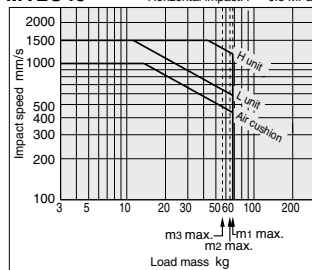

#### MY2H40

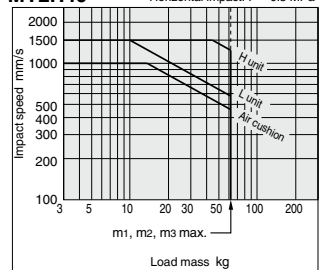

**MY2HT16**

Horizontal impact: P = 0.5 MPa

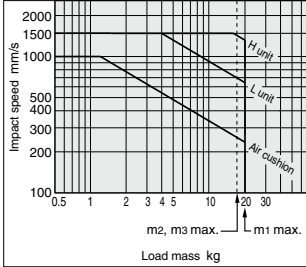

**MY2HT25**

Horizontal impact: P = 0.5 MPa

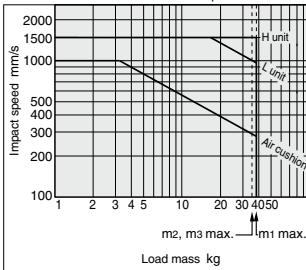

**MY2HT40**

Horizontal impact: P = 0.5 MPa

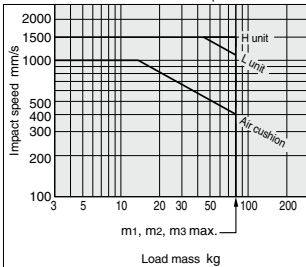

**⚠ Specific Product Precautions**

Be sure to read this before handling the products.  
Refer to back page 50 for Safety Instructions and pages 3 to 12 for Actuator and Auto Switch Precautions.

**Handling**

**⚠ Caution**

1. Do not get your hands caught during cylinder operation.

For the cylinder with a stroke adjustment unit, the space between the slide table and stroke adjustment unit is very small, and your hands may get caught. When operating without a protective cover, be careful not to get your hands caught.

2. Do not operate with the stroke adjustment unit fixed in an intermediate position.

When the stroke adjustment unit is fixed in an intermediate position, slippage can occur depending on the amount of energy released at the time of an impact. In such cases, as a stroke adjustment unit with the spacer for intermediate securing is available, it is recommended to use it. For other lengths, please consult with SMC.

**<Securing the unit body>**

The unit body is secured by equally tightening the two stroke adjustment unit holding bolts. (See drawings below.)

**<Stroke adjustment of shock absorber>**

**For MY2C and MY2H**

Loosen the shock absorber lock nut (shock absorber holding bolts for MY2H16, H unit), and adjust the stroke by rotating the shock absorber. After the adjustment, tighten the lock nut (holding bolts) to secure the shock absorber.

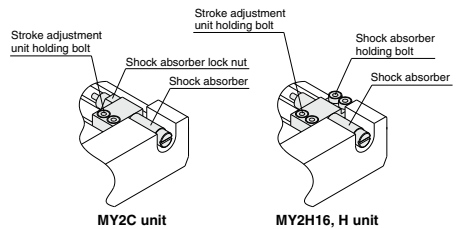

**For MY2HT**

Loosen the two unit holding bolts on the shock absorber side, rotate the shock absorber and adjust the stroke. After the adjustment, secure the shock absorber by tightening the unit holding bolts equally.

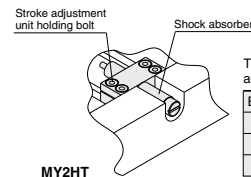

Tightening torque for stroke adjustment unit holding bolts N·m	
Bore size (mm)	Tightening torque
16	0.7
25	1.8
40	5.8

MY1B

MY1H

MY1B

MY1M

MY1C

MY1H

MY1 HT

MY1 □W

MY2C

MY2 H/HT

MY3A

MY3B

MY3M

D-□

-X□

Technical Data

# Model Selection 2

The following are the steps for selection of the MY2 series best suited to your application.

## Calculation of Guide Load Factor

### 1 Operating Conditions

Cylinder ..... MY2H40G-500  
 Average operating speed  $v_a$  ... 300 mm/s  
 Mounting orientation ..... Wall mounting

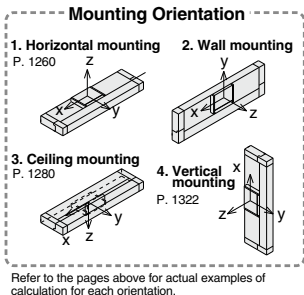
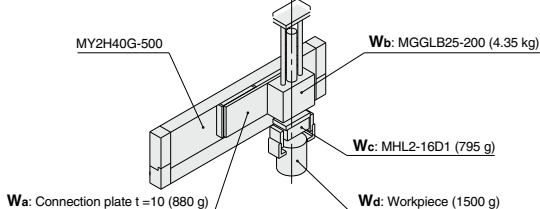

### 2 Load Blocking

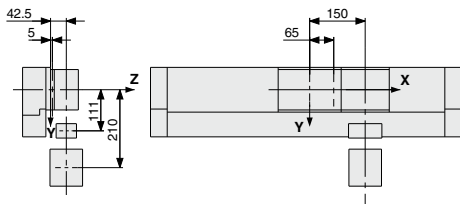

#### Workpiece Mass and Center of Gravity

Workpiece no. $W_n$	Mass $m_n$	Center of gravity		
		X-axis $X_n$	Y-axis $Y_n$	Z-axis $Z_n$
<b>W<sub>a</sub></b>	0.88 kg	65 mm	0 mm	5 mm
<b>W<sub>b</sub></b>	4.35 kg	150 mm	0 mm	42.5 mm
<b>W<sub>c</sub></b>	0.795 kg	150 mm	111 mm	42.5 mm
<b>W<sub>d</sub></b>	1.5 kg	150 mm	210 mm	42.5 mm

n = a, b, c, d

### 3 Composite Center of Gravity Calculation

$$m_3 = \sum m_n = 0.88 + 4.35 + 0.795 + 1.5 = 7.525 \text{ kg}$$

$$X = \frac{1}{m_3} \times \sum (m_n \times x_n) = \frac{1}{7.525} (0.88 \times 65 + 4.35 \times 150 + 0.795 \times 150 + 1.5 \times 150) = 140.1 \text{ mm}$$

$$Y = \frac{1}{m_3} \times \sum (m_n \times y_n) = \frac{1}{7.525} (0.88 \times 0 + 4.35 \times 0 + 0.795 \times 111 + 1.5 \times 210) = 53.6 \text{ mm}$$

$$Z = \frac{1}{m_3} \times \sum (m_n \times z_n) = \frac{1}{7.525} (0.88 \times 5 + 4.35 \times 42.5 + 0.795 \times 42.5 + 1.5 \times 42.5) = 38.1 \text{ mm}$$

### 4 Calculation of Load Factor for Static Load

$m_3$ : Mass

$m_3 \text{ max}$  (from 1 of graph MY2H/ $m_3$ ) = 62 (kg)  
 Load factor  $\alpha_1 = m_3 / m_3 \text{ max} = 7.525/62 = 0.12$

$M_2$ : Moment

$M_2 \text{ max}$  (from 2 of graph MY2H/ $M_2$ ) = 50 (N-m)  
 $M_2 = m_3 \times g \times Z = 7.525 \times 9.8 \times 38.1 \times 10^{-3} = 2.81$  (N-m)  
 Load factor  $\alpha_2 = M_2 / M_2 \text{ max} = 2.81/50 = 0.06$

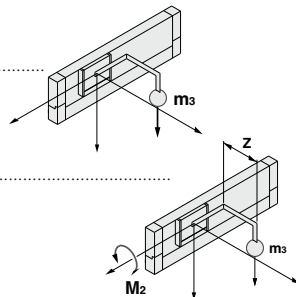

**Calculation of Guide Load Factor**

**M<sub>3</sub>**: Moment

**M<sub>3</sub> max** (from 3 of graph MY2H/M<sub>3</sub>) = 60 (N·m) .....

**M<sub>3</sub> = m<sub>3</sub> × g × X** = 7.525 × 9.8 × 140.1 × 10<sup>-3</sup> = 10.33 (N·m)

Load factor **α<sub>3</sub> = M<sub>3</sub>/M<sub>3</sub> max = 10.33/60 = 0.17**

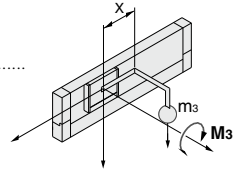

**5 Calculation of Load Factor for Dynamic Moment**

**Equivalent load F<sub>E</sub> at impact**

**F<sub>E</sub> =  $\frac{1.4}{100} \times v_a \times g \times m$**  =  $\frac{1.4}{100} \times 300 \times 9.8 \times 7.525$  = 309.7 (N)

**M<sub>1E</sub>**: Moment

**M<sub>1E</sub> max** (from 4 of graph MY2H/M<sub>1</sub> where 1.4v<sub>a</sub> = 420 mm/s) = 42.9 (N·m) .....

**M<sub>1E</sub> =  $\frac{1}{3} \times F_E \times Z$**  =  $\frac{1}{3} \times 309.7 \times 38.1 \times 10^{-3}$  = 3.93 (N·m)

Load factor **α<sub>4</sub> = M<sub>1E</sub>/M<sub>1E</sub> max = 3.93/42.9 = 0.09**

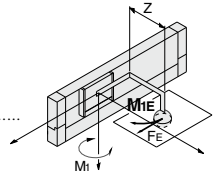

**M<sub>3E</sub>**: Moment

**M<sub>3E</sub> max** (from 5 of graph MY2H/M<sub>3</sub> where 1.4v<sub>a</sub> = 420 mm/s) = 42.9 (N·m) .....

**M<sub>3E</sub> =  $\frac{1}{3} \times F_E \times Y$**  =  $\frac{1}{3} \times 309.7 \times 53.6 \times 10^{-3}$  = 5.53 (N·m)

Load factor **α<sub>5</sub> = M<sub>3E</sub>/M<sub>3E</sub> max = 5.53/42.9 = 0.13**

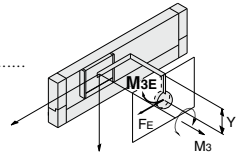

**6 Sum and Examination of Guide Load Factors**

**Σα = α<sub>1</sub> + α<sub>2</sub> + α<sub>3</sub> + α<sub>4</sub> + α<sub>5</sub> = 0.57 ≤ 1**

The above calculation is within the allowable value and the selected model can be used.

Select a separate shock absorber.

In an actual calculation, when the sum of guide load factors Σα in the formula above is more than 1, consider decreasing the speed, increasing the bore size, or changing the product series. Also, this calculation can be performed easily with the "SMC Pneumatics CAD System".

- MY1B
- MY1H
- MY1B
- MY1M
- MY1C
- MY1H
- MY1 HT
- MY1 □W
- MY2C
- MY2 H/HT
- MY3A
- MY3B
- MY3M

**Load Mass**

**MY2H/m<sub>3</sub>**

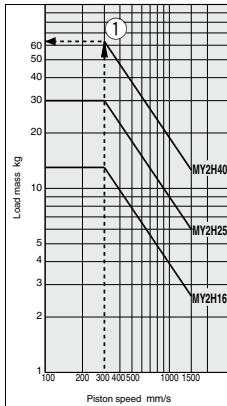

**Allowable Moment**

**MY2H/M<sub>1</sub>**

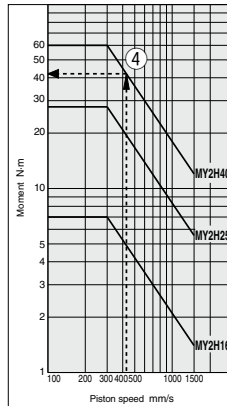

**MY2H/M<sub>2</sub>**

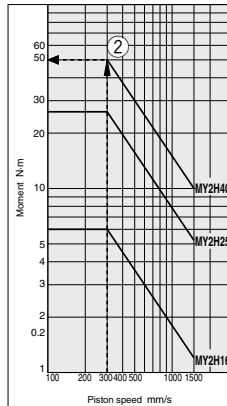

**MY2H/M<sub>3</sub>**

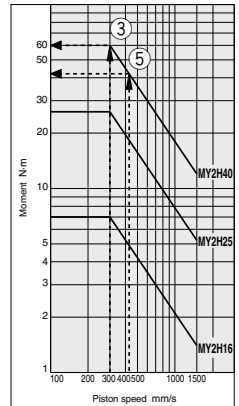

- D-
- X
- Technical Data

# Mechanically Jointed Rodless Cylinder Cam Follower Guide Type **MY2C Series** ø16, ø25, ø40

## How to Order

Cam Follower Guide Type

**MY2C 16** **G** - **300** - **M9BW**

**Guide type**  
C Cam follower guide

**Bore size**  
16 16 mm  
25 25 mm  
40 40 mm

**Port thread type**

Symbol	Type	Bore size
Nil	M thread	ø16
	Rc	
TN	NPT	ø25, ø40
TF	G	

**Piping**  
G Centralized piping type (Standard)

**Cylinder stroke (mm)**

Bore size	Standard stroke* <sup>1</sup>	Long stroke	Maximum manufacturable stroke
16	100, 200, 300, 400, 500, 600, 700, 800, 900, 1000, 1200, 1400, 1600, 1800, 2000	Strokes of 2001 to 3000 mm (1 mm increments) exceeding the standard stroke	3000
25, 40	*1 The stroke can be manufactured in 1 mm increments from 1 mm stroke.	Strokes of 2001 to 5000 mm (1 mm increments) exceeding the standard stroke	5000

Ordering example

\* Long stroke can be ordered the same as the standard stroke. MY2C25-3000L-M9BW

Note) Please be advised that with stroke 49 or less, there are cases where auto switch mounting is not possible and the performance of the air cushion may decline.

**Made to Order**  
Refer to page 1381 for details.

**Number of auto switches**

Nil	2 pcs.
S	1 pc.
n	"n" pcs.

**Auto switch**

Nil	Without auto switch (Built-in magnet)
-----	---------------------------------------

\* Refer to the table below for the applicable auto switch model.

**Stroke adjustment unit symbol**  
Refer to "Stroke adjustment unit" on page 1381.

## Applicable Auto Switches/Refer to pages 1575 to 1701 for further information on auto switches.

Type	Special function	Electrical entry	Indicator light	Wiring (Output)	Load voltage		Auto switch model		Lead wire length (m)				Pre-wired connector	Applicable load	
					DC	AC	Perpendicular	In-line	0.5 (Nil)	1 (M)	3 (L)	5 (Z)		IC circuit	Relay, PLC
Solid state auto switch	—	Grommet	Yes	3-wire (NPN)	24 V	—	M9NV	M9N	●	●	○	○	—	IC circuit	Relay, PLC
				3-wire (PNP)			M9PV	M9P	●	●	○	○			
				2-wire			M9BV	M9B	●	●	○	○			
	3-wire (NPN)			M9NWW			M9NW	●	●	○	○				
	3-wire (PNP)			M9PWW			M9PW	●	●	○	○				
	2-wire			M9BWW			M9BW	●	●	○	○				
Water resistant (2-color indicator)	Grommet	Yes	3-wire (NPN)	24 V	—	M9NAV <sup>#1</sup>	M9NA <sup>#1</sup>	○	○	●	○	—	IC circuit	Relay, PLC	
			3-wire (PNP)			M9PAV <sup>#1</sup>	M9PA <sup>#1</sup>	○	○	○	○				
			2-wire			M9BAV <sup>#1</sup>	M9BA <sup>#1</sup>	○	○	●	○				
Read auto switch	—	Grommet	Yes	3-wire (NPN equivalent)	24 V	12 V	A96V	A96	●	—	●	—	—	IC circuit	—
				No			2-wire	A93V <sup>#2</sup>	A93	●	●	●			
						100 V	A90V	A90	●	—	●	—	—	IC circuit	PLC

\*1 Water resistant type auto switches can be mounted on the above models, but in such case SMC cannot guarantee water resistance.

Consult with SMC regarding water resistant types with the above model numbers.

\*2 1 m type lead wire is only applicable to D-A93.

\* Lead wire length symbols: 0.5 m ..... Nil (Example) M9NW  
1 m ..... M (Example) M9NWM  
3 m ..... L (Example) M9NWL  
5 m ..... Z (Example) M9NWZ

\* Solid state auto switches marked with "○" are produced upon receipt of order.

\* There are other applicable auto switches than listed above. For details, refer to page 1398.

\* For details about auto switches with pre-wired connector, refer to pages 1648 and 1649.

\* Auto switches are shipped together (not assembled). (Refer to page 1398 for the details of auto switch mounting.)

# Mechanically Jointed Rodless Cylinder Cam Follower Guide Type **MY2C Series**

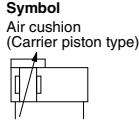
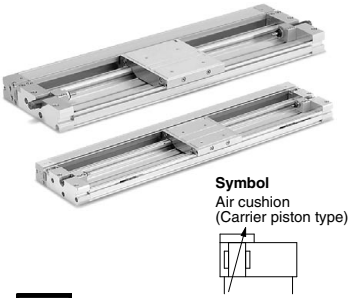

**Made to Order: Individual Specifications**  
(For details, refer to page 1399)

Symbol	Specifications
-X168	Helical insert thread

## Made to Order Specifications

[Click here for details](#)

Symbol	Specifications
-XB22	Shock absorber soft type RJ series type

## Specifications

Bore size (mm)	16	25	40
<b>Fluid</b>	Air		
<b>Action</b>	Double acting		
<b>Operating pressure range</b>	0.15 to 0.8 MPa	0.1 to 0.8 MPa	
<b>Proof pressure</b>	1.2 MPa		
<b>Ambient and fluid temperature</b>	5 to 60°C		
<b>Cushion</b>	Air cushion, Shock absorber		
<b>Lubrication</b>	Not required (Non-lube)		
<b>Stroke length tolerance</b>	1000 or less $^{+1.8}_{-2.8}$ 1001 to 3000 $^{+2.8}_{-0}$	2700 or less $^{+1.8}_{-0}$ , 2701 to 5000 $^{+2.8}_{-0}$	
<b>Port size</b>	M5 x 0.8	Rc 1/8	Rc 1/4

## Piston Speed

Bore size (mm)	16	25	40
<b>Without stroke adjustment unit</b>	100 to 1000 mm/s <sup>(1)</sup>		
<b>Stroke adjustment unit</b>	L unit and H unit 100 to 1500 mm/s		

Note 1) When exceeding the air cushion stroke ranges on page 1376, the **piston speed** should be **100 to 200 mm/s**.

Note 2) Use at a piston speed within the absorption capacity range. Refer to page 1376.

## Stroke Adjustment Unit Specifications

Bore size (mm)	16			25			40			
<b>Unit symbol</b>	<b>L</b>			<b>L</b>	<b>H</b>	<b>L</b>			<b>H</b>	
<b>Shock absorber model</b>	RB0806			RB1007	RB1412	RB1412			RB2015	
<b>Stroke adjustment range by intermediate fixing spacer (mm)</b>	<b>Without spacer</b>		0 to -5.6			0 to -11.5			0 to -16	
	<b>With short spacer</b>		-5.6 to -11.2			-11.5 to -23			-16 to -32	
	<b>With long spacer</b>		-11.2 to -16.8			-23 to -34.5			-32 to -48	

\* Stroke adjustment range is applicable for one side when mounted on a cylinder.

## Stroke Adjustment Unit Symbol

		Right side stroke adjustment unit									
		Without unit	L: With low load shock absorber			H: With high load shock absorber					
Left side stroke adjustment unit	Without unit	Nll	SL	SL6	SL7	SH	SH6	SH7			
		L: With low load shock absorber	LS	L	LL6	LL7	LH	LH6	LH7		
	With short spacer	L6S	L6L	L6	L6L7	L6H	L6H6	L6H7			
		With long spacer	L7S	L7L	L7L6	L7	L7H	L7H6	L7H7		
H: With high load shock absorber	HS	HL	HL6	HL7	H	HH6	HH7				
	With short spacer	H6S	H6L	H6L6	H6L7	H6H	H6	H6H7			
	With long spacer	H7S	H7L	H7L6	H7L7	H7H	H7H6	H7			

\* Spacers are used to fix the stroke adjustment unit at an intermediate stroke position.

## Stroke adjustment unit mounting diagram

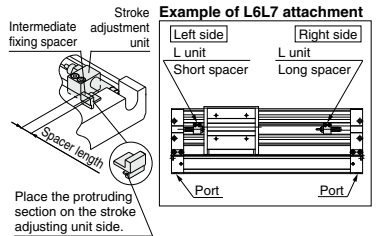

## Shock Absorbers for L and H Units

Type	Stroke adjustment unit	Bore size (mm)		
		16	25	40
Standard (Shock absorber/RB series)	L	RB0806	RB1007	RB1412
	H	—	RB1412	RB2015
Shock absorber/soft type RJ series mounted (-XB22)	L	RJ0806H	RJ1007H	RJ1412H
	H	—	RJ1412H	—

\* The shock absorber service life is different from that of the MY2C cylinder depending on operating conditions. Refer to the RB Series Specific Product Precautions for the replacement period.

\* Mounted shock absorber soft type RJ series (-XB22) is made to order specifications. For details, refer to page 1752.

## Shock Absorber Specifications

Model	RB 0806	RB 1007	RB 1412	RB 2015	
<b>Max. energy absorption (J)</b>	2.9	5.9	19.6	58.8	
<b>Stroke absorption (mm)</b>	6	7	12	15	
<b>Max. collision speed (mm/s)</b>	1500	1500	1500	1500	
<b>Max. operating frequency (cycle/min)</b>	80	70	45	25	
<b>Spring force (N)</b>	<b>Extended</b>	1.96	4.22	6.86	8.34
	<b>Retracted</b>	4.22	6.86	15.98	20.50
<b>Operating temperature range (°C)</b>	5 to 60				

\* The shock absorber service life is different from that of the MY2C cylinder depending on operating conditions. Refer to the RB Series Specific Product Precautions for the replacement period.

MY1B

MY1H

MY1B

MY1M

MY1C

MY1H

MY1 HT

MY1 □W

MY2C

MY2 H/HT

MY3A

MY3B

MY3M

D-□

-X□

Technical Data

# MY2C Series

## Theoretical Output

Bore size (mm)	Piston area (mm <sup>2</sup> )	Operating pressure (MPa)						
		0.2	0.3	0.4	0.5	0.6	0.7	0.8
16	200	40	60	80	100	120	140	160
25	490	98	147	196	245	294	343	392
40	1256	251	377	502	628	754	879	1005

Note) Theoretical output (N) = Pressure (MPa) x Piston area (mm<sup>2</sup>)

## Replacement Parts

### Drive Unit (Cylinder) Replacement Part No.

Bore size (mm)	Model	MY2C
16	MY2BH16G-	Stroke
25	MY2BH25□G-	Stroke
40	MY2BH40□G-	Stroke

Enter a symbol for port thread type inside □.

Note) Order auto switches separately.

## Option

### Stroke Adjustment Unit Part No.

**MY2C - A 25 L2 - 6N**

Stroke adjustment unit

Bore size

16	16 mm
25	25 mm
40	40 mm

Unit no.

Symbol	Stroke adjustment unit	Mounting position
L1	L unit	Left
L2		Right
H1	H unit	Left
H2		Right

Note 1) Refer to page 1381 for details about adjustment range.

Note 2) L unit only for ø16

Intermediate fixing spacer

Nil	Without spacer
6	Short spacer
7	Long spacer

Spacer delivery type

Nil	Unit installed
N	Spacer only

\* Spacers are used to fix the stroke adjustment unit at an intermediate stroke position.

\* Spacers are shipped for a set of two.

Stroke adjustment unit  
Intermediate fixing spacer

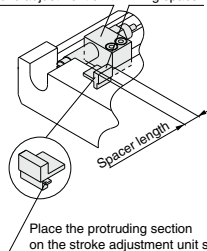

Place the protruding section on the stroke adjustment unit side.

\* When ordering the intermediate fixing spacer for the stroke adjustment unit, the intermediate fixing spacer is shipped together.

## Component Parts

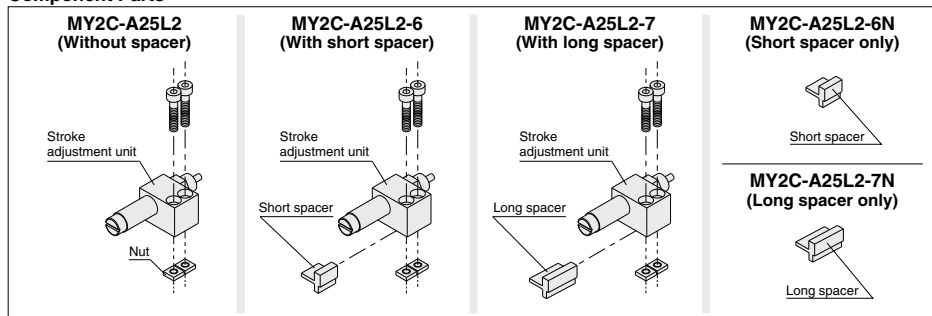

\* Nuts are equipped on the cylinder body.

## Weight

Bore size (mm)	Basic weight	Additional weight per each 50 mm of stroke	Weight of moving parts	Side support bracket weight (per set)	Stroke adjustment unit weight (per unit)	
					L unit weight	H unit weight
16	1.05	0.13	0.34	0.01	0.03	—
25	2.59	0.29	0.97	0.02	0.06	0.09
40	8.78	0.67	3.09	0.04	0.17	0.23

Calculation: (Example) MY2C25G-300L

- Basic weight..... 2.59 kg
- Cylinder stroke..... 300 stroke
- Additional weight..... 0.29/50 stroke  
2.59 + 0.29 x 300/50 + 0.06 x 2 ≒ 4.45 kg
- Weight of L unit..... 0.06 kg



# Mechanically Jointed Rodless Cylinder Cam Follower Guide Type **MY2C Series**

## Construction

### MY2C

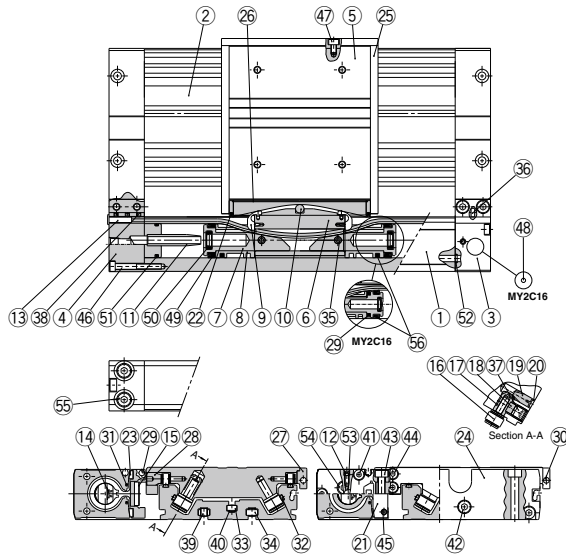

### Component Parts

No.	Description	Material	Note
1	Cylinder tube	Aluminium alloy	Hard anodized
2	Body	Aluminium alloy	Hard anodized
3	Head cover WR	Aluminium alloy	Hard anodized
4	Head cover WL	Aluminium alloy	Hard anodized
5	Slide table	Aluminium alloy	Hard anodized
6	Piston yoke	Aluminium alloy	Hard anodized
7	Piston	Aluminium alloy	Chromated
8	Wear ring	Special resin	
9	Belt separator	Special resin	
10	Parallel pin	Stainless steel	
11	Cushion ring	Aluminium alloy	Anodized
12	Cushion needle	Roller steel	Nickel plated
13	Belt clamp	Special resin	
16	Cam follower	—	
17	Eccentric gear	Stainless steel	
18	Gear fixture	Stainless steel	
19	Adjustment gear	Stainless steel	
20	Retaining ring	Stainless steel	
21	End cover	Aluminium alloy	Hard anodized
23	Bearing	Special resin	
24	End plate	Aluminium alloy	Hard anodized
25	Stopper	Carbon steel	Nickel plated after quenching
26	Top cover	Stainless steel	
27	Side cover	Aluminium alloy	Hard anodized

No.	Description	Material	Note
28	Cam follower cap	Aluminium alloy	Hard anodized
29	Magnet	—	
30	Magnet	—	
31	Seal magnet	Rubber magnet	
32	Rail	Hard steel wire material	
33	Square nut	Carbon steel	Chromated
34	Square nut	Carbon steel	Chromated
35	Spring pin	Carbon tool steel	
36	Parallel pin	Stainless steel	
37	Hexagon socket set screw	Chrome molybdenum steel	Black zinc chromated
38	Hexagon socket set screw	Chrome molybdenum steel	Black zinc chromated
39	Hexagon socket set screw	Chrome molybdenum steel	Chromated
40	Hexagon socket set screw	Chrome molybdenum steel	Chromated
41	Hexagon socket head cap screw	Chrome molybdenum steel	Chromated
42	Hexagon socket head cap screw	Chrome molybdenum steel	Chromated
43	Hexagon socket head cap screw	Chrome molybdenum steel	Chromated
44	Hexagon socket head cap screw	Chrome molybdenum steel	Chromated
45	Hexagon socket head cap screw	Chrome molybdenum steel	Chromated
46	Hexagon socket head cap screw	Chrome molybdenum steel	Chromated
47	Hexagon socket head cap screw	Chrome molybdenum steel	Chromated
48	Steel ball	Spring steel	Nickel plated
54	Hexagon socket head (taper) plug	Carbon steel	Chromated
55	Hexagon socket head (taper) plug	Carbon steel	Chromated
56	Lube retainer	Special resin	

### Replacement Parts: Seal Kit

No.	Description	Qty.	MY2C16G	MY2C25G	MY2C40G
14	Seal belt	1	MY16-16C-[Stroke]	MY25-16C-[Stroke]	MY40-16C-[Stroke]
15	Dust seal band	1	MY2H16-16B-[Stroke]	MY2H25-16B-[Stroke]	MY2H40-16B-[Stroke]
53	O-ring	2	KA00309 (ø4 x ø1.8 x ø1.1)	KA00309 (ø4 x ø1.8 x ø1.1)	KA00320 (ø7.15 x ø3.75 x ø1.7)
22	Scraper	2			
49	Piston seal	2			
50	Cushion seal	2	MY2B16-PS	MY2B25-PS	MY2B40-PS
51	Tube gasket	2			
52	O-ring	4			

\* Seal kit includes 22, 49, 50, 51 and 52. Order the seal kit based on each bore size.

\* Seal kit includes a grease pack (10 g).  
When 14 and 15 are shipped as single units, a grease pack (10 g per 1000 strokes) is included.  
Order with the following part number when only the grease pack is needed.  
Grease pack part number: GR-S-010 (10 g), GR-S-020 (20 g)

MY1B  
MY1H  
MY1B  
MY1M  
MY1C  
MY1H  
MY1 HT  
MY1  
□W  
MY2C  
MY2  
H/HT  
MY3A  
MY3B  
MY3M

D-□  
-X□  
Technical Data

# MY2C Series

ø16, ø25, ø40

Refer to page 1402 regarding port variations.

MY2C Bore size G – Stroke

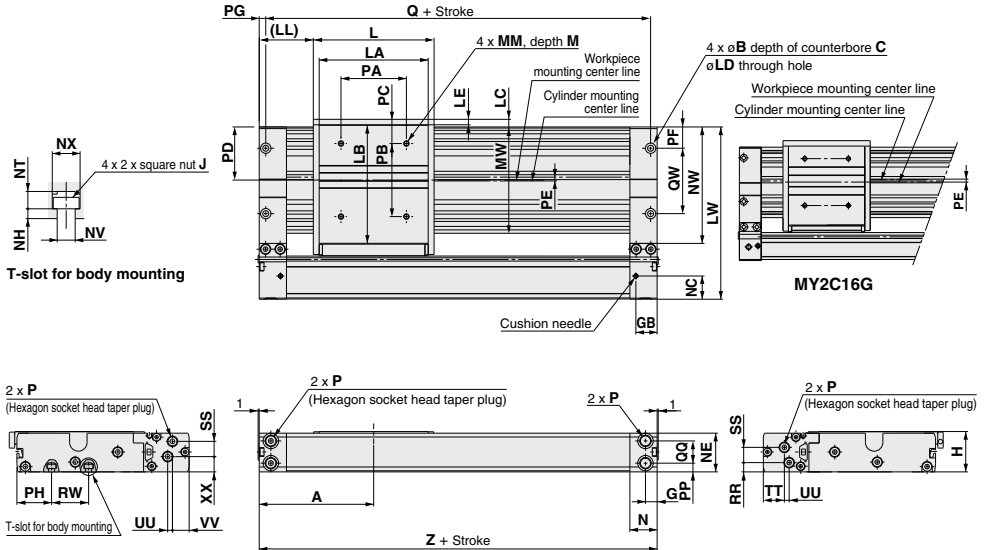

Model	A	B	C	G	GB	H	L	J	LA	LB	LC	LD	LE	(LL)	LW	M	MM	MW	N	NC	NE	NH	NT
MY2C16G	80	6.5	3.3	8.5	17	28	80	M3 x 0.5	70	72.4	6	3.4	5	40	104	7	M4 x 0.7	64.6	20	14	27	2	3.5
MY2C25G	105	9.5	5.4	10.7	19.5	37	110.8	M5 x 0.8	100	108.7	7	5.5	5	49.6	158	9	M5 x 0.8	97.5	25	21.3	35.5	3	5.3
MY2C40G	165	14	8.6	15.5	31.5	58	180	M6 x 1	158	135.3	7	9	5	75	214	13	M6 x 1	121.5	40	32.4	56.5	4	6.5

Model	NV	NW	NX	P	PA	PB	PC	PD	PE	PF	PG	PH	PP	Q	QQ	QW	RR	RW	SS	TT	UU	VV	XX	Z
MY2C16G	3.4	69.2	5.8	M5 x 0.8	40	43	16.5	32	2.2	9.8	4	21.3	5.3	152	16.4	40	5.3	22	9.7	12.5	3	10.5	12	160
MY2C25G	5.5	106.8	8.5	1/8	60	67	22.2	48.7	0.8	19.5	6	31.8	8	198	20.4	60	8.5	34	14	19.3	4.4	15.3	14	210
MY2C40G	6.6	135.1	10.5	1/4	100	77	29	60.5	8.5	40.5	9	38	16	312	25.5	57	11	45	21.5	35.4	2	29	23	330

\*P\* indicates cylinder supply ports. \* The plug for \*P\* MY2C16G is a hexagon socket head plug.

### Stroke adjustment unit

#### Low load shock absorber

MY2C Bore size **G** – Stroke **L**

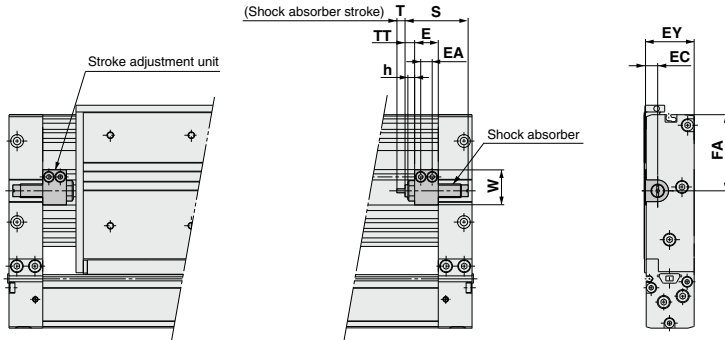

Applicable cylinder	E	EA	EC	EY	FA	h	S	T	TT	W	Shock absorber model
MY2C16	14.4	7	6	27	38.5	4	40.8	6	5.6 (Max. 11.2)	16.5	RB0806
MY2C25	17.5	8.5	9	36	56.4	5	46.7	7	7.1 (Max. 18.6)	25.8	RB1007
MY2C40	25	13	13.5	56.5	67.8	6	67.3	12	10 (Max. 26)	38	RB1412

#### High load shock absorber

MY2C Bore size **G** – Stroke **H**

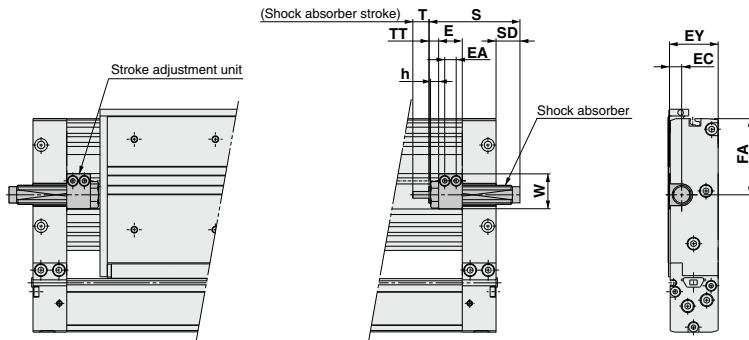

Applicable cylinder	E	EA	EC	EY	FA	h	S	SD	T	TT	W	Shock absorber model
MY2H25	17.5	8.5	9	36	56.4	6	67.3	17.7	12	7.1 (Max. 18.6)	25.8	RB1412
MY2H40	25	13	13.5	56.5	67.8	6	73.2	—	15	10 (Max. 26)	38	RB2015

MY1B

MY1H

MY1B

MY1M

MY1C

MY1H

MY1  
HT

MY1  
□W

**MY2C**

MY2  
H/HT

MY3A

MY3B

MY3M

D-□

-X□

Technical  
Data

# MY2C Series

## Side Support

### Side support MYC-S□A

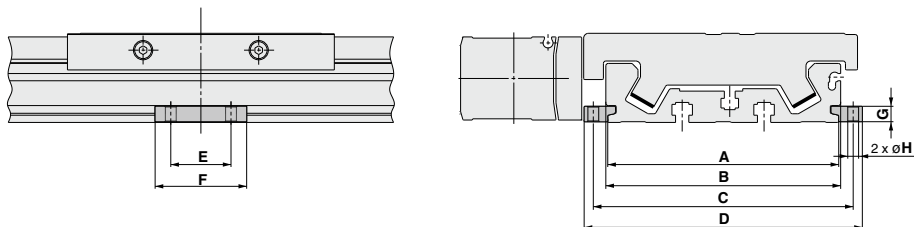

Model	Applicable cylinder	A	B	C	D	E	F	G	øH
MYC-S16A	MY2C16	60.6	64.6	70.6	77.2	15	26	4.9	3.4
MYC-S25A	MY2C25	95.9	97.5	107.9	115.5	25	38	6.4	4.5
MYC-S40A	MY2C40	121.5	121.5	134.5	145.5	45	64	11.7	6.6

\* A set of side supports consists of a left support and a right support.

## Guide for Using Side Support

For long stroke operation, the cylinder tube may deflect due to its own weight and/or load mass. In such cases, install a side support at the intermediate stroke position. The spacing (L) of the side support must be no more than the values shown in the graph at right.

### ⚠ Caution

- ① If the cylinder mounting surfaces are not measured accurately, using a side support may cause poor operation. Make sure to level the cylinder tube when mounting the cylinder. For long stroke operation involving vibration and impact, the use of side supports is recommended even if the support spacing is within the allowable limits shown in the graph.
- ② Support brackets are not for mounting. They should be used only to provide support.

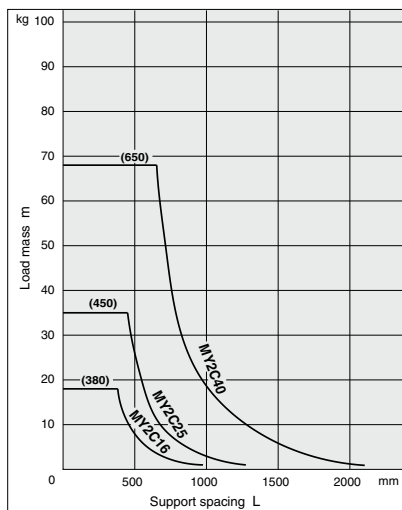
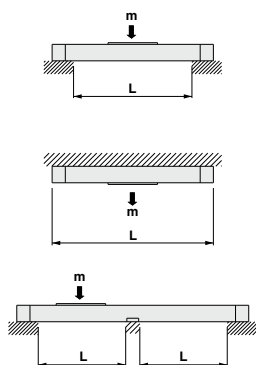

MY1B

MY1H

MY1B

MY1M

MY1C

MY1H

MY1  
HT

MY1  
□W

**MY2C**

MY2  
H/HT

MY3A  
MY3B

MY3M

D-□

-X□

Technical  
Data

# Mechanically Jointed Rodless Cylinder Linear Guide Type

# MY2H/HT Series

ø16, ø25, ø40

## How to Order

Linear Guide Type

**MY2 H 16 G - 300 - M9NW**

### Guide type

<b>H</b>	Linear guide, Single axis
<b>HT</b>	Linear guide, Double axis

### Bore size

<b>16</b>	16 mm
<b>25</b>	25 mm
<b>40</b>	40 mm

### Port thread type

Symbol	Type	Bore size
<b>Nil</b>	M thread	ø16
	Rc	
<b>TN</b>	NPT	ø25, ø40
<b>TF</b>	G	

### Piping

<b>G</b>	Centralized piping type (Standard)
----------	------------------------------------

### Cylinder stroke (mm)

Bore size	Standard stroke	Intermediate stroke	Long stroke	Maximum manufacturable stroke
<b>16</b>	50, 100, 150 200, 250, 300	Intermediate strokes of 51 to 599 mm (1 mm increments) other than standard strokes	Strokes of 601 to 1000 mm (1 mm increments) exceeding the standard stroke	1000
<b>25, 40</b>	350, 400, 450 500, 550, 600		Strokes of 601 to 1500 mm (1 mm increments) exceeding the standard stroke	1500

Ordering example

- \* Intermediate stroke can be ordered the same as the standard stroke. MY2H16-60-M9BW
- \* Long stroke can be ordered the same as the standard stroke. MY2H25-800L-M9BW

• **Made to Order**  
Refer to page 1389  
for details.

• **Number of auto switches**

<b>Nil</b>	2 pcs.
<b>S</b>	1 pc.
<b>n</b>	"n" pcs.

### Auto switch

<b>Nil</b>	Without auto switch (Built-in magnet)
------------	---------------------------------------

\* Refer to the table below for the applicable auto switch model.

### Stroke adjustment unit symbol

Refer to "Stroke adjustment unit" on page 1389.

## Applicable Auto Switches/Refer to pages 1575 to 1701 for further information on auto switches.

Type	Special function	Electrical entry	Indicator light	Wiring (Output)	Load voltage		Auto switch model		Lead wire length (m)				Pre-wired connector	Applicable load		
					DC	AC	Perpendicular	In-line	0.5 (Nil)	1 (M)	3 (L)	5 (Z)				
Solid state auto switch	—	Grommet	Yes	3-wire (NPN)	5 V, 12 V	—	<b>M9NV</b>	<b>M9N</b>	●	●	○	○	IC circuit	Relay, PLC		
				3-wire (PNP)			<b>M9PV</b>	<b>M9P</b>	●	●	○	○				
				2-wire	12 V	<b>M9BV</b>	<b>M9B</b>	●	●	○	○					
				3-wire (NPN)		<b>M9NWV</b>	<b>M9NW</b>	●	●	○	○					
	Diagnostic indication (2-color indicator)	Grommet	Yes	3-wire (PNP)	5 V, 12 V	—	<b>M9PWV</b>	<b>M9PW</b>	●	●	○	○	IC circuit	Relay, PLC		
				2-wire			12 V	<b>M9BWW</b>	<b>M9BW</b>	●	●	○			○	
				3-wire (NPN)	5 V, 12 V	—		<b>M9NAV</b> <sup>*1</sup>	<b>M9NA</b> <sup>*1</sup>	○	○	●			○	IC circuit
				3-wire (PNP)			<b>M9PAV</b> <sup>*1</sup>	<b>M9PA</b> <sup>*1</sup>	○	○	●	○				
Water resistant (2-color indicator)	Grommet	Yes	2-wire	12 V	—	<b>M9BAV</b> <sup>*1</sup>	<b>M9BA</b> <sup>*1</sup>	○	○	●	○	IC circuit	Relay, PLC			
			3-wire (NPN equivalent)			5 V	—	<b>A96V</b>	<b>A96</b>	●	—			●	—	
			2-wire	24 V	12 V			100 V	<b>A93V</b> <sup>*2</sup>	<b>A93</b>	●			●	●	—
						100 V or less	<b>A90V</b>	<b>A90</b>	●	—	●			—		

\*1 Water resistant type auto switches can be mounted on the above models, but in such case SMC cannot guarantee water resistance.

Consult with SMC regarding water resistant types with the above model numbers.

\*2 1 m type lead wire is only applicable to D-A93.

\* Lead wire length symbols: 0.5 m ..... Nil (Example) M9NW  
1 m ..... M (Example) M9NWM  
3 m ..... L (Example) M9NWL  
5 m ..... Z (Example) M9NWZ

\* Solid state auto switches marked with "○" are produced upon receipt of order.

\* There are other applicable auto switches than listed above. For details, refer to page 1398.

\* For details about auto switches with pre-wired connector, refer to pages 1648 and 1649.

\* Auto switches are shipped together (not assembled). (Refer to page 1398 for the details of auto switch mounting.)

# Mechanically Jointed Rodless Cylinder Linear Guide Type **MY2H/HT Series**

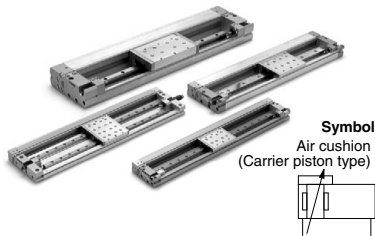

Made to Order

Made to Order: Individual Specifications  
(For details, refer to page 1399)

Symbol	Specifications
-X168	Helical insert thread

## Made to Order Specifications

[Click here for details](#)

Symbol	Specifications
-XB20	Stroke adjusting unit with adjusting bolt
-XB22	Shock absorber soft type RJ series type
-XC56	With knock pin holes

## Stroke Adjustment Unit Specifications

Bore size (mm)		16		25		40	
Unit symbol		L	H	L	H	L	H
Shock absorber model	MY2H	RB0806	RB1007	RB1007	RB1412	RB1412	RB2015
	MY2HT	RB1007	RB1412	RB1412	RB2015	RB2015	RB2725
Stroke adjustment range by intermediate fixing spacer (mm)	Without spacer	0 to -5.6		0 to -11.5		0 to -16	
	With short spacer	-5.6 to -11.2		-11.5 to -23		-16 to -32	
	With long spacer	-11.2 to -16.8		-23 to -34.5		-32 to -48	

\* Stroke adjustment range is applicable for one side when mounted on a cylinder.

## Stroke Adjustment Unit Symbol

		Right side stroke adjustment unit								
		Without unit		L: With low load shock absorber		H: With high load shock absorber				
Left side stroke adjustment unit	Without unit									
		L: With low load shock absorber	With short spacer	SL	SL6	SL7	SH	SH6	SH7	
	With long spacer		L7S	L7L	L76	L7	L7H	L7H6	L7H7	
	H: With high load shock absorber	With short spacer	HS	HL	HL6	HL7	H	HH6	HH7	
With long spacer		H7S	H7L	H7L6	H7L7	H7H	H7H6	H7		

\* Spacers are used to fix the stroke adjustment unit at an intermediate stroke position.

## Shock Absorbers for L and H Units

Model	Type	Stroke adjustment unit	Bore size (mm)		
			16	25	40
MY2H	Standard (Shock absorber/RB series)	L	RB0806	RB1007	RB1412
		H	RB1007	RB1412	RB2015
	Shock absorber/soft type RJ series mounted (-XB22)	L	RJ0806H	RJ1007H	RJ1412H
		H	RJ1007H	RJ1412H	—
MY2HT	Standard (Shock absorber/RB series)	L	RB1007	RB1412	RB2015
		H	RB1412	RB2015	RB2725
	Shock absorber/soft type RJ series mounted (-XB22)	L	RJ1007H	RJ1412H	—
		H	RJ1412H	—	—

\* The shock absorber service life is different from that of the MY2H/HT cylinder depending on operating conditions. Refer to the RB Series Specific Product Precautions for the replacement period.

\* Mounted shock absorber soft type RJ series (-XB22) is made to order specifications. For details, refer to page 1752.

## Specifications

Bore size (mm)	16	25	40
Fluid	Air		
Action	Double acting		
Operating pressure range	0.15 to 0.8 MPa	0.1 to 0.8 MPa	
Proof pressure	1.2 MPa		
Ambient and fluid temperature	5 to 60°C		
Cushion	Air cushion, Shock absorber		
Lubrication	Not required (Non-lube)		
Stroke length tolerance	+1.8 0		
Port size	M5 x 0.8	Rc 1/8	Rc 1/4

## Piston Speed

Bore size (mm)		16	25	40
Without stroke adjustment unit		100 to 1000 mm/s <sup>Note 1)</sup>		
Stroke adjustment unit	L unit and H unit	100 to 1500 mm/s		

Note 1) When exceeding the air cushion stroke ranges on page 1376, the piston speed should be 100 to 200 mm/s.

Note 2) Use at a piston speed within the absorption capacity range. Refer to page 1376.

## Stroke adjustment unit mounting diagram

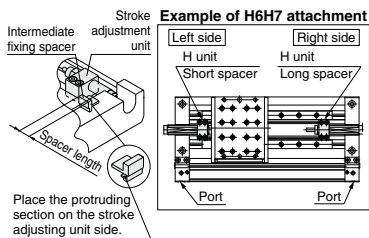

## Shock Absorber Specifications

Model	RB 0806	RB 1007	RB 1412	RB 2015	RB 2725	
Max. energy absorption (J)	2.9	5.9	19.6	58.8	147	
Stroke absorption (mm)	6	7	12	15	25	
Max. collision speed (mm/s)	1500	1500	1500	1500	1500	
Max. operating frequency (cycle/min)	80	70	45	25	10	
Spring force (N)	Extended	1.96	4.22	6.86	8.34	8.83
	Retracted	4.22	6.86	15.98	20.50	20.01
Operating temperature range (°C)	5 to 60					

\* The shock absorber service life is different from that of the MY2H/HT cylinder depending on operating conditions. Refer to the RB Series Specific Product Precautions for the replacement period.

# MY2H/HT Series

## Theoretical Output

Bore size (mm)	Piston area (mm <sup>2</sup> )	Operating pressure (MPa)						
		0.2	0.3	0.4	0.5	0.6	0.7	0.8
16	200	40	60	80	100	120	140	160
25	490	98	147	196	245	294	343	392
40	1256	251	377	502	628	754	879	1005

Note) Theoretical output (N) = Pressure (MPa) x Piston area (mm<sup>2</sup>)

## Replacement Parts

### Drive Unit (Cylinder) Replacement Part No.

Bore size (mm)	Model	
	MY2H	MY2HT
16	MY2BH16G-Stroke	
25	MY2BH25□G-Stroke	
40	MY2BH40□G-Stroke	

Enter a symbol for port thread type inside □.

Note) Order auto switches separately.

## Option

### Stroke Adjustment Unit Part No.

**MY 2H - A 25 L2 - 6N**

#### Guide type

2H	MY2H16
2H	MY2H25
2H	MY2H40
2HT	MY2HT16
2HT	MY2HT25
2HT	MY2HT40

#### Stroke adjustment unit

Bore size	
16	16 mm
25	25 mm
40	40 mm

Symbol	Stroke adjustment unit	Mounting position
L1	L unit	Left
L2		Right
H1	H unit	Left
H2		Right

Note) Refer to page 1389 for details about adjustment range.

#### Intermediate fixing spacer

Nil	Without spacer
6□	Short spacer
7□	Long spacer

#### Spacer delivery type

Nil	Unit installed
N	Spacer only

\* Spacers are used to fix the stroke adjustment unit at an intermediate stroke position.

\* Spacers are shipped for a set of two.

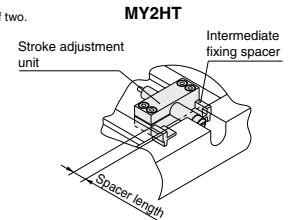
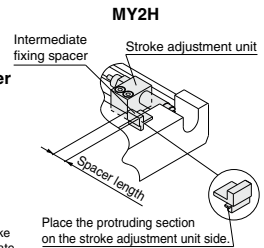

\* When ordering the intermediate fixing spacer for the stroke adjustment unit, the intermediate fixing spacer is shipped together.

## Component Parts

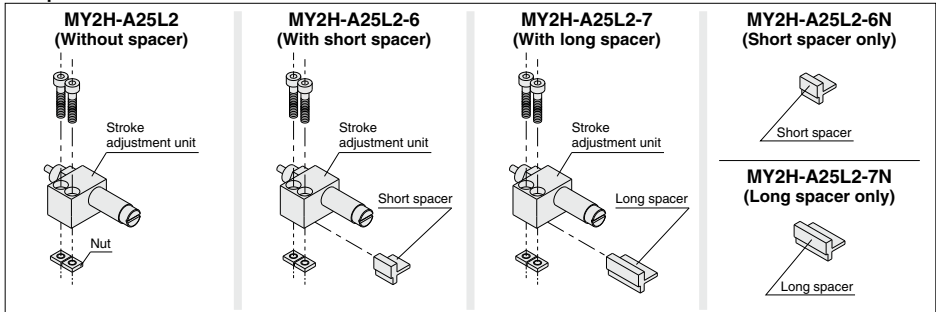

\* Nuts are equipped on the cylinder body.

## Weight

Model	Bore size (mm)	Basic weight	Additional weight per each 50 mm of stroke	Weight of moving parts	Stroke adjustment unit weight (per unit)	
					L unit weight	H unit weight
MY2H	16	0.86	0.22	0.21	0.03	0.04
	25	2.35	0.42	0.64	0.06	0.09
	40	6.79	0.76	2.20	0.16	0.22
MY2HT	16	1.27	0.31	0.33	0.04	0.08
	25	3.70	0.61	1.20	0.10	0.18
	40	10.05	1.13	3.35	0.27	0.46

Calculation: (Example) MY2H25G-300L

- Basic weight..... 2.35 kg
- Cylinder stroke..... 300 stroke
- Additional weight..... 0.42/50 stroke
- 2.35 + 0.42 x 300/50 + 0.06 x 2 ≒ 4.99 kg
- Weight of L unit..... 0.06 kg



MY1B

MY1H

MY1B

MY1M

MY1C

MY1H

MY1  
HT

MY1  
W

MY2C

MY2  
H/HT

MY3A  
MY3B

MY3M

D-

-X

Technical  
Data

# MY2H/HT Series

## Construction

### Single axis type: MY2H

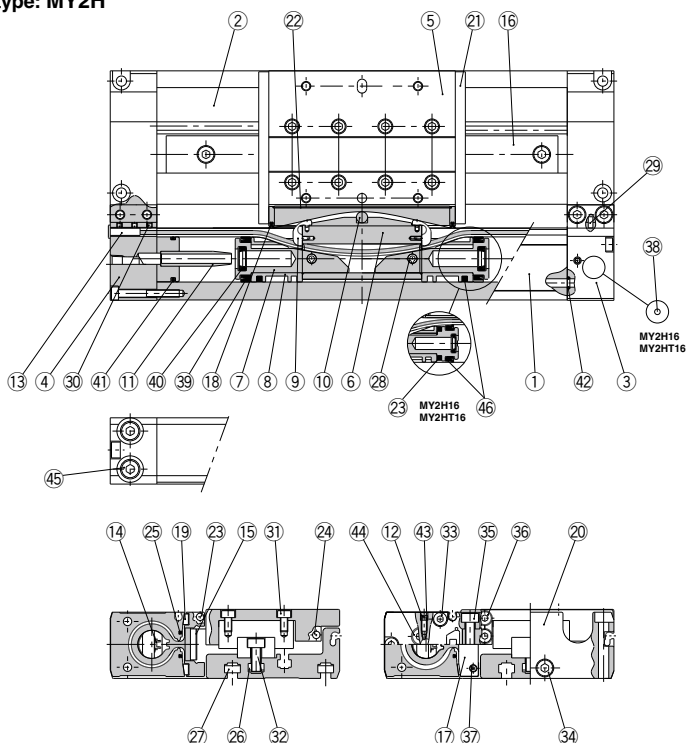

### Component Parts

No.	Description	Material	Note
1	Cylinder tube	Aluminum alloy	Hard anodized
2	Body	Aluminum alloy	Anodized
3	Head cover WR	Aluminum alloy	Hard anodized
4	Head cover WL	Aluminum alloy	Hard anodized
5	Slide table	Aluminum alloy	Hard anodized
6	Piston yoke	Aluminum alloy	Hard anodized
7	Piston	Aluminum alloy	Chromated
8	Wear ring	Special resin	
9	Belt separator	Special resin	
10	Parallel pin	Stainless steel	
11	Cushion ring	Aluminum alloy	Anodized
12	Cushion needle	Rolled steel	Nickel plated
13	Wear clamp	Special resin	
16	Guide	—	
17	End cover	Aluminum alloy	Hard anodized
19	Bearing	Special resin	
20	End plate	Aluminum alloy	Hard anodized
21	Stopper	Carbon steel	Nickel plated after quenching
22	Top cover	Stainless steel	

No.	Description	Material	Note
23	Magnet	—	
24	Magnet	—	
25	Seal magnet	Rubber magnet	
26	Square nut	Carbon steel	Chromated
27	Square nut	Carbon steel	Chromated
28	Spring pin	Carbon tool steel	
29	Parallel pin	Stainless steel	
30	Hexagon socket set screw	Chrome molybdenum steel	Black zinc chromated
31	Hexagon socket head cap screw	Chrome molybdenum steel	Chromated
32	Hexagon socket head cap screw	Chrome molybdenum steel	Chromated
33	Hexagon socket head cap screw	Chrome molybdenum steel	Chromated
34	Hexagon socket head cap screw	Chrome molybdenum steel	Chromated
35	Hexagon socket head cap screw	Chrome molybdenum steel	Chromated
36	Hexagon socket head cap screw	Chrome molybdenum steel	Chromated
37	Hexagon socket head cap screw	Chrome molybdenum steel	Chromated
38	Steel ball	Spring steel	Nickel plated
44	Hexagon socket head (taper) plug	Carbon steel	Chromated
45	Hexagon socket head (taper) plug	Carbon steel	Chromated
46	Lubretainer	Special resin	

Double axis type: MY2HT

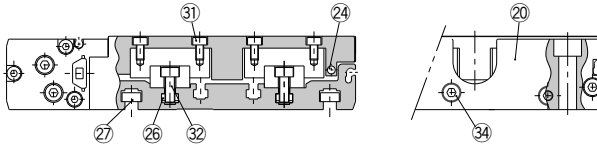
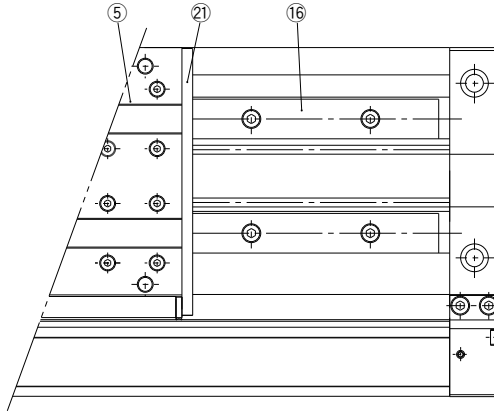

Replacement Parts: Seal Kit

No.	Description	Qty.	MY2H16G/MY2HT16G	MY2H25G/MY2HT25G	MY2H40G/MY2HT40G
14	Seal belt	1	MY16-16C-[Stroke]	MY25-16C-[Stroke]	MY40-16C-[Stroke]
15	Dust seal band	1	MY2H16-16B-[Stroke]	MY2H25-16B-[Stroke]	MY2H40-16B-[Stroke]
43	O-ring	2	KA00309 (ø4 x ø1.8 x ø1.1)	KA00309 (ø4 x ø1.8 x ø1.1)	KA00320 (ø7.15 x ø3.75 x ø1.7)
18	Scraper	2			
39	Piston seal	2			
40	Cushion seal	2			
41	Tube gasket	2	MY2B16-PS	MY2B25-PS	MY2B40-PS
42	O-ring	4			

\* Seal kit includes 18, 39, 40, 41 and 42. Order the seal kit based on each bore size.

\* Seal kit includes a grease pack (10 g).  
When 18 and 19 are shipped as single units, a grease pack (20 g) is included.  
Order with the following part number when only the grease pack is needed.  
Grease pack part number:GR-S-010 (10 g), GR-S-020 (20 g)

- MY1B
- MY1H
- MY1B
- MY1M
- MY1C
- MY1H
- MY1 HT
- MY1 □W
- MY2C
- MY2 H/HT**
- MY3A
- MY3B
- MY3M

- D-□
- X□
- Technical Data

# MY2H/HT Series

Single Axis Type:  $\varnothing 16$ ,  $\varnothing 25$ ,  $\varnothing 40$

Refer to page 1402 regarding port variations.

MY2H Bore size G – Stroke

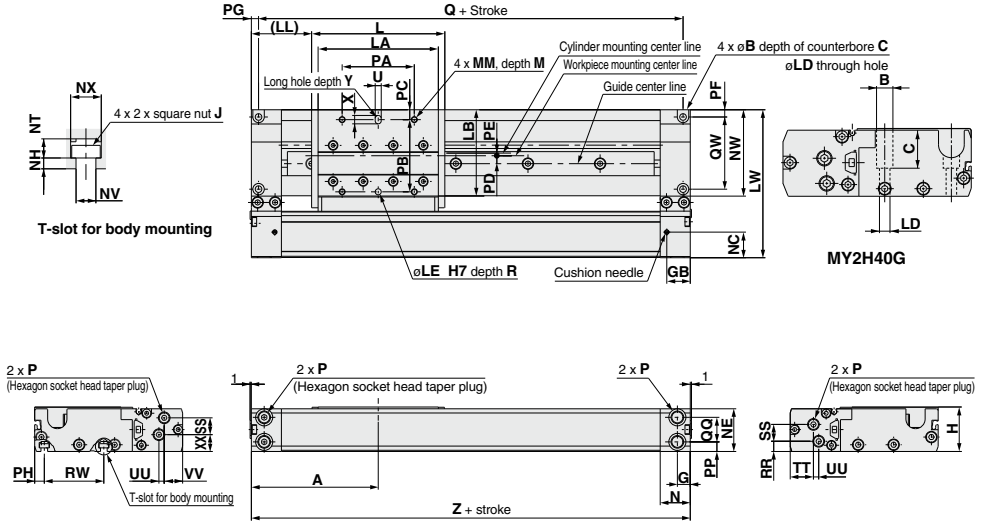

Model	A	B	C	G	GB	H	L	J	LA	LB	LD	LE	(LL)	LW	M	MM	N	NC	NE	NH	NT	NV	NW	NX	P
MY2H16G	80	6.5	3.3	8.5	17	28	80	M3 x 0.5	70	50.4	3.4	4	40	83	7	M4 x 0.7	20	14	27	2	3.5	3.4	48.2	5.8	M5 x 0.8
MY2H25G	105	9.5	5.4	10.7	19.5	37	110.8	M5 x 0.8	100	71.7	5.5	5	49.6	123	9	M5 x 0.8	25	21.3	35.5	3	5.3	5.5	71.8	8.5	1/8
MY2H40G	165	14	32.5	15.5	31.5	58	180	M6 x 1	158	80.3	9	6	75	161	13	M6 x 1	40	32.4	56.5	4	6.5	6.6	82.1	10.5	1/4

Model	PA	PB	PC	PD	PE	PF	PG	PH	PP	Q	QQ	QW	R	RR	RW	SS	TT	U	UU	VV	X	XX	Y	Z
MY2H16G	40	40	7.2	2.8	3.7	3.5	4	5.1	5.3	152	16.4	40	5	5.3	40	9.7	12.5	4	3	10.5	6	12	5	160
MY2H25G	60	60	8.2	6.6	2.7	5.5	6	7.5	8	198	20.4	60	5	8.5	50	14	19.3	5	4.4	15.3	7.5	14	5	210
MY2H40G	100	70	5.5	8.5	5	17	9	9.5	16	312	25.5	57	8	11	53.5	21.5	35.4	6	2	29	9	23	8	330

\*P\* indicates cylinder supply ports. \* The plug for "P" MY2H16G is a hexagon socket head plug.

**Stroke adjustment unit**

**Low load shock absorber**

**MY2H** Bore size **G** – Stroke **L**

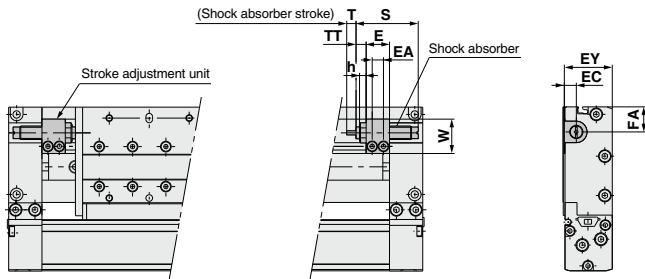

Applicable cylinder	E	EA	EC	EY	FA	h	S	T	TT	W	Shock absorber model
MY2H16	14.4	7	6	27	12.5	4	40.8	6	5.6 (Max. 11.2)	16.5	RB0806
MY2H25	17.5	8.5	9	36	19.3	5	46.7	7	7.1 (Max. 18.6)	25.8	RB1007
MY2H40	25	13	13	57	17	6	67.3	12	10 (Max. 26)	38	RB1412

**High load shock absorber**

**MY2H** Bore size **G** – Stroke **H**

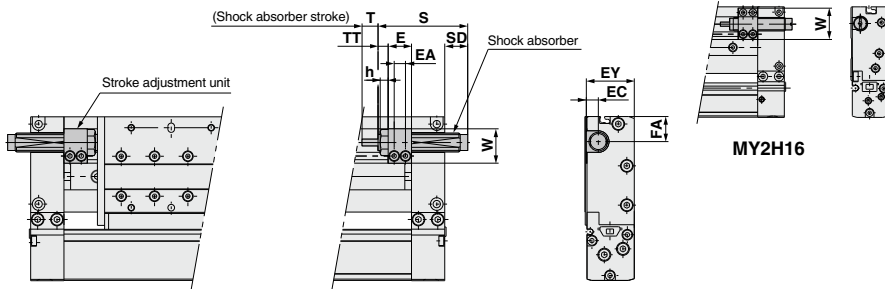

Applicable cylinder	E	EA	EC	EY	FA	h	S	SD	T	TT	W	Shock absorber model
MY2H16	14.4	7	6	27	12.5	—	46.7	6.7	7	5.6 (Max. 11.2)	23.5	RB1007
MY2H25	17.5	8.5	9	36	19.3	6	67.3	17.7	12	7.1 (Max. 18.6)	25.8	RB1412
MY2H40	25	13	13	57	17	6	73.2	—	15	10 (Max. 26)	38	RB2015

MY1B

MY1H

MY1B

MY1M

MY1C

MY1H

MY1

HT

MY1

□W

MY2C

MY2

H/HT

MY3A

MY3B

MY3M

D-□

-X□

Technical  
Data

# MY2H/HT Series

Double Axis Type:  $\varnothing 16$ ,  $\varnothing 25$ ,  $\varnothing 40$

Refer to page 1402 regarding port variations.

MY2HT Bore size G - Stroke

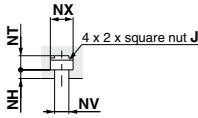
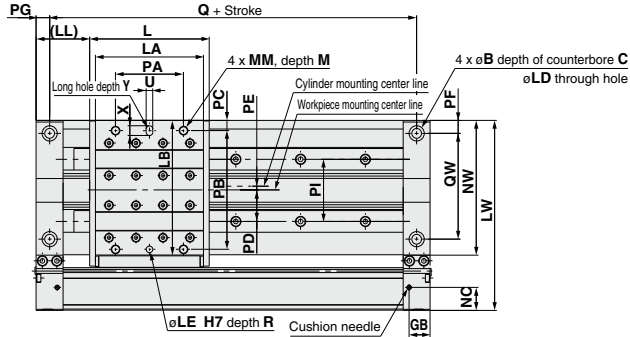

T-slot for body mounting

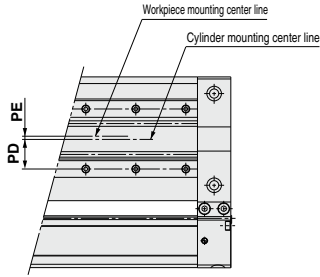

MY2HT40G

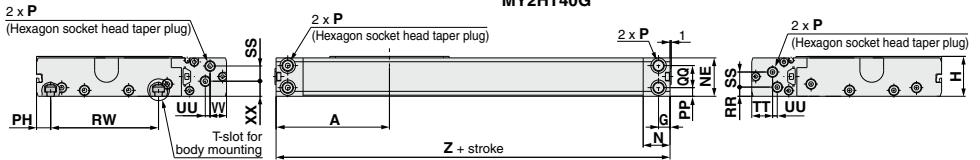

Model	A	B	C	G	GB	H	L	J	LA	LB	LD	LE	(LL)	LW	M	MM	N	NC	NE	NH	NT
MY2HT16G	80	9.5	5.4	8.5	17	28	80	M4 x 0.7	70	87.4	5.5	5	40	120	9	M5 x 0.8	20	14	27	3	4.7
MY2HT25G	105	14	8.6	10.7	19.5	37	110.8	M6 x 1	100	124.7	9	6	49.6	176	12	M8 x 1.25	25	21.3	35.5	4	6.5
MY2HT40G	165	17.5	10.8	15.5	31.5	58	180	M8 x 1.25	158	148.3	11	8	75	229	16	M10 x 1.5	40	32.4	56.5	5	9

Model	NV	NW	NX	P	PA	PB	PC	PD	PE	PF	PG	PH	PI	PP	Q	QQ	QW	R	RR	RW	SS	TT
MY2HT16G	4.5	85.2	7.3	M5 x 0.8	44	80	4	23	1	10	10	10.2	41	5.3	140	16.4	66	5	5.3	69	9.7	12.5
MY2HT25G	6.6	124.8	10.5	1/8	63	110	9.4	29.2	3.4	12	12.5	13	57.6	8	185	20.4	98	8	8.5	100	14	19.3
MY2HT40G	9	150.1	14	1/4	113	132	8.5	35.5	0.5	20	20	18.5	72	16	290	25.5	110	12	11	116	21.5	35.4

Model	U	UU	VV	X	XX	Y	Z
MY2HT16G	5	3	10.5	7	12	5	160
MY2HT25G	6	4.4	15.3	9	14	8	210
MY2HT40G	8	2	29	12	23	12	330

"P" indicates cylinder supply ports. \* The plug for "P" MY2HT16G is a hexagon socket head plug.

**Stroke adjustment unit**

**Low load shock absorber**

MY2HT **Bore size** G – **Stroke** L

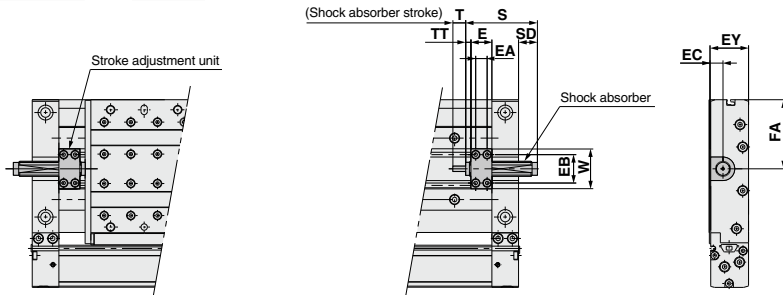

Applicable cylinder	E	EA	EB	EC	EY	FA	S	SD	T	TT	W	Shock absorber model
MY2HT16	14.4	7	21	8	27	46.5	46.7	6.7	7	5.6 (Max. 11.2)	28.6	RB1007
MY2HT25	19.7	10.7	26.6	11.2	36	64.8	67.3	17.7	12	4.9 (Max. 16.4)	37.2	RB1412
MY2HT40	29.1	15.1	37	17.2	57	74.5	73.2	—	15	5.9 (Max. 21.9)	51.6	RB2015

**High load shock absorber**

MY2HT **Bore size** G – **Stroke** H

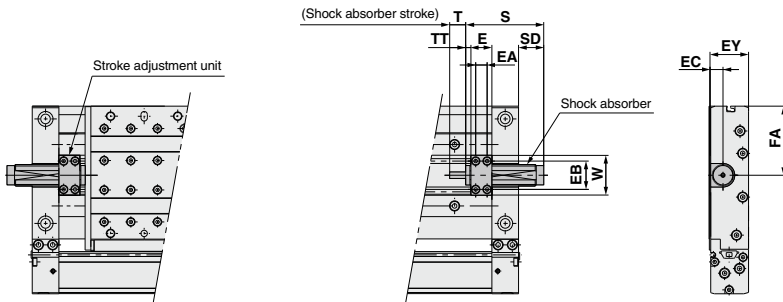

Applicable cylinder	E	EA	EB	EC	EY	FA	S	SD	T	TT	W	Shock absorber model
MY2HT16	14.4	7	21	8	27	46.5	67.3	27.3	12	5.6 (Max. 11.2)	28.6	RB1412
MY2HT25	19.7	10.7	26.6	11.2	36	64.8	73.2	23.6	15	4.9 (Max. 16.4)	37.2	RB2015
MY2HT40	29.1	15.1	37	17.2	57	74.5	99	24	25	5.9 (Max. 21.9)	51.6	RB2725

MY1B

MY1H

MY1B

MY1M

MY1C

MY1H

MY1 HT

MY1 □W

MY2C

MY2 H/HT

MY3A

MY3B

MY3M

D-□

-X□

Technical Data

# MY2 Series Auto Switch Mounting

## Proper Auto Switch Mounting Position (Detection at stroke end)

Note) The operating range is a standard including hysteresis, and is not guaranteed. There may be large variations depending on the surrounding environment (variations on the order of  $\pm 30\%$ ).

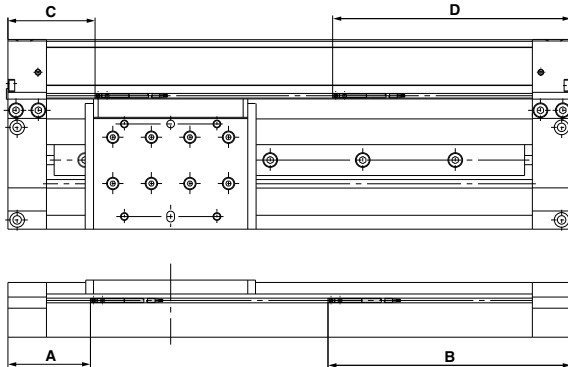

### D-A9□, D-A9□V

Series model	A	B	Operating range
MY2C16	44	116	11
MY2H16	46	114	
MY2HT16	70	90	
MY2C/H/HT25	54	156	
MY2C/H/HT40	85	245	

Series model	C	D	Operating range
MY2C/H/HT16	27.6	132.4	6.5
MY2C/H/HT25	69	141	11
MY2C/H/HT40	90.2	239.8	

### D-M9□, D-M9□V, D-M9□W, D-M9□WV, D-M9□A, D-M9□AV

Series model	A	B	Operating range
MY2C16	48	112	8.5
MY2H16	50	110	
MY2HT16	74	86	
MY2C/H/HT25	58	152	
MY2C/H/HT40	89	241	

Series model	C	D	Operating range
MY2C/H/HT16	31.6	128.4	4
MY2C/H/HT25	73	137	8.5
MY2C/H/HT40	94.2	235.8	

\* Adjust the auto switch after confirming the operating conditions in the actual setting.

Besides the models listed in How to Order, the following auto switches are applicable.

- \* For solid state auto switches, auto switches with a pre-wired connector are also available. Refer to pages 1648 and 1649 for details.
- \* Normally closed (NC = b contact) solid state auto switches (D-F9G/F9H types) are also available. Refer to page 1593 for details.



# MY2 Series

## Made to Order: Individual Specifications

Please contact SMC for detailed dimensions, specifications and lead times.



### 1 Helical Insert Thread Specifications

Symbol  
-X168

Helical insert thread is used for the slide table mounting thread, the thread size is the same as the standard model.

MY2  Bore size - Stroke - Auto switch Suffix -X168

Series: Bore size

C	Cam follower guide type	16	25	40
H	Linear guide type (Single axis)	●	●	●
HT	Linear guide type (Double axis)	●	●	●

Example) MY2H40G-300L-A93-X168

- MY1B
- MY1H
- MY1B
- MY1M
- MY1C
- MY1H
- MY1 HT
- MY1 W
- MY2C
- MY2 H/HT
- MY3A
- MY3B
- MY3M

- D-
- X
- Technical Data



# MY2 Series Specific Product Precautions 1

Be sure to read this before handling the products. Refer to back page 50 for Safety Instructions and pages 3 to 12 for Actuator and Auto Switch Precautions.

## Selection

### ⚠ Caution

#### 1. When using a cylinder with long strokes, implement an intermediate support.

When using a cylinder with long strokes, implement an intermediate support to prevent the tube from sagging and being deflected by vibration or an external load.

Refer to the Guide for Side Support Application (MY2C series) on page 1386.

#### 2. For intermediate stops, use a dual-side pressure control circuit.

Since the mechanically jointed rodless cylinders have a unique seal structure, slight external leakage may occur. Controlling intermediate stops with a 3 position valve cannot hold the stopping position of the slide table (slider). The speed at the restarting state also may not be controllable. Use the dual-side pressure control circuit with a PAB-connected 3 position valve for intermediate stops.

#### 3. Constant speed

Since the mechanically jointed rodless cylinders have a unique seal structure, a slight speed change may occur. For applications that require constant speed, select an applicable equipment for the level of demand.

#### 4. Load factor of 0.5 or less

When the load factor is high against the cylinder output, it may adversely affect the cylinder (condensation, etc.) and cause malfunctions. Select a cylinder to make the load factor less than 0.5. (Mainly when using an external guide)

#### 5. Cautions on less frequent operation

When the cylinder is used extremely infrequently, operation may be interrupted in order for anchoring and a change lubrication to be performed or service life may be reduced.

#### 6. Consider uncalculated loads such as piping, cableveyor, etc., when selecting a load moment

Calculation does not include the external acting force of piping, cableveyor, etc. Select load factors taking into account the external acting force of piping, cableveyor, etc.

#### 7. Accuracy

The mechanical jointed rodless cylinder does not guarantee traveling parallelism. When accuracy in traveling parallelism and a middle position of stroke is required, please consult with SMC.

## Mounting

### ⚠ Caution

#### 1. Do not apply a strong impact or moment on the slide table (slider).

Since the slide table (slider) is supported by precision bearings, do not subject it to strong impact or excessive moment when mounting workpieces.

#### 2. When connecting to a load which has an external guide mechanism, use a discrepancy absorption mechanism.

A mechanically jointed rodless cylinder can be used with a direct load within the allowable range for each guide type, however, align carefully when connecting to a load with an external guide mechanism.

#### 3. Attaching and detaching the actuator unit (cylinder)

When detaching the actuator unit, remove the four cylinder holding bolts and take the actuator unit off the guide unit. When attaching the actuator unit, insert the slider into the slide table on the guide unit, and tighten the four holding bolts equally. Since loosened holding bolts may cause damage or malfunction, be sure to secure them tightly.

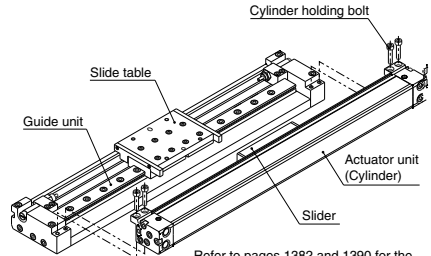

Refer to pages 1382 and 1390 for the actuator unit (cylinder) replacement part numbers.



# MY2 Series Specific Product Precautions 2

Be sure to read this before handling the products. Refer to back page 50 for Safety Instructions and pages 3 to 12 for Actuator and Auto Switch Precautions.

## Mounting

### Caution

#### 4. Auto Switch Mounting

The MY2 series can be equipped with auto switches on the top of the actuator unit (cylinder) and on the side of the guide unit, but use caution in the following cases.

**<Mounting an auto switch on the top of the actuator unit (cylinder)>**

For auto switches with perpendicular electrical entry, the lead wire may interfere with the workpiece depending on the workpiece mounting type and shape.

Be sure to allow a clearance in order to keep the lead wire from interfering with the workpiece.

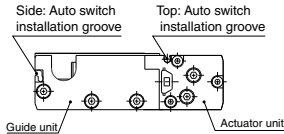

#### 5. Workpiece Mounting

When mounting a magnetic workpiece, the auto switch may stop working due to a loss of magnetic force in the cylinder depending on the mounting position. Allow a clearance of 5 mm or more between the auto switch and workpiece.

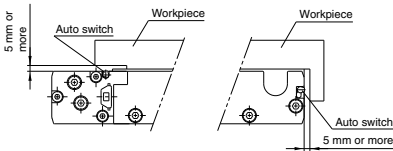

#### 6. Body Mounting

When mounting MY2H40G with stroke adjustment unit from the top, move the stroke adjustment unit and secure the body with the end plate mounting holes. After mounting, return the stroke adjustment unit to the stroke end and secure it again.

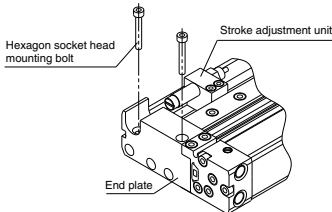

#### 7. Do not generate negative pressure in the cylinder tube.

Take precautions under operating conditions in which negative pressure is generated inside the cylinder by external forces or inertial forces. Air leakage may occur due to separation of the seal belt. Do not generate negative pressure in the cylinder by forcibly moving it with an external force during the trial operation or dropping it with self-weight under the non-pressure state, etc. When the negative pressure is generated, slowly move the cylinder by hand and move the stroke back and forth. (When using with a stroke adjustment unit, please either remove the unit or adjust the stroke to the full stroke.) After doing so, if air leakage still occurs, please consult with SMC.

#### 8. Do not mount cylinders as they are twisted.

When mounting, be sure for a cylinder tube not to be twisted. The flatness of the mounting surface is not appropriate, the cylinder tube is twisted, which may cause air leakage due to the detachment of a seal belt, damage a dust seal band, and cause malfunctions.

#### 9. Do not mount a slide table on the fixed equipment surface.

It may cause damage or malfunctions since an excessive load is applied to the bearing.

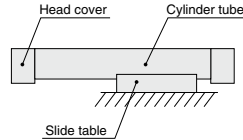

Mounting with a slide table (slider)

#### 10. Consult with SMC when mounting in a cantilevered way.

Since the cylinder body deflects, it may cause malfunctions. Please consult with SMC when using it this way.

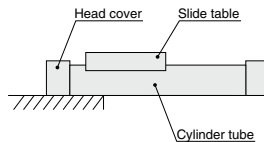

Mounting in a cantilevered way

#### 11. Fixed parts of the cylinder on both ends must have at least 5 mm of contact between where the bottom of the cylinder tube and the equipment surface.

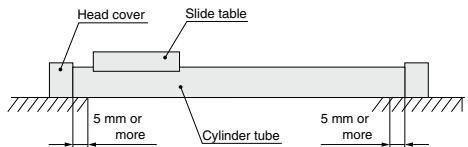

#### 12. Consider uncalculated loads such as piping, cableveyor, etc., when selecting a load moment

Calculation does not include the external acting force of piping, cableveyor, etc. Select load factors taking into account the external acting force of piping, cableveyor, etc.

#### 13. Do not unnecessarily alter the guide adjustment setting.

The adjustment of the guide is preset and does not require readjustment under normal operating conditions. Therefore, do not unnecessarily alter the guide adjustment setting.

MY1B

MY1H

MY1B

MY1M

MY1C

MY1H

MY1 HT

MY1 □ W

MY2C

MY2 H/HT

MY3A

MY3B

MY3M

D-□

-X□

Technical Data



# MY2 Series Specific Product Precautions 3

Be sure to read this before handling the products. Refer to back page 50 for Safety Instructions and pages 3 to 12 for Actuator and Auto Switch Precautions.

## Operating Environment

### Warning

1. Do not use in environments where the cylinder will come in contact with coolants, cutting oil, water drops, adhesive foreign particles, dust, etc., and do not operate the cylinder with compressed air that contains drainage and foreign matter.

Foreign matter or liquids on the cylinder interior or exterior can wash away the lubricating grease, which can lead to deterioration and damage of the dust seal band and seal materials, causing a danger of malfunction.

When operating in locations with exposure to water, oil drops, or dust, provide protection such as a cover to prevent direct contact with the cylinder, or mount the dust seal band surface downwards, and operate it with clean compressed air.

2. Carry out cleaning and grease application suitable for the operating environment.

Carry out cleaning regularly when using in an operating environment in which the product is likely to get dirty.

After cleaning, be sure to apply grease to the top side of the cylinder tube and the rotating part of the dust seal band. Apply grease to these parts regularly even if not after cleaning. Please consult with SMC for the cleaning of the slide table (slider) interior and grease application.

## Service Life and Replacement Period of Shock Absorber

### Caution

1. Allowable operating cycle under the specifications set in this catalog is shown below.

1.2 million times RB08□□

2 million times RB10□□ to RB2725

Note) Specified service life (suitable replacement period) is the value at room temperature (20 to 25 °C). The period may vary depending on the temperature and other conditions. In some cases the absorber may need to be replaced before the allowable operating cycle above.

## Centralized Piping Port Variations

### Caution

Head cover piping connection can be freely selected to best suit different piping conditions.

