

5 Port Solenoid Valve

VQC4000/5000 Series

Metal Seal

Rubber Seal

Compact and large flow capacity

VQC4000 Possible to drive cylinders up to $\varnothing 160$

VQC5000 Possible to drive cylinders up to $\varnothing 180$ * When the average speed is 200 mm/s. Refer to page 608 for actual conditions.

VQC4000: 25 mm pitch

$C[dm^3/(s\text{-bar})]: 7.3^*$

VQC5000: 41 mm pitch

$C[dm^3/(s\text{-bar})]: 17^*$

* 2-position single, rubber seal: 4/2 → 5/3 (A/B → R1/R2)

Extensive range of protocols available

 EtherCAT 
 EtherNet/IP  DeviceNet
 CC-Link  IO-Link

 and  are compatible with wireless systems.

Connector type manifold

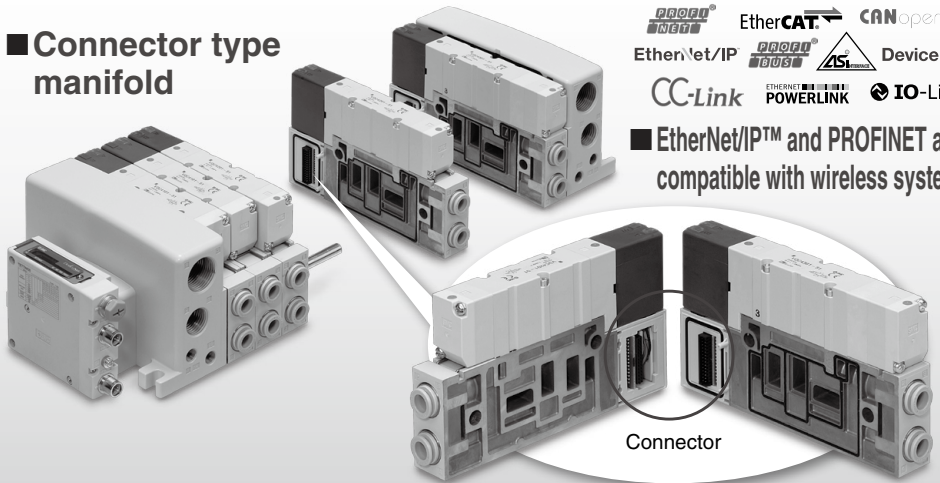

Connector

Power saving

	Power consumption [W]	Maximum operating pressure [MPa]
VQC	0.4 (0.95)	1.0
Current product	0.5 (1.0)	0.7

* Low wattage type (): Standard

Long service life **100 million cycles** (Metal seal)
 * According to SMC life test conditions

Enclosure IP67 compliant

* Except F and P kits

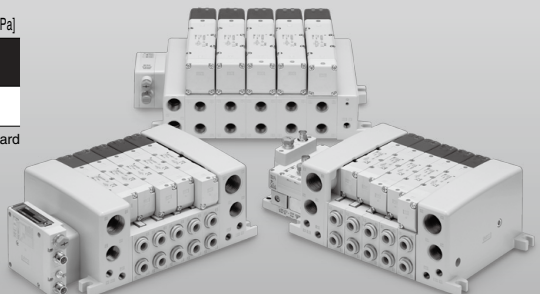

SV
SYJ
SZ
VF
VP4
VQ 1/2
VQ 4/5
VQC 1/2
VQC 4/5
VQZ
SQ
VFS
VFR
VQ7

■ Compact and large flow

Model (Series)	Valve pitch [mm]	Flow rate characteristics ^{Note)}					
		Metal seal			Rubber seal		
		C [dm ³ /(s·bar)]	b	Cv	C [dm ³ /(s·bar)]	b	Cv
VQC4000	25	6.9	0.17	1.7	7.3	0.38	2.0
VQC5000	41	14	0.18	3.4	17	0.31	4.7

Note) Flow rate characteristics: 2-position single, 4/2 → 5/3 (A/B → R1/R2)

■ Applicable to EX600 (Input/Output) serial transmission system (Fieldbus system)

■ Compatible Protocols

CC-Link **V2**

DeviceNet

PROFINET

EtherNet/IP

EtherCAT

PROFINET

■ EtherNet/IP™ and PROFINET are compatible with wireless systems.

Reduction in wiring time with SPEEDCON (Phoenix Contact). Just insert and make 1/2 rotation!

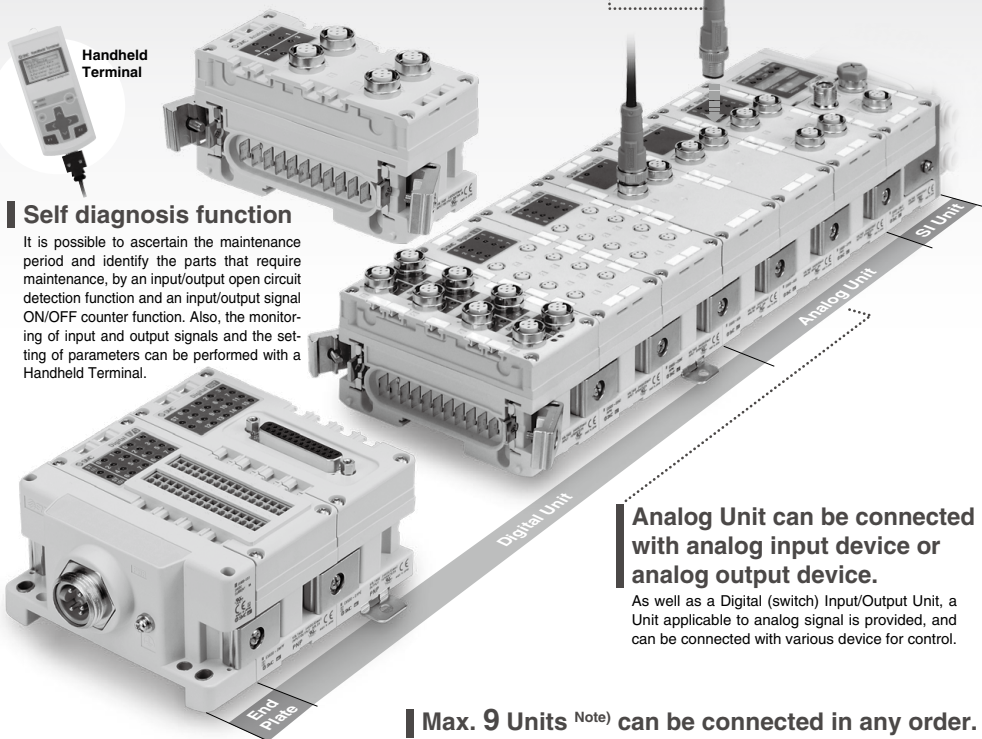

Self diagnosis function

It is possible to ascertain the maintenance period and identify the parts that require maintenance, by an input/output open circuit detection function and an input/output signal ON/OFF counter function. Also, the monitoring of input and output signals and the setting of parameters can be performed with a Handheld Terminal.

Analog Unit can be connected with analog input device or analog output device.

As well as a Digital (switch) Input/Output Unit, a Unit applicable to analog signal is provided, and can be connected with various device for control.

■ **Max. 9 Units** ^{Note)} can be connected in any order.

The Input Unit to connect input device such as an auto switch, pressure switch and flow switch, and the Output Unit to connect output device such as a solenoid valve, relay and indicator light can be connected in any order.

Note) Except SI Unit

■ EX260 (Output device for driving 5 port solenoid valves)

Compatible Protocols



DeviceNet

EtherNet/IP



Compact
28 mm



Number of outputs	Each 32/16 digital output type available in the series. (Only the 32 point digital output type is available for IO-Link compatible units.)
Output polarity	Each negative common (PNP)/positive common (NPN) type available in the series. (Only the negative common (PNP) type is available for Ethernet POWERLINK and IO-Link compatible units.)
Enclosure	IP67 (For Units with D-sub connector, and when connected with S0700 manifolds, it is IP40.)
Internal terminating resistor	ON/OFF switching is possible with an internal terminating resistor for communication. (Only for Units compatible with M12 PROFIBUS DP, CC-Link communication connectors)

■ A wide variety of prepackaged wiring configurations

S Kit (Serial transmission) IP67 enclosure compliant	F Kit (D-sub connector) IP40 enclosure compliant	P Kit (Flat ribbon cable) IP40 enclosure compliant	T Kit (Terminal block box) IP67 enclosure compliant	L Kit (Lead wire) IP67 enclosure compliant	M Kit (Circular connector) IP67 enclosure compliant
-----------------------------------------------------------------------	-------------------------------------------------------------------	---------------------------------------------------------------------	----------------------------------------------------------------------	-------------------------------------------------------------	----------------------------------------------------------------------

- Our six standard wiring packages bring a world of ease to wiring and maintenance work, while the protective enclosures of four of them conform to IP67 standards.
- The S kit is compatible with a combined I/O Unit. (Not applicable to Gateway Unit)

■ Connector type manifold

- The use of multi-pin connectors to replace wiring inside manifold blocks provides flexibility when adding stations or changing manifold configuration.
- All kits use multi-pin connectors, so switching from the F kit (D-sub connector) to the S kit (serial transmission) can be done simply by changing the kit section.

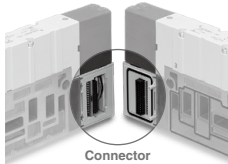

Connector

(Refer to the connector wiring diagram.)
Printed circuit board patterns between connectors are shifted at every station. This allows for viable connections to take place without necessarily specifying whether the manifold station is double, single, or mixed wiring.

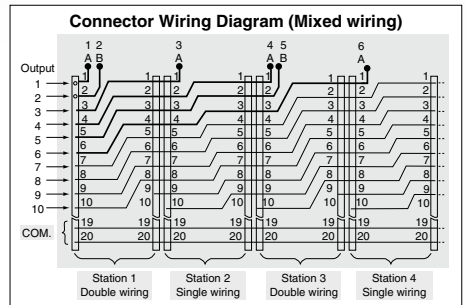

■ Connector entry direction can be changed with a single push. (F/P kit)

The connector entry direction can be changed from the top to the side by simply pressing the manual release button.

It is not necessary to use the manual release button when switching from the side to the top.

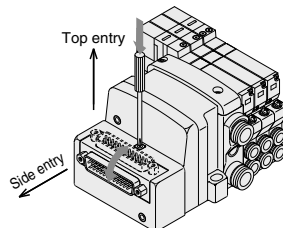

VQC4000/5000 Series

Sub-plate/Base Mounted: Variations



Sub-plate



Base mounted

Sonic conductance C [dm ³ /(s·bar)]		S kit					
		Serial transmission					
		Gateway-type	Integrated-type (I/O)			Integrated-type (for output)	
(Values: CYL → EXH 4/2 → 5/3)		EX500	EX600	EX245	EX250	EX260	EX126
Single/Double	3-position (Closed center)	Compatible protocol · EtherNet/IP™ · PROFINET · PROFIBUS DP · DeviceNet™	Compatible protocol · PROFINET* · EtherCAT · EtherNet/IP™* · PROFIBUS DP · DeviceNet™ · CC-Link * Compatible with wireless systems	Compatible protocol · PROFINET	Compatible protocol · EtherNet/IP™ · PROFIBUS DP · DeviceNet™ · AS-Interface · CANopen	Compatible protocol · PROFINET · EtherCAT · EtherNet/IP™ · PROFIBUS DP · DeviceNet™ · CC-Link · Ethernet POWERLINK · IO-Link	Compatible protocol · CC-Link
		IP67 compliant	IP67 compliant	IP65 compliant	IP67 compliant	IP40 compliant IP67 compliant	IP67 compliant

	Seal	Sonic conductance		Sonic conductance						
		Value	Value	EX500	EX600	EX245	EX250	EX260	EX126	
Sub-plate	Metal seal	VQC4□00	6.9	6.3						
		VQC4□01	7.3	6.4						
	Rubber seal	VQC5□00	14	11						
		VQC5□01	17	13						
Base Mounted	Metal seal	VQC4□00	6.9	6.3	●	●	●	●	●	●
		VQC4□01	7.3	6.4	Page 614	Page 614	Page 614	Page 614	Page 614	Page 614
	Rubber seal	VQC5□00	14	11	●	●	—	●	●	●
		VQC5□01	17	13	Page 652	Page 652	—	Page 652	Page 652	Page 652

Manifold options are the same as those for the VQ4000/5000 series. Refer to page 445.

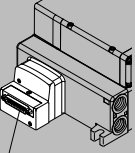
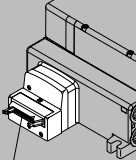
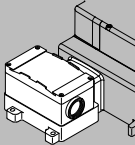
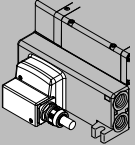
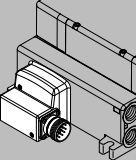
F Kit	P Kit	T Kit	L Kit	M Kit	Port size	
D-sub connector	Flat ribbon cable	Terminal block box	Electrical entry	Circular connector	SUP EXH port	Cylinder port
<p>D-sub connector (Compatible with D-sub connector that complies with MIL standard.)</p>  <p>25 pins IP40 compliant</p>	<p>Flat ribbon cable (Compatible with flat ribbon cable connector that complies with MIL standard.)</p>  <p>26 pins/20 pins IP40 compliant</p>	<p>Terminal block box (Terminal blocks) Terminals are concentrated in compact clusters within the terminal block box.</p>  <p>IP67 compliant</p>	<p>Lead wire (IP67 enclosure with use of multiple wire cable with sheath and waterproof connector)</p>  <p>IP67 compliant</p>	<p>Circular connector (IP67 enclosure with use of waterproof multiple connector)</p>  <p>IP67 compliant</p>	<p>1, 3 (P, R)</p>	<p>2, 4 (A, B)</p>
—	—	—	—	—		
<p>● Page 626</p>	<p>● Page 628</p>	<p>● Page 630</p>	<p>● Page 632</p>	<p>● Page 634</p>	<p><SUP port> 1/2 (Rc, NPT, NPTF, G)</p>	<p>C6 (for ø6) C8 (for ø8) C10 (for ø10) C12 (for ø12) N7 (ø1/4") N9 (ø5/16") N11 (ø3/8")</p>
<p>● Page 664</p>	<p>● Page 666</p>	<p>● Page 668</p>	<p>● Page 670</p>	<p>● Page 672</p>	<p><EXH port> 3/4 (Rc, NPT, NPTF, G)</p>	<p>1/4 3/8 1/4 (Bottom ported) (Rc, NPT, NPTF, G)</p>
<p>● Page 664</p>	<p>● Page 666</p>	<p>● Page 668</p>	<p>● Page 670</p>	<p>● Page 672</p>	<p><SUP port> D side 1/2 (Rc, NPT, NPTF, G) U side 3/8 (Rc, NPT, NPTF, G)</p>	<p>3/8 1/2 1/2 (Bottom ported) (Rc, NPT, NPTF, G)</p>
<p>● Page 664</p>	<p>● Page 666</p>	<p>● Page 668</p>	<p>● Page 670</p>	<p>● Page 672</p>	<p><EXH port> D side 1/2 (Rc, NPT, NPTF, G) U side 3/8 (Rc, NPT, NPTF, G)</p>	<p>3/8 1/2 1/2 (Bottom ported) (Rc, NPT, NPTF, G)</p>

- SV
- SYJ
- SZ
- VF
- VP4
- VQ 1/2
- VQ 4/5
- VQC 1/2
- VQC 4/5
- VQZ
- SQ
- VFS
- VFR
- VQ7

Cylinder Speed Chart

VQC4000

This chart is provided as guidelines only.
For performance under various conditions, use SMC's Model Selection Software before making a judgment.

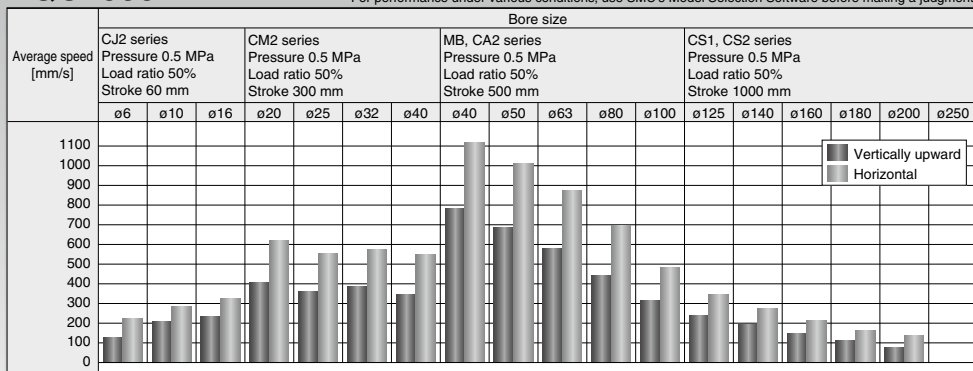

- * Values at extension of a directly coupled cylinder when meter-out speed controllers are used with the needle full open.
- * The average speed of the cylinder is obtained by dividing the stroke by the total stroke time.
- * The load ratio is obtained by the following formula: ((Load mass x 9.8)/Theoretical output) x 100%

Conditions

Base mounted	CJ2 series	CM2 series	MB, CA2 series	CS1, CS2 series
Tube x Length	T0604 x 1 m	T1075 x 1 m	T1209 x 1 m	
Speed controller	AS3002F-06	AS4002F-10	AS4002F-12	
Silencer	AN40-04			AN40-04

Conditions [With SGP (Steel Pipe)]

Body ported	MB, CA2 series	CS1, CS2 series
Tube x Length	SGP10A x 1 m	
Speed controller	AS420-03	
Silencer	AN40-04	

VQC5000

This chart is provided as guidelines only.
For performance under various conditions, use SMC's Model Selection Software before making a judgment.

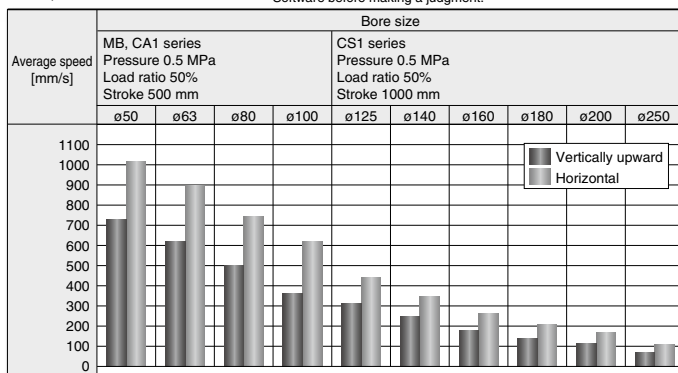

- * Values at extension of a directly coupled cylinder when meter-out speed controllers are used with the needle full open.
- * The average speed of the cylinder is obtained by dividing the stroke by the total stroke time.
- * The load ratio is obtained by the following formula: ((Load mass x 9.8)/Theoretical output) x 100%

Conditions

Speed controller	Silencer	SPG (Steel pipe) dia. x Length
AS420-04	AN40-04	10A x 1 m

INDEX

Sub-plate/Base Mounted: Variations	Page 606
Cylinder Speed Chart	Page 608

VQC4000 Series

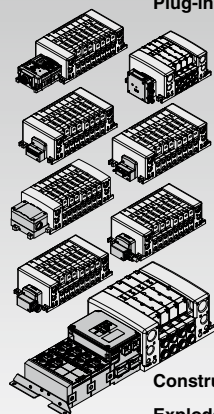

Plug-in: Single Unit	Page 610
Plug-in Unit: Manifold	Page 614
S Kit (Serial transmission kit): EX600 [IP67]/EX500 [IP67]	Page 618
EX260 [IP40/IP67]/EX245 [IP65]/EX250 [IP67]/EX126 [IP67]	
F Kit (D-sub connector kit) [IP40]	Page 626
P Kit (Flat ribbon cable kit) [IP40]	Page 628
T Kit (Terminal block box kit) [IP67]	Page 630
L Kit (Lead wire kit) [IP67]	Page 632
M Kit (Circular connector kit) [IP67]	Page 634
Construction	Page 636
Exploded View of Manifold	Page 637
Specific Product Precautions	Page 642

VQC5000 Series

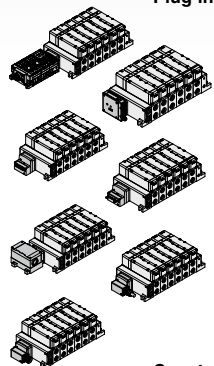

Plug-in: Single Unit	Page 648
Plug-in Unit: Manifold	Page 652
S Kit (Serial transmission kit): EX600 [IP67]/	Page 656
EX500 [IP67]/EX260 [IP40/IP67]/EX250 [IP67]/EX126 [IP67]	
F Kit (D-sub connector kit) [IP40]	Page 664
P Kit (Flat ribbon cable kit) [IP40]	Page 666
T Kit (Terminal block box kit) [IP67]	Page 668
L Kit (Lead wire kit) [IP67]	Page 670
M Kit (Circular connector kit) [IP67]	Page 672
Construction	Page 674
Exploded View of Manifold	Page 675
Specific Product Precautions	Page 680

SV
SYJ
SZ
VF
VP4
VQ 1/2
VQ 4/5
VQC 1/2
VQC 4/5
VQZ
SQ
VFS
VFR
VQ7

Base Mounted

Plug-in: Single Unit

VQC4000 Series

Model

Series	Configuration	Model		Port size	Flow rate characteristics						Response time [ms]		Weight [kg]		
					1 → 4/2 (P → A/B)			4/2 → 5/3 (A/B → EA/EB)			Standard: 0.95 W	Low wattage type: 0.4 W			
					C [dm ³ (s-bar)]	b	Cv	C [dm ³ (s-bar)]	b	Cv					
VQC4000	2-position	Single	Metal seal	VQC4100	3/8	6.2	0.19	1.5	6.9	0.17	1.7	20	22	0.23	
			Rubber seal	VQC4101		7.2	0.43	2.1	7.3	0.38	2.0	25	27		
		Double	Metal seal	VQC4200		6.2	0.19	1.5	6.9	0.17	1.7	12	16		0.26
			Rubber seal	VQC4201		7.2	0.43	2.1	7.3	0.38	2.0	15	17		
	3-position	Closed center	Metal seal	VQC4300		5.9	0.23	1.5	6.3	0.18	1.6	45	47	0.28	
			Rubber seal	VQC4301		7.0	0.34	1.9	6.4	0.42	1.9	50	52		
		Exhaust center	Metal seal	VQC4400		6.2	0.18	1.5	6.9	0.17	1.7	45	47	0.28	
			Rubber seal	VQC4401		7.0	0.38	1.9	7.3	0.38	2.0	50	52		
		Pressure center	Metal seal	VQC4500		6.2	0.18	1.6	6.4	0.18	1.6	45	47	0.28	
			Rubber seal	VQC4501		7.0	0.38	1.9	7.1	0.38	2.0	50	52		
		Double check	Metal seal	VQC4600		2.7	—	—	3.7	—	—	55	57	0.50	
			Rubber seal	VQC4601		2.8	—	—	3.9	—	—	62	64		

Note 1) Cylinder port 3/8: Value for valve on sub-plate

Note 2) Based on JIS B 8419: 2010. (Supply pressure: 0.5 MPa, with indicator light and surge voltage suppressor, clean air. This will change depending on pressure and air quality.) The value when ON for the double type.

Note 3) Table: Without sub-plate, With sub-plate: Add 0.41 kg.



Plug-in unit

Symbol

2-position single

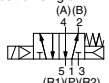

3-position closed center

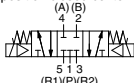

2-position double (Metal)

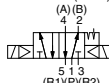

3-position exhaust center

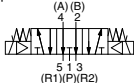

2-position double (Rubber)

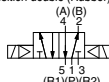

3-position pressure center

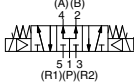

3-position double check

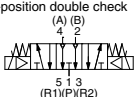

Standard Specifications

Valve specifications	Valve construction	Metal seal	Rubber seal
	Fluid	Air/Inert gas	
Max. operating pressure	1.0 MPa		
Min. operating pressure	Single	0.15 MPa	0.20 MPa
	Double	0.15 MPa	
3-position	0.15 MPa	0.20 MPa	
Ambient and fluid temperature	-10 to 50°C (Note 1)		
Lubrication	Not required		
Manual override	Push type/Locking type (Tool required)/Locking type (Manual)		
Impact/Vibration resistance	150/30 m/s ² (Note 2)		
Enclosure	Dust-tight (IP67 compatible) (Note 3)		
Electrical specifications	Coil rated voltage	12, 24 VDC	
	Allowable voltage fluctuation	±10% of rated voltage	
	Coil insulation type	Class B or equivalent	
	Power consumption [W]	24 VDC	0.95, 0.4
12 VDC		0.95, 0.4	

Note 1) Use dry air to prevent condensation when operating at low temperatures.

Note 2) Impact resistance: No malfunction occurred when it is tested with a drop tester in the axial direction and at the right angles to the main valve and armature in both energized and de-energized states every once for each condition. (Values at the initial period)

Vibration resistance: No malfunction occurred in a one-sweep test between 45 and 2000 Hz. Test was performed at both energized and de-energized states in the axial direction and at the right angles to the main valve and armature. (Values at the initial period)

Note 3) Only applicable to S, T, L and M kits



How to Order Valves

Plug-in **VQC4** **1** **0** **0** - - - **1** - - -

Type of actuation

1	2-position single (A)(B) 4 2 1 3 (R1)(P)(R2)	3-position closed center (A)(B) 4 2 1 3 (R1)(P)(R2)
	2-position double (A)(B) 4 2 1 3 (R1)(P)(R2)	3-position exhaust center (A)(B) 4 2 1 3 (R1)(P)(R2)
2	2-position double (A)(B) 4 2 1 3 (R1)(P)(R2)	3-position pressure center (A)(B) 4 2 1 3 (R1)(P)(R2)
	2-position double (A)(B) 4 2 1 3 (R1)(P)(R2)	3-position double check (A)(B) 4 2 1 3 (R1)(P)(R2)

Note) For double check type, refer to page 478 of the VQ4000/5000 series.

Thread type

Nil	Rc
N	NPT
T	NPTF
F	G

Port size

Nil	Without sub-plate (For manifold)
02	1/4
03	3/8

Porting specifications

Nil	Side ported
B	Bottom ported

Manual override

Nil: Non-locking push type (Tool required)
 B: Locking type (Tool required)
 C: Locking type (Manual)

Light/Surge voltage suppressor

Nil	Yes
E	Without light, with surge voltage suppressor

Coil voltage

5	24 VDC
6	12 VDC

Body

0: Plug-in sub-plate

Seal

0	Metal seal
1	Rubber seal

Function

Nil (Note 1)	Standard (0.95 W)
Y	Low wattage type (0.4 W)
R (Note 2)	External pilot

SV

SYJ

SZ

VF

VP4

VQ 1/2

VQ 4/5

VQC 1/2

VQC 4/5

VQZ

SQ

VFS

VFR

VQ7

How to Order Sub-plates



VQ4000 - PW - - **02** - - -

Porting specifications

Nil	Side ported
B	Bottom ported (Note)

Port size

02	1/4
03	3/8

Note) For bottom ported, port size is 1/4 only.

Thread type

Nil	Rc
N	NPT
T	NPTF
F	G

CE-compliant

Nil	-
Q	CE-compliant

Replacement of pilot valve assembly (Voltage)

- Refer to page 640 for pilot valve assembly part numbers.
- Refer to page 643 for replacement method.



VQC4000 Series

Dimensions: Plug-in Type

Conduit terminal

2-position single: VQC410⁰-□

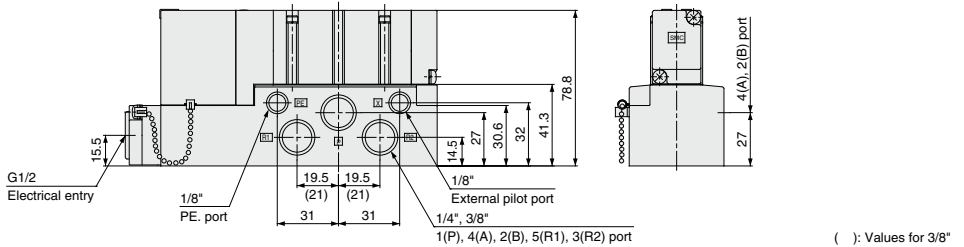
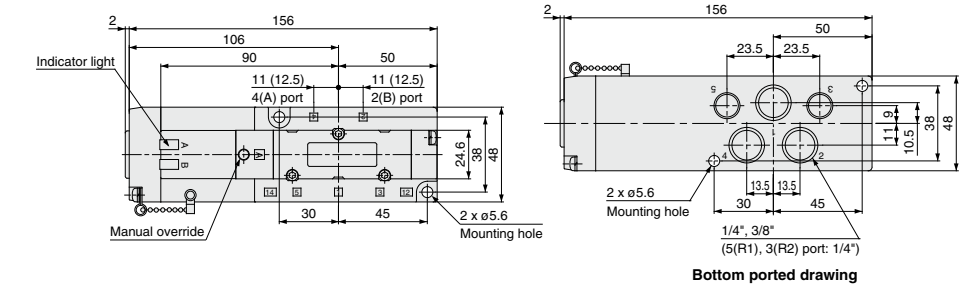

2-position double: VQC420⁰-□

3-position closed center: VQC430⁰-□

3-position exhaust center: VQC440⁰-□

3-position pressure center: VQC450⁰-□

3-position double check: VQC460⁰-□

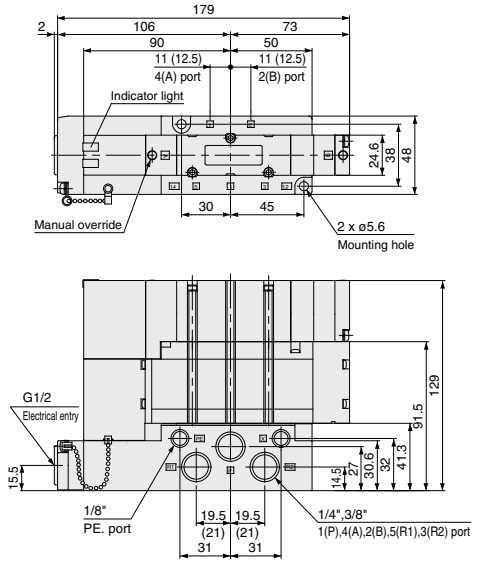
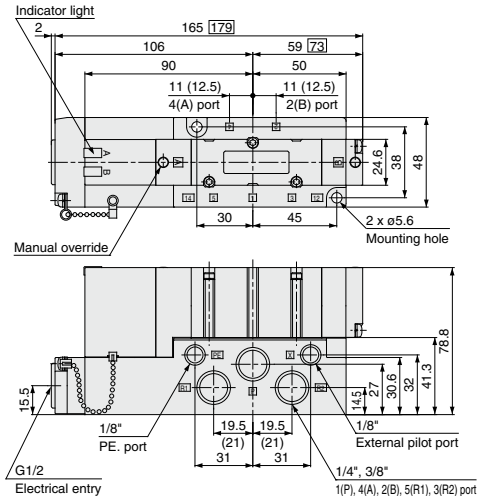

□ : Values for 3-position
() : Values for 3/8"

SV
SYJ
SZ
VF
VP4
VQ 1/2
VQ 4/5
VQC 1/2
VQC 4/5
VQZ
SQ
VFS
VFR
VQ7

Base Mounted

Plug-in Unit

VQC4000 Series

S kit

The selectable items vary for each series. Select from the applicable item numbers in the table below.

Series	Item number (Refer to pages 614, 615 and 615-1)
EX600	1, 2, 3, 5, 8, 9, 10, 11
EX245	1, 2, 3, 5, 6, 7, 11
EX250	1, 2, 3, 5, 9, 11, 12, 13, 14
EX500, 260, 126	1, 2, 3, 5, 9, 11

How to Order Manifold

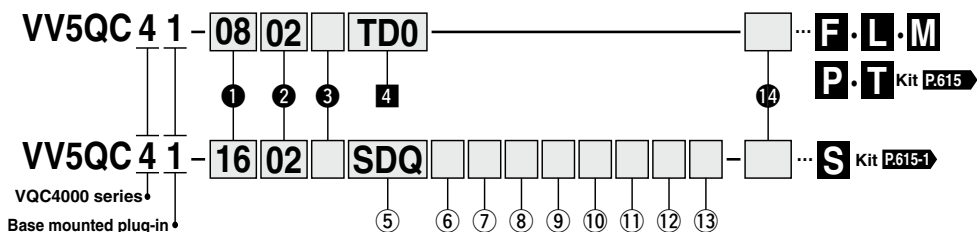

1 Valve stations

01	1 station
...	...

The maximum number of stations differs depending on the electrical entry. (Refer to 11 (5))

Note) In the case of compatibility with the S kit/As-Interface, the maximum number of solenoids is as shown below, so please be careful of the number of stations.

8 in/8 out: Maximum 8 solenoids
4 in/4 out: Maximum 4 solenoids



D side Stations-1-2-3-4-5-6-7-8-R R side

* Stations are counted from station 1 on the D-side.

2 Cylinder port size

C6	With ø6 One-touch fitting	N11	For ø3/8"
C8	With ø8 One-touch fitting	02	1/4
C10	With ø10 One-touch fitting	03	3/8
C12	With ø12 One-touch fitting	B	Bottom ported 1/4
N7	For ø1/4"	CM	Mixed
N9	For ø5/16"		

3 Thread type

Nil	Rc
F	G
N	NPT
T	NPTF

6 With or without I/O modules (Enter EX245-compliant S kit only.)

Nil	Without I/O module
Y	With I/O module

7 Number of I/O modules (Enter EX245-compliant S kit only.)

Nil	Without I/O module (Without SI Unit)
1	1 station
...	...
8	8 stations

8 End plate type (Enter only for EX600-compliant S kit.)

Nil	Without end plate
2	M12 power supply connector, B-coded
3	7/8 inch power supply connector
4	M12 power supply connector IN/OUT, A-coded, Pin arrangement 1
5	M12 power supply connector IN/OUT, A-coded, Pin arrangement 2

Note) Without SI Unit, the symbol is nil.

* The pin layout for "4F" and "5" pin connector is different.

10 I/O Unit stations (Enter only for EX600-compliant S kit.)

Nil	None
1	1 station
...	...
9	9 stations

Note 1) Without SI Unit, the symbol is nil.

Note 2) SI Unit is not included in I/O Unit stations.

Note 3) When I/O Unit is selected, it is shipped separately, and assembled by customer. Refer to the attached operation manual for mounting method.

Note 4) Refer to page 646 for details about the enclosure.

11 Number of input blocks (Enter only for S kit compliant with EX250.)

Nil	Without SI Unit (SDO)
0	Without input block
1	With 1 input block
...	...
4	With 4 input blocks
...	...
8	With 8 input blocks

12 Input block type (Enter only for S kit compliant with EX250.)

Nil	Without input block
1	M12, 2 inputs
2	M12, 4 inputs
3	M8, 4 inputs

13 Input block COM (Enter only for S kit compliant with EX250.)

Nil	PNP sensor input or without input block
N	NPN sensor input

14 Option

Nil	None
K	Special wiring specifications (except for double wiring)
N	With name plate (available for T kit only)
S ^{Note)}	Direct EXH outlet with built-in silencer

Note) The silencer is built into the R port passage of the end plate and the silenced air is exhausted from the R port.

* When two or more symbols are specified, indicate them alphabetically.
Example: -KNS

SV
 SYJ
 SZ
 VF
 VP4
 VQ 1/2
 VQ 4/5
 VQC 1/2
 VQC 4/5
 VQZ
 SQ
 VFS
 VFR
 VQ7

4 Kit type/Electrical entry/Cable length

* Numbers in parentheses represent the maximum number of solenoids in case of mixed single and double wiring. The maximum number of stations is determined by the total number of solenoids. When ordering mixed wiring, please add the option symbol "K".

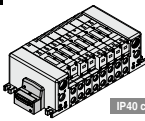
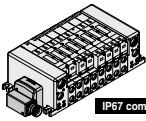
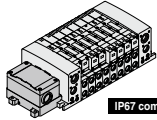
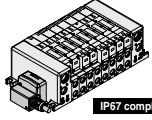
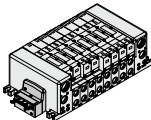
<p>F kit (D-sub connector)  IP40 compliant</p>		<p>M kit (Circular connector)  IP67 compliant</p>		<p>T kit (Terminal block box)  IP67 compliant</p>		<p>L kit (Lead wire)  IP67 compliant</p>	
<p>FD0 D-sub connector (25P) without cable</p>	1 to 12 stations	<p>MD0 Circular connector (26P) without cable</p>	1 to 12 stations	<p>TD0 Terminal block box</p>	<p>LD0 Lead wire 0.6 m lead wire</p>	1 to 12 stations	
<p>FD1 D-sub connector (25P) with 1.5 m cable</p>	(16 stations, 24 points)	<p>MD1 Circular connector (26P) with 1.5 m cable</p>	(16 stations, 24 points)		<p>LD1 Lead wire 1.5 m lead wire</p>	(16 stations, 24 points)	
<p>FD2 D-sub connector (25P) with 3.0 m cable</p>		<p>MD2 Circular connector (26P) with 3.0 m cable</p>			<p>LD2 Lead wire 3.0 m lead wire</p>		
<p>FD3 D-sub connector (25P) with 5.0 m cable</p>		<p>MD3 Circular connector (26P) with 5.0 m cable</p>					
<p>P kit (Flat ribbon cable)  IP40 compliant</p>							
<p>Note) For a 20P flat ribbon cable, the cable assembly must be ordered separately.</p>							
<p>PD0 Flat ribbon cable (26P) without cable</p>							
<p>PD1 Flat ribbon cable (26P) with 1.5 m cable</p>	1 to 12 stations						
<p>PD2 Flat ribbon cable (26P) with 3.0 m cable</p>	(16 stations, 24 points)						
<p>PD3 Flat ribbon cable (26P) with 5.0 m cable</p>							
<p>PDC Flat ribbon cable (20P) without cable</p>	1 to 9 stations (16 stations, 18 points)						

VQC4000 Series

5 Kit type/Electrical entry/Cable length

* Numbers in parentheses represent the maximum number of solenoids in case of mixed single and double wiring. The maximum number of stations is determined by the total number of solenoids. When ordering mixed wiring, please add the option symbol "K".

S kit
(Serial transmission kit (Fieldbus system) :
EX600 integrated-type (for I/O))

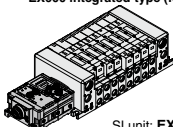

SI unit: **EX600** IP67 compliant

SD60	Without SI unit	1 to 12 stations (16 stations, 24 points)
SD6Q	DeviceNet™	
SD6N	PROFIBUS DP	
SD6V	CC-Link	
SD6F	PROFINET	
SD6ZE	EtherNet/IP™ (1 port)	
SD6EA	EtherNet/IP™ (2 port)	
SD6D	EtherCAT	
SD6WE	EtherNet/IP™ compatible wireless base	
SD6WF	PROFINET compatible wireless base	
SD6WS	Wireless remote	

S kit
(Serial transmission kit: EX500 gateway-type)

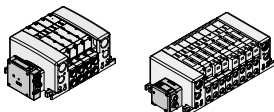

SI unit: **EX500** IP67 compliant

Note) A separate gateway unit and communication cable are required.

SD0A	Without SI unit	—	—
SDA3	EX500 Gateway Decentralized System 2 (128 points)	32 outputs (16 stations, 24 points)	1 to 12 stations (16 stations, 24 points)
SDA2	EX500 Gateway Decentralized System (64 points)	16 outputs (16 stations, 16 points)	1 to 8 stations (16 stations, 16 points)

S kit
(Serial transmission kit: EX260 integrated-type (for output))

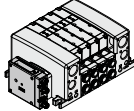

SI unit: **EX260** IP40 compliant IP67 compliant

Symbol	Protocol	Number of outputs	Communication connector	Stations
Without SI unit				
SD0A				1 to 12 stations
SQA	DeviceNet™	32	M12	(16 stations, 24 points)
SQB		16		1 to 8 stations (16 stations, 16 points)
SNA		32	M12	1 to 12 stations (16 stations, 24 points)
SNB	PROFIBUS DP	16		1 to 8 stations (16 stations, 16 points)
SNC		32		1 to 12 stations (16 stations, 24 points)
SND		16	D-sub	1 to 8 stations (16 stations, 16 points)
SVA	CC-Link	32	M12	1 to 12 stations (16 stations, 24 points)
SVB		16		1 to 8 stations (16 stations, 16 points)
SDA	EtherCAT	32	M12	1 to 12 stations (16 stations, 24 points)
SDB		16		1 to 8 stations (16 stations, 16 points)
SFA	PROFINET	32	M12	1 to 12 stations (16 stations, 24 points)
SFB		16		1 to 8 stations (16 stations, 16 points)
SEA	EtherNet/IP™	32	M12	1 to 12 stations (16 stations, 24 points)
SEB		16		1 to 8 stations (16 stations, 16 points)
SGA	Ethernet POWERLINK	32	M12	1 to 12 stations (16 stations, 24 points)
SGB		16		1 to 8 stations (16 stations, 16 points)
SKA	IO-Link	32	M12	1 to 12 stations (16 stations, 24 points)

S kit
(Serial transmission: EX245 integrated-type (for I/O))

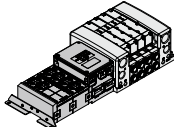

SI unit: **EX245** IP65 compliant

Symbol	Protocol	Communication connector	Communication connector specifications	Stations
Without SI unit				
SD0B				1 to 12 stations (16 stations, 24 points)
SDAAN		Push/Pull (SCRJ); 2 pcs.	Push/Pull (24 V); 2 pcs.	1 to 12 stations (16 stations, 24 points)
SDABN	PROFINET	Push/Pull (RJ45); 2 pcs.	Push/Pull (24 V); 2 pcs.	1 to 8 stations (16 stations, 16 points)
SDACN		M12: 2 pcs.	7/8 inch: 2 pcs.	1 to 12 stations (16 stations, 24 points)

S kit
(Serial transmission kit: EX126 integrated-type (for output))

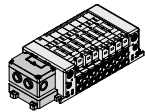

SI unit: **EX126** IP67 compliant

SDVB	CC-Link	1 to 8 stations (16 stations, 16 points)
-------------	---------	------------------------------------------

S kit
(Serial transmission kit: EX250 integrated-type (for I/O))

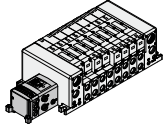

SI unit: **EX250** IP67 compliant

SD0	Without SI unit	1 to 12 stations (16 stations, 24 points)
SDQ	DeviceNet™	
SDN	PROFIBUS DP	
SDTA	AS-Interface, 8 in/8 out, 31 slave modes, 2 power supply systems	1 to 4 stations (8 stations, 8 points)
SDTB	AS-Interface, 4 in/4 out, 31 slave modes, 2 power supply systems	1 to 2 stations (4 stations, 4 points)
SDTC	AS-Interface, 8 in/8 out, 31 slave modes, 1 power supply systems	1 to 4 stations (8 stations, 8 points)
SDTD	AS-Interface, 4 in/4 out, 31 slave modes, 1 power supply systems	1 to 2 stations (4 stations, 4 points)
SDY	CANopen	1 to 12 stations (16 stations, 24 points)
SDZEN	EtherNet/IP™	

9 SI unit output polarity

SI unit output polarity		EX250 integrated-type (I/O) serial transmission system				
		DeviceNet™	PROFIBUS DP	AS-Interface	CANopen	EtherNet/IP™
NH	Positive common	—	—	—	—	—
N	Negative common	○	○	○	○	○

SI unit output polarity		EX245 integrated-type (I/O) serial transmission system	EX260 integrated-type (for output) serial transmission system							
		PROFINET	DeviceNet™	PROFIBUS DP	CC-Link	EtherCAT	PROFINET	EtherNet/IP™	Ethernet POWERLINK	IO-Link
NH	Positive common	—	—	○	○	○	○	○	○	—
N	Negative common	○	○	○	○	○	○	○	○	○

SI unit output polarity		EX500 Gateway Decentralized System 2 (128 points)			EX500 Gateway Decentralized System (64 points)			
		EtherNet/IP™	PROFINET	DeviceNet™	PROFIBUS DP	EtherNet/IP™	PROFINET	EtherNet/IP™
NH	Positive common	—	—	○	○	○	○	○
N	Negative common	○	○	○	○	○	○	○

SI unit output polarity		EX600 integrated-type (I/O) serial transmission system								
		DeviceNet™	PROFIBUS DP	CC-Link	EtherNet/IP™	EtherCAT	PROFINET	EtherNet/IP™ compatible wireless base	PROFINET compatible wireless base	Wireless remote
NH	Positive common	○	○	○	○	○	○	○	○	○
N	Negative common	○	○	○	○	○	○	○	○	○

* Leave the box blank for without SI Unit (SD0□, SD6□).



How to Order Valves

VQC4000 series • **VQC 4** 1 0 0 - 5 **1**

A B C D E F

(A) Type of actuation

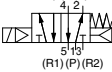
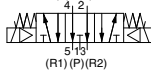
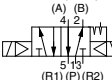
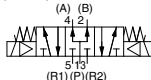
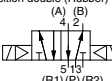
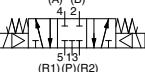
1	2-position single (A) (B)  (R1) (P) (R2)	4	3-position exhaust center (A) (B)  (R1) (P) (R2)
2	2-position double (Metal) (A) (B)  (R1) (P) (R2)	5	3-position pressure center (A) (B)  (R1) (P) (R2)
	2-position double (Rubber) (A) (B)  (R1) (P) (R2)		6
3	3-position closed center (A) (B)  (R1) (P) (R2)		

(B) Seal type

0	Metal seal
1	Rubber seal

(C) Function

Nil ^{Note 1)}	Standard (0.95 W)
Y	Low wattage type (0.4 W)
R ^{Note 2)}	External pilot

Note 1) When the power is energized continuously, refer to "Specific Product Precautions 1" on page 642.

Note 2) For details about external pilot type, refer to page 481 of the VQ4000/5000 series.

+ When multiple symbols are specified, indicate them alphabetically.

(D) Coil voltage

5	24 VDC ^{Note)}
6	12 VDC

Note) S kit is only available for 24 VDC.

(E) Light/Surge voltage suppressor

Nil	Yes
E	Without light, with surge voltage suppressor

(F) Manual override

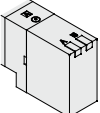
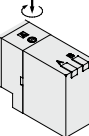
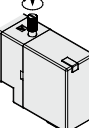
Nil	Non-locking push type (Tool required) 
B	Push-turn locking type (Tool required) 
C	Turn locking type (Manual) 

VQC4000 Series

How to Order Manifold Assembly: EX600*1

Example (VV5QC41-□SD6□)

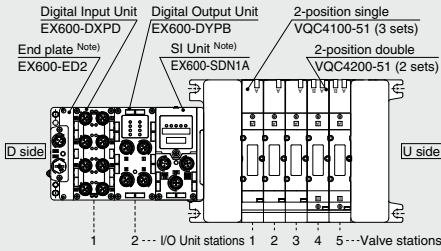

VV5QC41-0502SD6Q2N2---1 set (\$ kit 5-station manifold base part number)
 *VQC4100-51.....3 sets (2-position single part number)
 *VQC4200-51.....2 sets (2-position double part number)
 *EX600-DXPD.....1 set I/O Unit part number (Station 1)
 *EX600-DYPB.....1 set I/O Unit part number (Station 2)
 *The asterisk denotes the symbol for assembly.
 Prefix it to the part numbers of the valve etc.

- The valve arrangement is numbered as the 1st station from the D side.
- Under the manifold part number, state the valves to be mounted, then the I/O Units in order from the 1st station as shown in the figure above. If the arrangement becomes complicated, specify on a manifold specification sheet.

Note) Do not enter the SI Unit part number and the end plate part number together.

How to Order Manifold Assembly: EX245*

Example (VV5QC41-□SDAAN□)

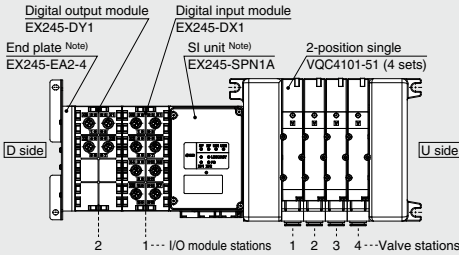

VV5QC41-04C8SDAANY2---1 set (\$ kit 4-station manifold base part no.)
 *VQC4101-51.....4 sets (2-position single part no.)
 *EX245-DX1.....1 set I/O unit part number (Station 1)
 *EX245-DY1.....1 set I/O unit part number (Station 2)
 *The asterisk denotes the symbol for assembly.
 Prefix it to the part numbers of the valve etc.

- The valve arrangement is numbered as the 1st station from the D side.
- Under the manifold part number, state the valves to be mounted, then the I/O module in order from the 1st station as shown in the figure above. If the arrangement becomes complicated, specify on a manifold specification sheet.

Note) Do not enter the SI Unit part number and the end plate part number together.

* The EX245/250 I/O module (block) station arrangement is numbered starting from the SI unit side.

Manifold Specifications

Series	Base model	Connection type	Piping specifications			Note 2) Applicable stations	Applicable solenoid valve	5-station weight [g]
			Port direction	Port size Note 1)				
				1, 3 (P, R)	2, 4 (A, B)			
VQC4000	VV5QC41-□□□	<ul style="list-style-type: none"> ■ F kit: D-sub connector ■ P kit: Flat ribbon cable ■ T kit: Terminal block box ■ S kit: Serial transmission ■ L kit: Lead wire ■ M kit: Circular connector 	Side	P: 1/2 (Rc, G, NPT/NPTF) R: 3/4 (Rc, G, NPT/NPTF)	C6 (for ø6) C8 (for ø8) C10 (for ø10) C12 (for ø12) 1/4 (Rc, G, NPT/NPTF) 3/8 (Rc, G, NPT/NPTF)	(F, L, M, P kit 1 to 12 stations) (T kit 1 to 10 stations) (S kit Note 3) 1 to 12 stations: D153, D1215 1 to 8 stations: D1530, D1600	VQC4□00-51 VQC4□01-51	2282 S kit (Without Unit) Not including valve weight.
			Bottom	1/4 (Rc, G, NPT/NPTF)				

Note 1) One-touch fittings in inch sizes are also available.

Note 2) An optional specification for special wiring is available to increase the maximum number of stations.

Note 3) Depending on the protocol, there is a limit to the number of stations an S kit can be applied to. Refer to page 615-1 for details.

SI Unit Part Number Table

EX600 Integrated type (For Input/Output)				
Symbol	Applicable protocol	SI Unit part no.		Page
		Negative common (PNP)	Positive common (NPN)	
SD6Q	DeviceNet™	EX600-SDN1A	EX600-SDN2A	638
SD6N	PROFIBUS DP	EX600-SPR1A	EX600-SPR2A	
SD6V	CC-Link	EX600-SMJ1	EX600-SMJ2	
SD6F	PROFINET	EX600-SPN1	EX600-SPN2	
SD6ZE	EtherNet/IP™ (1 port)	EX600-SEN1	EX600-SEN2	
SD6EA	EtherNet/IP™ (2 port)	EX600-SEN3	EX600-SEN4	
SD6D	EtherCAT	EX600-SEC1	EX600-SEC2	
SD6WE	EtherNet/IP™ compatible wireless base ^{Note)}	EX600-WEN1	EX600-WEN2	
SD6WF	PROFINET compatible wireless base ^{Note)}	EX600-WPN1	EX600-WPN2	
SD6WS	Wireless remote ^{Note)}	EX600-WSV1	EX600-WSV2	

Note) The wireless system is suitable for use only in a country where it is in accordance with the Radio Act and regulations of that country.

EX245 Integrated type (For Input/Output)			
Symbol	Compatible protocol	SI unit part no.	Page
SDAAN	PROFINET	EX245-SPN1A	639
SDABN		EX245-SPN2A	
SDACN		EX245-SPN3A	

EX260 Integrated type (For Output)					
Symbol	Applicable protocol	Number of outputs	SI Unit part no.		Page
			Negative common (PNP)	Positive common (NPN)	
SQA	DeviceNet™	32	EX260-SDN1	EX260-SDN2	639
SQB		16	EX260-SDN3	EX260-SDN4	
SNA		32	EX260-SPR1	EX260-SPR2	
SNB	PROFIBUS DP	16	EX260-SPR3	EX260-SPR4	
SNC		32	EX260-SPR5	EX260-SPR6	
SND		16	EX260-SPR7	EX260-SPR8	
SVA	CC-Link	32	EX260-SMJ1	EX260-SMJ2	M12
SVB		16	EX260-SMJ3	EX260-SMJ4	
SDA	EtherCAT	32	EX260-SEC1	EX260-SEC2	M12
SDB		16	EX260-SEC3	EX260-SEC4	
SFA	PROFINET	32	EX260-SPN1	EX260-SPN2	M12
SFB		16	EX260-SPN3	EX260-SPN4	
SEA	EtherNet/IP™	32	EX260-SEN1	EX260-SEN2	M12
SEB		16	EX260-SEN3	EX260-SEN4	
SGA	Ethernet POWERLINK	32	EX260-SPL1	—	M12
SGB		16	EX260-SPL3	—	
SKA	IO-Link	32	EX260-SIL1	—	M12

EX126 Integrated type (For Output)			
Symbol	Applicable protocol	SI unit part no.	Page
SDVB	CC-Link, Positive common (NPN)	EX126D-SMJ1	639

EX500 Gateway Decentralized System 2 (128 points)				
Symbol	Applicable protocol	SI Unit part no.		Page
		Negative common (PNP)		
SDA3	EtherNet/IP™ PROFINET	EX500-S103		638

EX500 Gateway Decentralized System (64 points)				
Symbol	Applicable protocol	SI Unit part no.		Page
		Positive common (NPN)	Negative common (PNP)	
SDA2	DeviceNet™ PROFIBUS DP EtherNet/IP™	EX500-Q001	EX500-Q101	638

EX250 Integrated type (For Input/Output)			
Symbol	Applicable protocol	SI Unit part no.	Page
SDQ	DeviceNet™, Negative common (PNP)	EX250-SDN1	639
SDN	PROFIBUS DP, Negative common (PNP)	EX250-SPR1	
SDTA	AS-Interface, Negative common (PNP), (8 in/8 out, 31 slave modes, 2 power supply systems)	EX250-SAS3	
SDTB	AS-Interface, Negative common (PNP), (4 in/4 out, 31 slave modes, 2 power supply systems)	EX250-SAS5	
SDTC	AS-Interface, Negative common (PNP), (8 in/8 out, 31 slave modes, 1 power supply system)	EX250-SAS7	
SDTD	AS-Interface, Negative common (PNP), (4 in/4 out, 31 slave modes, 1 power supply system)	EX250-SAS9	
SDY	CANopen, Negative common (PNP)	EX250-SCA1A	
SDZEN	EtherNet/IP™, Negative common (PNP)	EX250-SEN1	

For details about the EX series (Serial Transmission System), refer to Best Pneumatics No. 1-1 and the Operation Manual. Please download the Operation Manual via SMC website, <http://www.smworld.com>

Manifold Options

For details about options, refer to page 476 or later of the VQ4000 series.

Blanking plate assembly
VVQ4000-10A-1

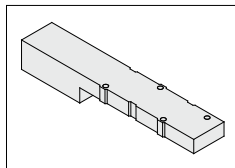

Individual SUP spacer
VVQ4000-P-1-02_03

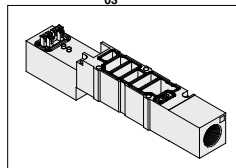

Individual EXH spacer
VVQ4000-R-1-02_03

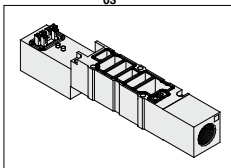

SUP/EXH block plate
VVQ4000-16A (1 pc./set)

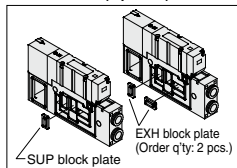

Restrictor spacer
VVQ4000-20A-1

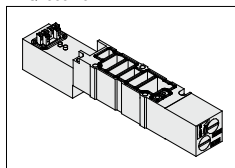

Double check spacer with residual pressure exhaust
VVQ4000-25A-1 ^{Note)}

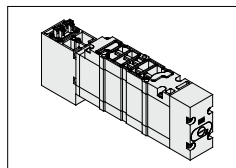

SUP stop valve spacer
VVQ4000-37A-1

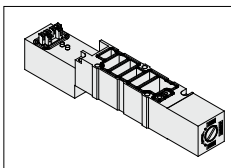

Interface regulator (P, A, B port regulation)
ARBQ4000-00-β-1

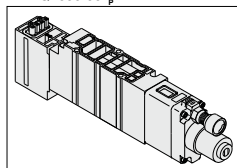

Note) The double check spacer with residual pressure release valve cannot be combined with external pilot type.

For replacement parts, refer to page 640.

VQC4000 Series

S VQC4000

Kit (Serial transmission kit): For EX600 Integrated-type (I/O) Serial Transmission System IP67 compliant

VV5QC41

S kit (Serial transmission kit: EX600)

Power supply with M12 connector

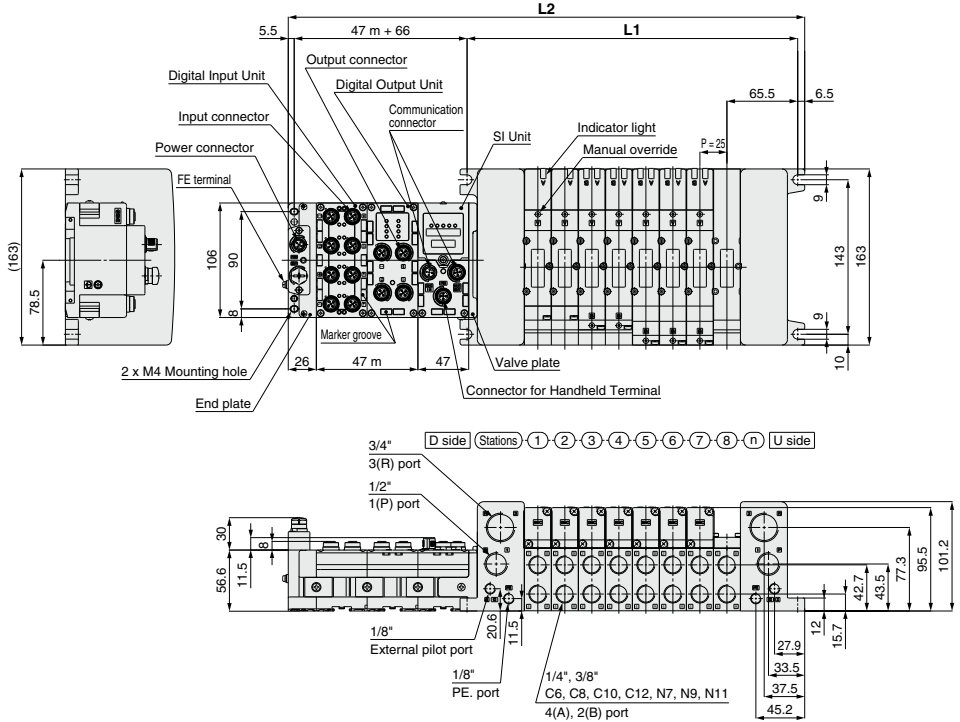

Bottom ported

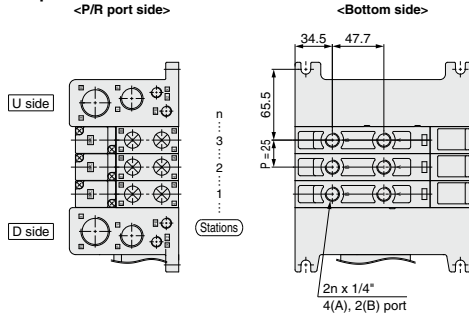

* Other dimensions are the same as the side ported type.

Dimensions

Formula: L1 = 25n + 106, L2 = 25n + 184 + L2 is the dimension without I/O Unit. Add 47 mm for each additional I/O Units. * "m" is number of I/O Units. n: Stations (Maximum 16 stations)

L	n	1	2	3	4	5	6	7	8	9	10	11	12	13	14	15	16
L1		131	156	181	206	231	256	281	306	331	356	381	406	431	456	481	506
L2		209	234	259	284	309	334	359	384	409	434	459	484	509	534	559	584



VQC4000

Kit (Serial transmission kit): For EX600 Integrated-type (I/O) Serial Transmission System IP67 compliant

VV5QC41

S kit (Serial transmission kit: EX600)

Power supply with 7/8 inch connector

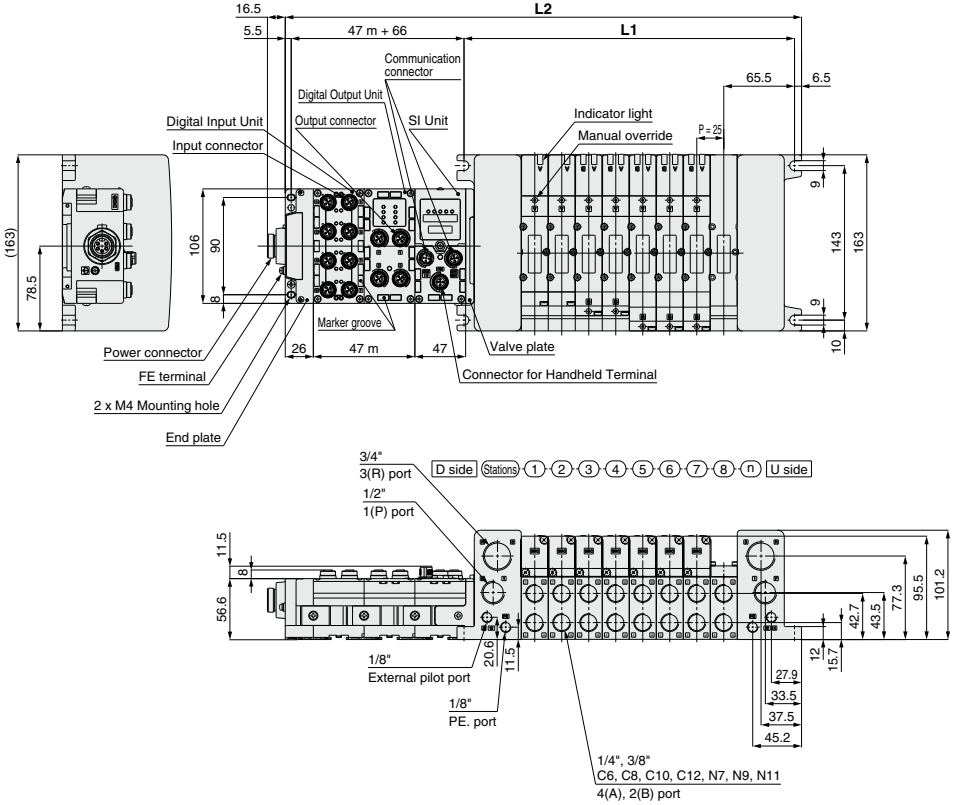

- SV
- SYJ
- SZ
- VF
- VP4
- VQ 1/2
- VQ 4/5
- VQC 1/2
- VQC 4/5
- VQZ
- SQ
- VFS
- VFR
- VQ7

Note) The dimensions of the bottom ported type are common to all S kits.

Dimensions

Formula: L1 = 25n + 106, L2 = 25n + 184 * L2 is the dimension without I/O Unit. Add 47 mm for each additional I/O Units. * "n" is number of I/O Units. n: Stations (Maximum 16 stations)

L	n	1	2	3	4	5	6	7	8	9	10	11	12	13	14	15	16
L1		131	156	181	206	231	256	281	306	331	356	381	406	431	456	481	506
L2		209	234	259	284	309	334	359	384	409	434	459	484	509	534	559	584

VQC4000 Series

S VQC4000

Kit (Serial transmission kit): For EX500 Gateway Decentralized System 2 (128 points) IP67 compliant

VV5QC41

S kit (Serial transmission kit: EX500)

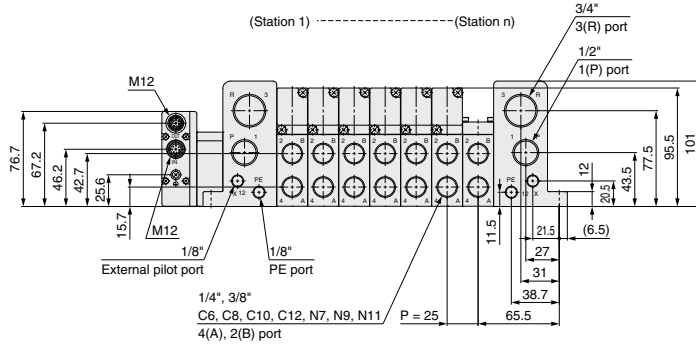
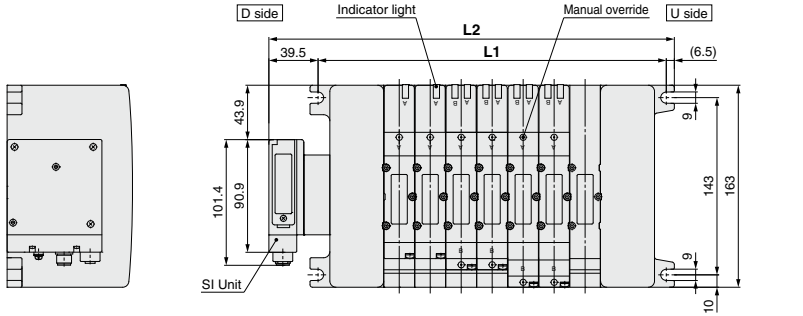

Note) The dimensions of the bottom ported type are common to all S kits.

Formula: $L1 = 25n + 106$, $L2 = 25n + 152$ n: Stations (Maximum 16 stations)

n	1	2	3	4	5	6	7	8	9	10	11	12	13	14	15	16
L1	131	156	181	206	231	256	281	306	331	356	381	406	431	456	481	506
L2	177	202	227	252	277	302	327	352	377	402	427	452	477	502	527	552



VQC4000

Kit (Serial transmission kit): For EX500 Gateway Decentralized System (64 points) IP67 compliant

VV5QC41

S kit (Serial transmission kit: EX500)

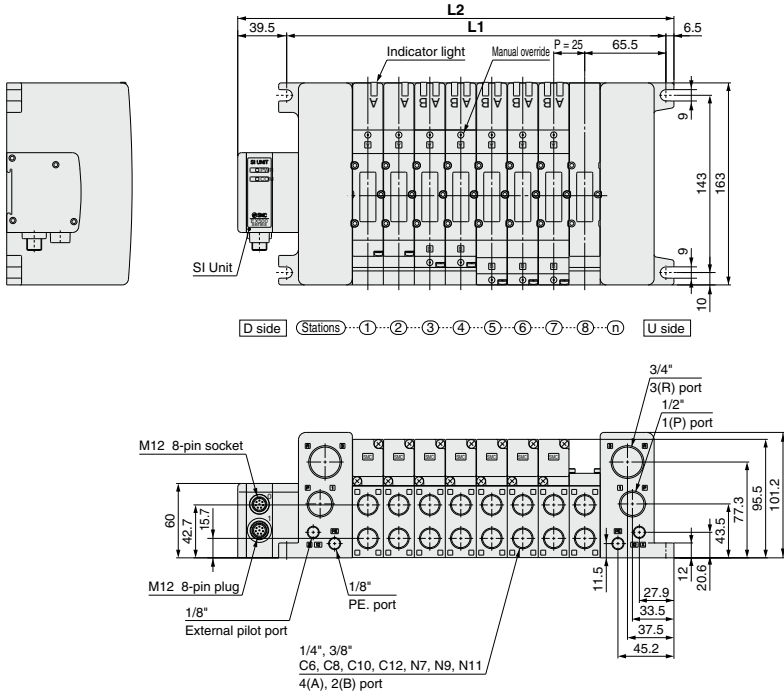

- SV
- SYJ
- SZ
- VF
- VP4
- VQ 1/2
- VQ 4/5
- VQC 1/2
- VQC 4/5
- VQZ
- SQ
- VFS
- VFR
- VQ7

Note) The dimensions of the bottom ported type are common to all S kits.

Dimensions

Formula: L1 = 25n + 106, L2 = 25n + 152 n: Stations (Maximum 16 stations)

L \ n	1	2	3	4	5	6	7	8	9	10	11	12	13	14	15	16
L1	131	156	181	206	231	256	281	306	331	356	381	406	431	456	481	506
L2	177	202	227	252	277	302	327	352	377	402	427	452	477	502	527	552

VQC4000 Series

S VQC4000

Kit (Serial transmission kit): For EX260 Integrated-type (Output) Serial Transmission System

IP40 compliant

IP67 compliant

VV5QC41

S kit (Serial transmission kit: EX260)

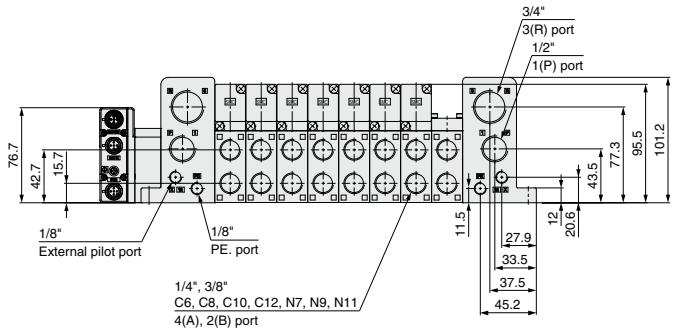
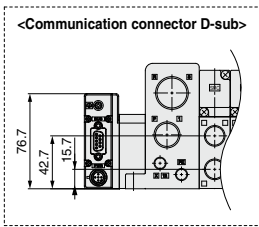
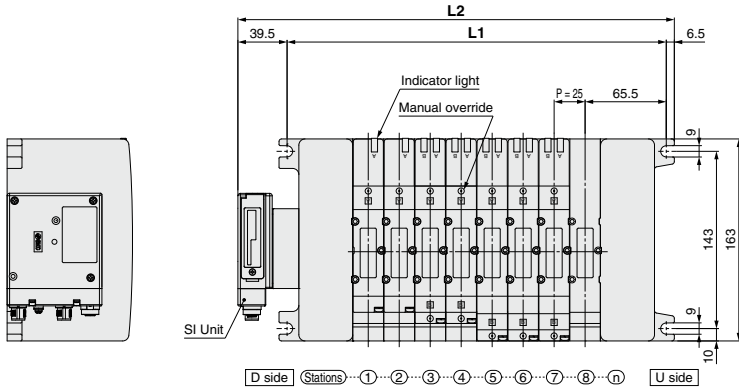

Note) The dimensions of the bottom ported type are common to all S kits.

Dimensions

n: Stations (Maximum 16 stations)

L \ n	1	2	3	4	5	6	7	8	9	10	11	12	13	14	15	16
L1	131	156	181	206	231	256	281	306	331	356	381	406	431	456	481	506
L2	177	202	227	252	277	302	327	352	377	402	427	452	477	502	527	552



VQC4000

Kit (Serial transmission kit): For EX245 Integrated-type (I/O) Serial Transmission System IP65 compliant

VV5QC41

S kit

(Serial transmission: EX245)

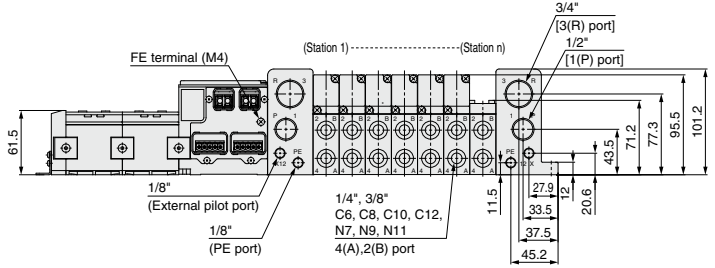
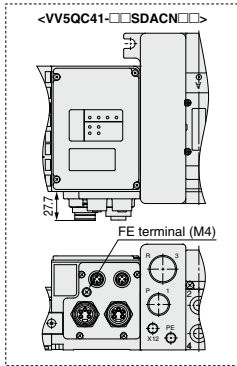
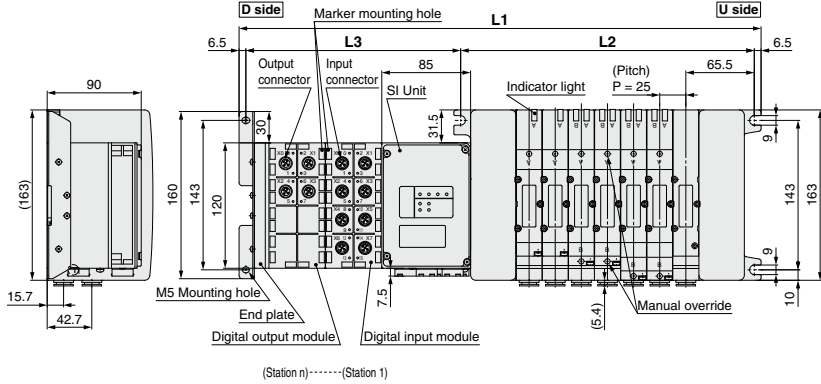

SV
SYJ
SZ
VF
VP4
VQ 1/2
VQ 4/5
VQC 1/2
VQC 4/5
VQZ
SQ
VFS
VFR
VQ7

$L3 = 54n2 + 97.6$

Dimensions Formula/L1 = 25n + 216.6 L2 = 25n + 106 * The L1 dimension is the dimension without an I/O module. Add 54 mm to this dimension for each I/O module. * n2 is the number of I/O module stations.

L	n	1	2	3	4	5	6	7	8	9	10	11	12	13	14	15	16
L1		241.6	266.6	291.6	316.6	341.6	366.6	391.6	416.6	441.6	466.6	491.6	516.6	541.6	566.6	591.6	616.6
L2		131	156	181	206	231	256	281	306	331	356	381	406	431	456	481	506

S VQC4000

Kit (Serial transmission kit): For EX250 Integrated-type (I/O) Serial Transmission System **IP67 compliant**

VV5QC41
S kit
(Serial transmission kit: EX250)

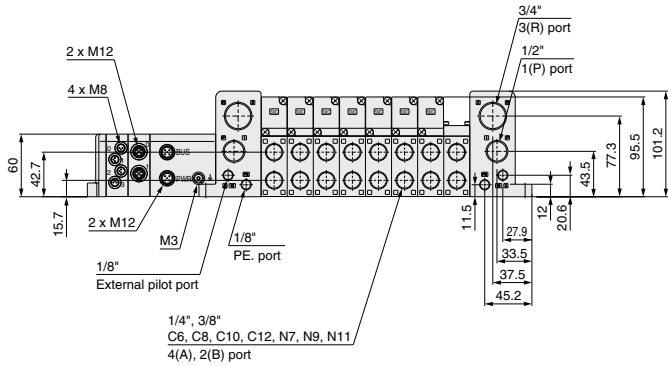
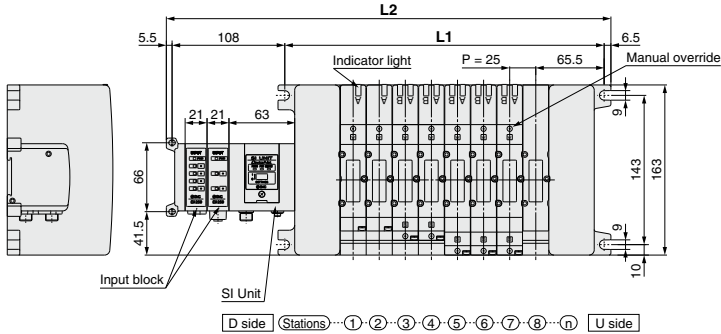

Note) The dimensions of the bottom ported type are common to all S kits.

Dimensions

Formula: $L1 = 25n + 106$, $L2 = 25n + 205$ (For one input block. Add 21 mm for each additional input block.) n: Stations (Maximum 16 stations)

$L \setminus n$	1	2	3	4	5	6	7	8	9	10	11	12	13	14	15	16
L1	131	156	181	206	231	256	281	306	331	356	381	406	431	456	481	506
L2	230	255	280	305	330	355	380	405	430	455	480	505	530	555	580	605

- SV
- SYJ
- SZ
- VF
- VP4
- VQ 1/2
- VQ 4/5
- VQC 1/2
- VQC 4/5
- VQZ
- SQ
- VFS
- VFR
- VQ7

VQC4000 Series

S VQC4000

Kit (Serial transmission kit): For EX126 Integrated-type (Output) Serial Transmission System **IP67 compliant**

VV5QC41

S kit (Serial transmission kit: EX126)

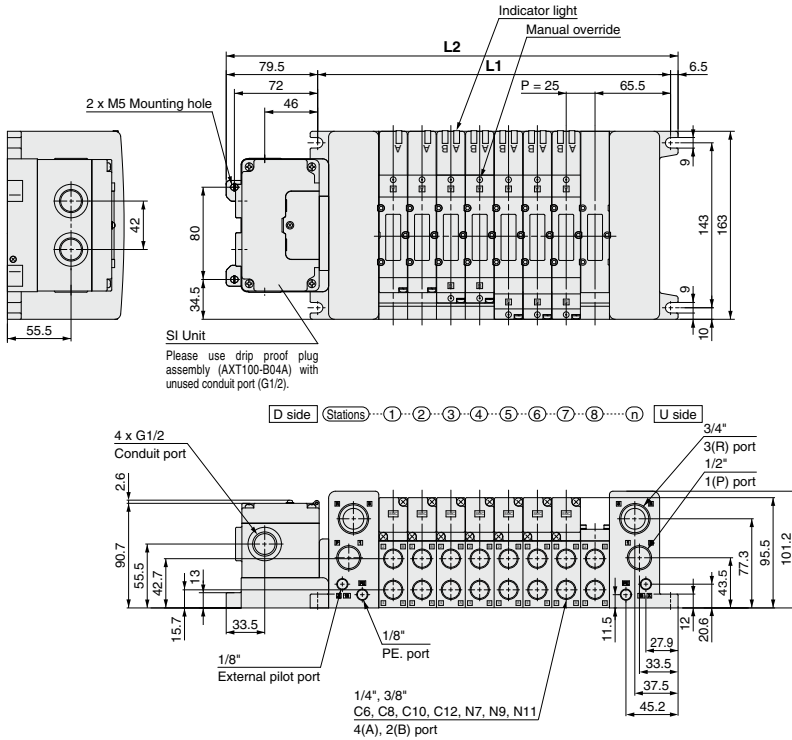

Note) The dimensions of the bottom ported type are common to all S kits.

Dimensions

Formula: L1 = 25n + 106, L2 = 25n + 192 n: Stations (Maximum 16 stations)

L \ n	1	2	3	4	5	6	7	8	9	10	11	12	13	14	15	16
L1	131	156	181	206	231	256	281	306	331	356	381	406	431	456	481	506
L2	217	242	267	292	317	342	367	392	417	442	467	492	517	542	567	592

SV
SYJ
SZ
VF
VP4
VQ 1/2
VQ 4/5
VQC 1/2
VQC 4/5
VQZ
SQ
VFS
VFR
VQ7

VQC4000 Series

F VQC4000 Kit (D-sub connector kit) IP40 compliant

- Using our D-sub connector for electrical connections greatly reduces labor, while it also minimizes wiring and saves space.
- We use a D-sub connector (25P) that conforms to MIL standards and is therefore widely compatible with many standard commercial models.
- Top or side entry for the connector can be changed freely, allowing for changes even after mounting, to meet any changing needs for space.

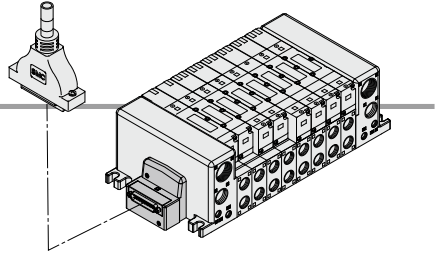

Electrical Wiring Specifications

D-sub connector

As the standard electrical wiring specification used is for 12 stations or less, double wiring (connected to SOL. A and SOL. B) is used for the internal wiring of each station regardless of valve and option types. Mixed single and double wiring are available as options. Refer to special wiring specifications (options) below.

Lead wire colors for D-sub connector assemblies (AXT100-DS25-015, 030, 050)

Standard wiring	Terminal no.	Lead wire color	Dot marking	
Station 1	SOL.A	1	Black	None
	SOL.B	14	Yellow	Black
Station 2	SOL.A	2	Brown	None
	SOL.B	15	Pink	Black
Station 3	SOL.A	3	Red	None
	SOL.B	16	Blue	White
Station 4	SOL.A	4	Orange	None
	SOL.B	17	Purple	None
Station 5	SOL.A	5	Yellow	None
	SOL.B	18	Gray	None
Station 6	SOL.A	6	Pink	None
	SOL.B	19	Orange	Black
Station 7	SOL.A	7	Blue	None
	SOL.B	20	Red	White
Station 8	SOL.A	8	Purple	White
	SOL.B	21	Brown	White
Station 9	SOL.A	9	Gray	Black
	SOL.B	22	Pink	Red
Station 10	SOL.A	10	White	Black
	SOL.B	23	Gray	Red
Station 11	SOL.A	11	White	Red
	SOL.B	24	Black	White
Station 12	SOL.A	12	Yellow	Red
	SOL.B	25	White	None
COM.	13	Orange	Red	

Special Wiring Specifications (Options)

(For 25P)

Mixed single and double wiring are available as options. The maximum number of manifold stations is determined by the number of solenoids. Count one point for a single solenoid type and two points for a double solenoid type. The total number of solenoids (points) must not exceed 24.

Cable Assembly

AXT100-DS25-030
015
050

(D-sub connector cable assemblies can be ordered with manifolds.)
(Refer to manifold ordering.)

Lead wire colors for D-sub connector cable assembly terminal numbers

Terminal no.	Lead wire color	Dot marking
1	Black	None
2	Brown	None
3	Red	None
4	Orange	None
5	Yellow	None
6	Pink	None
7	Blue	None
8	Purple	White
9	Gray	Black
10	White	Black
11	White	Red
12	Yellow	Red
13	Orange	Red
14	Yellow	Black
15	Pink	Black
16	Blue	White
17	Purple	None
18	Gray	None
19	Orange	Black
20	Red	White
21	Brown	White
22	Pink	Red
23	Gray	Red
24	Black	White
25	White	None

D-sub connector cable assemblies

Cable length [L]	Part no.	Note
1.5 m	AXT100-DS25-015	Cable 0.3 mm² x 25 cores
3 m	AXT100-DS25-030	
5 m	AXT100-DS25-050	

- * When using a standard commercial connector, use a type 25P female connector conforming to MIL-C-24308.
- * Cannot be used for transfer wiring.
- * Lengths other than the above is also available. Please contact SMC for details.

Electrical characteristics

Item	Characteristic
Conductor resistance Ω/km, 20°C	65 or less
Voltage limit V, 1 minute, AC	1000
Insulation resistance MΩ/km, 20°C	5 or more

(Note) The minimum bending radius for D-sub connector cables is 20 mm.

Connector Manufacturers Example

- Fujitsu, Limited
- Japan Aviation Electronics Industry, Limited
- J.S.T. Mfg. Co., Ltd.
- HIROSE ELECTRIC CO., LTD.

F VQC4000

Kit (D-sub connector kit) IP40 compliant

VV5QC41

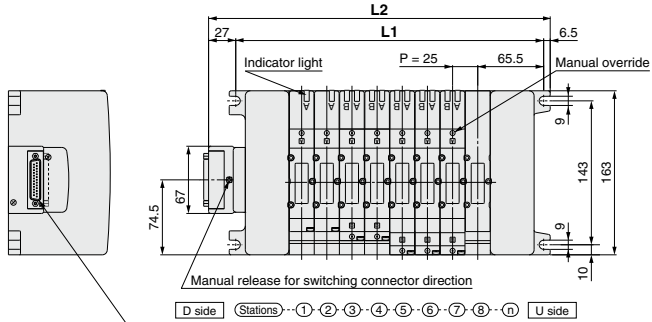

Applicable connector: D-sub connector (25P)
(Conforms to MIL-C-24308)

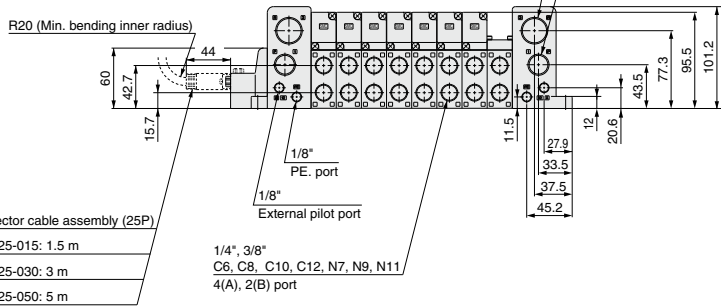

D-sub connector cable assembly (25P)
AXT100-DS25-015: 1.5 m
AXT100-DS25-030: 3 m
AXT100-DS25-050: 5 m

Bottom ported

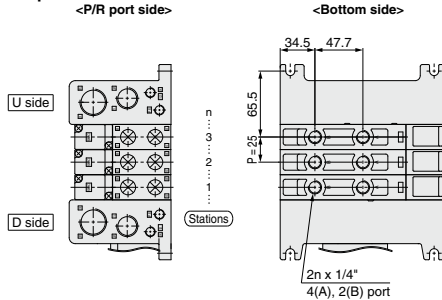

* Other dimensions are the same as the side ported type.

Dimensions

Formula: L1= 25n + 106, L2 = 25n + 139.5 n: Stations (Maximum 16 stations)

L	n	1	2	3	4	5	6	7	8	9	10	11	12	13	14	15	16
L1		131	156	181	206	231	256	281	306	331	356	381	406	431	456	481	506
L2		164.5	189.5	214.5	239.5	264.5	289.5	314.5	339.5	364.5	389.5	414.5	439.5	464.5	489.5	514.5	539.5

- SV
- SYJ
- SZ
- VF
- VP4
- VQ 1/2
- VQ 4/5
- VQC 1/2
- VQC 4/5
- VQZ
- SQ
- VFS
- VFR
- VQ7

VQC4000 Series

P VQC4000 Kit (Flat ribbon cable kit) IP40 compliant

- Using our flat ribbon cable for electrical connections greatly reduces labour, while it also minimizes wiring and saves space.
- We use flat ribbon cables whose connectors (26P and 20P) conform to MIL standards, and are therefore widely compatible with many standard commercial models.
- Top or side entry for the connector can be changed freely, allowing for changes even after mounting, to meet any changing needs for space.

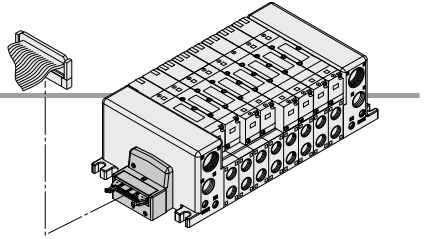

Electrical Wiring Specifications

Flat ribbon cable connector

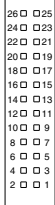

Double wiring (connected to SOL. A and SOL. B) is used for the internal wiring of each station regardless of valve and option types. Mixed single and double wiring are available as options. Refer to special wiring specifications (options) below.

Connector terminal number

Triangle mark indicator position

<26P>

<20P>

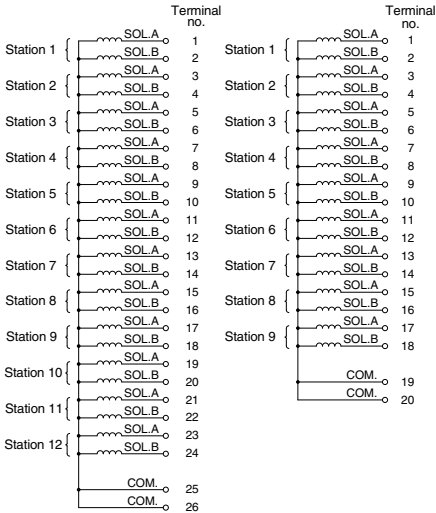

Cable Assembly

AXT100-FC $\begin{matrix} 20 \\ 26 \\ 3 \end{matrix}$

(Type 26P flat ribbon cable connector assemblies can be ordered with manifolds. Refer to manifold ordering.)

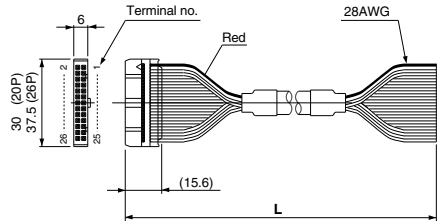

Flat ribbon cable connector assemblies

Cable length [L]	Part no.	
	26P	20P
1.5 m	AXT100-FC26-1	AXT100-FC20-1
3 m	AXT100-FC26-2	AXT100-FC20-2
5 m	AXT100-FC26-3	AXT100-FC20-3

- When using a standard commercial connector, use a type 26P connector conforming to MIL-C-83503 or a type 20P with strain relief.
- Cannot be used for transfer wiring.
- Lengths other than the above is also available. Please contact SMC for details.

Connector Manufacturers Example

- HIROSE ELECTRIC CO., LTD.
- 3M Japan Limited
- Fujitsu, Limited
- Japan Aviation Electronics Industry, Limited
- J.S.T. Mfg. Co., Ltd.
- Oki Electric Cable Co., Ltd.

Special Wiring Specifications (Option)

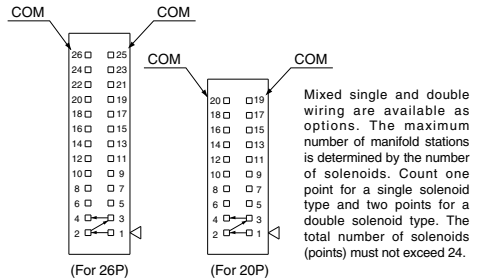

P VQC4000

Kit (Flat ribbon cable kit) IP40 compliant

VV5QC41

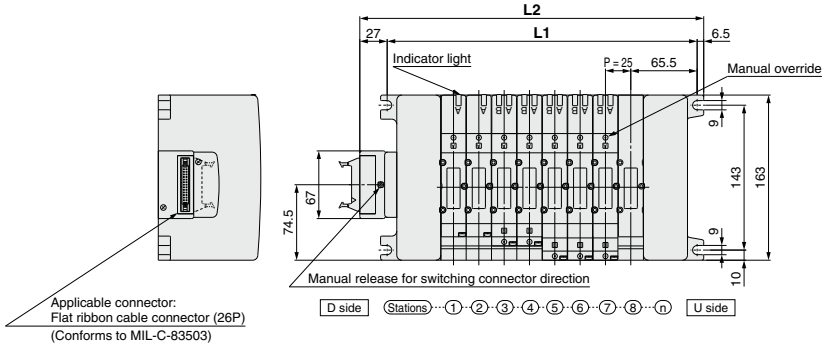

- Flat ribbon cable connector assembly (26P)
- AXT100-FC26-1: 1.5 m
- AXT100-FC26-2: 3 m
- AXT100-FC26-3: 5 m

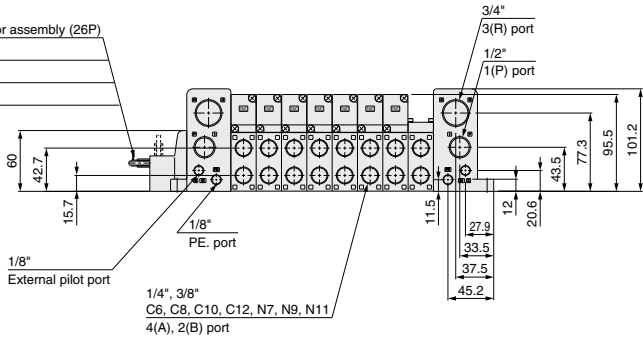

Bottom ported

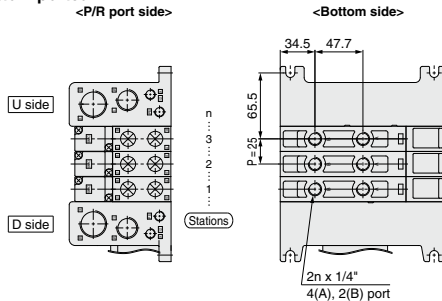

* Other dimensions are the same as the side ported type.

Dimensions

Formula: $L1 = 25n + 106$, $L2 = 25n + 139.5$ n: Stations (Maximum 16 stations)

L	n	1	2	3	4	5	6	7	8	9	10	11	12	13	14	15	16
L1		131	156	181	206	231	256	281	306	331	356	381	406	431	456	481	506
L2		164.5	189.5	214.5	239.5	264.5	289.5	314.5	339.5	364.5	389.5	414.5	439.5	464.5	489.5	514.5	539.5

SV
SYJ
SZ
VF
VP4
VQ 1/2
VQ 4/5
VQC 1/2
VQC 4/5
VQZ
SQ
VFS
VFR
VQ7

VQC4000 Series

T VQC4000 Kit (Terminal block box kit) IP67 compliant

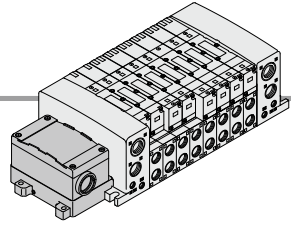

- This kit has a small terminal block inside a junction box. The provision of a G3/4 electrical entry allows connection of conduit fittings.

Terminal Block Connection

Step 1. How to remove terminal block cover

Loosen the 4 mounting screws (M4) and remove the terminal block cover.

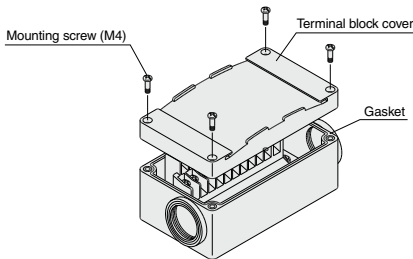

Step 3. How to replace the terminal block cover

Securely tighten the screws to the torque shown in the table below, after confirming that the gasket is installed correctly.

Proper tightening torque [N·m]
0.7 to 1.2

- Applicable crimped terminal: 1.25-3S, 1.25Y-3, 1.25Y-3N, 1.25Y-3.5
- Name plate: VVQ5000-N-T
- Drip proof plug assembly (for G3/4): AXT100-B06A

Step 2. The diagram below shows the terminal block wiring.

All stations are provided with double wiring regardless of the valves which are mounted.

Connect each wire to the power supply side, according to the markings provided inside the terminal block.

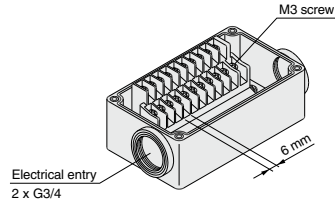

Electrical Wiring Specifications (Conforms to IP67)

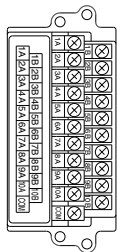

The internal wiring is double (connected to SOL. A and SOL. B) for all stations regardless of the type of valve or options. Mixed single and double wiring are available as options.

Standard wiring

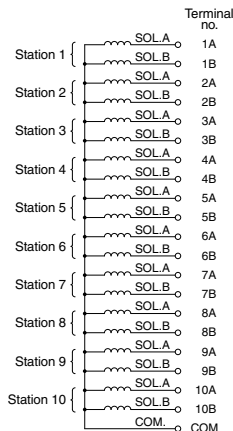

Special Wiring Specifications (Option)

Mixed single and double wiring are available as options. The maximum number of manifold stations is determined by the number of solenoids. Count one point for a single solenoid type and two points for a double solenoid type. The total number of solenoids (points) must not exceed 20.

1. How to Order

Indicate option symbol "K" in the manifold part number and be sure to specify station positions for single or double wiring on the manifold specification sheet.

2. Wiring specifications

Connector terminal numbers are connected from solenoid station 1 on the A side in the order indicated by the arrows without skipping any terminal numbers.

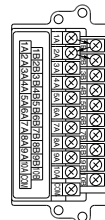

T VQC4000

Kit (Terminal block box kit) IP67 compliant

VV5QC41

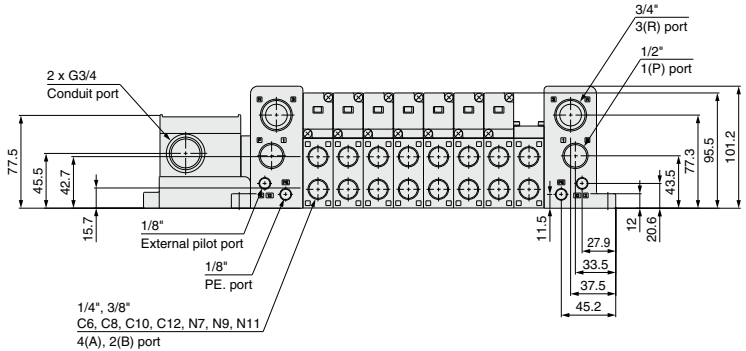
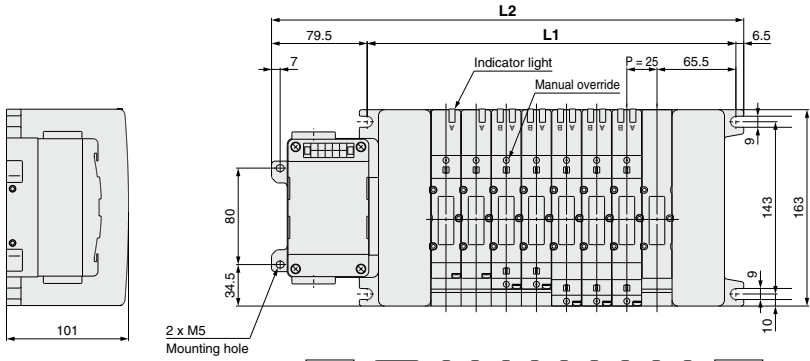

Bottom ported

<P/R port side>

<Bottom side>

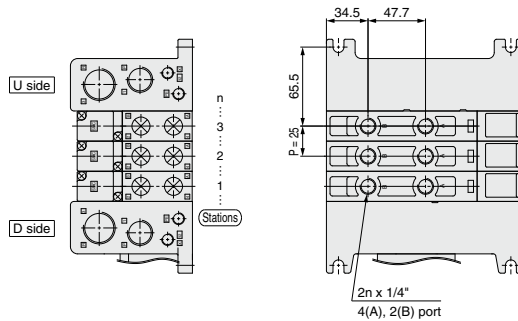

* Other dimensions are the same as the side ported type.

Dimensions

Formula: $L1 = 25n + 106$, $L2 = 25n + 192$ n: Stations (Maximum 16 stations)

n	1	2	3	4	5	6	7	8	9	10	11	12	13	14	15	16
L1	131	156	181	206	231	256	281	306	331	356	381	406	431	456	481	506
L2	217	242	267	292	317	342	367	392	417	442	467	492	517	542	567	592

- SV
- SYJ
- SZ
- VF
- VP4
- VQ 1/2
- VQ 4/5
- VQC 1/2
- VQC 4/5
- VQZ
- SQ
- VFS
- VFR
- VQ7

VQC4000 Series

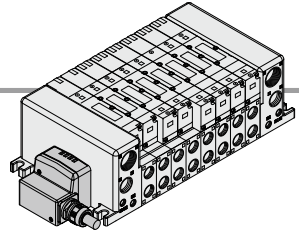

- Direct electrical entry type
- IP67 enclosure is available with use of cables with sheath and waterproof connectors.

Electrical Wiring Specifications

Lead wire specifications

Lead wire

0.3 mm² x 25 cores

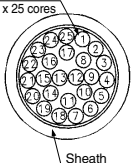

Sheath
Color: Urban white

As the standard electrical wiring specification used is for 12 stations or less, double wiring (connected to SOL. A and SOL. B) is used for the internal wiring of each station regardless of valve and option types.

Mixed single and double wiring are available as options.

Refer to special wiring specifications (options) below.

Lead wire length

VV5QC41-08 C12 LD 0

Lead wire length

0	0.6 m
1	1.5 m
2	3.0 m

Electrical characteristics

Item	Characteristic
Conductor resistance Ω/km, 20°C	65 or less
Withstand pressure V, 1 minute, AC	1000
Insulation resistance MΩ/km, 20°C	5 or more

Note) Cannot be used for transfer wiring.
The minimum bending radius for cables is 20 mm.

Terminal no.	Lead wire color	Dot marking
Station 1 { SOL.A 1	Black	None
Station 1 { SOL.B 14	Yellow	Black
Station 2 { SOL.A 2	Brown	None
Station 2 { SOL.B 15	Pink	Black
Station 3 { SOL.A 3	Red	None
Station 3 { SOL.B 16	Blue	White
Station 4 { SOL.A 4	Orange	None
Station 4 { SOL.B 17	Purple	None
Station 5 { SOL.A 5	Yellow	None
Station 5 { SOL.B 18	Gray	None
Station 6 { SOL.A 6	Pink	None
Station 6 { SOL.B 19	Orange	Black
Station 7 { SOL.A 7	Blue	None
Station 7 { SOL.B 20	Red	White
Station 8 { SOL.A 8	Purple	White
Station 8 { SOL.B 21	Brown	White
Station 9 { SOL.A 9	Gray	Black
Station 9 { SOL.B 22	Pink	Red
Station 10 { SOL.A 10	White	Black
Station 10 { SOL.B 23	Gray	Red
Station 11 { SOL.A 11	White	Red
Station 11 { SOL.B 24	Black	White
Station 12 { SOL.A 12	Yellow	Red
Station 12 { SOL.B 25	White	None
COM 13	Orange	Red

Special Wiring Specifications (Option)

Mixed single and double wiring are available as options. The maximum number of manifold stations is determined by the number of solenoids. Count one point for a single solenoid type and two points for a double solenoid type. The total number of solenoids (points) must not exceed 24.

L **VQC4000**
Kit (Lead wire kit) **IP67 compliant**

VV5QC41

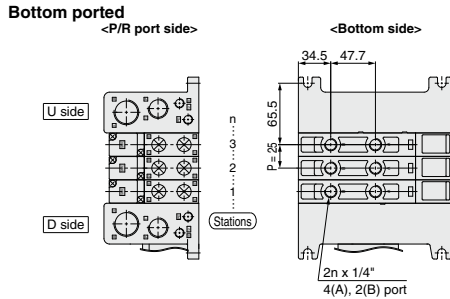
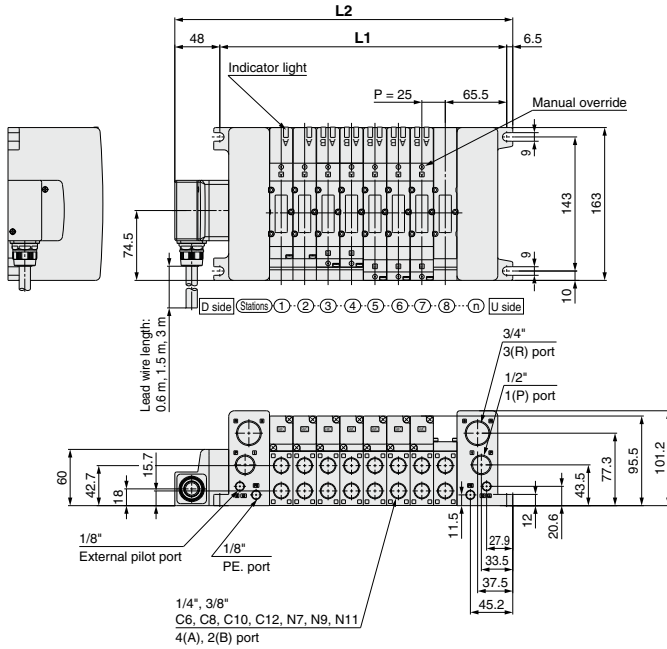

* Other dimensions are the same as the side ported type.

Dimensions

Formula: $L1 = 25n + 106$, $L2 = 25n + 160.5$ n: Stations (Maximum 16 stations)

L	n	1	2	3	4	5	6	7	8	9	10	11	12	13	14	15	16
L1		131	156	181	206	231	256	281	306	331	356	381	406	431	456	481	506
L2		185.5	210.5	235.5	260.5	285.5	310.5	335.5	360.5	385.5	410.5	435.5	460.5	485.5	510.5	535.5	560.5

- SV
- SYJ
- SZ
- VF
- VP4
- VQ 1/2
- VQ 4/5
- VQC 1/2
- VQC 4/5**
- VQZ
- SQ
- VFS
- VFR
- VQ7

VQC4000 Series

M VQC4000 Kit (Circular connector kit) IP67 compliant

- Use of circular connectors helps streamline wiring procedure to save labor.
- IP67 enclosure is available with use of waterproof multiple connectors.

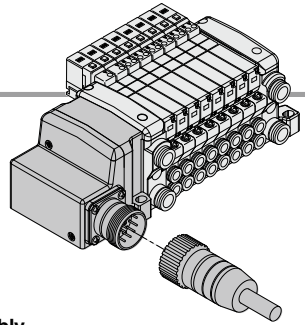

Electrical Wiring Specifications

Multiple connector

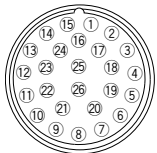

Double wiring (connected to SOL.A and SOL.B) is used for the internal wiring of each station regardless of valve and option types. Mixed single and double wiring are available as options. Refer to special wiring specifications (options) below.

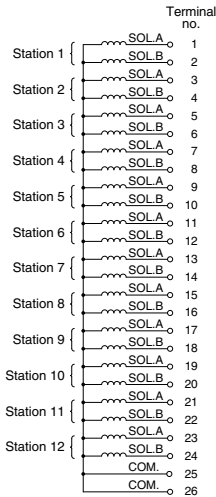

Special Wiring Specifications (Option)

Mixed single and double wiring are available as an option. The maximum number of manifold stations is determined by the number of solenoids. Count one point for a single solenoid type and two points for a double solenoid type. The total number of solenoids (points) must not exceed 24.

Cable Assembly

AXT100-MC26-030
015
050

(Type 26P circular connector cable assemblies can be ordered with manifolds. Refer to manifolds ordering.)

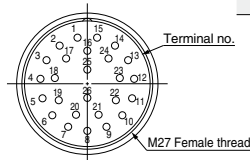
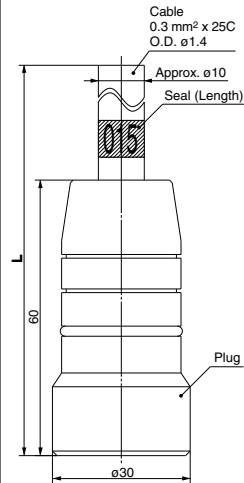

Lead wire colors for circular connector cable assembly terminal numbers

Terminal no.	Lead wire color	Dot marking
1	Black	None
2	Brown	None
3	Red	None
4	Orange	None
5	Yellow	None
6	Pink	None
7	Blue	None
8	Purple	White
9	Gray	Black
10	White	Black
11	White	Red
12	Yellow	Red
13	Orange	Red
14	Yellow	Black
15	Pink	Black
16	Blue	White
17	Purple	None
18	Gray	None
19	Orange	Black
20	Red	White
21	Brown	White
22	Pink	Red
23	Gray	Red
24	Black	White
25	White	None
26	White	None

Electric characteristics

Item	Property
Conductor resistance Ω/km, 20°C	65 or less
Voltage limit V _i , 1 minute, AC	1000
Insulation resistance MΩ/km, 20°C	5 or more

(Note) The minimum bending radius of the multiple connector cable is 20 mm.

Circular connector cable assemblies

Cable length [L]	Assembly part no.
	26P
1.5 m	AXT100-MC26-015
3 m	AXT100-MC26-030
5 m	AXT100-MC26-050

- * Cannot be used for transfer wiring.
- * Lengths other than the above is also available. Please contact SMC for details.



VQC4000

Kit (Circular connector kit) IP67 compliant

VV5QC41

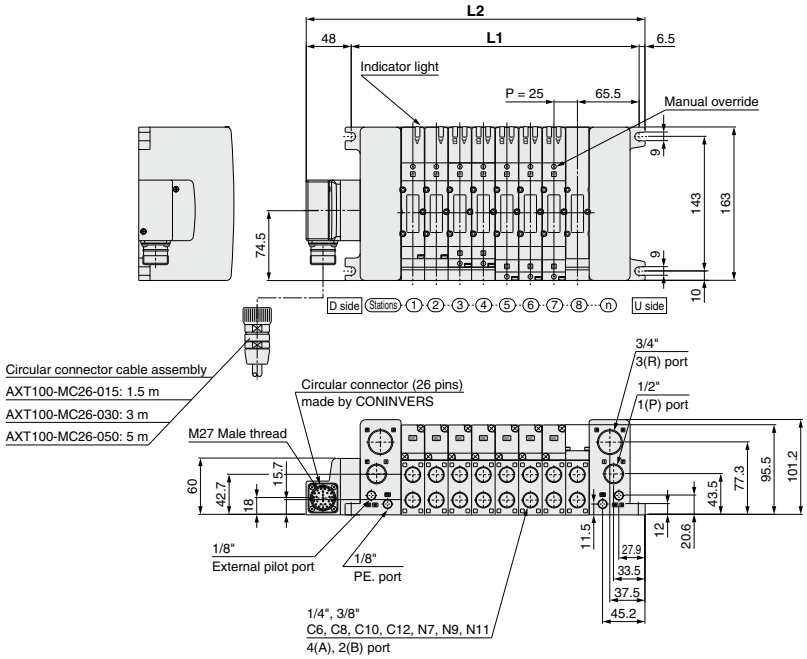

Bottom ported

<P/R port side>

<Bottom side>

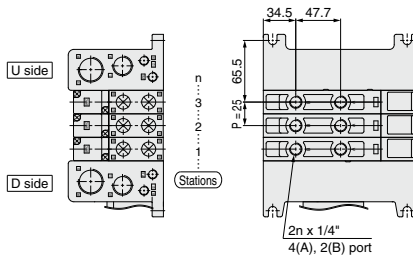

* Other dimensions are the same as the side ported type.

Dimensions

Formula: L1 = 25n + 106, L2 = 25n + 150.5 n: Stations (Maximum 16 stations)

n	1	2	3	4	5	6	7	8	9	10	11	12	13	14	15	16
L1	131	156	181	206	231	256	281	306	331	356	381	406	431	456	481	506
L2	185.5	210.5	235.5	260.5	285.5	310.5	335.5	360.5	385.5	410.5	435.5	460.5	485.5	510.5	535.5	560.5

SV
SYJ
SZ
VF
VP4
VQ 1/2
VQ 4/5
VQC 1/2
VQC 4/5
VQZ
SQ
VFS
VFR
VQ7

VQC4000 Series

Exploded View of Manifold

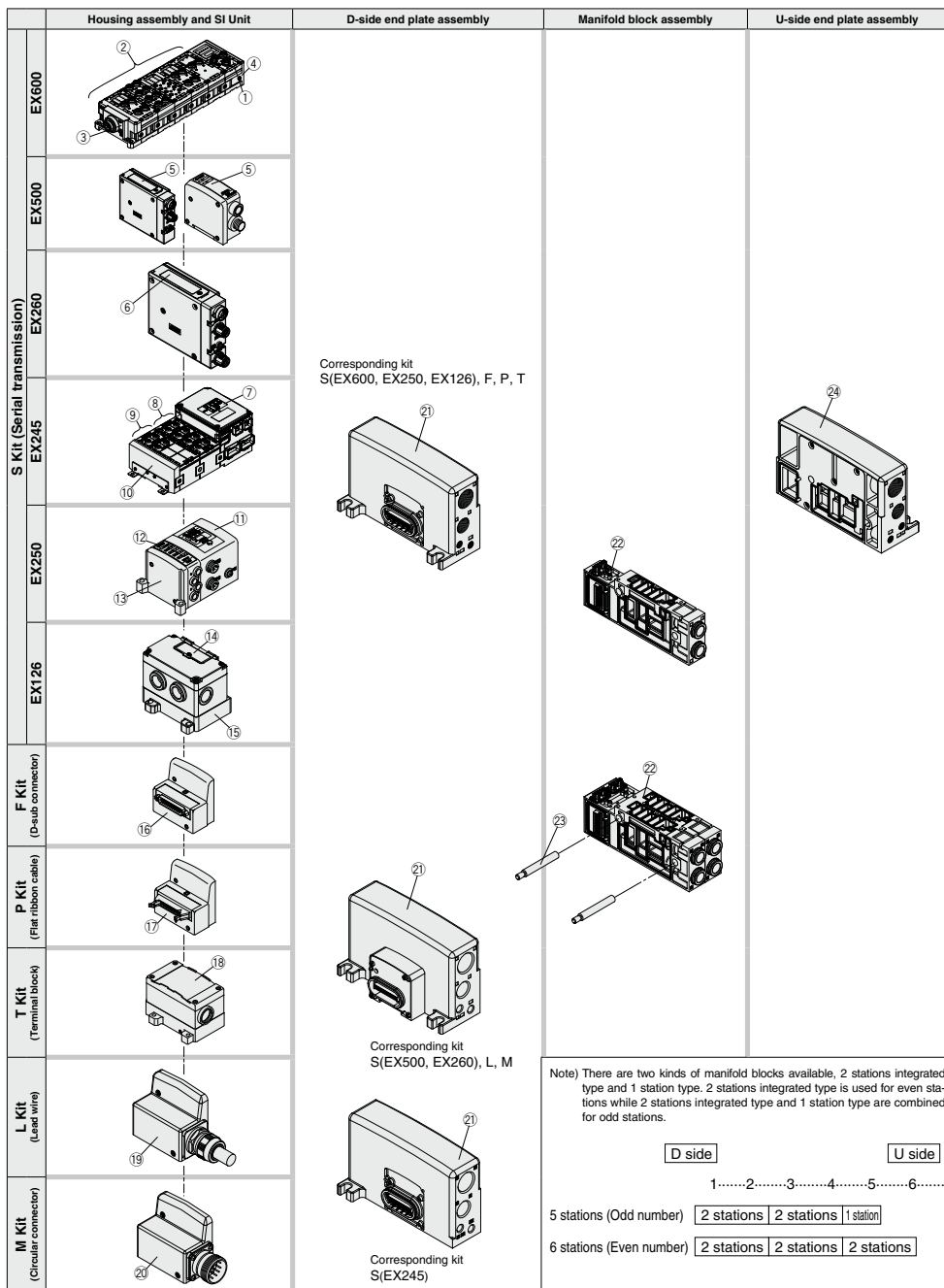

- SV
- SYJ
- SZ
- VF
- VP4
- VQ 1/2
- VQ 4/5
- VQC 1/2
- VQC 4/5
- VQZ
- SQ
- VFS
- VFR
- VQ7

VQC4000 Series

Manifold Assembly Part No.

Housing Assembly and SI Unit/Input Block

No.	Description	Part no.	Note
①	SI Unit	EX600-SDN1A	DeviceNet™, Negative common (PNP)
		EX600-SDN2A	DeviceNet™, Positive common (NPN)
		EX600-SMJ1	CC-Link, Negative common (PNP)
		EX600-SMJ2	CC-Link, Positive common (NPN)
		EX600-SPR1A	PROFIBUS DP, Negative common (PNP)
		EX600-SPR2A	PROFIBUS DP, Positive common (NPN)
		EX600-SEN1	EtherNet/IP™ (1 port), Negative common (PNP)
		EX600-SEN2	EtherNet/IP™ (1 port), Positive common (NPN)
		EX600-SEN3	EtherNet/IP™ (2 port), Negative common (PNP)
		EX600-SEN4	EtherNet/IP™ (2 port), Positive common (NPN)
		EX600-SPN1	PROFINET, Negative common (PNP)
		EX600-SPN2	PROFINET, Positive common (NPN)
		EX600-SEC1	EtherCAT, Negative common (PNP)
		EX600-SEC2	EtherCAT, Positive common (NPN)
		EX600-WEN1 ^{Note)}	Wireless base module EtherNet/IP™ Negative common (PNP)
		EX600-WEN2 ^{Note)}	Wireless base module EtherNet/IP™ Positive common (NPN)
		EX600-WPN1 ^{Note)}	Wireless base module PROFINET Negative common (PNP)
		EX600-WPN2 ^{Note)}	Wireless base module PROFINET Positive common (NPN)
		EX600-WSV1 ^{Note)}	Wireless remote module Negative common (PNP)
		EX600-WSV2 ^{Note)}	Wireless remote module Positive common (NPN)
②	Digital Input Unit	EX600-DXNB	NPN input, M12 connector, 5 pins (4 pcs.), 8 inputs
		EX600-DXPB	PNP input, M12 connector, 5 pins (4 pcs.), 8 inputs
		EX600-DXNC	NPN input, M8 connector, 3 pins (8 pcs.), 8 inputs
		EX600-DXNC1	NPN input, M8 connector, 3 pins (8 pcs.), 8 inputs, with open circuit detection
		EX600-DXPC	PNP input, M8 connector, 3 pins (8 pcs.), 8 inputs
		EX600-DXPC1	PNP input, M8 connector, 3 pins (8 pcs.), 8 inputs, with open circuit detection
		EX600-DXND	NPN input, M12 connector, 5 pins (8 pcs.), 16 inputs
		EX600-DXPD	PNP input, M12 connector, 5 pins (8 pcs.), 16 inputs
		EX600-DXNE	NPN input, D-sub connector, 25 pins, 16 inputs
		EX600-DXPE	PNP input, D-sub connector, 25 pins, 16 inputs
	EX600-DXNF	NPN input, Spring type terminal box, 32 pins, 16 inputs	
	EX600-DXPF	PNP input, Spring type terminal box, 32 pins, 16 inputs	
	Digital Output Unit	EX600-DYNB	NPN output, M12 connector, 5 pins (4 pcs.), 8 outputs
		EX600-DYPB	PNP output, M12 connector, 5 pins (4 pcs.), 8 outputs
		EX600-DYNE	NPN output, D-sub connector, 25 pins, 16 outputs
		EX600-DYPE	PNP output, D-sub connector, 25 pins, 16 outputs
		EX600-DYNF	NPN output, Spring type terminal box, 32 pins, 16 outputs
		EX600-DYPF	PNP output, Spring type terminal box, 32 pins, 16 outputs
	Digital Input/Output Unit	EX600-DMNE	NPN input/output, D-sub connector, 25 pins, 8 inputs/outputs
		EX600-DMPE	PNP input/output, D-sub connector, 25 pins, 8 inputs/outputs
EX600-DMNF		NPN input/output, Spring type terminal box, 32 pins, 8 inputs/outputs	
	EX600-DMPF	PNP input/output, Spring type terminal box, 32 pins, 8 inputs/outputs	
Analog Input Unit		EX600-AXA	M12 connector, 5 pins (2 pcs.), 2-channel input
Analog Output Unit		EX600-AYA	M12 connector, 5 pins (2 pcs.), 2-channel output
Analog Input/Output Unit		EX600-AMB	M12 connector, 5 pins (4 pcs.), 2-channel input/output
③	End plate	EX600-ED2	M12 power supply connector, B-coded
		EX600-ED3	7/8 inch power supply connector
		EX600-ED4	M12 power supply connector IN/OUT, A-coded, Pin arrangement 1
		EX600-ED5	M12 power supply connector IN/OUT, A-coded, Pin arrangement 2
④	Valve plate	EX600-ZMV1	Enclosed parts: Round head screws (M4 x 6) 2 pcs., Round head screws (M3 x 8) 4 pcs.
⑤	SI Unit	EX500-S103	EtherNet/IP™, PROFINET, Negative common (PNP)
		EX500-Q001	DeviceNet™, PROFIBUS DP, EtherNet/IP™, Positive common (NPN)
		EX500-Q101	DeviceNet™, PROFIBUS DP, EtherNet/IP™, Negative common (PNP)

Note) The wireless system is suitable for use only in a country where it is in accordance with the Radio Act and regulations of that country.

Manifold Assembly Part No.

Housing Assembly and SI Unit/Input Block

No.	Description	Part no.	Note
⑥	SI Unit	EX260-SDN1	DeviceNet™, M12 connector, 32 outputs, Negative common (PNP)
		EX260-SDN2	DeviceNet™, M12 connector, 32 outputs, Positive common (NPN)
		EX260-SDN3	DeviceNet™, M12 connector, 16 outputs, Negative common (PNP)
		EX260-SDN4	DeviceNet™, M12 connector, 16 outputs, Positive common (NPN)
		EX260-SRP1	PROFIBUS DP, M12 connector, 32 outputs, Negative common (PNP)
		EX260-SRP2	PROFIBUS DP, M12 connector, 32 outputs, Positive common (NPN)
		EX260-SRP3	PROFIBUS DP, M12 connector, 16 outputs, Negative common (PNP)
		EX260-SRP4	PROFIBUS DP, M12 connector, 16 outputs, Positive common (NPN)
		EX260-SRP5	PROFIBUS DP, D-sub connector, 32 outputs, Negative common (PNP)
		EX260-SRP6	PROFIBUS DP, D-sub connector, 32 outputs, Positive common (NPN)
		EX260-SRP7	PROFIBUS DP, D-sub connector, 16 outputs, Negative common (PNP)
		EX260-SRP8	PROFIBUS DP, D-sub connector, 16 outputs, Positive common (NPN)
		EX260-SMJ1	CC-Link, M12 connector, 32 outputs, Negative common (PNP)
		EX260-SMJ2	CC-Link, M12 connector, 32 outputs, Positive common (NPN)
		EX260-SMJ3	CC-Link, M12 connector, 16 outputs, Negative common (PNP)
		EX260-SMJ4	CC-Link, M12 connector, 16 outputs, Positive common (NPN)
		EX260-SEC1	EtherCAT, M12 connector, 32 outputs, Negative common (PNP)
		EX260-SEC2	EtherCAT, M12 connector, 32 outputs, Positive common (NPN)
		EX260-SEC3	EtherCAT, M12 connector, 16 outputs, Negative common (PNP)
		EX260-SEC4	EtherCAT, M12 connector, 16 outputs, Positive common (NPN)
		EX260-SPN1	PROFINET, M12 connector, 32 outputs, Negative common (PNP)
		EX260-SPN2	PROFINET, M12 connector, 32 outputs, Positive common (NPN)
		EX260-SPN3	PROFINET, M12 connector, 16 outputs, Negative common (PNP)
		EX260-SPN4	PROFINET, M12 connector, 16 outputs, Positive common (NPN)
		EX260-SEN1	EtherNet/IP™, M12 connector, 32 outputs, Negative common (PNP)
		EX260-SEN2	EtherNet/IP™, M12 connector, 32 outputs, Positive common (NPN)
		EX260-SEN3	EtherNet/IP™, M12 connector, 16 outputs, Negative common (PNP)
		EX260-SEN4	EtherNet/IP™, M12 connector, 16 outputs, Positive common (NPN)
		EX260-SPL1	Ethernet POWERLINK, M12 connector, 32 outputs, Negative common (PNP)
		EX260-SPL3	Ethernet POWERLINK, M12 connector, 16 outputs, Negative common (PNP)
		EX260-SIL1	IO-Link, M12 connector, 32 outputs, Negative common (PNP)
		⑦	SI unit
EX245-SPN2A	Communication connector: Push Pull connector (RJ45); 2 pcs./Power supply connector: Push Pull connector (24 V); 2 pcs.		
EX245-SPN3A	Communication connector: M12 connector (4-pin, Socket, D-coded); 2 pcs./Power supply connector: 7/8 inch connector (5-pin, Plug); 1 pc. 7/8 inch connector (5-pin, Socket); 1 pc.		
⑧	Digital input module	EX245-DX1	Digital input (16 inputs)
⑨	Digital output module	EX245-DY1	Digital output (16 outputs)
⑩	End plate	EX245-EA2-4	
⑪	SI Unit	EX250-SPR1	PROFIBUS DP, Negative common (PNP)
		EX250-SAS3	AS-Interface, 8 in/8 out, 31 slave modes, 2 power supply systems, Negative common (PNP)
		EX250-SAS5	AS-Interface, 4 in/4 out, 31 slave modes, 2 power supply systems, Negative common (PNP)
		EX250-SAS7	AS-Interface, 8 in/8 out, 31 slave modes, 1 power supply system, Negative common (PNP)
		EX250-SAS9	AS-Interface, 4 in/4 out, 31 slave modes, 1 power supply system, Negative common (PNP)
		EX250-SCA1A	CANopen, Negative common (PNP)
		EX250-SDN1	DeviceNet™, Negative common (PNP)
		EX250-SEN1	EtherNet/IP™, Negative common (PNP)
⑫	Input block	EX250-IE1	M12, 2 inputs
		EX250-IE2	M12, 4 inputs
		EX250-IE3	M8, 4 inputs
⑬	End plate assembly	EX250-EA1	Direct mounting
		EX250-EA2	DIN rail mounting
⑭	SI Unit	EX126D-SMJ1	CC-Link, Positive common (NPN)
⑮	Terminal block plate	VVQC1000-74A-2	For EX126 SI Unit mounting
⑯	D-sub connector housing assembly	VVQC1000-F25-1	F kit, 25 pins
⑰	Flat ribbon cable housing assembly	VVQC1000-P26-1	P kit, 26 pins
		VVQC1000-P20-1	P kit, 20 pins
⑱	Terminal block box housing assembly	VVQC1000-T0-1	T kit
		VVQC1000-L25-0-1	L kit with 0.6 m lead wire
⑲	Lead wire housing assembly	VVQC1000-L25-1-1	L kit with 1.5 m lead wire
		VVQC1000-L25-2-1	L kit with 3.0 m lead wire
		VVQC1000-M26-1	M kit, 26 pins
⑳	Circular connector housing assembly	VVQC1000-M26-1	M kit, 26 pins

SV

SYJ

SZ

VF

VP4

VQ

1/2

VQ

4/5

VQC

1/2

VQC

4/5

VQZ

SQ

VFS

VFR

VQ7

VQC4000 Series

Manifold Assembly Part No.

D-side end plate assembly

② D-side end plate assembly part no.

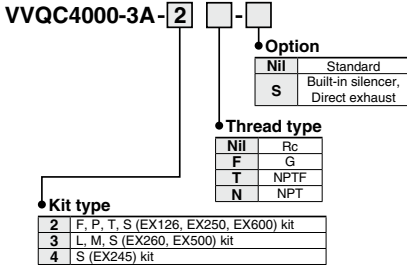

U-side end plate assembly

④ U-side end plate assembly part no.

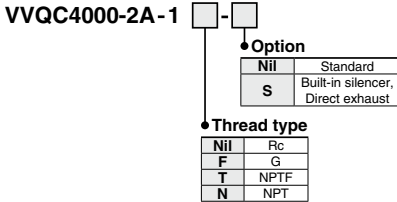

Manifold block assembly

② Manifold block assembly part no.

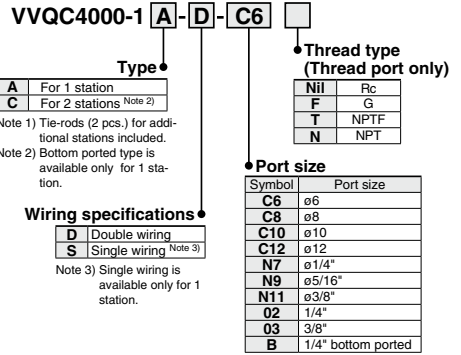

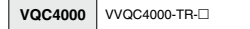

③ Tie-rod assembly part no. (2 units)



Note 1) Please order when reducing the number of manifold stations. When increasing the number of stations, additional orders are not required since they are included in the manifold block assembly.

Note 2) Number of stations, 02 to 16

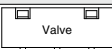
List of Valves, Options, and Mounting Bolts

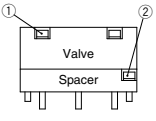
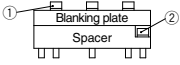
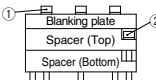
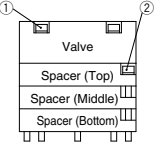
Number of options	Valve and options	Bolt part no.	Qty (pcs)	Note	Option mounting diagram	
0	Single valve	AXT632-17-4 (M3 x 37)	3			
	Blanking plate (VVQ4000-10A- $\frac{1}{2}$)	AXT632-38-1 (M3 x 14)	4	For manifold		
1	Valve + Individual SUP spacer (VVQ4000-P- $\frac{1}{2}$ - $\frac{3}{8}$)	① AXT632-17-10 (M3 x 62) ② AXT632-17-19 (M3 x 26)	3 2	For manifold		
	Valve + Individual EXH spacer (VVQ4000-R- $\frac{1}{2}$ - $\frac{3}{8}$)	① AXT632-17-10 (M3 x 62) ② AXT632-17-19 (M3 x 26)	3 2	For manifold		
	Valve + Restrictor spacer (VVQ4000-20A- $\frac{1}{2}$)	① AXT632-17-10 (M3 x 62) ② AXT632-17-19 (M3 x 26)	3 2	Not necessary when mounting the sub-plate.		
	Valve + Release valve spacer (VVQ4000-24A- $\frac{1}{2}$ D)	① AXT632-17-10 (M3 x 62) ② AXT632-17-19 (M3 x 26)	3 2	For manifold		
	Valve + SUP stop valve spacer (VVQ4000-37A- $\frac{1}{2}$)	① AXT632-17-10 (M3 x 62) ② AXT632-17-19 (M3 x 26)	3 2	Not necessary when mounting the sub-plate.		
	Valve + Double check spacer with residual pressure exhaust (VVQ4000-25A- $\frac{1}{2}$)	① AXT632-17-11 (M3 x 87) ② AXT632-41-1 (M3 x 54)	3 2	Not necessary when mounting the sub-plate.		
	Valve + Interface regulator (ARBQ4000-00 \hat{A} - $\frac{1}{2}$)	① AXT632-17-11 (M3 x 87) ② AXT632-17-8 (M3 x 52)	3 2	Not necessary when mounting the sub-plate.		
	Blanking plate + SUP stop valve (Top) (Bottom)	① AXT632-41-4 (M3 x 42) ② AXT632-17-19 (M3 x 26)	3 2	For manifold		
	2	Valve + Individual SUP + Individual EXH (Top) (Bottom) (Bottom) (Top)	① AXT632-17-11 (M3 x 87) ② AXT632-17-8 (M3 x 52)	3 2		For manifold
Valve + Restrictor + Individual SUP or Individual EXH (Top) (Bottom) (Top) (Bottom)		① AXT632-17-11 (M3 x 87) ② AXT632-17-8 (M3 x 52)	3 2	For manifold The individual EXH cannot be mounted on the top.		
Valve + SUP stop valve + Individual SUP, Individual EXH or Restrictor (Top) (Bottom)		① AXT632-17-11 (M3 x 87) ② AXT632-17-8 (M3 x 52)	3 2	For manifold		
Valve + Double check spacer with residual pressure exhaust (Top) (Bottom) + Individual SUP or Individual EXH (Top) (Bottom)		① AXT632-17-14 (M3 x 112) ② AXT632-41-2 (M3 x 78)	3 2	For manifold		
Valve + Interface regulator + Individual SUP, Individual EXH or Restrictor (Top) (Bottom)		① AXT632-17-14 (M3 x 112) ② AXT632-41-2 (M3 x 78)	3 2	For manifold The individual EXH and restrictor can be mounted on the top.		
Valve + Double check spacer with residual pressure exhaust (Bottom) + Interface regulator (Top)		① AXT632-17-16 (M3 x 137) ② AXT632-41-3 (M3 x 103)	3 2	For manifold		
Blanking plate + SUP stop valve + Individual SUP (Top) (Bottom)		① AXT632-17-17 (M3 x 66) ② AXT632-17-8 (M3 x 52)	3 2	For manifold		
3	Valve + SUP stop valve (Top) + Individual SUP (Middle, Bottom) + Individual EXH (Middle, Bottom)	① AXT632-17-14 (M3 x 112) ② AXT632-17-13 (M3 x 77)	3 2	For manifold		
	Valve + Double check spacer with residual pressure exhaust (Top) + Individual SUP (Middle, Bottom) + Individual EXH (Middle, Bottom)	① AXT632-17-16 (M3 x 137) ② AXT632-41-3 (M3 x 103)	3 2	For manifold		
	Valve + Spacer (Top): Interface regulator Spacer (Middle): "Individual SUP or Individual EXH"/Restrictor Spacer (Bottom): "Restrictor"/Individual SUP or Individual EXH	① AXT632-17-16 (M3 x 137) ② AXT632-41-3 (M3 x 103)	3 2	For manifold The individual EXH and restrictor can be mounted on the top.		
Valve + Double check spacer with residual pressure exhaust (Top) + SUP stop valve (Middle) + Individual SUP (EXH) (Bottom)	① AXT632-17-16 (M3 x 137) ② AXT632-41-3 (M3 x 103)	3 2	For manifold			
Valve + Interface regulator (Top) + Double check spacer with residual pressure exhaust (Middle) + Individual SUP (EXH) (Bottom)	① AXT632-17-20 (M3 x 162) ② AXT632-41-5 (M3 x 128)	3 2	For manifold available as special order			

Note) When the SUP stop valve and individual SUP are mounted, the stop valve is mounted on the top of the individual SUP.

SV
SYJ
SZ
VF
VP4
VQ 1/2
VQ 4/5
VQC 1/2
VQC 4/5
VQZ
SQ
VFS
VFR
VQ7



VQC4000 Series

Specific Product Precautions 1

Be sure to read this before handling the products.

Refer to back page 50 for Safety Instructions and pages 3 to 9 for 3/4/5 Port Solenoid Valve Precautions.

Continuous Duty

⚠ Warning

When the product is continuously energized for a long period of time (10 minutes or longer), select the low wattage type (DC specification). The AC type cannot be continuously energized for 10 minutes or longer. If anything is unclear, please contact SMC.

Manual Override

⚠ Warning

Since connected equipment will operate when the manual override is activated, confirm that conditions are safe prior to activation.

■ VQC4000

Push type (Tool required)

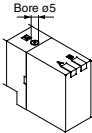

Push down the manual override button with a small screwdriver, etc., until it stops. The manual override will return when released.

Locking type (Tool required)

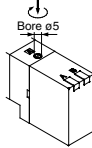

Push down the manual override button with a small flat head screwdriver until it stops, and turn it clockwise 90° to lock it. Turn it counterclockwise to release it.

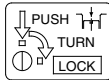

Locking type (Manual)

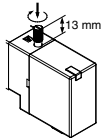

Push down the manual override button with a small flat head screwdriver or with your finger until it stops, and turn it clockwise 90° to lock it. Turn it counterclockwise to release it.

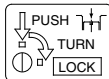

⚠ Caution

Do not apply excessive torque when turning the locking type manual override. (0.1 N·m or less)

Valve Mounting

⚠ Caution

After confirming that the gasket is installed correctly, securely tighten the mounting screws according to the tightening torque shown below.

Proper tightening torque [N·m]
0.8 to 1.2

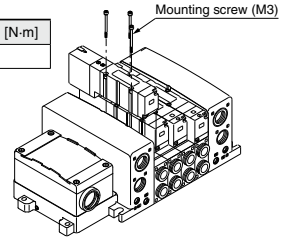

Replacement of One-touch Fittings

⚠ Caution

Cylinder port fittings are available in cassette type and can be replaced easily. Fittings are secured with a retaining clip that is inserted from the top side of the valve. After removing the valve, remove the clip with a flat head screwdriver to replace the fittings. To mount a fitting, insert the fitting assembly until it stops and reinsert the retaining clip to its designated position.

Applicable tube O.D.	Fitting assembly part no.
	VQC4000
ø6	VVQ4000-50B-C6
ø8	VVQ4000-50B-C8
ø10	VVQ4000-50B-C10
ø12	VVQ4000-50B-C12
ø1/4"	VVQ4000-50B-N7
ø5/16"	VVQ4000-50B-N9
ø3/8"	VVQ4000-50B-N11

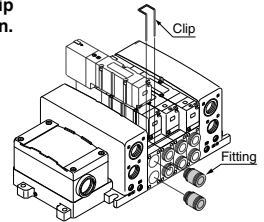

Lead Wire Connection

⚠ Caution

Plug-in sub-plate (With terminal block)

- If the junction cover ① of the sub-plate is removed, you can see the plug-in type terminal block ② mounted inside the sub-plate.
- The terminal block is marked as follows. Connect wiring to each of the power supply terminals.

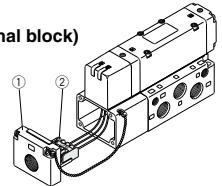

Model	Terminal block marking	A	COM	B	T
VQC 1/2 10 0		A side	COM	—	—
VQC 1/2 20 0		A side	COM	B side	—
VQC 3/4 0 0		A side	COM	B side	—

Note 1) There is no polarity. It can also be used as -COM.

Note 2) The sub-plate is double wired even for the VQC 1/2 10 0.

- Applicable terminal: 1.25-3s, 1.25Y-3, 1.25Y-3N, 1.25Y-3.5



VQC4000 Series Specific Product Precautions 2

Be sure to read this before handling the products.
Refer to back page 50 for Safety Instructions and pages 3 to 9 for 3/4/5 Port Solenoid Valve Precautions.

Installation and Removal of Light Cover

⚠ Caution

Installation/Removal of light cover

• Removal

Open the cover by inserting a small flat head screwdriver into the slot on the side of the pilot assembly (see drawing below), lift the cover out about 1 mm and then pull off. If it is pulled off at an angle, the pilot valve may be damaged or the protective O-ring may be scratched.

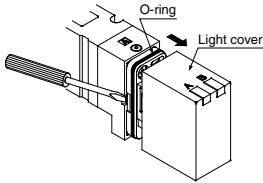

• Installation

Place the cover straight over the pilot assembly so that the pilot valve is not touched, and push it until the cover hook locks without twisting the protective O-ring. (When pushed in, the hook opens and locks automatically.)

Replacement of Pilot Valve

⚠ Caution

• Removal

- 1) Remove the mounting screw that holds the pilot valve using a small screwdriver.

• Installation

- 1) After confirming the gasket is correctly placed under the valve, securely tighten the bolts with the proper torque shown in the table below.

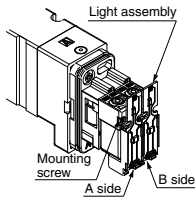

* Refer to page 636 for pilot valve assembly part number.

Proper tightening torque [N·m]

0.1 to 0.13

Note) The light circuit boards: A side is orange and the B side is green. It must be mounted on the pilot valve in accordance with the mounting indicators.

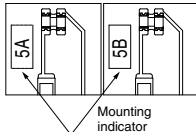

Internal Wiring Specifications

⚠ Caution

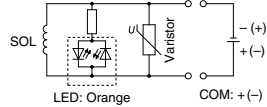

DC: Single

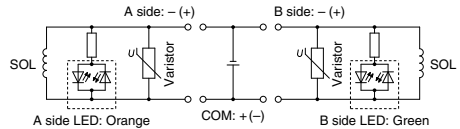

DC: Double

Note) Coil surge voltage generated when OFF is about -60 V. Please contact SMC separately for further suppression of the coil surge voltage.

How to Calculate the Flow Rate

For obtaining the flow rate, refer to flont matter.

SV
SYJ
SZ
VF
VP4
VQ 1/2
VQ 4/5
VQC 1/2
VQC 4/5
VQZ
SQ
VFS
VFR
VQ7



VQC4000 Series

Specific Product Precautions 3

Be sure to read this before handling the products.

Refer to back page 50 for Safety Instructions and pages 3 to 9 for 3/4/5 Port Solenoid Valve Precautions.

Serial Wiring EX500/EX260/EX250/EX126 Precautions

Warning

1. These products are intended for use in general factory automation equipment.
Avoid using these products in machinery/equipment which affects human safety, and in cases where malfunction or failure can result in extensive damage.
2. Do not use in explosive environments, in the presence of inflammable gases, or in corrosive environments. This can cause injury or fire.
3. Work such as transporting, installing, piping, wiring, operation, control and maintenance should be performed by knowledgeable and qualified personnel only. As handling involves the risk of a danger of electrocution, injury or fire.
4. Install an external emergency stop circuit that can promptly stop operation and shut off the power supply.
5. Do not modify these products. Modifications done to these products carry the risk of injury and damage.

Caution

1. Read the Operation Manual carefully, strictly observe the precautions and operate within the range of the specifications.
2. Do not drop these products or submit them to strong impacts. This can cause damage, failure or malfunction.
3. In locations with poor electrical conditions, take steps to ensure a steady flow of the rated power supply. Use of a voltage outside of the specifications can cause a malfunction, damage to the Unit, electrocution or fire.
4. Do not touch connector terminals or internal circuit elements when current is being supplied. There is a danger of malfunction, damage to the Unit or electrocution if connector terminals or internal circuit elements are touched when current is being supplied.
Be sure that the power supply is OFF when adding or removing manifold valves or input blocks or when connecting or disconnecting connectors.
5. Operate at an ambient temperature that is within the specifications. Even when the ambient temperature range is within the specifications, do not use in locations where there are rapid temperature changes.
6. Keep wire scraps and other extraneous materials from getting inside these products. This can cause fire, failure or malfunction.
7. Give consideration to the operating environment depending on the type of enclosure being used.
To achieve IP67 protection, provide appropriate wiring between all Units using electrical wiring cables, communication connectors and cables with M12 connectors. Also, provide waterproof caps when there are unused ports, and perform proper mounting of Input Units, input blocks, SI Units and manifold valves. Provide a cover or other protection for applications in which there is constant exposure to water.
8. Use the proper tightening torques.
There is a possibility of damaging threads if tightening exceeds the tightening torque range.
9. Provide adequate protection when operating in locations such as the following:
 - Where noise is generated by static electricity
 - Where there is a strong electric field
 - Where there is a danger of exposure to radiation
 - When in close proximity to power supply lines

Caution

10. When these products are installed in equipment, provide adequate protection against noise by using noise filters.
11. Since these products are components whose end usage is obtained after installation in other equipment, the customer should confirm conformity to EMC directives for the finished product.
12. Do not remove the name plate.
13. Perform periodic inspections and confirm normal operation, otherwise it may be impossible to guarantee safety due to unexpected malfunction or erroneous operation.
14. Take great care since the SI Unit side surface of the EX260-SPN□ may become hot, causing burn hazard.
15. Do not use in places where there are cyclic temperature changes.
In case that the cyclic temperature is beyond normal temperature changes, the inside product unit is likely to be adversely effected.
16. Do not use in direct sunlight.
Do not use in direct sunlight. It may cause malfunction or damage.
17. Do not use in places where there is radiated heat around it.
Such a place is likely to cause malfunction.

Power Supply Safety Instructions

Caution

1. Operation is possible with a single power supply or a separate power supply. However, be sure to provide two wiring systems (one for solenoid valves, and one for Input and Control Units). When it is UL compliant, use a class 2 power supply unit in accordance with UL1310 for a combined direct current power supply.
2. Select the proper type of enclosure according to the environment of operation.
IP65/67 protection class is achieved when the following conditions are met.
 - 1) The Units are connected properly with wiring cable for power supply, communication connector, and cable with M12 connector.
 - 2) Suitable mounting of each Unit and manifold valve.
 - 3) Be sure to mount a seal cap on any unused connectors.
 If using in an environment that is exposed to water splashes, please take measures such as using a cover.
For IP40 protection class, do not use in atmospheres with corrosive gas, chemicals, sea water, water, steam, or where there is direct contact with any of these.
When EX260-SPR5/6/7/8 are connected, the enclosure of the manifold should be IP40.

Cable Safety Instructions

Caution

1. Avoid miswiring, as this can cause a malfunction, damage and fire in the Unit.
2. To prevent noise and surge in signal lines, keep all wiring separate from power lines and high voltage lines. Otherwise, this can cause a malfunction.
3. Check wiring insulation, as defective insulation can cause damage to the Unit when excessive voltage or current is applied.
4. Do not bend or pull cables repeatedly, and do not place heavy objects on them or allow them to be pinched. This can cause broken lines.



VQC4000 Series

Specific Product Precautions 4

Be sure to read this before handling the products.

Refer to back page 50 for Safety Instructions and pages 3 to 9 for 3/4/5 Port Solenoid Valve Precautions.

EX600 Precautions

Design / Selection

Warning

- Do not use beyond the specification range.**
Using beyond the specification range can cause a fire, malfunction, or damage to the system.
Check the specifications before operation.
- When using for an interlock circuit:**
 - Provide a multiple interlock system which is operated by another system (such as mechanical protection function).
 - Perform an inspection to confirm that it is working properly.

Otherwise, this may cause possible injuries due to malfunction.

Caution

- When applicable to UL, use a Class 2 power supply unit conforming to UL1310 for direct current power supply.**
- Use within the specified voltage range.**
Using beyond the specified voltage range is likely to cause the product to be damaged or to malfunction.
- The power supply for the unit should be 0 V as the standard for both power supply for output as well as power supply for control/input.**

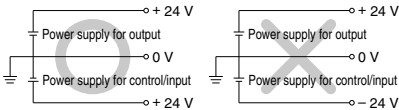

- Do not install in places where it can be used as a foothold.**
Applying any excessive load such as stepping on the product by mistake or placing a foot on it, will cause it to break.
- Keep the surrounding space free for maintenance.**
When designing a system, take into consideration the amount of free space needed for performing maintenance.
- Do not remove the name plate.**
Improper maintenance or incorrect use of Operation Manual can cause equipment failure or malfunction. Also, there is a risk of losing conformity with safety standards.
- Beware of inrush current when the power supply is turned on.**
Some connected loads can apply an initial charge current which will trigger the over current protection function, causing the Unit to malfunction.

Mounting

Caution

- When handling and assembling Units:**
 - Do not touch the sharp metal parts of the connector or plug.
 - Do not apply excessive force to the Unit when disassembling.
The connecting portions of the Unit are firmly joined with seals.
 - When joining Units, take care not to get fingers caught between Units.
Injury can result.
- Do not drop, bump, or apply excessive impact.**
Otherwise, this can cause damage, equipment failure or malfunction.
- Observe the tightening torque range.**
Tightening outside of the allowable torque range will likely damage the screw.
IP67 cannot be guaranteed if the screws are not tightened to the specified torque.
- When lifting a large size Manifold Solenoid Valve Unit, take care to avoid causing stress to the valve connection joint.**
The connection joint with the Unit may be damaged. Because the product may be heavy, carrying and installation should be performed by more than one operator to avoid strain or injury.
- When placing a manifold, mount it on a flat surface.**
Torsion in the whole manifold can lead to trouble such as air leakage or contact failure.

Wiring

Caution

- Provide the grounding to maintain the safety of the reduced wiring system and to improve the noise immunity.**
Provide a specific grounding as close to the Unit as possible to minimize the distance to grounding.
- Avoid repeatedly bending or stretching the cable and applying a heavy object or force to it.**
Wiring applying repeated bending and tensile stress to the cable can break the circuit.
- Avoid miswiring.**
If miswired, there is a danger of malfunction or damage to the reduced wiring system.

SV
SYJ
SZ
VF
VP4
VQ 1/2
VQ 4/5
VQC 1/2
VQC 4/5
VQZ
SQ
VFS
VFR
VQ7



VQC4000 Series

Specific Product Precautions 5

Be sure to read this before handling the products.

Refer to back page 50 for Safety Instructions and pages 3 to 9 for 3/4/5 Port Solenoid Valve Precautions.

EX600 Precautions

Wiring

Caution

- Do not wire while energizing the product.**
There is a danger of malfunction or damage to the reduced wiring system or input/output device.
- Avoid wiring the power line and high pressure line in parallel.**
Noise or surge produced by signal line resulting from the power line or high pressure line could cause a malfunction. Wiring of the reduced wiring system or input/output device and the power line or high pressure line should be separated from each other.
- Check for the wiring insulation.**
Defective insulation (contact with other circuits, improper insulation between terminals, etc.) may cause damage to the reduced wiring system or input/output device due to excessive voltage or current.
- When the reduced wiring system is installed in machinery/equipment, provide adequate protection against noise by using noise filters etc.**
Noise in signal lines may cause a malfunction.
- When connecting wires of input/output device or Handheld Terminal, prevent water, solvent or oil from entering inside from the connector section.**
Otherwise, this can cause damage, equipment failure or malfunction.
- Avoid wiring patterns in which excessive stress is applied to the connector.**
This may cause equipment failure or malfunction due to contact failure.

Operating Environment

Warning

- Do not use in an atmosphere containing an inflammable gas or explosive gas.**
Use in such an atmosphere is likely to cause a fire or explosion. This system is not explosion-proof.

Caution

- Select the proper type of enclosure according to the environment of operation.**
IP65/67 is achieved when the following conditions are met.
 - Provide appropriate wiring between Units using electrical wiring cables, communication connectors and cables with M12 connectors.
 - Suitable mounting of each Unit and manifold valve.
 - Be sure to mount a seal cap on any unused connectors.If using in an environment that is exposed to water splashes, please take measures such as using a cover.
When the enclosure is IP40, do not use in an operating environment or atmosphere where it may come in contact with corrosive gas, chemical agents, seawater, water, or water vapor. When connected to the EX600-D□□E or EX600-D□□F, manifold enclosure is IP40.
Also, the Handheld Terminal conforms to IP20, so prevent foreign matter from entering inside, and water, solvent or oil from coming in direct contact with it.

Operating Environment

Caution

- Provide adequate protection when operating in locations such as the following.**
Failure to do so may cause a malfunction or equipment failure. The effect of countermeasures should be checked in individual equipment and machine.
 - Where noise is generated by static electricity etc.
 - Where there is a strong electric field
 - Where there is a danger of exposure to radiation
 - When in close proximity to power supply lines
- Do not use in an environment where oil and chemicals are used.**
Operating in environments with coolants, cleaning solvents, various oils or chemicals may cause adverse effects (damage, malfunction) to the Unit even in a short period of time.
- Do not use in an environment where the product could be exposed to corrosive gas or liquid.**
This may damage the Unit and cause it to malfunction.
- Do not use in locations with sources of surge generation.**
Installation of the Unit in an area around the equipment (electromagnetic lifters, high frequency induction furnaces, welding machine, motors, etc.), which generates the large surge voltage could cause to deteriorate an internal circuitry element of the Unit or result in damage. Implement countermeasures against the surge from the generating source, and avoid touching the lines with each other.
- Use the product type that has an integrated surge absorption element when directly driving a load which generates surge voltage by relay, solenoid valves or lamp.**
When a surge generating load is directly driven, the Unit may be damaged.
- The product is CE marked, but not immune to lightning strikes. Take measures against lightning strikes in your system.**
- Keep dust, wire scraps and other foreign matter from entering inside the product.**
This may cause equipment failure or malfunction.
- Mount the Unit in such locations, where no vibration or shock is affected.**
This may cause equipment failure or malfunction.
- Do not use in places where there are cyclic temperature changes.**
In case that the cyclic temperature is beyond normal temperature changes, the internal Unit is likely to be adversely affected.
- Do not use in direct sunlight.**
This may cause equipment failure or malfunction.
- Observe the ambient temperature range.**
This may cause a malfunction.
- Do not use in places where there is radiated heat around it.**
Such places are likely to cause a malfunction.



VQC4000 Series Specific Product Precautions 6

Be sure to read this before handling the products.
Refer to back page 50 for Safety Instructions and pages 3 to 9 for 3/4/5 Port Solenoid Valve Precautions.

EX600 Precautions

Adjustment / Operation

⚠ Warning

1. Do not perform operation or setting with wet hands.
There is a risk of electrical shock.

<Handheld Terminal>

2. Do not apply pressure to the LCD.
There is a possibility of the crack of LCD and injuring.
3. The forced input/output function is used to change the signal status forcibly. When operating this function, be sure to check the safety of the surroundings and installation.
This may cause, injuries or equipment damage.
4. Incorrect setting of parameters can cause a malfunction. Be sure to check the settings before use.
This may cause injuries or equipment damage.

⚠ Caution

1. Use a watchmakers' screwdriver with thin blade for the setting of each switch of the SI Unit.
When setting the switch, do not touch other unrelated parts.
This may cause parts damage or malfunction due to a short circuit.
2. Provide adequate setting for the operating conditions.
Failure to do so could result in malfunction.
Refer to the Operation Manual for setting of the switches.
3. For details on programming and address setting, refer to the manual from the PLC manufacturer.
The content of programming related to protocol is designed by the manufacturer of the PLC used.

<Handheld Terminal>

4. Do not press the setting buttons with a sharp pointed object.
This may cause damage or equipment failure.
5. Do not apply excessive load and impact to the setting buttons.
This may cause damage, equipment failure or malfunction.

When the order does not include the SI Unit, a valve plate which connects the manifold and SI Unit, is not mounted. Use attached valve holding screws and mount the valve plate.
(Tightening torque: 0.6 to 0.7 N·m)

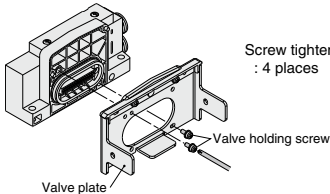

Maintenance

⚠ Warning

1. Do not disassemble, modify (including circuit board replacement) or repair this product.
Such actions are likely to cause injuries or equipment failure.
2. When an inspection is performed,
 - Turn off the power supply.
 - Stop the air supply, exhaust the residual pressure in piping and verify that the air is released before performing maintenance work.
Unexpected malfunction of system components and injury can result.

⚠ Caution

1. When handling and replacing Units:
 - Do not touch the sharp metal parts of the connector or plug.
 - Do not apply excessive force to the Unit when disassembling.
The connecting portions of the Unit are firmly joined with seals.
 - When joining Units, take care not to get fingers caught between Units.
Injury can result.
2. Perform periodic inspection.
Unexpected malfunction in the system composition devices is likely to occur due to malfunction of machinery or equipment.
3. After maintenance, make sure to perform an appropriate functionality inspection.
In cases of abnormality such as faulty operation, stop operation. Unexpected malfunction in the system composition devices is likely to occur.
4. Do not use benzine and thinner for cleaning Units.
Damage to the surface or erasure of the display can result. Wipe off any stains with a soft cloth.
If the stain is persistent, wipe off with a cloth soaked in a dilute solution of neutral detergent and wrung out tightly, and then finish with a dry cloth.

Other

⚠ Caution

1. Refer to the catalog of each series for Common Precautions and Specific Product Precautions on manifold solenoid valves.

■ Trademark

DeviceNet™ is a trademark of ODVA.
EtherNet/IP™ is a trademark of ODVA.
EtherCAT® is registered trademark and patented technology, licensed by Beckhoff Automation GmbH, Germany.

SV
SYJ
SZ
VF
VP4
VQ 1/2
VQ 4/5
VQC 1/2
VQC 4/5
VQZ
SQ
VFS
VFR
VQ7

Base Mounted

Plug-in: Single Unit

VQC5000 Series

Model

Series	Configuration	Model		Port size	Flow rate characteristics						Response time [ms]		Weight [kg]	
					1 → 4/2 (P → A/B)			4/2 → 5/3 (A/B → EA/EB)			Standard: 0.95 W	Low wattage type: 0.4 W		
					C [dm ³ /(s·bar)]	b	Cv	C [dm ³ /(s·bar)]	b	Cv				
VQC5000	2-position	Single	Metal seal	VQC5100	1/2	12	0.14	2.9	14	0.18	3.4	35	38	0.59
			Rubber seal	VQC5101		16	0.33	4.4	17	0.31	4.7	40	43	0.58
		Double	Metal seal	VQC5200		12	0.14	2.9	14	0.18	3.4	20	23	0.62
			Rubber seal	VQC5201		16	0.33	4.4	17	0.31	4.7	25	28	0.60
	3-position	Closed center	Metal seal	VQC5300		11	0.24	2.6	11	0.23	2.8	50	53	0.65
			Rubber seal	VQC5301		12	0.33	3.4	13	0.37	3.7	60	63	0.58
		Exhaust center	Metal seal	VQC5400		12	0.13	2.9	14	0.18	3.4	50	53	0.65
			Rubber seal	VQC5401		14	0.39	3.9	16	0.35	4.5	60	63	0.58
		Pressure center	Metal seal	VQC5500		12	0.23	2.9	13	0.24	3.3	50	53	0.65
			Rubber seal	VQC5501		13	0.32	3.4	14	0.40	3.9	60	63	0.58
		Double check	Metal seal	VQC5600		8.0	—	—	8.5	—	—	62	65	1.17
			Rubber seal	VQC5601		8.3	—	—	9.0	—	—	75	78	1.10

Note 1) Value for valve on sub-plate

Note 2) Cylinder port 1/2: Value for valve on sub-plate

Note 3) Based on JIS B 8419: 2010. (Supply pressure: 0.5 MPa [5.1 kgf/cm²], with indicator light and surge voltage

suppressor, clean air. This will change depending on pressure and air quality.) The value when ON for the double type.

Note 4) Table: Without sub-plate, With sub-plate: Add 0.65 kg.



Plug-in unit

Symbol

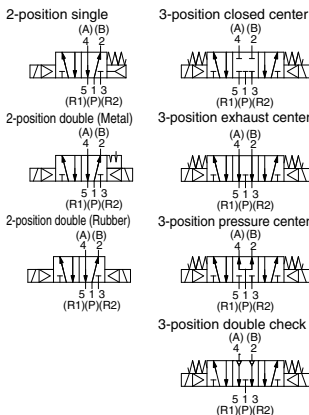

Standard Specifications

	Valve construction	Metal seal	Rubber seal	
	Fluid	Air/Inert gas		
Max. operating pressure	1.0 MPa			
Min. operating pressure	Single	0.10 MPa	0.20 MPa	
	Double	0.10 MPa	0.15 MPa	
	3-position	0.15 MPa	0.20 MPa	
Ambient and fluid temperature	-5 to 50°C (Note 1)			
Lubrication	Not required			
Manual override	Push type/Locking type (Tool required) Option/Locking type (Manual)			
Impact/Vibration resistance	150/30 m/s ² (Note 2)			
Enclosure	Dust-tight (IP67 compatible) (Note 3)			
Electrical specifications	Coil rated voltage	12, 24 VDC		
	Allowable voltage fluctuation	±10% of rated voltage		
	Coil insulation type	Class B or equivalent		
	Power consumption [W]	24 VDC	0.95, 0.4	
		12 VDC	0.95, 0.4	

Note 1) Use dry air to prevent condensation when operating at low temperatures.

Note 2) Impact resistance: No malfunction occurred when it is tested with a drop tester in the axial direction and at the right angles to the main valve and armature in both energized and de-energized states every once for each condition. (Values at the initial period)

Vibration resistance: No malfunction occurred in a one-sweep test between 45 and 2000 Hz. Test was performed at both energized and de-energized states in the axial direction and at the right angles to the main valve and armature. (Values at the initial period)

Note 3) Only applicable to S, T, L and M kits



How to Order Valves

Plug-in

VQC5 1 0 0 - 5 1 -

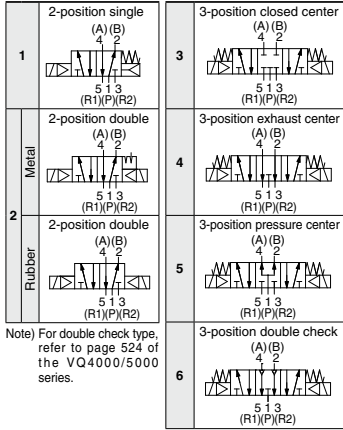

Thread type

Nil	Rc
N	NPT
T	NPTF
F	G

Port size

Nil	Without sub-plate (For manifold)
04	1/2

Porting specifications

Nil	Side ported
B	Bottom ported

Manual override

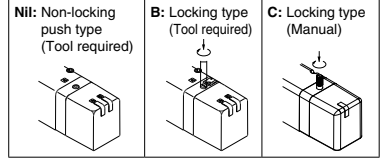

Body

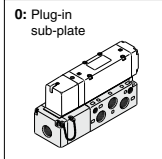

Seal

0	Metal seal
1	Rubber seal

Function

Nil (Note 1)	Standard (0.95 W)
Y	Low wattage type (0.4 W)
R (Note 2)	External pilot

Note 1) When the power is energized continuously, refer to "Specific Product Precautions 1" on page 680.
 Note 2) For details about external pilot type, refer to page 527 of the VQ4000/5000 series. In addition, external pilot type cannot be combined with a double check spacer.
 Note 3) When multiple symbols are specified, indicate them alphabetically.

Light/Surge voltage suppressor

Nil	Yes
E	Without light, with surge voltage suppressor

Coil voltage

5	24 VDC
6	12 VDC

- SV
- SYJ
- SZ
- VF
- VP4
- VQ 1/2
- VQ 4/5
- VQC 1/2
- VQC 4/5**
- VQZ
- SQ
- VFS
- VFR
- VQ7



How to Order Sub-plates

VQ5000 - PW - 04 -

Porting specifications

Nil	Side ported
B	Bottom ported

CE-compliant

Nil	-
Q	CE-compliant

Port size

04	1/2
----	-----

Thread type

Nil	Rc
N	NPT
T	NPTF
F	G

Note) For bottom ported, port size is 1/2 only.

Replacement of pilot valve assembly (Voltage)
 · Refer to page 678 for pilot valve assembly part numbers.
 · Refer to page 681 for replacement method.

VQC5000 Series

Plug-in Type

Conduit terminal

2-position single: VQC510⁰

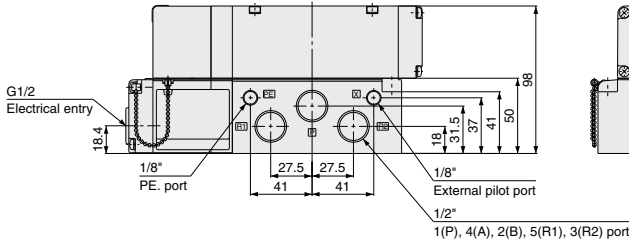
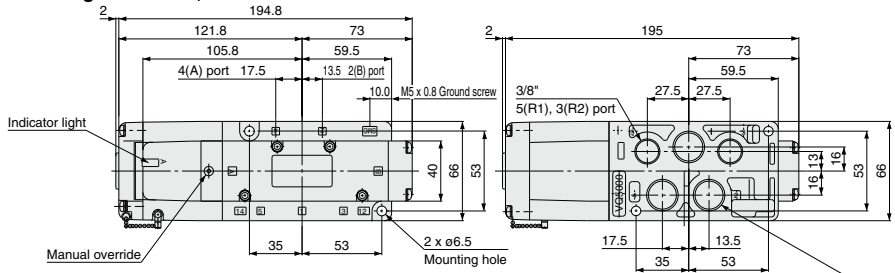

2-position double: VQC520⁰

3-position closed center: VQC530⁰

3-position exhaust center: VQC540⁰

3-position pressure center: VQC550⁰

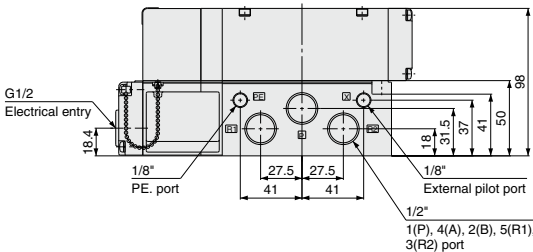
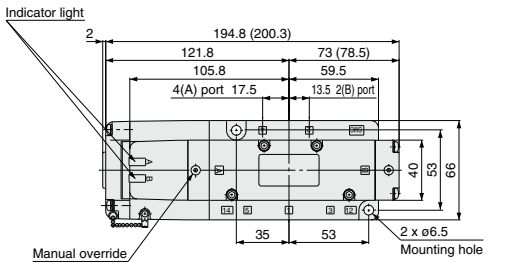

Numbers inside () are for metal seal 3-position type.

3-position double check: VQC560⁰

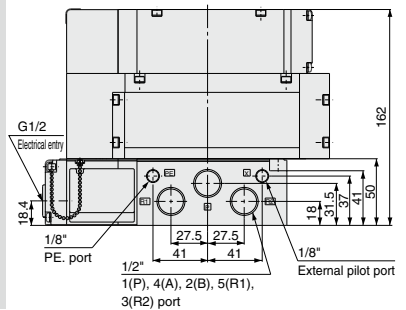
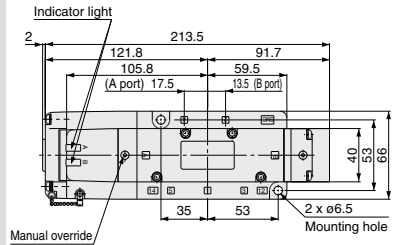

SV
SYJ
SZ
VF
VP4
VQ 1/2
VQ 4/5
VQC 1/2
VQC 4/5
VQZ
SQ
VFS
VFR
VQ7

Base Mounted

Plug-in Unit

VQC5000 Series

How to Order Manifold

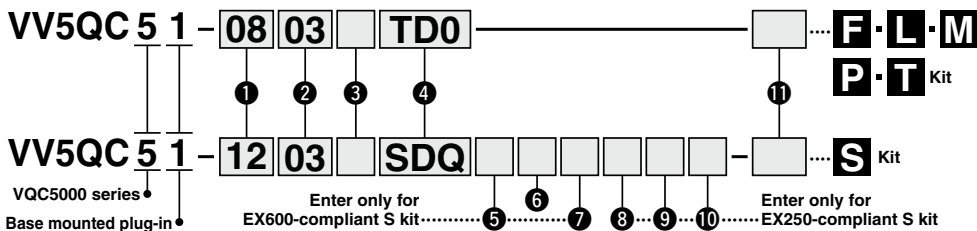

1 Valve stations

01	1 station
⋮	⋮

The maximum number of stations differs depending on the electrical entry. (Refer to 10.)
Note) In the case of compatibility with the S kit/As-Interface, the maximum number of solenoids is as shown below, so please be careful of the number of stations.
8 in/8 out: Maximum 8 solenoids
4 in/4 out: Maximum 4 solenoids

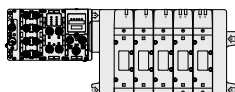

 Stations 1 ---- 2 ---- 3 ---- 4 ---- 5 ---- 6 

* Stations are counted from station 1 on the D-side.

2 Cylinder port size

03	3/8
04	1/2
B	Bottom ported 1/2
CM	Mixed

3 Thread type

Nil	Rc
F	G
N	NPT
T	NPTF

5 End plate type

(Enter only for EX600-compliant S kit.)

Nil	Without end plate
2	M12 power supply connector, B-coded
3	7/8 inch power supply connector
4	M12 power supply connector IN/OUT, A-coded, Pin arrangement 1
5	M12 power supply connector IN/OUT, A-coded, Pin arrangement 2

Note) Without SI Unit, the symbol is nil.
* The pin layout for "4" and "5" pin connector is different.

6 SI Unit output polarity

SI Unit output polarity	EX250 integrated-type (for I/O) serial transmission system				
	DeviceNet™	PROFIBUS DP	AS-Interface	CANopen	EtherNet/IP™
Nil + COM	—	—	—	—	—
N - COM	○	○	○	○	○

SI Unit output polarity	EX260 integrated-type (for output) serial transmission system							
	DeviceNet™	PROFIBUS DP	CC-Link	EtherCAT	PROFINET	EtherNet/IP™	EtherPowerLink™	IO-Link
Nil + COM	○	○	○	○	○	○	○	—
N - COM	○	○	○	○	○	○	○	○

SI Unit output polarity	EX500 Gateway Decentralized System 2 (128 points)		EX500 Gateway Decentralized System (64 points)		
	EtherNet/IP™	PROFINET	DeviceNet™	PROFIBUS DP	EtherNet/IP™
Nil + COM	—	—	○	○	○
N - COM	○	○	○	○	○

SI Unit output polarity	EX600 integrated-type (for I/O) serial transmission system (Fieldbus system)								
	DeviceNet™	PROFIBUS DP	CC-Link	EtherNet/IP™	EtherCAT	PROFINET	EtherNet/IP™ compatible wireless base	PROFINET compatible wireless base	Wireless remote
Nil + COM	○	○	○	○	○	○	○	○	○
N - COM	○	○	○	○	○	○	○	○	○

* Leave the box blank for without SI Unit (SD0□, SD6□).

7 I/O Unit stations

(Enter only for EX600-compliant S kit.)

Nil	None
1	1 station
⋮	⋮
9	9 stations

Note 1) Without SI Unit, the symbol is nil.
Note 2) SI Unit is not included in I/O Unit stations.
Note 3) When I/O Unit is selected, it is shipped separately, and assembled by customer. Refer to the attached operation manual for mounting method.
Note 4) Refer to page 646 for details about the enclosure.

8 Number of input blocks

(Enter only for S kit compliant with EX250.)

Nil	Without SI Unit (SD0)
0	Without input block
1	With 1 input block
⋮	⋮
4	With 4 input blocks
⋮	⋮
8	With 8 input blocks

9 Input block type

(Enter only for S kit compliant with EX250.)

Nil	Without input block
1	M12, 2 inputs
2	M12, 4 inputs
3	M8, 4 inputs

10 Input block COM

(Enter only for S kit compliant with EX250.)

Nil	PNP sensor input or without input block
N	NPN sensor input

11 Option

Nil	None
K	Special wiring specifications (except for double wiring)
N	With name plate (available for T kit only)

Refer to Best Pneumatics No. 1-1 and the Operation Manual for the details of EX600 Integrated-type (For I/O) Serial Transmission System. Please download the Operation Manual via our website, <http://www.smcworld.com>

4 Kit type/Electrical entry/Cable length

*The number in parentheses indicates the maximum number of stations and the maximum number of solenoids that can be used in the case of mixed single and double wiring. The total number of solenoids determines the maximum number of stations. When ordering mixed wiring, please add the option symbol "K".

S Kit (Serial transmission kit (Fieldbus system) : EX600 integrated-type (for I/O))

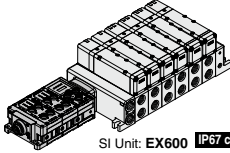

SI Unit: EX600 IP67 compliant

SD60	Serial kit without SI Unit	1 to 12 stations (24 points)
SD6Q	DeviceNet™	
SD6N	PROFIBUS DP	
SD6V	CC-Link	
SD6F	PROFINET	
SD6ZE	EtherNet/IP™ (1 port)	
SD6EA	EtherNet/IP™ (2 port)	
SD6D	EtherCAT	
SD6WE	EtherNet/IP™ compatible wireless base ^{Note 5)}	
SD6WF	PROFINET compatible wireless base ^{Note 5)}	
SD6WS	Wireless remote ^{Note 5)}	

S Kit (Serial transmission kit: EX500 gateway-type)

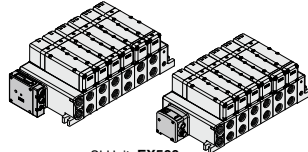

SI Unit: EX500

Note) A separate Gateway Unit and communication cable are required. IP67 compliant

SD0	Serial kit without SI Unit	—	1 to 12 stations
SDA3	EX500 Gateway Decentralized System 2 (128 points) EtherNet/IP™, PROFINET	32 outputs ^{Note 1)}	1 to 12 stations
SDA2	EX500 Gateway Decentralized System (64 points) DeviceNet™, PROFIBUS DP, EtherNet/IP™	16 outputs	1 to 8 stations (12 stations, 16 points)

S Kit (Serial transmission kit: EX260 integrated-type (for output))

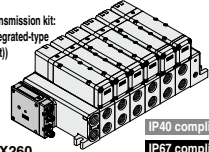

SI Unit: EX260

IP67 compliant

Symbol	Protocol	Number of outputs	Communication connector	Stations
Serial kit without SI Unit				
SD0				1 to 12 stations
SQA	DeviceNet™	32	M12	1 to 12 stations
SQB		16		1 to 8 stations (12 stations, 16 points)
SNA		32	M12	1 to 12 stations
SNC	PROFIBUS DP	16		1 to 8 stations (12 stations, 16 points)
SNB		32	D-sub ^{Note 3)}	1 to 12 stations
SND		16		1 to 8 stations (12 stations, 16 points)
SVA	CC-Link	32	M12	1 to 12 stations
SVB		16		1 to 8 stations (12 stations, 16 points)
SDA	EtherCAT	32	M12	1 to 12 stations
SDB		16		1 to 8 stations (12 stations, 16 points)
SFA	PROFINET	32	M12	1 to 12 stations
SFB		16		1 to 8 stations (12 stations, 16 points)
SEA	EtherNet/IP™	32	M12	1 to 12 stations
SEB		16		1 to 8 stations (12 stations, 16 points)
SGA	Ethernet	32	M12	1 to 12 stations
SEB	POWERLINK	16		1 to 8 stations (12 stations, 16 points)
SKA	IO-Link	32	M12	1 to 12 stations

S Kit (Serial transmission kit: EX250 integrated-type (for I/O))

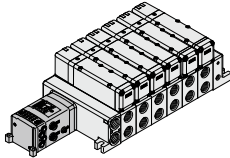

SI Unit: EX250

IP67 compliant

SD0	Serial kit without SI Unit	1 to 12 stations
SDQ	DeviceNet™	
SDN	PROFIBUS DP	
SDTA	AS-Interface, 8 in/out, 31 slave modes, 2 power supply systems	
SDTB	AS-Interface, 4 in/out, 31 slave modes, 2 power supply systems	
SDTC ^{Note 2)}	AS-Interface, 8 in/out, 31 slave modes, 1 power supply system	
SDTD ^{Note 2)}	AS-Interface, 4 in/out, 31 slave modes, 1 power supply system	
SDY	CANopen	
SDZEN	EtherNet/IP™	

S Kit (Serial transmission kit: EX126 integrated-type (for output))

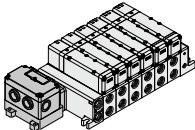

SI Unit: EX126

IP67 compliant

SDVB	Serial kit for CC-Link	1 to 8 stations (12 stations, 16 points)
------	------------------------	------------------------------------------

P Kit (Flat ribbon cable kit)

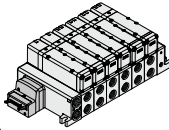

IP40 compliant

Note) For a 20P flat ribbon cable, the cable assembly must be ordered separately.

PD0	Flat ribbon cable kit (26P) without cable	1 to 12 stations
PD1	Flat ribbon cable kit (26P) with 1.5 m cable	
PD2	Flat ribbon cable kit (26P) with 3.0 m cable	
PD3	Flat ribbon cable kit (26P) with 5.0 m cable	
PDC	Flat ribbon cable kit (20P) without cable ^{Note)}	

F Kit (D-sub connector kit)

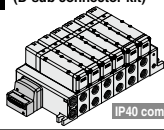

IP40 compliant

FD0	D-sub connector kit (25P) without cable	1 to 12 stations
FD1	D-sub connector kit (25P) with 1.5 m cable	
FD2	D-sub connector kit (25P) with 3.0 m cable	
FD3	D-sub connector kit (25P) with 5.0 m cable	

M Kit (Circular connector kit)

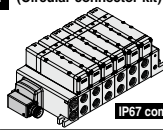

IP67 compliant

MD0	Circular connector kit (26P) without cable	1 to 12 stations
MD1	Circular connector kit (26P) with 1.5 m cable	
MD2	Circular connector kit (26P) with 3.0 m cable	
MD3	Circular connector kit (26P) with 5.0 m cable	

T Kit (Terminal block box kit)

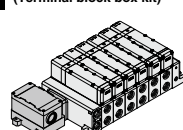

IP67 compliant

TD0	Terminal block box kit	1 to 10 stations (12 stations, 20 points)
-----	------------------------	-------------------------------------------

L Kit (Lead wire kit)



IP67 compliant

LD0	Lead wire kit, 0.6 m lead wire	1 to 12 stations
LD1	Lead wire kit, 1.5 m lead wire	
LD2	Lead wire kit, 3.0 m lead wire	

*The maximum number of stations and the maximum number of solenoids indicated in parentheses are applied to special wiring specifications only (Option "K").

Note 1) When using the SI Unit with 32 outputs, use the GW Unit compatible with the EX500 Gateway Decentralized System 2 (128 points).

Note 2) When selecting SI Units with SDTC or SDTD specifications, there are limits to the supply current from the SI Unit to the input block or valve. For details, refer to page 805 in Best Pneumatics No. 1-1.

Note 3) When selecting D-sub 5 kit specifications only, IP40 is compatible. (All other SI Units are IP67 compliant.)

Note 4) For the SI Unit part no., refer to page 655.

Note 5) The wireless system is suitable for use only in a country where it is in accordance with the Radio Act and regulations of that country.

SV
SYJ
SZ
VF
VP4
VQ 1/2
VQ 4/5
VQC 1/2
VQC 4/5
VQZ
SQ
VFS
VFR
VQ7

VQC5000 Series

How to Order Valves

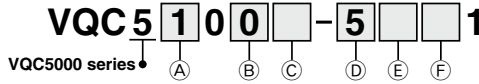

A) Type of actuation

1	2-position single (A) (B) (R1) (P) (R2)	3-position exhaust center (A) (B) (R1) (P) (R2)
2	2-position double (Metal) (A) (B) (R1) (P) (R2)	3-position pressure center (A) (B) (R1) (P) (R2)
	2-position double (Rubber) (A) (B) (R1) (P) (R2)	3-position double check (A) (B) (R1) (P) (R2)
3	3-position closed center (A) (B) (R1) (P) (R2)	

B) Seal type

0	Metal seal
1	Rubber seal

C) Function

Nil <small>(Note 1)</small>	Standard (0.95 W)
Y	Low wattage type (0.4 W)
R <small>(Note 2)</small>	External pilot

Note 1) When the power is energized continuously, refer to "Specific Product Precautions 1" on page 680.

Note 2) For details about external pilot type, refer to page 527 of the VQ4000/5000 series.

* When multiple symbols are specified, indicate them alphabetically.

D) Coil voltage

5	24 VDC <small>(Note)</small>
6	12 VDC

Note) S kit is only available for 24 VDC.

E) Light/Surge voltage suppressor

Nil	Yes
E	Without light, with surge voltage suppressor

F) Manual override

Nil	Non-locking push type (Tool required)
B	Push-turn locking type (Tool required)
C	Turn locking type (Manual)

How to Order Manifold Assembly

Example (VV5QC51-□SD6□)

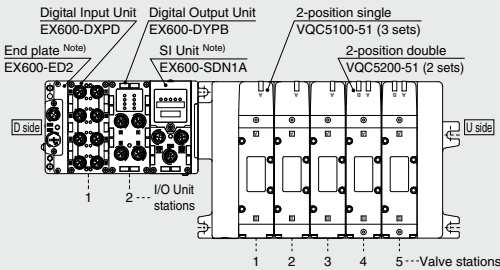

VV5QC51-0503SD6Q2N2--1 set (S kit 5-station manifold base part number)

=VQC5100-51.....3 sets (2-position single part number)

=VQC5200-51.....2 sets (2-position double part number)

=EX600-DXPD.....1 set I/O Unit part number (Station 1)

=EX600-DYPB.....1 set I/O Unit part number (Station 2)

* The asterisk denotes the symbol for assembly.
* Prefix it to the part numbers of the valve etc.

· The valve arrangement is numbered as the 1st station from the D side.
· Under the manifold part number, state the valves to be mounted, then the I/O Units in order from the 1st station as shown in the figure above. If the arrangement becomes complicated, specify on a manifold specification sheet.

Note) Do not enter the SI Unit part number and the end plate part number together.

Manifold Specifications

Series	Base model	Connection type	Piping specifications		Note 2) Applicable stations	Applicable solenoid valve	5-station weight [g]	
			Port direction	Port size <small>(Note 1)</small>				
				1, 3 (P, R)				2, 4 (A, B)
VQC5000	VV5QC51-□□□	<ul style="list-style-type: none"> ■ F kit: D-sub connector ■ P kit: Flat ribbon cable ■ T kit: Terminal block box ■ S kit: Serial transmission ■ L kit: Lead wire ■ M kit: Circular connector 	Side	D side	3/8, 1/2	(F, L, M, P kit (1 to 12 stations) T kit (1 to 10 stations) S kit (1 to 12 stations: EX260, EX260) (1 to 12 stations: EX500, EX600)	VQC5□00-51 VQC5□01-51	4330 · S kit (Without Unit) · Not including valve weight.
			Bottom	U side	1/2			

Note 1) One-touch fittings in inch sizes are also available.

Note 2) As an optional specification, the maximum number of stations can be increased by special wiring specifications.

SI Unit Part Number Table

EX600

Symbol	Applicable protocol	SI Unit part no.		Page
		Negative common (PNP)	Positive common (NPN)	
SD6Q	DeviceNet™	EX600-SDN1A	EX600-SDN2A	638
SD6N	PROFIBUS DP	EX600-SPR1A	EX600-SPR2A	
SD6V	CC-Link	EX600-SMJ1	EX600-SMJ2	
SD6F	PROFINET	EX600-SPN1	EX600-SPN2	
SD6ZE	EtherNet/IP™ (1 port)	EX600-SEN1	EX600-SEN2	
SD6EA	EtherNet/IP™ (2 port)	EX600-SEN3	EX600-SEN4	
SD6D	EtherCAT	EX600-SEC1	EX600-SEC2	
SD6WE	EtherNet/IP™ compatible wireless base (NPN)	EX600-WEN1	EX600-WEN2	
SD6WF	PROFINET compatible wireless base (NPN)	EX600-WPN1	EX600-WPN2	
SD6WS	Wireless remote (NPN)	EX600-WSV1	EX600-WSV2	

Note) The wireless system is suitable for use only in a country where it is in accordance with the Radio Act and regulations of that country.

EX260

Symbol	Applicable protocol	Number of outputs	SI Unit part no.		Communication connector	Page
			Negative common (PNP)	Positive common (NPN)		
SQA	DeviceNet™	32	EX260-SDN1	EX260-SDN2	M12	638
SQB		16	EX260-SDN3	EX260-SDN4		
SNA	PROFIBUS DP	32	EX260-SPR1	EX260-SPR2	D-sub	
SNB		16	EX260-SPR3	EX260-SPR4		
SNC	CC-Link	32	EX260-SPR5	EX260-SPR6	M12	
SND		16	EX260-SPR7	EX260-SPR8		
SVA	EtherCAT	32	EX260-SMJ1	EX260-SMJ2	M12	
SVB		16	EX260-SMJ3	EX260-SMJ4		
SDA	PROFINET	32	EX260-SEC1	EX260-SEC2	M12	
SDB		16	EX260-SEC3	EX260-SEC4		
SFA	EtherNet/IP™	32	EX260-SPN1	EX260-SPN2	M12	
SFB		16	EX260-SPN3	EX260-SPN4		
SEA	EtherNet/IP™	32	EX260-SEN1	EX260-SEN2	M12	
SEB		16	EX260-SEN3	EX260-SEN4		
SGA	POWERLINK	32	EX260-SPL1	—	M12	
SGB		16	EX260-SPL3	—		
SKA	IO-Link	32	EX260-SIL1	—	M12	

EX126

Symbol	Applicable protocol	SI Unit part no.	Page
SDVB	CC-Link, Positive common (NPN)	EX126D-SMJ1	639

EX500 Gateway Decentralized System 2 (128 points)

Symbol	Applicable protocol	SI Unit part no.		Page
		Negative common (PNP)		
SDA3	EtherNet/IP™ PROFINET	EX500-S103		638

EX500 Gateway Decentralized System (64 points)

Symbol	Applicable protocol	SI Unit part no.		Page
		Positive common (NPN)	Negative common (PNP)	
SDA2	DeviceNet™ PROFIBUS DP EtherNet/IP™	EX500-Q001	EX500-Q101	638

EX250

Symbol	Applicable protocol	SI Unit part no.	Page
SDQ	DeviceNet™, Negative common (PNP)	EX250-SDN1	639
SDN	PROFIBUS DP, Negative common (PNP)	EX250-SPR1	
SDTA	AS-Interface, Negative common (PNP), (8 in/8 out, 31 slave modes, 2 power supply systems)	EX250-SAS3	
SDTB	AS-Interface, Negative common (PNP), (4 in/4 out, 31 slave modes, 2 power supply systems)	EX250-SAS5	
SDTC	AS-Interface, Negative common (PNP), (8 in/8 out, 31 slave modes, 1 power supply system)	EX250-SAS7	
SDTD	AS-Interface, Negative common (PNP), (4 in/4 out, 31 slave modes, 1 power supply system)	EX250-SAS9	
SDY	CANopen, Negative common (PNP)	EX250-SCA1A	
SDZEN	EtherNet/IP™, Negative common (PNP)	EX250-SEN1	

For details about the EX series (Serial Transmission System), refer to Best Pneumatics No. 1-1 and the Operation Manual. Please download the Operation Manual via SMC website, <http://www.smcworld.com>

Manifold Options

For details about options, refer to page 522 or later of the VQ5000 series.

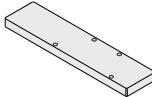
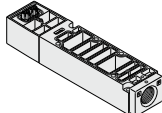
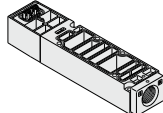
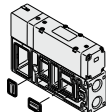
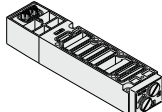
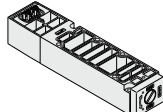
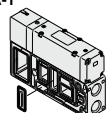
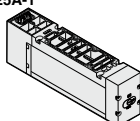
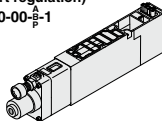
<p>Blanking plate assembly VVQ5000-10A-1</p> 	<p>Individual SUP spacer VVQ5000-P-1-⁰³/₀₄</p> 	<p>Individual EXH spacer VVQ5000-R-1-⁰³/₀₄</p> 
<p>EXH block plate VVQ5000-16A-2 (1 pc./set) (Order q'ty: 2 pcs.)</p> 	<p>Restrictor spacer VVQ5000-20A-1</p> 	<p>SUP stop valve spacer VVQ5000-37A-1</p> 
<p>SUP block plate VVQ5000-16A-1</p> 	<p>Double check spacer with residual pressure exhaust VVQ5000-25A-1</p> 	<p>Interface regulator (P, A, B port regulation) ARBQ5000-00-⁰³/_{B-1}</p> 

For replacement parts, refer to page 678

VQC5000 Series

S VQC5000

Kit (Serial transmission kit): For EX600 Integrated-type (I/O) Serial Transmission System **IP67 compliant**

VV5QC51

S kit (Serial transmission kit: EX600)

Power supply with M12 connector

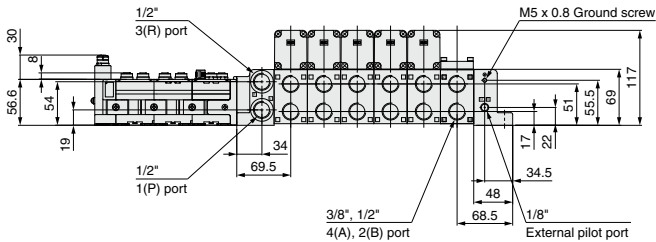
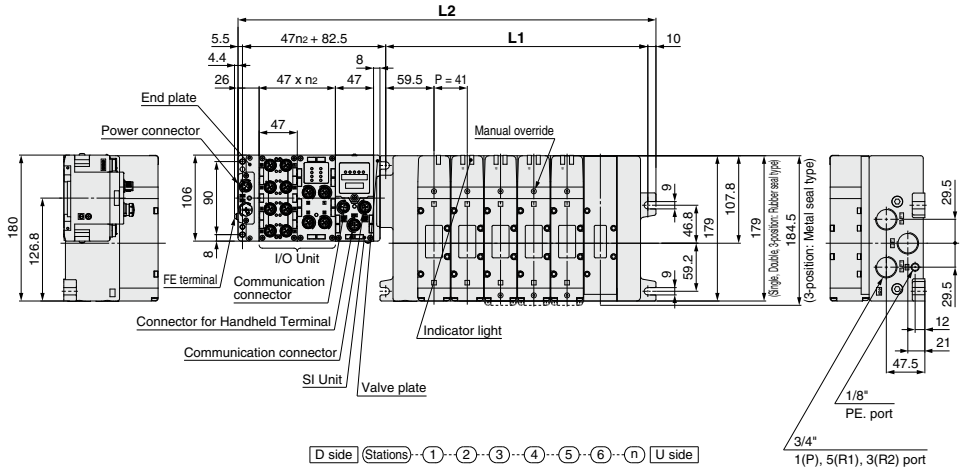

Bottom ported

<-P/R port side>

<-Bottom side>

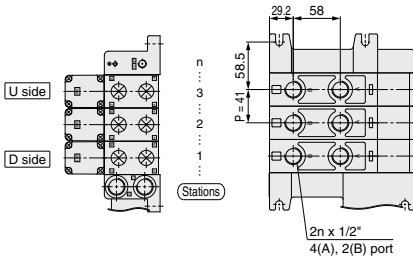

* Other dimensions are the same as the side ported type.

Dimensions

Formula: L1 = 41n + 77, L2 = 41n + 175 + L2 is the dimension without I/O Unit. Add 47 mm for each additional I/O Units. * "n" is number of I/O Units. n: Stations (Maximum 12 stations)

L \ n	1	2	3	4	5	6	7	8	9	10	11	12
L1	118	159	200	241	282	323	364	405	446	487	528	569
L2	216	257	298	339	380	421	462	503	544	585	626	667



VQC5000

Kit (Serial transmission kit): For EX600 Integrated-type (I/O) Serial Transmission System IP67 compliant

VV5QC51

S kit (Serial transmission kit: EX600)

Power supply with 7/8 inch connector

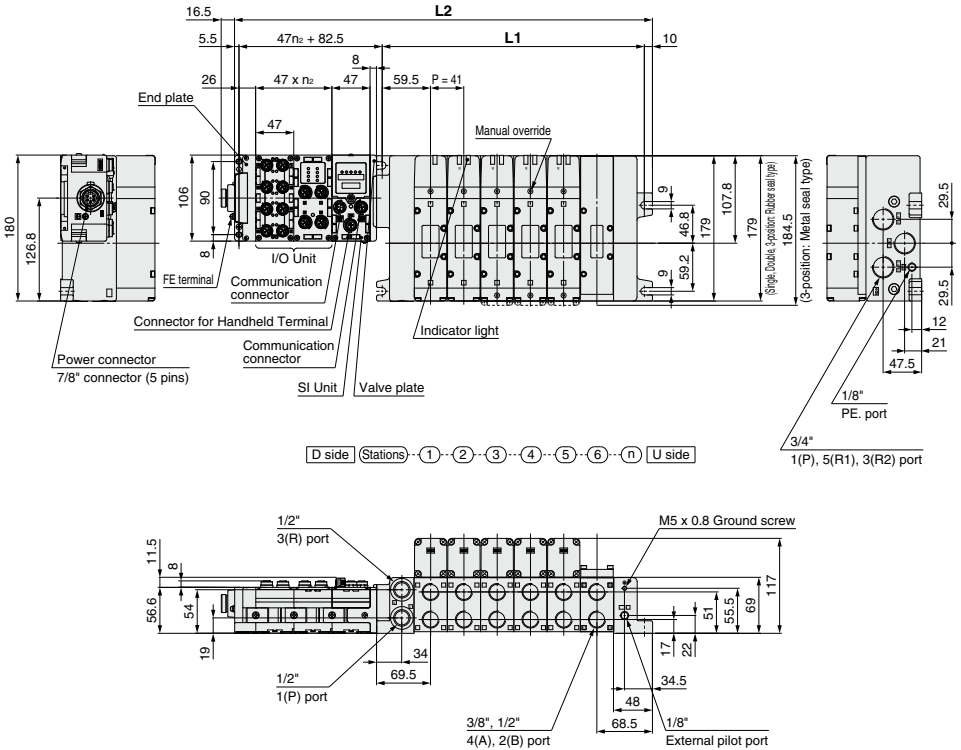

SV
SYJ
SZ
VF
VP4
VQ 1/2
VQ 4/5
VQC 1/2
VQC 4/5
VQZ
SQ
VFS
VFR
VQ7

Note) The dimensions of the bottom ported type are common to all S kits.

Dimensions Formula: L1 = 41n + 77, L2 = 41n + 175 + L2 is the dimension without I/O Unit. Add 47 mm for each additional I/O Units. "n" is number of I/O Units. n: Stations (Maximum 12 stations)

L	n	1	2	3	4	5	6	7	8	9	10	11	12
L1		118	159	200	241	282	323	364	405	446	487	528	569
L2		216	257	298	339	380	421	462	503	544	585	626	667

VQC5000 Series

S VQC5000

Kit (Serial transmission kit): For EX500 Gateway Decentralized System 2 (128 points) **IP67 compliant**

VV5QC51

S kit (Serial transmission kit: EX500)

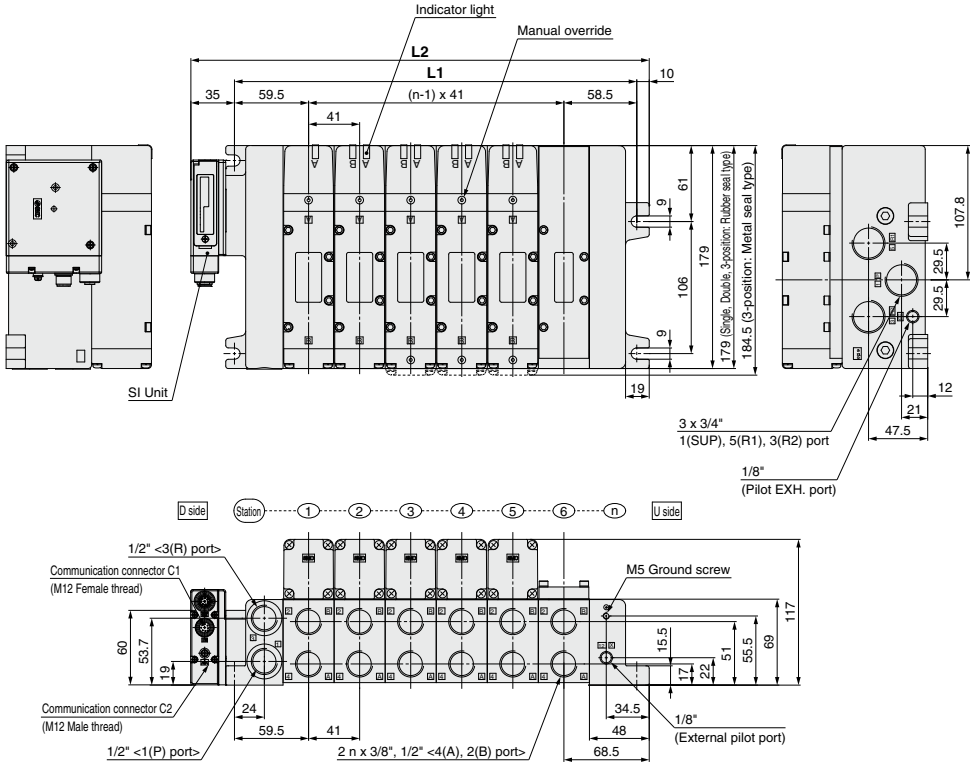

Note) The dimensions of the bottom ported type are common to all S kits.

Formula: $L1 = 41n + 77$, $L2 = 41n + 122$ n: Stations (Maximum 12 stations)

L \ n	1	2	3	4	5	6	7	8	9	10	11	12
L1	118	159	200	241	282	323	364	405	446	487	528	569
L2	163	204	245	286	327	368	409	450	491	532	573	614



VQC5000

Kit (Serial transmission kit): For EX500 Gateway Decentralized System (64 points) IP67 compliant

VV5QC51

S kit (Serial transmission kit: EX500)

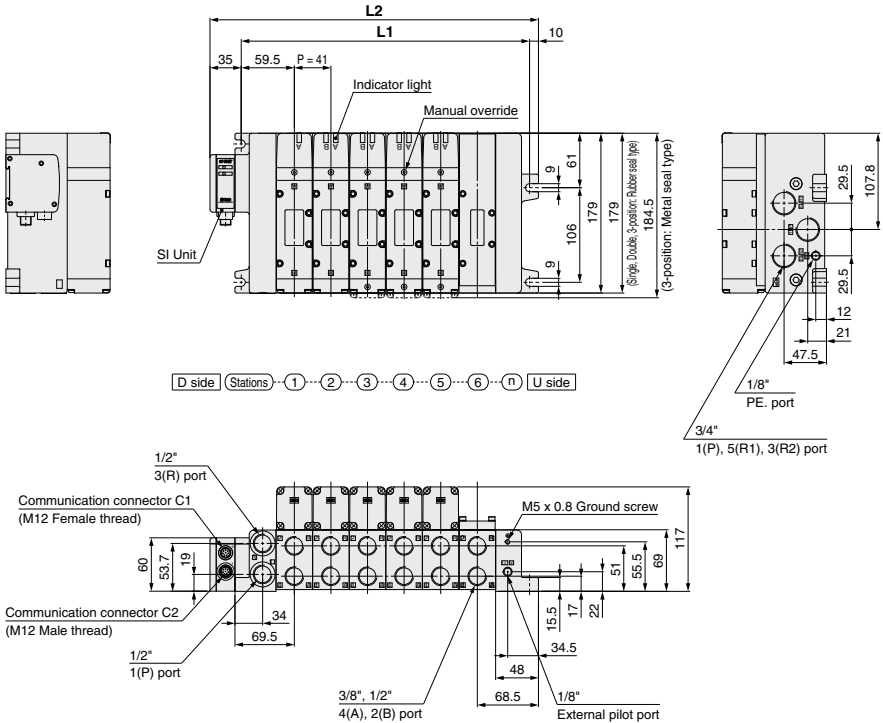

Note) The dimensions of the bottom ported type are common to all S kits.

Dimensions

Formula: L1 = 41n + 77, L2 = 41n + 122 n: Stations (Maximum 12 stations)

L \ n	1	2	3	4	5	6	7	8	9	10	11	12
L1	118	159	200	241	282	323	364	405	446	487	528	569
L2	163	204	245	286	327	368	409	450	491	532	573	614

- SV
- SYJ
- SZ
- VF
- VP4
- VQ 1/2
- VQ 4/5
- VQC 1/2
- VQC 4/5**
- VQZ
- SQ
- VFS
- VFR
- VQ7

VQC5000 Series

S VQC5000

Kit (Serial transmission kit): For EX260 Integrated-type (Output) Serial Transmission System

IP40 compliant

IP67 compliant

VV5QC51

S kit (Serial transmission kit: EX260)

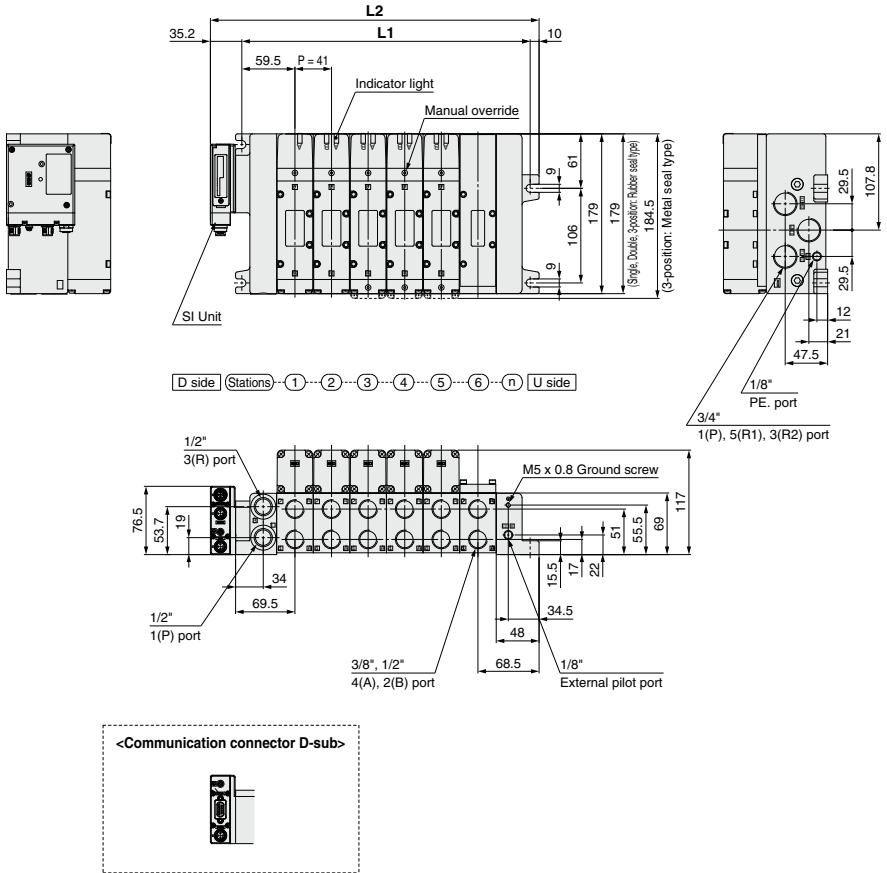

Note) The dimensions of the bottom ported type are common to all S kits.

Dimensions

Formula: $L1 = 41n + 77$, $L2 = 41n + 122.2$ n: Stations (Maximum 12 stations)

L	n	1	2	3	4	5	6	7	8	9	10	11	12
L1		118	159	200	241	282	323	364	405	446	487	528	569
L2		163.2	204.2	245.2	286.2	327.2	368.2	409.2	450.2	491.2	532.2	573.2	614.2



VQC5000

Kit (Serial transmission kit): For EX250 Integrated-type (I/O) Serial Transmission System IP67 compliant

VV5QC51

S kit (Serial transmission kit: EX250)

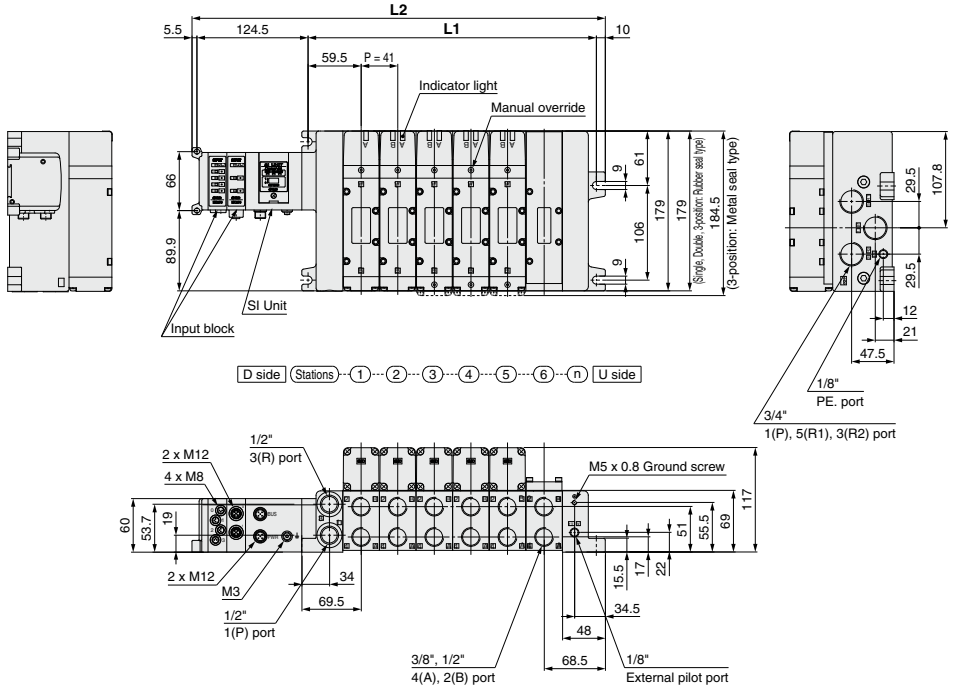

SV
SYJ
SZ
VF
VP4
VQ 1/2
VQ 4/5
VQC 1/2
VQC 4/5
VQZ
SQ
VFS
VFR
VQ7

Note) The dimensions of the bottom ported type are common to all S kits.

Dimensions Formula: L1 = 41n + 77, L2 = 41n + 196 (For one input block. Add 21 mm for each additional input block.) n: Stations (Maximum 12 stations)

L	n	1	2	3	4	5	6	7	8	9	10	11	12
L1		118	159	200	241	282	323	364	405	446	487	528	569
L2		237	278	319	360	401	442	483	524	565	606	647	688

VQC5000 Series

S VQC5000 Kit (Serial transmission kit): For EX126 Integrated-type (Output) Serial Transmission System **IP67 compliant**

VV5QC51
S kit (Serial transmission kit: EX126)

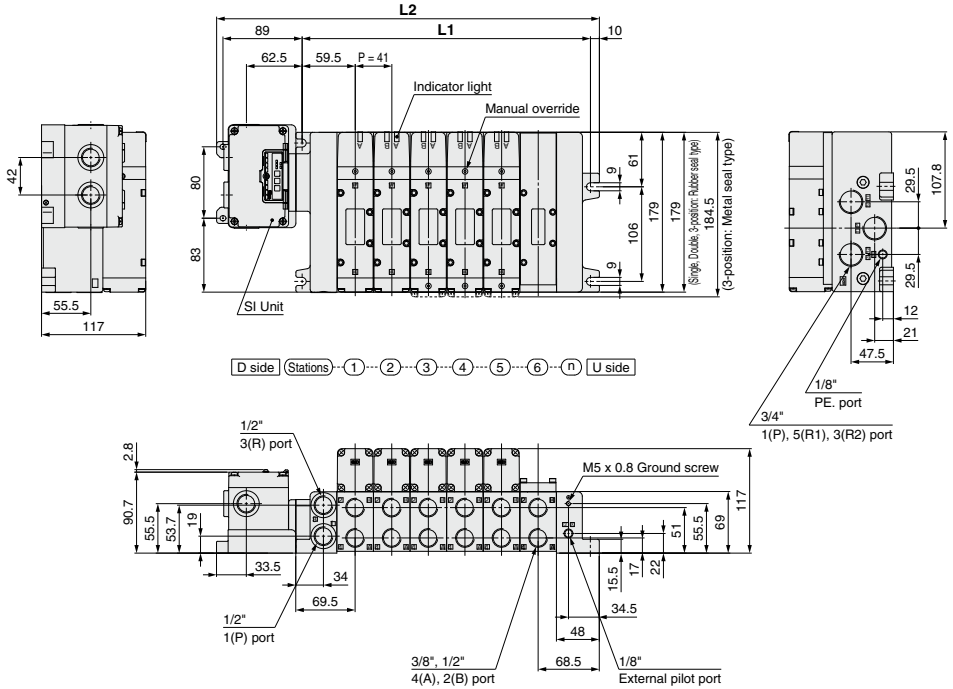

Note) The dimensions of the bottom ported type are common to all S kits.

Dimensions

Formula: $L_1 = 41n + 77$, $L_2 = 41n + 182.8$ n: Stations (Maximum 12 stations)

n	1	2	3	4	5	6	7	8	9	10	11	12
L1	118	159	200	241	282	323	364	405	446	487	528	569
L2	223.8	264.8	305.8	346.8	387.8	428.8	469.8	510.8	551.8	592.8	633.8	674.8

SV
SYJ
SZ
VF
VP4
VQ 1/2
VQ 4/5
VQC 1/2
VQC 4/5
VQZ
SQ
VFS
VFR
VQ7

VQC5000 Series

F VQC5000 Kit (D-sub connector kit) IP40 compliant

- Using our D-sub connector for electrical connections greatly reduces labor, while it also minimizes wiring and saves space.
- We use a D-sub connector (25P) that conforms to MIL standards and is therefore widely compatible with many standard commercial models.
- Top or side entry for the connector can be changed freely, allowing for changes even after mounting, to meet any changing needs for space.

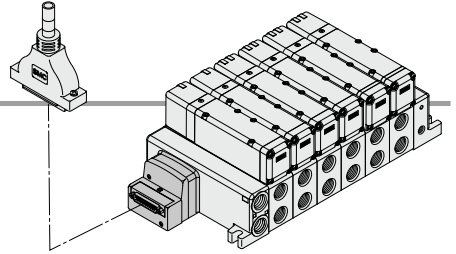

Electrical Wiring Specifications

D-sub connector

As the standard electrical wiring specification used is for 12 stations or less, double wiring (connected to SOL. A and SOL. B) is used for the internal wiring of each station regardless of valve and option types. Mixed single and double wiring are available as options. Refer to special wiring specifications (options) below.

Lead wire colors for D-sub connector assemblies (AXT100-DS25-015, 030, 050)

Standard wiring	Terminal no.	Lead wire color	Dot marking
Station 1 { SOL.A } 1	1	Black	None
Station 1 { SOL.B } 2	2	Yellow	Black
Station 2 { SOL.A } 14	14	Brown	None
Station 2 { SOL.B } 15	15	Pink	Black
Station 3 { SOL.A } 3	3	Red	None
Station 3 { SOL.B } 16	16	Blue	White
Station 4 { SOL.A } 4	4	Orange	None
Station 4 { SOL.B } 17	17	Purple	None
Station 5 { SOL.A } 5	5	Yellow	None
Station 5 { SOL.B } 18	18	Gray	None
Station 6 { SOL.A } 6	6	Pink	None
Station 6 { SOL.B } 19	19	Orange	Black
Station 7 { SOL.A } 7	7	Blue	None
Station 7 { SOL.B } 20	20	Red	White
Station 8 { SOL.A } 8	8	Purple	White
Station 8 { SOL.B } 21	21	Brown	White
Station 9 { SOL.A } 9	9	Gray	Black
Station 9 { SOL.B } 22	22	Pink	Red
Station 10 { SOL.A } 10	10	White	Black
Station 10 { SOL.B } 23	23	Gray	Red
Station 11 { SOL.A } 11	11	White	Red
Station 11 { SOL.B } 24	24	Black	White
Station 12 { SOL.A } 12	12	Yellow	Red
Station 12 { SOL.B } 25	25	White	None
COM.	13	Orange	Red

Special Wiring Specifications (Options)

(For 25P)

Mixed single and double wiring are available as options. The maximum number of manifold stations is determined by the number of solenoids. Count one point for a single solenoid type and two points for a double solenoid type. The total number of solenoids (points) must not exceed 24.

Cable Assembly

AXT100-DS25-030
015
050

(D-sub connector cable assemblies can be ordered with manifolds.)
(Refer to manifold ordering.)

Lead wire colors for D-sub connector cable assembly terminal numbers

Terminal no.	Lead wire color	Dot marking
1	Black	None
2	Brown	None
3	Red	None
4	Orange	None
5	Yellow	None
6	Pink	None
7	Blue	None
8	Purple	White
9	Gray	Black
10	White	Black
11	White	Red
12	Yellow	Red
13	Orange	Red
14	Yellow	Black
15	Pink	Black
16	Blue	White
17	Purple	None
18	Gray	None
19	Orange	Black
20	Red	White
21	Brown	White
22	Pink	Red
23	Gray	Red
24	Black	White
25	White	None

D-sub connector cable assemblies

Cable length [L]	Part no.	Note
1.5 m	AXT100-DS25-015	Cable 0.3 mm ² x 25 cores
3 m	AXT100-DS25-030	
5 m	AXT100-DS25-050	

- * When using a standard commercial connector, use a type 25P female connector conforming to MIL-C-24308.
- * Cannot be used for transfer wiring.
- * Lengths other than the above is also available. Please contact SMC for details.

Electrical characteristics

Item	Characteristic
Conductor resistance Ω/km, 20°C	65 or less
Voltage limit V, 1 minute, AC	1000
Insulation resistance MΩ/km, 20°C	5 or more

(Note) The minimum bending radius for D-sub connector cables is 20 mm.

Connector Manufacturers Example

- Fujitsu, Limited
- Japan Aviation Electronics Industry, Limited
- J.S.T. Mfg. Co., Ltd.
- HIROSE ELECTRIC CO., LTD.

F VQC5000

Kit (D-sub connector kit) IP40 compliant

VV5QC51

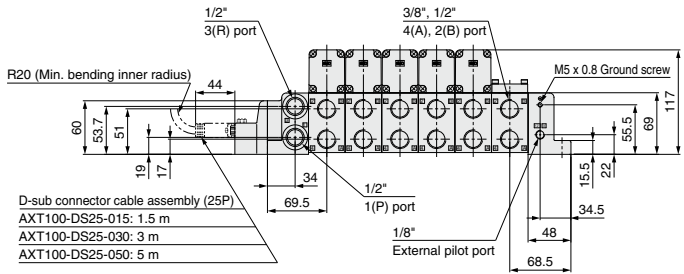
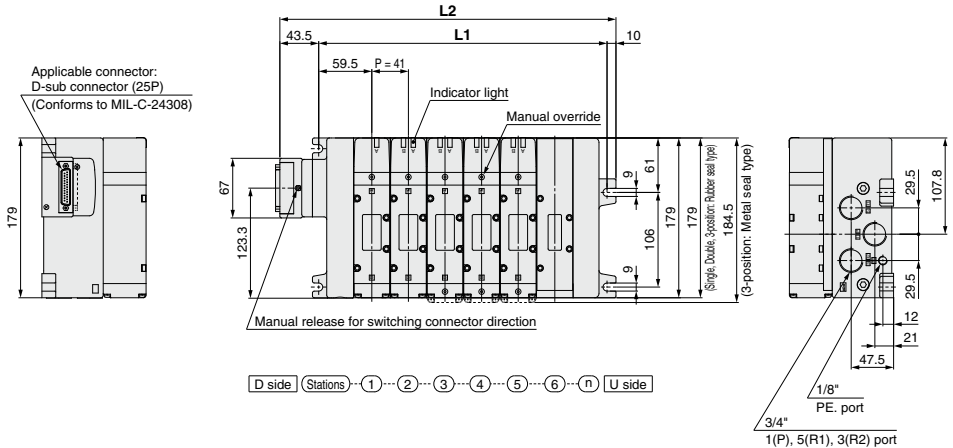

Bottom ported

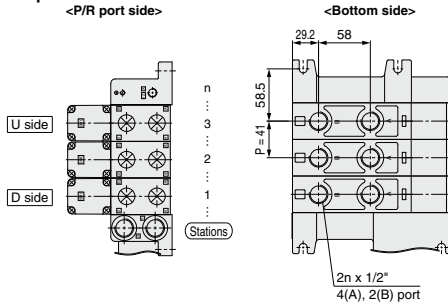

* Other dimensions are the same as the side ported type.

Dimensions

Formula: $L1 = 41n + 77$, $L2 = 41n + 130.5$ n: Stations (Maximum 12 stations)

n	1	2	3	4	5	6	7	8	9	10	11	12
L1	118	159	200	241	282	323	364	405	446	487	528	569
L2	171.5	212.5	253.5	294.5	335.5	376.5	417.5	458.5	499.5	540.5	581.5	622.5

- SV
- SYJ
- SZ
- VF
- VP4
- VQ 1/2
- VQ 4/5
- VQC 1/2
- VQC 4/5
- VQZ
- SQ
- VFS
- VFR
- VQ7

VQC5000 Series

P VQC5000 Kit (Flat ribbon cable kit) IP40 compliant

- Using our flat ribbon cable for electrical connections greatly reduces labor, while it also minimizes wiring and saves space.
- We use flat ribbon cables whose connectors (26P and 20P) conform to MIL standards, and are therefore widely compatible with many standard commercial models.
- Top or side entry for the connector can be changed freely, allowing for changes even after mounting, to meet any changing needs for space.

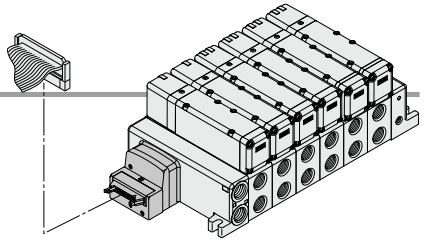

Electrical Wiring Specifications

Flat ribbon cable connector

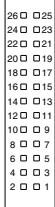

Double wiring (connected to SOL. A and SOL. B) is used for the internal wiring of each station regardless of valve and option types. Mixed single and double wiring are available as options. Refer to special wiring specifications (options) below.

Connector terminal number

Triangle mark indicator position

<26P>

<20P>

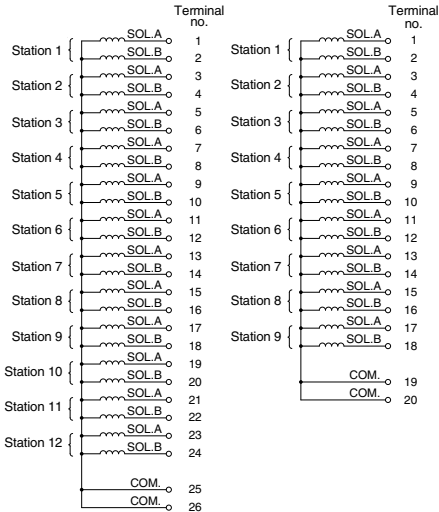

Cable Assembly

AXT100-FC $\frac{20}{26} - \frac{1}{2}$ 3

(Type 26P flat ribbon cable connector assemblies can be ordered with manifolds. Refer to manifold ordering.)

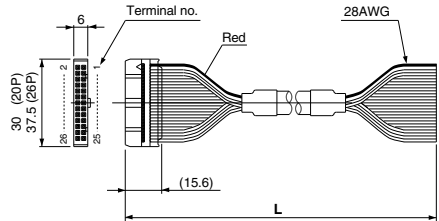

Flat ribbon cable connector assemblies

Cable length [L]	Part no.	
	26P	20P
1.5 m	AXT100-FC26-1	AXT100-FC20-1
3 m	AXT100-FC26-2	AXT100-FC20-2
5 m	AXT100-FC26-3	AXT100-FC20-3

- * When using a standard commercial connector, use a type 26P connector conforming to MIL-C-83503 or a type 20P with strain relief.
- * Cannot be used for transfer wiring.
- * Lengths other than the above is also available. Please contact SMC for details.

Connector Manufacturers Example

- HIROSE ELECTRIC CO., LTD.
- 3M Japan Limited
- Fujitsu, Limited
- Japan Aviation Electronics Industry, Limited
- J.S.T. Mfg. Co., Ltd.
- Oki Electric Cable Co., Ltd.

Special Wiring Specifications (Option)

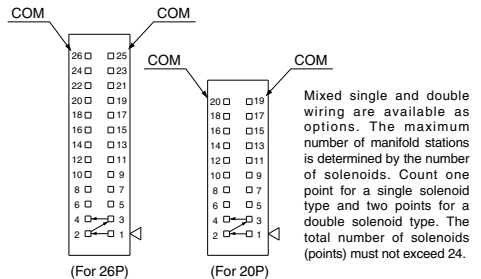

P VQC5000

Kit (Flat ribbon cable kit) IP40 compliant

VV5QC51

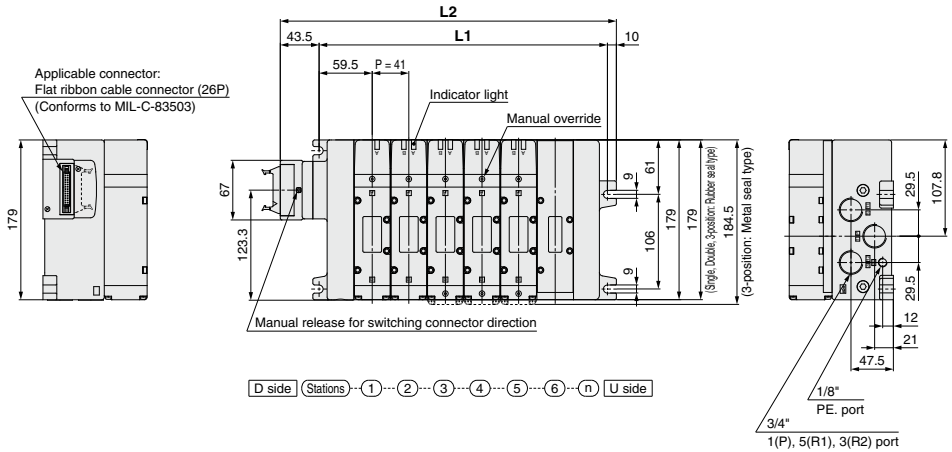

- SV
- SYJ
- SZ
- VF
- VP4
- VQ 1/2
- VQ 4/5
- VQC 1/2
- VQC 4/5
- VQZ
- SQ
- VFS
- VFR
- VQ7

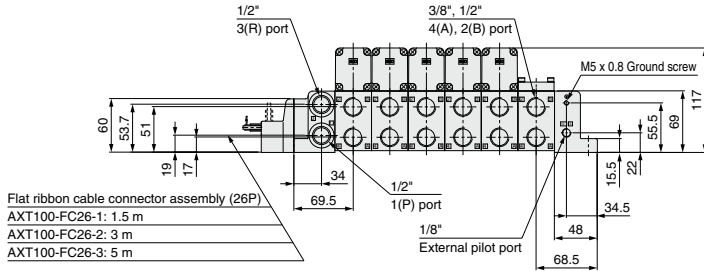

Bottom ported

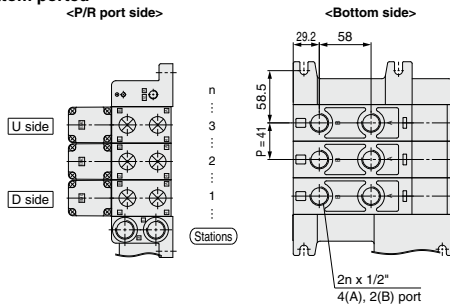

* Other dimensions are the same as the side ported type.

Dimensions

Formula: L1 = 41n + 77, L2 = 41n + 130.5 n: Stations (Maximum 12 stations)

L	n	1	2	3	4	5	6	7	8	9	10	11	12
L1		118	159	200	241	282	323	364	405	446	487	528	569
L2		171.5	212.5	253.5	294.5	335.5	376.5	417.5	458.5	499.5	540.5	581.5	622.5

VQC5000 Series

T VQC5000 Kit (Terminal block box kit) IP67 compliant

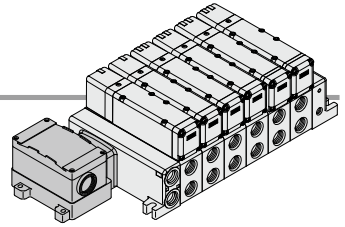

- This kit has a small terminal block inside a junction box. The provision of a G3/4 electrical entry allows connection of conduit fittings.

Terminal Block Connection

Step 1. How to remove terminal block cover

Loosen the 4 mounting screws (M4) and remove the terminal block cover.

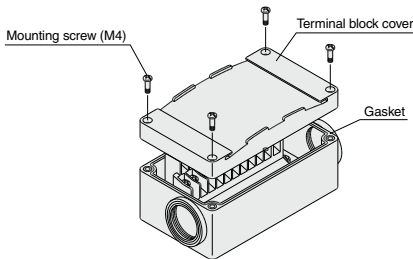

Step 3. How to replace the terminal block cover

Securely tighten the screws to the torque shown in the table below, after confirming that the gasket is installed correctly.

Proper tightening torque [N·m]
0.7 to 1.2

- Applicable crimped terminal: 1.25-3S, 1.25Y-3, 1.25Y-3N, 1.25Y-3.5
- Name plate: VVQ5000-N-T
- Drip proof plug assembly (for G3/4): AXT100-B06A

Step 2. The diagram below shows the terminal block wiring.

All stations are provided with double wiring regardless of the valves which are mounted.

Connect each wire to the power supply side, according to the markings provided inside the terminal block.

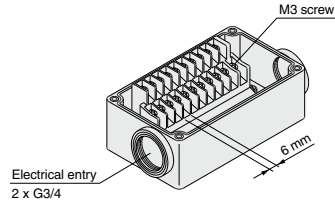

Electrical Wiring Specifications (Conforms to IP67)

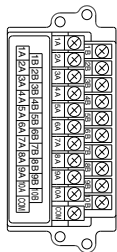

The internal wiring is double (connected to SOL. A and SOL. B) for all stations regardless of the type of valve or options. Mixed single and double wiring are available as options.

Standard wiring

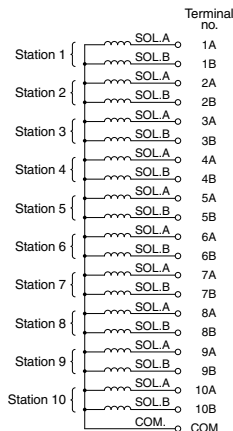

Special Wiring Specifications (Option)

Mixed single and double wiring are available as options. The maximum number of manifold stations is determined by the number of solenoids. Count one point for a single solenoid type and two points for a double solenoid type. The total number of solenoids (points) must not exceed 20.

1. How to Order

Indicate option symbol "K" in the manifold part number and be sure to specify station positions for single or double wiring on the manifold specification sheet.

2. Wiring specifications

Connector terminal numbers are connected from solenoid station 1 on the A side in the order indicated by the arrows without skipping any terminal numbers.

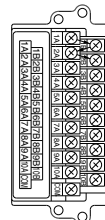

T VQC5000

Kit (Terminal block box kit) IP67 compliant

VV5QC51

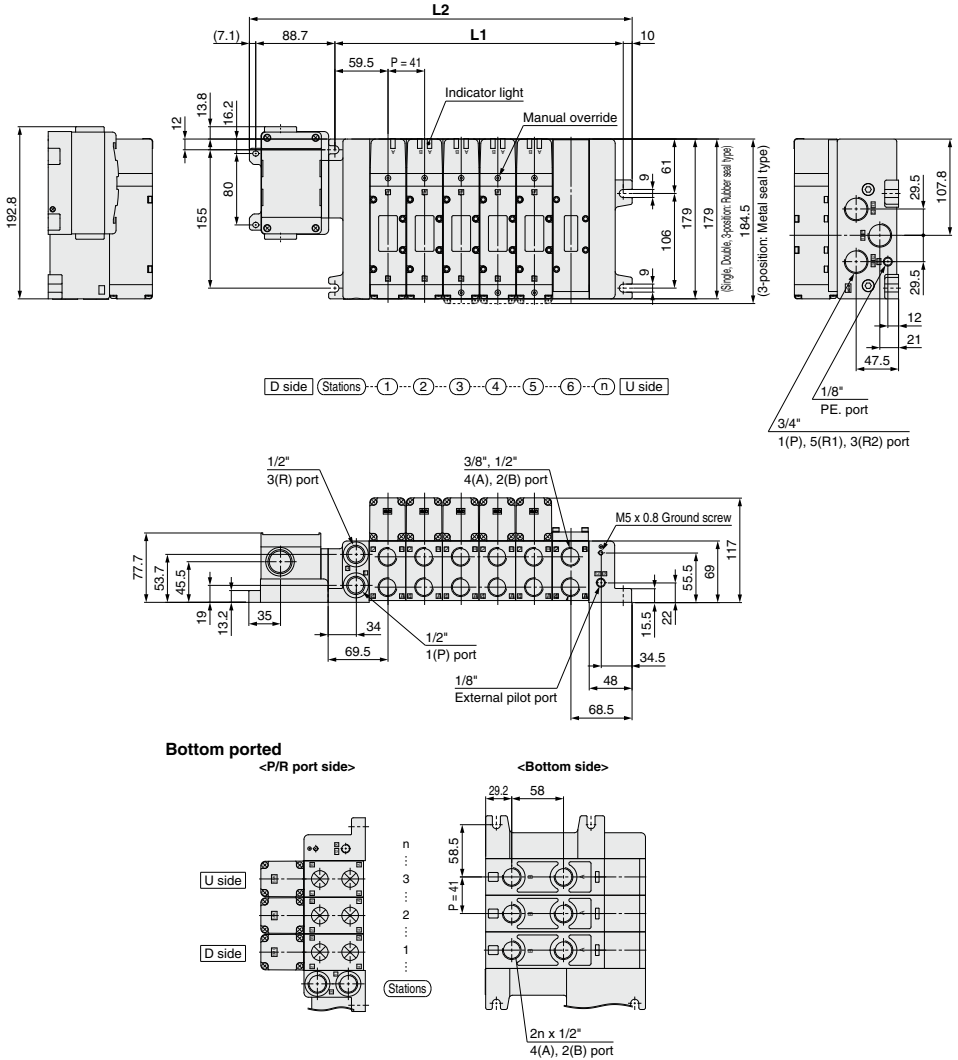

SV
SYJ
SZ
VF
VP4
VQ 1/2
VQ 4/5
VQC 1/2
VQC 4/5
VQZ
SQ
VFS
VFR
VQ7

Dimensions

Formula: L1 = 41n + 77, L2 = 41n + 182.8 n: Stations (Maximum 12 stations)

L	n	1	2	3	4	5	6	7	8	9	10	11	12
L1		118	159	200	241	282	323	364	405	446	487	528	569
L2		223.8	264.8	305.8	346.8	387.8	428.8	469.8	510.8	551.8	592.8	633.8	674.8

VQC5000 Series

L VQC5000 Kit (Lead wire kit) IP67 compliant

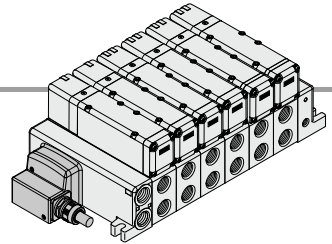

- Direct electrical entry type
- IP67 enclosure is available with use of cables with sheath and waterproof connectors.

Electrical Wiring Specifications

Lead wire specifications

Lead wire

0.3 mm² x 25 cores

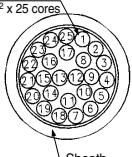

Sheath
Color: White

As the standard electrical wiring specification used is for 12 stations or less, double wiring (connected to SOL. A and SOL. B) is used for the internal wiring of each station regardless of valve and option types.

Mixed single and double wiring are available as options.

Refer to special wiring specifications (options) below.

Lead wire length

VV5QC51-08 C12 LD **0**

Lead wire length

0	0.6 m
1	1.5 m
2	3.0 m

Electrical characteristics

Item	Characteristic
Conductor resistance Ω/km, 20°C	65 or less
Withstand pressure V, 1 minute, AC	1000
Insulation resistance MΩ/km, 20°C	5 or more

Note) Cannot be used for transfer wiring.
The minimum bending radius for cables is 20 mm.

	Terminal no.	Lead wire color	Dot marking
Station 1	SOL.A	1 Black	None
	SOL.B	14 Yellow	Black
Station 2	SOL.A	2 Brown	None
	SOL.B	15 Pink	Black
Station 3	SOL.A	3 Red	None
	SOL.B	16 Blue	White
Station 4	SOL.A	4 Orange	None
	SOL.B	17 Purple	None
Station 5	SOL.A	5 Yellow	None
	SOL.B	18 Gray	None
Station 6	SOL.A	6 Pink	None
	SOL.B	19 Orange	Black
Station 7	SOL.A	7 Blue	None
	SOL.B	20 Red	White
Station 8	SOL.A	8 Purple	White
	SOL.B	21 Brown	White
Station 9	SOL.A	9 Gray	Black
	SOL.B	22 Pink	Red
Station 10	SOL.A	10 White	Black
	SOL.B	23 Gray	Red
Station 11	SOL.A	11 White	Red
	SOL.B	24 Black	White
Station 12	SOL.A	12 Yellow	Red
	SOL.B	25 White	None
	COM	13 Orange	Red

Special Wiring Specifications (Option)

Mixed single and double wiring are available as options. The maximum number of manifold stations is determined by the number of solenoids. Count one point for a single solenoid type and two points for a double solenoid type. The total number of solenoids (points) must not exceed 24.



VQC5000

Kit (Lead wire kit) IP67 compliant

VV5QC51

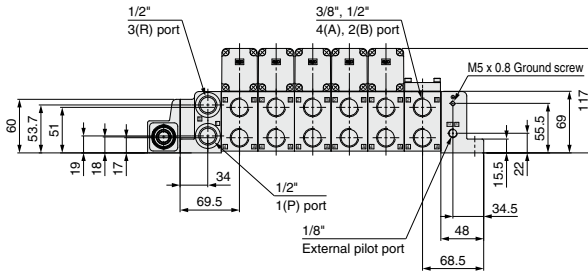
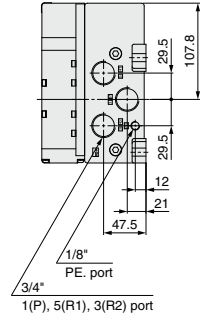
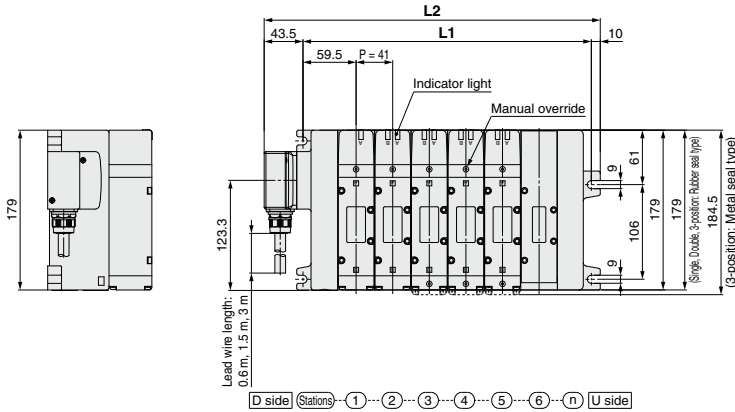

Bottom ported

<P/R port side>

<Bottom side>

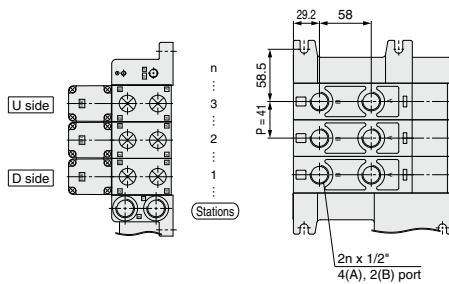

* Other dimensions are the same as the side ported type.

Dimensions

Formula: L1 = 41n + 77, L2 = 41n + 130.5 n: Stations (Maximum 12 stations)

L	n	1	2	3	4	5	6	7	8	9	10	11	12
L1		118	159	200	241	282	323	364	405	446	487	528	569
L2		171.5	212.5	253.5	294.5	335.5	376.5	417.5	458.5	499.5	540.5	581.5	622.5

- SV
- SYJ
- SZ
- VF
- VP4
- VQ 1/2
- VQ 4/5
- VQC 1/2
- VQC 4/5
- VQZ
- SQ
- VFS
- VFR
- VQ7

VQC5000 Series

M VQC5000 Kit (Circular connector kit) IP67 compliant

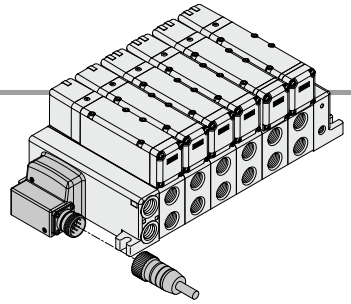

- Use of circular connectors helps streamline wiring procedure to save labor.
- IP67 enclosure is available with use of waterproof multiple connectors.

Electrical Wiring Specifications

Multiple connector

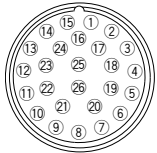

Double wiring (connected to SOL.A and SOL.B) is used for the internal wiring of each station regardless of valve and option types. Mixed single and double wiring are available as options. Refer to special wiring specifications (options) below.

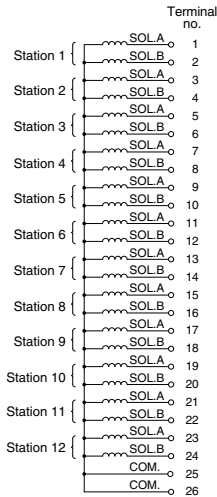

Special Wiring Specifications (Option)

Mixed single and double wiring are available as options. The maximum number of manifold stations is determined by the number of solenoids. Count one point for a single solenoid type and two points for a double solenoid type. The total number of solenoids (points) must not exceed 24.

Cable Assembly

AXT100-MC26-030
015
050

(Type 26P circular connector cable assemblies can be ordered with manifolds. Refer to manifolds ordering.)

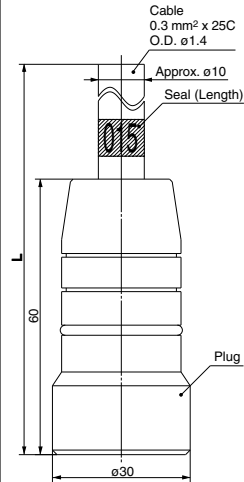

Lead wire colors for circular connector cable assembly terminal numbers

Terminal no.	Lead wire color	Dot marking
1	Black	None
2	Brown	None
3	Red	None
4	Orange	None
5	Yellow	None
6	Pink	None
7	Blue	None
8	Purple	White
9	Gray	Black
10	White	Black
11	White	Red
12	Yellow	Red
13	Orange	Red
14	Yellow	Black
15	Pink	Black
16	Blue	White
17	Purple	None
18	Gray	None
19	Orange	Black
20	Red	White
21	Brown	White
22	Pink	Red
23	Gray	Red
24	Black	White
25	White	None
26	White	None

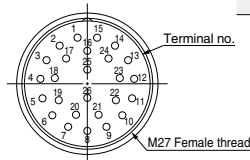

Electric characteristics

Item	Property
Conductor resistance Ω/km, 20°C	65 or less
Voltage limit V, 1 minute, AC	1000
Insulation resistance MΩ/km, 20°C	5 or more

(Note) The minimum bending radius of the multiple connector cable is 20 mm.

Circular connector cable assemblies

Cable length [L]	Assembly part no.
	26P
1.5 m	AXT100-MC26-015
3 m	AXT100-MC26-030
5 m	AXT100-MC26-050

- * Cannot be used for transfer wiring.
- * Lengths other than the above is also available. Please contact SMC for details.



VQC5000

Kit (Circular connector kit) IP67 compliant

VV5QC51

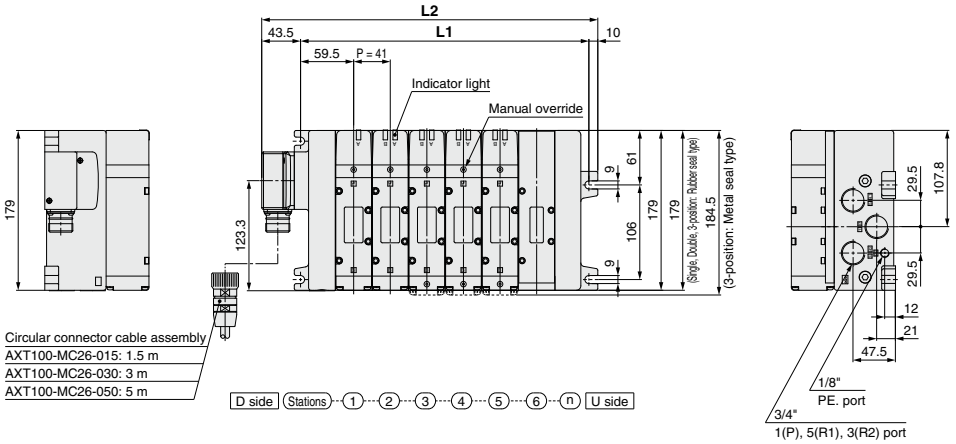

- SV
- SYJ
- SZ
- VF
- VP4
- VQ 1/2
- VQ 4/5
- VQC 1/2
- VQC 4/5
- VQZ
- SQ
- VFS
- VFR
- VQ7

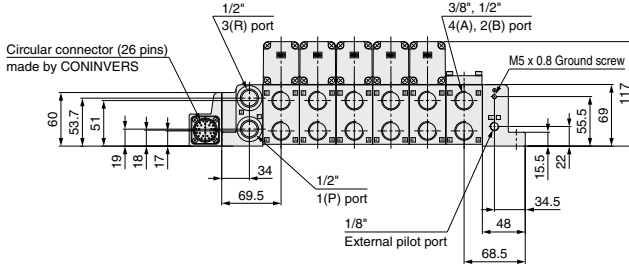

Bottom ported

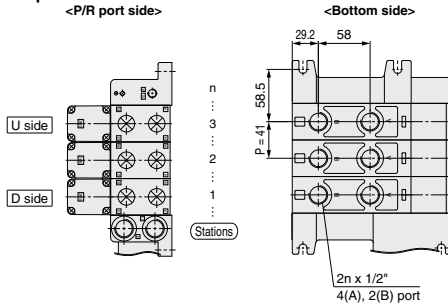

* Other dimensions are the same as the side ported type.

Dimensions

Formula: L1 = 41n + 77, L2 = 41n + 130.5 n: Stations (Maximum 12 stations)

L	n	1	2	3	4	5	6	7	8	9	10	11	12
L1		118	159	200	241	282	323	364	405	446	487	528	569
L2		171.5	212.5	253.5	294.5	335.5	376.5	417.5	458.5	499.5	540.5	581.5	622.5



VQC5000 Series Construction

Plug-in Unit

Metal seal type

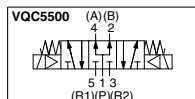
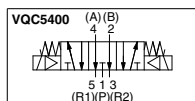
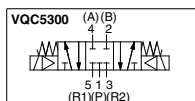
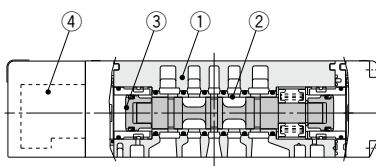
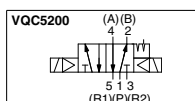
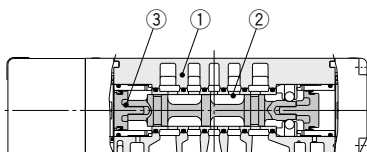
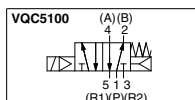
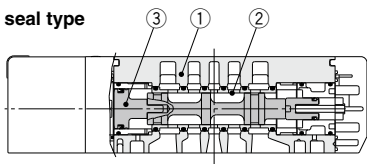

Rubber seal type

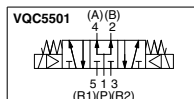
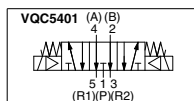
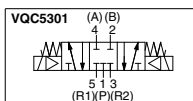
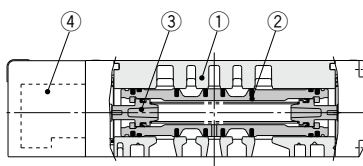
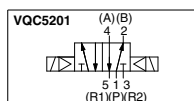
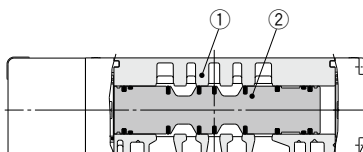
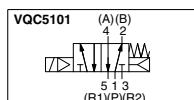
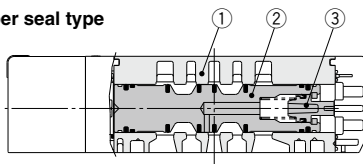

Component Parts

No.	Description	Material	Note
1	Body	Aluminum die-casted	
2	Spool/Sleeve	Stainless steel	
3	Piston	Resin	

Replacement Parts

4	Pilot valve assembly	V118 □ □ □ □ A B E	<input type="checkbox"/> Coil rated voltage Example) 24 VDC; 5 A: With light (For A side) B: With light (For B side) E: Without light (A/B side common)
		Coil type <input type="checkbox"/> Nil Standard (0.95 W) <input type="checkbox"/> Y Low wattage type (0.4 W)	

Component Parts

No.	Description	Material	Note
1	Body	Aluminum die-casted	
2	Spool valve	Aluminum, HNBR	
3	Piston	Resin	

Replacement Parts

4	Pilot valve assembly	V118 □ □ □ □ A B E	<input type="checkbox"/> Coil rated voltage Example) 24 VDC; 5 A: With light (For A side) B: With light (For B side) E: Without light (A/B side common)
		Coil type <input type="checkbox"/> Nil Standard (0.95 W) <input type="checkbox"/> Y Low wattage type (0.4 W)	

VQC5000 Series

Exploded View of Manifold

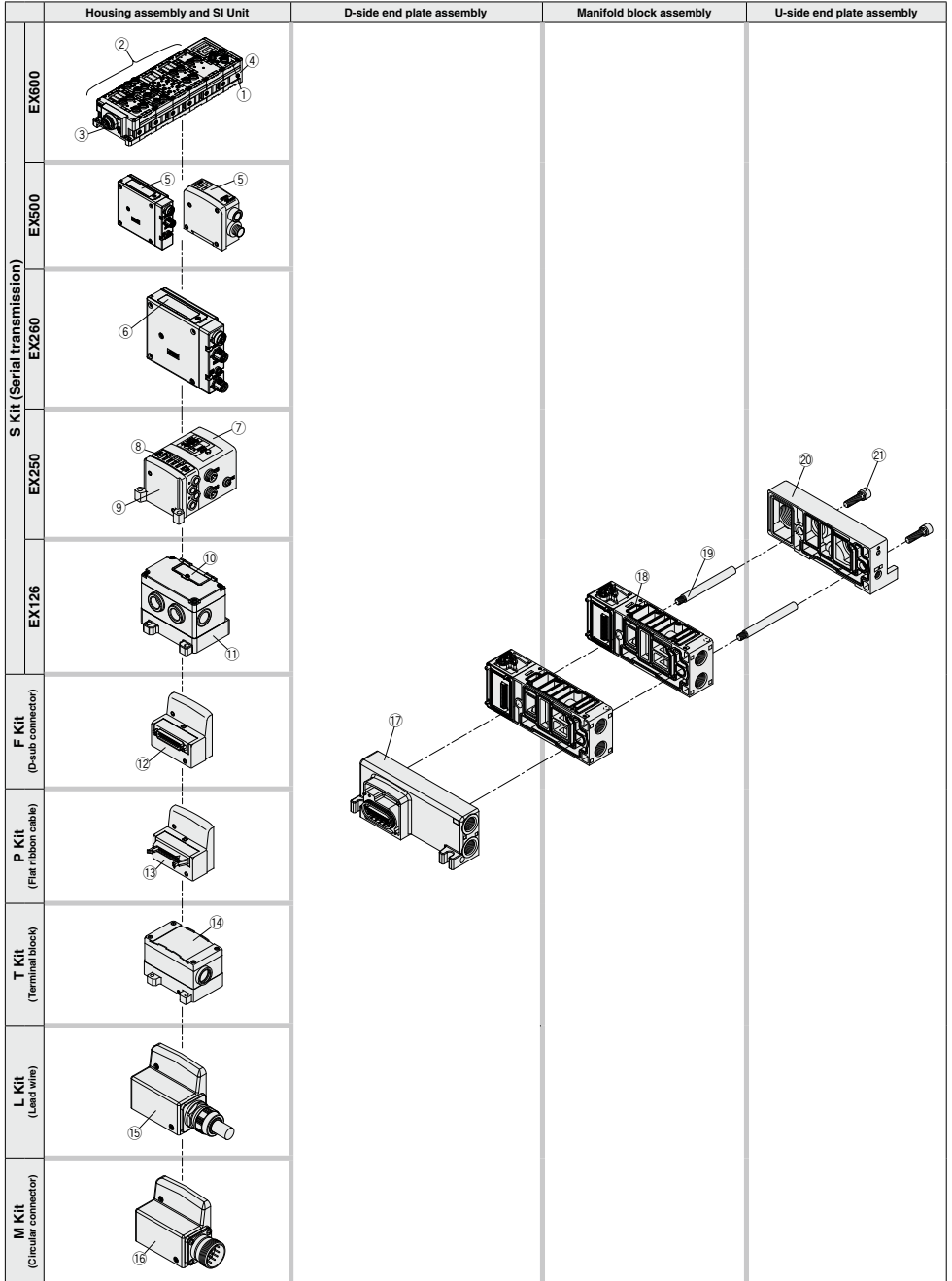

- SV
- SYJ
- SZ
- VF
- VP4
- VQ 1/2
- VQ 4/5
- VQC 1/2
- VQC 4/5**
- VQZ
- SQ
- VFS
- VFR
- VQ7

VQC5000 Series

Manifold Assembly Part No.

Housing Assembly and SI Unit/Input Block

No.	Description	Part no.	Note	
①	SI Unit	EX600-SDN1A	DeviceNet™, Negative common (PNP)	
		EX600-SDN2A	DeviceNet™, Positive common (NPN)	
		EX600-SMJ1	CC-Link, Negative common (PNP)	
		EX600-SMJ2	CC-Link, Positive common (NPN)	
		EX600-SPR1A	PROFIBUS DP, Negative common (PNP)	
		EX600-SPR2A	PROFIBUS DP, Positive common (NPN)	
		EX600-SEN1	EtherNet/IP™ (1 port), Negative common (PNP)	
		EX600-SEN2	EtherNet/IP™ (1 port), Positive common (NPN)	
		EX600-SEN3	EtherNet/IP™ (2 port), Negative common (PNP)	
		EX600-SEN4	EtherNet/IP™ (2 port), Positive common (NPN)	
		EX600-SPN1	PROFINET, Negative common (PNP)	
		EX600-SPN2	PROFINET, Positive common (NPN)	
		EX600-SEC1	EtherCAT, Negative common (PNP)	
		EX600-SEC2	EtherCAT, Positive common (NPN)	
		EX600-WEN1 ^{Note)}	Wireless base module EtherNet/IP™ Negative common (PNP)	
		EX600-WEN2 ^{Note)}	Wireless base module EtherNet/IP™ Positive common (NPN)	
		EX600-WPN1 ^{Note)}	Wireless base module PROFINET Negative common (PNP)	
		EX600-WPN2 ^{Note)}	Wireless base module PROFINET Positive common (NPN)	
		EX600-WSV1 ^{Note)}	Wireless remote module Negative common (PNP)	
		EX600-WSV2 ^{Note)}	Wireless remote module Positive common (NPN)	
②	Digital Input Unit	EX600-DXNB	NPN input, M12 connector, 5 pins (4 pcs.), 8 inputs	
		EX600-DXPB	PNP input, M12 connector, 5 pins (4 pcs.), 8 inputs	
		EX600-DXNC	NPN input, M8 connector, 3 pins (8 pcs.), 8 inputs	
		EX600-DXNC1	NPN input, M8 connector, 3 pins (8 pcs.), 8 inputs, with open circuit detection	
		EX600-DXPC	PNP input, M8 connector, 3 pins (8 pcs.), 8 inputs	
		EX600-DXPC1	PNP input, M8 connector, 3 pins (8 pcs.), 8 inputs, with open circuit detection	
		EX600-DXND	NPN input, M12 connector, 5 pins (8 pcs.), 16 inputs	
		EX600-DXPD	PNP input, M12 connector, 5 pins (8 pcs.), 16 inputs	
		EX600-DXNE	NPN input, D-sub connector, 25 pins, 16 inputs	
		EX600-DXPE	PNP input, D-sub connector, 25 pins, 16 inputs	
		EX600-DXNF	NPN input, Spring type terminal box, 32 pins, 16 inputs	
		EX600-DXPF	PNP input, Spring type terminal box, 32 pins, 16 inputs	
		Digital Output Unit	EX600-DYNB	NPN output, M12 connector, 5 pins (4 pcs.), 8 outputs
			EX600-DYPB	PNP output, M12 connector, 5 pins (4 pcs.), 8 outputs
			EX600-DYNE	NPN output, D-sub connector, 25 pins, 16 outputs
			EX600-DYPE	PNP output, D-sub connector, 25 pins, 16 outputs
			EX600-DYNF	NPN output, Spring type terminal box, 32 pins, 16 outputs
	EX600-DYPF		PNP output, Spring type terminal box, 32 pins, 16 outputs	
	Digital Input/Output Unit	EX600-DMNE	NPN input/output, D-sub connector, 25 pins, 8 inputs/outputs	
		EX600-DMPE	PNP input/output, D-sub connector, 25 pins, 8 inputs/outputs	
		EX600-DMNF	NPN input/output, Spring type terminal box, 32 pins, 8 inputs/outputs	
		EX600-DMPF	PNP input/output, Spring type terminal box, 32 pins, 8 inputs/outputs	
	Analog Input Unit		EX600-AXA	M12 connector, 5 pins (2 pcs.), 2-channel input
	Analog Output Unit		EX600-AYA	M12 connector, 5 pins (2 pcs.), 2-channel output
	Analog Input/Output Unit		EX600-AMB	M12 connector, 5 pins (4 pcs.), 2-channel input/output
	③	End plate	EX600-ED2	M12 power supply connector, B-coded
			EX600-ED3	7/8 inch power supply connector
EX600-ED4			M12 power supply connector IN/OUT, A-coded, Pin arrangement 1	
EX600-ED5			M12 power supply connector IN/OUT, A-coded, Pin arrangement 2	
④	Valve plate	EX600-ZMV1	Enclosed parts: Round head screws (M4 x 6) 2 pcs., Round head screws (M3 x 8) 4 pcs.	
⑤	SI Unit	EX500-S103	EtherNet/IP™, PROFINET, Negative common (PNP)	
		EX500-Q001	DeviceNet™, PROFIBUS DP, EtherNet/IP™, Positive common (NPN)	
		EX500-Q101	DeviceNet™, PROFIBUS DP, EtherNet/IP™, Negative common (PNP)	

Note) The wireless system is suitable for use only in a country where it is in accordance with the Radio Act and regulations of that country.

Manifold Assembly Part No.

Housing Assembly and SI Unit/Input Block

No.	Description	Part no.	Note
⑥	SI Unit	EX260-SDN1	DeviceNet™, M12 connector, 32 outputs, Negative common (PNP)
		EX260-SDN2	DeviceNet™, M12 connector, 32 outputs, Positive common (NPN)
		EX260-SDN3	DeviceNet™, M12 connector, 16 outputs, Negative common (PNP)
		EX260-SDN4	DeviceNet™, M12 connector, 16 outputs, Positive common (NPN)
		EX260-SRP1	PROFIBUS DP, M12 connector, 32 outputs, Negative common (PNP)
		EX260-SRP2	PROFIBUS DP, M12 connector, 32 outputs, Positive common (NPN)
		EX260-SRP3	PROFIBUS DP, M12 connector, 16 outputs, Negative common (PNP)
		EX260-SRP4	PROFIBUS DP, M12 connector, 16 outputs, Positive common (NPN)
		EX260-SRP5	PROFIBUS DP, D-sub connector, 32 outputs, Negative common (PNP)
		EX260-SRP6	PROFIBUS DP, D-sub connector, 32 outputs, Positive common (NPN)
		EX260-SRP7	PROFIBUS DP, D-sub connector, 16 outputs, Negative common (PNP)
		EX260-SRP8	PROFIBUS DP, D-sub connector, 16 outputs, Positive common (NPN)
		EX260-SMJ1	CC-Link, M12 connector, 32 outputs, Negative common (PNP)
		EX260-SMJ2	CC-Link, M12 connector, 32 outputs, Positive common (NPN)
		EX260-SMJ3	CC-Link, M12 connector, 16 outputs, Negative common (PNP)
		EX260-SMJ4	CC-Link, M12 connector, 16 outputs, Positive common (NPN)
		EX260-SEC1	EtherCAT, M12 connector, 32 outputs, Negative common (PNP)
		EX260-SEC2	EtherCAT, M12 connector, 32 outputs, Positive common (NPN)
		EX260-SEC3	EtherCAT, M12 connector, 16 outputs, Negative common (PNP)
		EX260-SEC4	EtherCAT, M12 connector, 16 outputs, Positive common (NPN)
		EX260-SPN1	PROFINET, M12 connector, 32 outputs, Negative common (PNP)
		EX260-SPN2	PROFINET, M12 connector, 32 outputs, Positive common (NPN)
		EX260-SPN3	PROFINET, M12 connector, 16 outputs, Negative common (PNP)
		EX260-SPN4	PROFINET, M12 connector, 16 outputs, Positive common (NPN)
		EX260-SEN1	EtherNet/IP™, M12 connector, 32 outputs, Negative common (PNP)
		EX260-SEN2	EtherNet/IP™, M12 connector, 32 outputs, Positive common (NPN)
		EX260-SEN3	EtherNet/IP™, M12 connector, 16 outputs, Negative common (PNP)
		EX260-SEN4	EtherNet/IP™, M12 connector, 16 outputs, Positive common (NPN)
		EX260-SPL1	Ethernet POWERLINK, M12 connector, 32 outputs, Negative common (PNP)
		EX260-SPL3	Ethernet POWERLINK, M12 connector, 16 outputs, Negative common (PNP)
		EX260-SIL1	IO-Link, M12 connector, 32 outputs, Negative common (PNP)
		⑦	SI Unit
EX250-SAS3	AS-Interface, 8 in/8 out, 31 slave modes, 2 power supply systems, Negative common (PNP)		
EX250-SAS5	AS-Interface, 4 in/4 out, 31 slave modes, 2 power supply systems, Negative common (PNP)		
EX250-SAS7	AS-Interface, 8 in/8 out, 31 slave modes, 1 power supply system, Negative common (PNP)		
EX250-SAS9	AS-Interface, 4 in/4 out, 31 slave modes, 1 power supply system, Negative common (PNP)		
EX250-SCA1A	CANopen, Negative common (PNP)		
EX250-SDN1	DeviceNet™, Negative common (PNP)		
EX250-SEN1	EtherNet/IP™, Negative common (PNP)		
⑧	Input block	EX250-IE1	M12, 2 inputs
		EX250-IE2	M12, 4 inputs
		EX250-IE3	M8, 4 inputs
⑨	End plate assembly	EX250-EA1	Direct mounting
		EX250-EA2	DIN rail mounting
⑩	SI Unit	EX126D-SMJ1	CC-Link, Positive common (NPN)
⑪	Terminal block plate	VVQC1000-74A-2	For EX126 SI Unit mounting
⑫	D-sub connector housing assembly	VVQC1000-F25-1	F kit, 25 pins
		VVQC1000-P26-1	P kit, 26 pins
⑬	Flat ribbon cable housing assembly	VVQC1000-P20-1	P kit, 20 pins
		VVQC1000-T0-1	T kit
⑭	Terminal block box housing assembly	VVQC1000-L25-0-1	L kit with 0.6 m lead wire
		VVQC1000-L25-1-1	L kit with 1.5 m lead wire
		VVQC1000-L25-2-1	L kit with 3.0 m lead wire
⑮	Lead wire housing assembly	VVQC1000-M26-1	M kit, 26 pins

SV

SYJ

SZ

VF

VP4

VQ

1/2

VQ

4/5

VQC

1/2

VQC

4/5

VQZ

SQ

VFS

VFR

VQ7

VQC5000 Series

Manifold Assembly Part No.

D-side end plate assembly

⑰ D-side end plate assembly part no.

VVQC5000-3A-2

• Thread type

Nil	Rc
F	G
T	NPTF
N	NPT

U-side end plate assembly

⑱ U-side end plate assembly part no.

VVQ5000-2A-1 -L-W

• Thread type

Nil	Rc
F	G
T	NPTF
N	NPT

Manifold block assembly

⑳ Manifold block assembly part no.

VVQC5000-1 **A** - **D** - **C6**

• Type

A For 1 station

Note) Tie-rods (2 pcs.) for additional stations included.

• Wiring specifications

<input type="checkbox"/> D	Double wiring
<input type="checkbox"/> S	Single wiring

• Thread type (Thread port only)

Nil	Rc
F	G
T	NPTF
N	NPT

• Port size

Symbol	Port size
<input type="checkbox"/> 03	3/8"
<input type="checkbox"/> 04	1/2"
<input type="checkbox"/> B	1/2" bottom ported



㉑ Tie-rod assembly part no. (2 units)

VQC5000 VVQC5000-TR-

Note 1) Please order when reducing the number of manifold stations. When increasing the number of stations, additional orders are not required since they are included in the manifold block assembly.

Note 2) Number of stations, 02 to 16

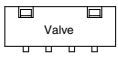
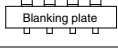
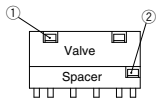
List of Valves, Options, and Mounting Bolts

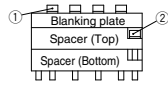
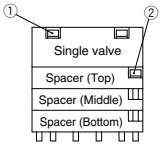
Number of options	Valve and options	Bolt part no.	Qty (pcs)	Note	Option mounting diagram	
0	Single valve	AXT632-25-4 (M4 x 50)	4			
	Blanking plate (VVQ5000-10A- $\frac{1}{2}$)	AXT632-25-8 (M4 x 17)	4	For manifold		
1	Valve + Individual SUP spacer (VVQ5000-P- $\frac{1}{5}$ - $\frac{03}{03}$)	① AXT632-25-5 (M4 x 82) ② AXT632-25-10 (M4 x 34)	4 2	For manifold		
	Valve + Individual EXH spacer (VVQ5000-R- $\frac{1}{5}$ - $\frac{03}{03}$)	① AXT632-25-5 (M4 x 82) ② AXT632-25-10 (M4 x 34)	4 2	For manifold		
	Valve + Restrictor spacer (VVQ5000-20A- $\frac{1}{5}$)	① AXT632-25-5 (M4 x 82) ② AXT632-25-10 (M4 x 34)	4 2	Not necessary when mounting the sub-plate.		
	Valve + Release valve spacer (VVQ5000-24A- $\frac{1}{5}$ D)	① AXT632-25-5 (M4 x 82) ② AXT632-25-10 (M4 x 34)	4 2	For manifold		
	Valve + Double check spacer with residual pressure exhaust (VVQ5000-25A- $\frac{1}{5}$)	① AXT632-25-6 (M4 x 114) ② AXT632-66-1 (M4 x 64)	4 2	Not necessary when mounting the sub-plate.		
	Valve + SUP stop valve spacer (VVQ5000-37A- $\frac{1}{5}$)	① AXT632-25-5 (M4 x 82) ② AXT632-25-10 (M4 x 34)	4 2	Not necessary when mounting the sub-plate.		
	Valve + Interface regulator (ARBQ5000-00- $\frac{A}{C}$ - $\frac{1}{5}$)	① AXT632-25-6 (M4 x 114) ② AXT632-66-1 (M4 x 64)	4 2	Not necessary when mounting the sub-plate.		
	Blanking plate + SUP stop valve (Top) (Bottom)	① AXT632-25-4 (M4 x 50)	4	For manifold		
		② AXT632-25-10 (M4 x 34)	2			
	2	Valve + Individual SUP + Individual EXH (Top) (Bottom) (Bottom) (Top)	① AXT632-25-6 (M4 x 114) ② AXT632-25-11 (M4 x 66)	4 2		For manifold
Valve + Restrictor + Individual SUP or Individual EXH (Top) (Bottom) (Top) (Bottom)		① AXT632-25-6 (M4 x 114) ② AXT632-25-11 (M4 x 66)	4 2	For manifold * The individual EXH cannot be mounted on the top.		
Valve + SUP stop valve + Individual SUP, Individual EXH or Restrictor (Bottom)		① AXT632-25-6 (M4 x 114) ② AXT632-25-11 (M4 x 66)	4 2	For manifold		
Valve + Double check spacer with residual pressure exhaust (Top) Individual EXH (Bottom)		① AXT632-25-7 (M4 x 146) ② AXT632-66-2 (M4 x 96)	4 2	For manifold		
Valve + Interface regulator + Double check spacer with residual pressure exhaust (Top) (Bottom)		① AXT632-25-14 (M4 x 178) ② AXT632-66-3 (M4 x 128)	4 2	For manifold		
Valve + Interface regulator + Individual SUP, Individual EXH or Restrictor (Bottom)		① AXT632-25-7 (M4 x 146) ② AXT632-66-2 (M4 x 96)	4 2	For manifold * The individual EXH and restrictor can be mounted on the top.		
Blanking plate + SUP stop valve (Top) + Individual SUP (Bottom)		① AXT632-25-5 (M4 x 82)	4	For manifold		
		② AXT632-25-11 (M4 x 66)	2			
3	Valve + SUP stop valve (Top) + Individual SUP (Middle, Bottom) + Individual EXH (Middle, Bottom)	① AXT632-25-7 (M4 x 146) ② AXT632-25-12 (M4 x 98)	4 2	For manifold		
	Valve + Double check spacer with residual pressure exhaust (Top) + Individual SUP (Middle, Bottom) + Individual EXH (Middle, Bottom)	① AXT632-25-14 (M4 x 178) ② AXT632-66-3 (M4 x 128)	4 2	For manifold		
	Valve + Spacer (Top): Interface regulator Spacer (Middle); "Individual SUP or Individual EXH"/"Restrictor" Spacer (Bottom); "Restrictor"/"Individual SUP or Individual EXH"	① AXT632-25-14 (M4 x 178) ② AXT632-66-3 (M4 x 128)	4 2	For manifold * The individual EXH and restrictor can be mounted on the top.		

Note) When the SUP stop valve and individual SUP are mounted, the stop valve is mounted on the top of the individual SUP.

SV
 SYJ
 SZ
 VF
 VP4
 VQ 1/2
 VQ 4/5
 VQC 1/2
 VQC 4/5
 VQZ
 SQ
 VFS
 VFR
 VQ7



VQC5000 Series Specific Product Precautions 1

Be sure to read this before handling the products.
Refer to back page 50 for Safety Instructions and pages 3 to 9 for 3/4/5 Port Solenoid Valve Precautions.

Continuous Duty

⚠ Warning

When the product is continuously energized for a long period of time (10 minutes or longer), select the low wattage type (DC specification). The AC type cannot be continuously energized for 10 minutes or longer. If anything is unclear, please contact SMC.

Manual Override

⚠ Warning

Since connected equipment will operate when the manual override is activated, confirm that conditions are safe prior to activation.

■ VQC5000

Push type (Tool required)

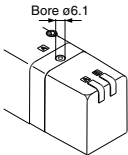

Push down the manual override button with a small screwdriver, etc., until it stops. The manual override will return when released.

Locking type (Tool required)

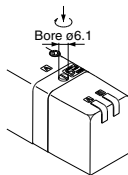

Push down the manual override button with a small flat head screwdriver until it stops, and turn it clockwise 90° to lock it. Turn it counterclockwise to release it.

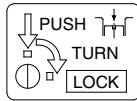

Locking type (Manual)

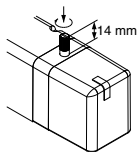

Push down the manual override button with a small flat head screwdriver or with your finger until it stops, and turn it clockwise 90° to lock it. Turn it counterclockwise to release it.

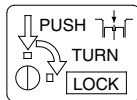

⚠ Caution

Do not apply excessive torque when turning the locking type manual override. (0.1 N·m or less)

Valve Mounting

⚠ Caution

After confirming that the gasket is installed correctly, securely tighten the mounting screws according to the tightening torque shown below.

Proper tightening torque [N·m]
1 to 1.8

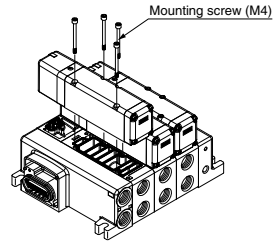

Lead Wire Connection

⚠ Caution

Plug-in sub-plate (With terminal block)

- If the junction cover ① of the sub-plate is removed, you can see the plug-in type terminal block ② mounted inside the sub-plate.

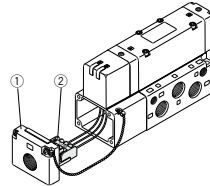

- The terminal block is marked as follows. Connect wiring to each of the power supply terminals.

Model	Terminal block marking	A	COM	B	\bar{T}
VQC510 ⁰		A side	COM	—	—
VQC520 ⁰		A side	COM	B side	—
VQC5 ³ / ₅ 0 ⁰ ₁		A side	COM	B side	—

Note 1) There is no polarity. It can also be used as -COM.

Note 2) The sub-plate is double wired even for the VQC510⁰.

- Applicable terminal: 1.25-3s, 1.25Y-3, 1.25Y-3N, 1.25Y-3.5



VQC5000 Series Specific Product Precautions 2

Be sure to read this before handling the products.
Refer to back page 50 for Safety Instructions and pages 3 to 9 for 3/4/5 Port Solenoid Valve Precautions.

Installation and Removal of Light Cover

⚠ Caution

Installation/Removal of light cover

• Removal

To remove the pilot cover pull it straight off. If it is pulled off at an angle, the pilot valve may be damaged or the protective O-ring may be scratched.

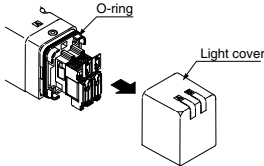

• Installation

Place the cover straight over the pilot assembly so that the pilot valve is not touched, and push it until the cover hook locks without twisting the protective O-ring. (When pushed in, the hook opens and locks automatically.)

Replacement of Pilot Valve

⚠ Caution

• Removal

1) Remove the mounting screw that holds the pilot valve using a small screwdriver.

• Installation

1) After confirming the gasket is correctly placed under the valve, securely tighten the bolts with the proper torque shown in the table below.

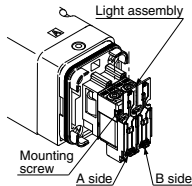

Proper tightening torque [N·m]
0.1 to 0.13

Plug Lead Type

Attaching and detaching connectors

- To attach a connector, hold the lever and connector unit between your fingers and insert straight onto the pins of the solenoid valve so that the lever's pawl is pushed into the groove and locks.
- To detach a connector, remove the pawl from the groove by pushing the lever downward with your thumb, and pull the connector straight out.

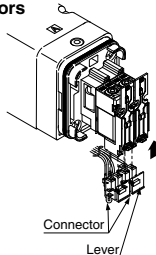

Note) Do not pull on the lead wires with excessive force. This can cause faulty and/or broken contacts.

Internal Wiring Specifications

⚠ Caution

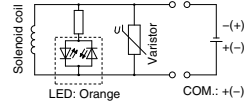

DC: Single

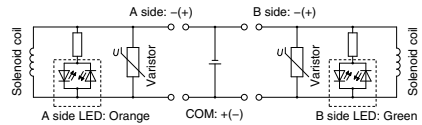

DC: Double

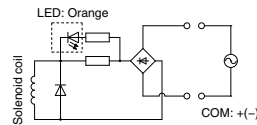

AC: Single

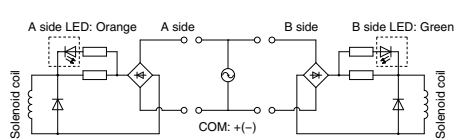

AC: Double

How to Calculate the Flow Rate

For obtaining the flow rate, refer to front matter.

■ Trademark

DeviceNet™ is a trademark of ODVA.
EtherNet/IP™ is a trademark of ODVA.
EtherCAT® is registered trademark and patented technology, licensed by Beckhoff Automation GmbH, Germany.

SV
SYJ
SZ
VF
VP4
VQ 1/2
VQ 4/5
VQC 1/2
VQC 4/5
VQZ
SQ
VFS
VFR
VQ7