

Insert Fittings

KF Series

A reliable seal Holds the tube tightly

Insert

An insert mechanism can provide reliable retaining force on tubes made of a wide variety of materials

Tube grip (resin sleeve)

- Tube is easily held by a unique configuration
- Slipping and dropping of sleeve and union nut is prevented

Superior tube mounting

Union nut

- No need to remove nuts
- Tube can be installed as-is

Tube holder

- Prevents tubes from being disconnected during piping.
- A strong feeling when inserting tube

Sleeve

- Light tightening torque
- Can be used from medium vacuum up to 1 MPa

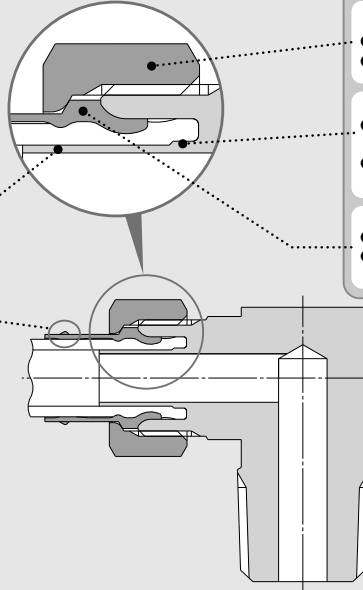

- Material / Body, Union nut: Brass
Sleeve: Resin or Brass
- Maximum operating temperature / **150°C** (Brass sleeve)
60°C (Resin sleeve)
- Applicable tubing material /
FEP • PFA • Modified PTFE • Nylon
Soft nylon • Polyurethane
Polyolefin • Soft polyolefin
- Can be used with steam. (For brass sleeve)
- Grease-free



KQ2

KQB2

KS
KX

KM

KF

M

H/DL
L/LL

KC

KK

KK130

DM

KDM

KB

KR

KA

KQG2

KG

KFG2

MS

KKA

KP

LQ

MQR

T

IDK

Male Connector

Use to connect tubes in the same direction from female thread. Most general type.

Applicable tubing size (mm)		Connection thread	Model	
O.D.	I.D.		Resin sleeve	Brass sleeve
ø4	ø2.5	R1/8	KFH04-01S	KFH04B-01S
		R1/4	KFH04-02S	KFH04B-02S
		R1/8	KFH06-01S	KFH06B-01S
ø6	ø4	R1/4	KFH06-02S	KFH06B-02S
		R3/8	KFH06-03S	KFH06B-03S
		R1/8	KFH08U-01S	—
ø8	ø5	R1/4	KFH08U-02S	—
		R3/8	KFH08U-03S	—
		R1/8	KFH08N-01S	KFH08B-01S
ø6	ø6	R1/4	KFH08N-02S	KFH08B-02S
		R3/8	KFH08N-03S	KFH08B-03S
		R1/4	KFH10U-02S	—
ø10	ø6.5	R3/8	KFH10U-03S	—
		R1/2	KFH10U-04S	—
		R1/4	KFH10N-02S	KFH10B-02S
ø7.5	ø8	R3/8	KFH10N-03S	KFH10B-03S
		R1/2	KFH10N-04S	KFH10B-04S
		R1/4	KFH12U-02S	—
ø8	ø8	R3/8	KFH12U-03S	—
		R1/2	KFH12U-04S	—
		R1/4	KFH12N-02S	KFH12B-02S
ø12	ø9	R3/8	KFH12N-03S	KFH12B-03S
		R1/2	KFH12N-04S	KFH12B-04S



Branch Tee

Use to branch line from female thread in both 90° directions.

Applicable tubing size (mm)		Connection thread	Model	
O.D.	I.D.		Resin sleeve	Brass sleeve
ø4	ø2.5	R1/8	KFT04-01S	KFT04B-01S
		R1/4	KFT04-02S	KFT04B-02S
		R1/8	KFT06-01S	KFT06B-01S
ø6	ø4	R1/4	KFT06-02S	KFT06B-02S
		R3/8	KFT06-03S	KFT06B-03S
		R1/8	KFT08U-01S	—
ø8	ø5	R1/4	KFT08U-02S	—
		R3/8	KFT08U-03S	—
		R1/8	KFT08N-01S	KFT08B-01S
ø6	ø6	R1/4	KFT08N-02S	KFT08B-02S
		R3/8	KFT08N-03S	KFT08B-03S
		R1/4	KFT10U-02S	—
ø10	ø6.5	R3/8	KFT10U-03S	—
		R1/2	KFT10U-04S	—
		R1/4	KFT10N-02S	KFT10B-02S
ø7.5	ø8	R3/8	KFT10N-03S	KFT10B-03S
		R1/2	KFT10N-04S	KFT10B-04S
		R1/4	KFT12U-02S	—
ø8	ø8	R3/8	KFT12U-03S	—
		R1/2	KFT12U-04S	—
		R1/4	KFT12N-02S	KFT12B-02S
ø12	ø9	R3/8	KFT12N-03S	KFT12B-03S
		R1/2	KFT12N-04S	KFT12B-04S

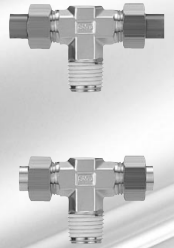

Male Elbow

Use to pipe at right angles to female thread. Most general type.

Applicable tubing size (mm)		Connection thread	Model	
O.D.	I.D.		Resin sleeve	Brass sleeve
ø4	ø2.5	R1/8	KFL04-01S	KFL04B-01S
		R1/4	KFL04-02S	KFL04B-02S
		R1/8	KFL06-01S	KFL06B-01S
ø6	ø4	R1/4	KFL06-02S	KFL06B-02S
		R3/8	KFL06-03S	KFL06B-03S
		R1/8	KFL08U-01S	—
ø8	ø5	R1/4	KFL08U-02S	—
		R3/8	KFL08U-03S	—
		R1/8	KFL08N-01S	KFL08B-01S
ø6	ø6	R1/4	KFL08N-02S	KFL08B-02S
		R3/8	KFL08N-03S	KFL08B-03S
		R1/4	KFL10U-02S	—
ø10	ø6.5	R3/8	KFL10U-03S	—
		R1/2	KFL10U-04S	—
		R1/4	KFL10N-02S	KFL10B-02S
ø7.5	ø8	R3/8	KFL10N-03S	KFL10B-03S
		R1/2	KFL10N-04S	KFL10B-04S
		R1/4	KFL12U-02S	—
ø8	ø8	R3/8	KFL12U-03S	—
		R1/2	KFL12U-04S	—
		R1/4	KFL12N-02S	KFL12B-02S
ø12	ø9	R3/8	KFL12N-03S	KFL12B-03S
		R1/2	KFL12N-04S	KFL12B-04S



Male Run Tee

Use to branch line in the same direction from female thread and in 90° direction.

Applicable tubing size (mm)		Connection thread	Model	
O.D.	I.D.		Resin sleeve	Brass sleeve
ø4	ø2.5	R1/8	KFY04-01S	KFY04B-01S
		R1/4	KFY04-02S	KFY04B-02S
		R1/8	KFY06-01S	KFY06B-01S
ø6	ø4	R1/4	KFY06-02S	KFY06B-02S
		R3/8	KFY06-03S	KFY06B-03S
		R1/8	KFY08U-01S	—
ø8	ø5	R1/4	KFY08U-02S	—
		R3/8	KFY08U-03S	—
		R1/8	KFY08N-01S	KFY08B-01S
ø6	ø6	R1/4	KFY08N-02S	KFY08B-02S
		R3/8	KFY08N-03S	KFY08B-03S
		R1/4	KFY10U-02S	—
ø10	ø6.5	R3/8	KFY10U-03S	—
		R1/2	KFY10U-04S	—
		R1/4	KFY10N-02S	KFY10B-02S
ø7.5	ø8	R3/8	KFY10N-03S	KFY10B-03S
		R1/2	KFY10N-04S	KFY10B-04S
		R1/4	KFY12U-02S	—
ø8	ø8	R3/8	KFY12U-03S	—
		R1/2	KFY12U-04S	—
		R1/4	KFY12N-02S	KFY12B-02S
ø12	ø9	R3/8	KFY12N-03S	KFY12B-03S
		R1/2	KFY12N-04S	KFY12B-04S



Female Union

Use to pipe from male thread such as pressure gauge.

Applicable tubing size (mm)		Connection thread	Model	
O.D.	I.D.		Resin sleeve	Brass sleeve
ø4	ø2.5	R1/4	KFF04-02	KFF04B-02
		R1/4	KFF06-02	KFF06B-02
ø6	ø4	R3/8	KFF06-03	KFF06B-03
		R1/4	KFF08U-02	—
ø8	ø6	R1/4	KFF08N-02	KFF08B-02
		R1/4	KFF10U-02	—
ø10	ø7.5	R1/4	KFF10N-02	KFF10B-02
		R1/4	KFF12U-02	—
ø12	ø9	R1/4	KFF12N-02	KFF12B-02



Bulkhead Connector

Use to connect male thread and tube through a panel.

Applicable tubing size (mm)		Connection thread	Model	
O.D.	I.D.		Resin sleeve	Brass sleeve
ø6	ø4	R1/4	KFE06-02	KFE06B-02
		R3/8	KFE08U-03	—
ø8	ø6	R3/8	KFE08N-03	KFE08B-03
		R3/8	KFE10U-03	—
ø10	ø7.5	R3/8	KFE10N-03	KFE10B-03
		R3/8	KFE12U-03	—
ø12	ø9	R3/8	KFE12N-03	KFE12B-03

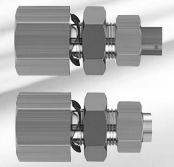

Swivel Elbow

Use to pipe at right angles to female thread. Swiveled at any direction.

Applicable tubing size (mm)		Connec-tion thread	Model	
O.D.	I.D.		Resin sleeve	Brass sleeve
ø4	ø2.5	R1/8	KFV04-01S	KFV04B-01S
		R1/4	KFV04-02S	KFV04B-02S
ø6	ø4	R1/8	KFV06-01S	KFV06B-01S
		R1/4	KFV06-02S	KFV06B-02S
		R3/8	KFV06-03S	KFV06B-03S
ø8	ø5	R1/8	KFV08U-01S	—
		R1/4	KFV08U-02S	—
		R3/8	KFV08U-03S	—
ø6	ø6	R1/8	KFV08B-01S	KFV08B-01S
		R1/4	KFV08B-02S	KFV08B-02S
		R3/8	KFV08B-03S	KFV08B-03S
ø10	ø6.5	R1/4	KFV10U-02S	—
		R3/8	KFV10U-03S	—
		R1/2	KFV10U-04S	—
ø7.5	ø7.5	R1/4	KFV10N-02S	KFV10B-02S
		R3/8	KFV10N-03S	KFV10B-03S
		R1/2	KFV10N-04S	KFV10B-04S
ø8	ø8	R1/4	KFV12U-02S	—
		R3/8	KFV12U-03S	—
		R1/2	KFV12U-04S	—
ø12	ø9	R1/4	KFV12N-02S	KFV12B-02S
		R3/8	KFV12N-03S	KFV12B-03S
		R1/2	KFV12N-04S	KFV12B-04S



Swivel Long Elbow

Use to pipe at right angles to female thread. Swiveled at any direction. Solid piece moves fittings up from workpiece.

Applicable tubing size (mm)		Connec-tion thread	Model	
O.D.	I.D.		Resin sleeve	Brass sleeve
ø4	ø2.5	R1/8	KFW04-01S	KFW04B-01S
		R1/4	KFW04-02S	KFW04B-02S
ø6	ø4	R1/8	KFW06-01S	KFW06B-01S
		R1/4	KFW06-02S	KFW06B-02S
		R3/8	KFW06-03S	KFW06B-03S
ø8	ø5	R1/8	KFW08U-01S	—
		R1/4	KFW08U-02S	—
		R3/8	KFW08U-03S	—
ø6	ø6	R1/8	KFW08B-01S	KFW08B-01S
		R1/4	KFW08B-02S	KFW08B-02S
		R3/8	KFW08B-03S	KFW08B-03S
ø10	ø6.5	R1/4	KFW10U-02S	—
		R3/8	KFW10U-03S	—
		R1/2	KFW10U-04S	—
ø7.5	ø7.5	R1/4	KFW10N-02S	KFW10B-02S
		R3/8	KFW10N-03S	KFW10B-03S
		R1/2	KFW10N-04S	KFW10B-04S
ø8	ø8	R1/4	KFW12U-02S	—
		R3/8	KFW12U-03S	—
		R1/2	KFW12U-04S	—
ø12	ø9	R1/4	KFW12N-02S	KFW12B-02S
		R3/8	KFW12N-03S	KFW12B-03S
		R1/2	KFW12N-04S	KFW12B-04S



Straight Union

Use to connect tubes in the same direction.

Applicable tubing size (mm)		Model	
O.D.	I.D.	Resin sleeve	Brass sleeve
ø4	ø2.5	KFH04-00	KFH04B-00
		KFH06-00	KFH06B-00
ø6	ø4	KFH08U-00	—
		KFH08N-00	KFH08B-00
ø8	ø6	KFH10U-00	—
		KFH10N-00	KFH10B-00
ø10	ø7.5	KFH12U-00	—
		KFH12N-00	KFH12B-00

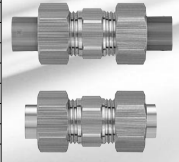

Tee Union

Use to connect tubes in both 90° directions.

Applicable tubing size (mm)		Model	
O.D.	I.D.	Resin sleeve	Brass sleeve
ø4	ø2.5	KFT04-00	KFT04B-00
		KFT06-00	KFT06B-00
ø6	ø4	KFT08U-00	—
		KFT08N-00	KFT08B-00
ø8	ø6	KFT10U-00	—
		KFT10N-00	KFT10B-00
ø10	ø7.5	KFT12U-00	—
		KFT12N-00	KFT12B-00

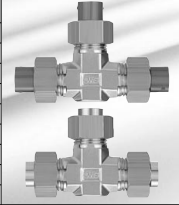

Bulkhead Union

Use to connect tubes through a panel.

Applicable tubing size (mm)		Model	
O.D.	I.D.	Resin sleeve	Brass sleeve
ø4	ø2.5	KFE04-00	KFE04B-00
		KFE06-00	KFE06B-00
ø6	ø4	KFE08U-00	—
		KFE08N-00	KFE08B-00
ø10	ø6.5	KFE10U-00	—
		KFE10N-00	KFE10B-00
ø12	ø8	KFE12U-00	—
		KFE12N-00	KFE12B-00

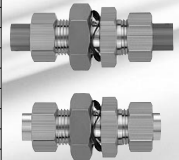

Plug

Use to plug unused fittings.

Applicable tubing size (mm)		Model
ø4		KFP-04
ø6		KFP-06
ø8		KFP-08
ø10		KFP-10
ø12		KFP-12



Insert Fittings

KF Series



Resin sleeve



Brass sleeve

Specifications

Sleeve material	Resin	Brass
Fluid	Air, Water, Turbine oil class 1 (ISO VG32) ^{Note 2)} ^{Note 3)}	Air, Steam, Turbine oil class 1 (ISO VG32) ^{Note 2)} ^{Note 3)}
Ambient and fluid temperature	-5 to 60°C (No freezing) ^{Note 4)} Water: 0 to 60°C (No freezing)	-5 to 150°C (No freezing) ^{Note 4)}
Operating pressure range ^{Note 1)}	-101.3 kPa to 1 MPa ^{Note 4)}	
Proof pressure	7.0 MPa (at 60°C)	
Lubricant	Grease-free	
Seal on the threads	None or with sealant	

Note 1) Do not use the fittings with a leak tester or for vacuum retention because they are not guaranteed for zero leakage.
 Note 2) Swivel type is not compatible with water, steam and turbine oil class 1 (ISO VG32).
 Note 3) Consult with SMC regarding applicable tube separately.
 Note 4) Check the operating pressure range and operating temperature range of the tubing.

Applicable Tubing

Series	Tubing O.D.	Tubing O.D. x I.D. (mm)							
		ø4 x ø2.5	ø6 x ø4	ø8 x ø5	ø8 x ø6	ø10 x ø6.5	ø10 x ø7.5	ø12 x ø8	ø12 x ø9
T	Nylon	●	●	—	●	—	●	—	●
TS	Soft nylon	●	●	—	●	—	●	—	●
TU	Polyurethane	●	●	●	—	●	—	●	—
TPH	Polyolefin	●	●	—	●	—	●	—	●
TPS	Soft polyolefin	●	●	●	—	●	—	●	—
TH	FEP	●	●	—	●	—	●	—	●
TL	Super PFA	—	●	—	●	—	—	—	—
TD	Modified PTFE	●	●	—	●	—	●	—	●
TUS	Soft polyurethane	●	●	●	—	●	—	●	—
TUH	Hard polyurethane (High pressure)	●	●	●	—	●	—	●	—

How to Order

KF H 06 — **01 S** —

Type

H	Male connector Straight union
L	Male elbow
T	Branch tee Tee union
F	Female union
E	Bulkhead connector Bulkhead union
Y	Male run tee
V	Swivel elbow
W	Swivel long elbow

Applicable tubing O.D.

04	ø4
06	ø6
08	ø8
10	ø10
12	ø12

Made to Order
Refer to page 179 for details.

Bore size/
Applicable tubing O.D.

Thread connection	01	R1/8
	02	R1/4, Rc1/4
	03	R3/8, Rc3/8
	04	R1/2, Rc1/2
Tubing connection	00	Same tube size

Sealant (Male thread)

Nil	None
S	With sealant

Applicable tubing / Sleeve material

Applicable tubing material	Sleeve material	Tubing size (O.D. x I.D.)							
		ø4 x ø2.5	ø6 x ø4	ø8 x ø5	ø8 x ø6	ø10 x ø6.5	ø10 x ø7.5	ø12 x ø8	ø12 x ø9
Nylon	Resin	Nil	—	N	—	N	—	N	—
	Brass	B	—	B	—	B	—	B	—
Soft nylon	Resin	Nil	—	N	—	N	—	N	—
	Brass	B	—	B	—	B	—	B	—
Polyurethane	Resin	Nil	U	—	U	—	U	—	—
	Brass	Nil	—	N	—	N	—	N	—
Polyolefin	Resin	B	—	B	—	B	—	B	—
	Brass	B	—	B	—	B	—	B	—
Soft polyolefin	Resin	Nil	U	—	U	—	U	—	—
	Brass	Nil	—	N	—	N	—	N	—
FEP	Resin	Nil	—	B	—	B	—	B	—
	Brass	B	—	B	—	B	—	B	—
Super PFA	Resin	—	Nil	—	N	—	—	—	—
	Brass	—	B	—	B	—	—	—	—
Modified PTFE	Resin	Nil	—	N	—	N	—	N	—
	Brass	B	—	B	—	B	—	B	—
Soft polyurethane	Resin	Nil	U	—	U	—	U	—	—
	Hard polyurethane (High pressure)	Resin	Nil	U	—	U	—	U	—

For details on applicable tubing O.D. and port size combinations for each model, refer to the charts on the Dimensions page.

Construction

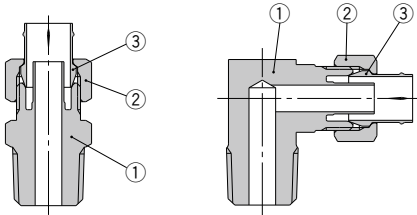

Principal Parts Material

No	Part no.	Material
1	Body	C3604, C3771
2	Union nut	C3604
3	Resin sleeve, plug	Nylon 66
	Brass sleeve	C2700

Identification of Fitting Body Exterior by Applicable Tubing

- Fittings used with polyurethane tube and soft polyolefin tube (Tube O.D. $\phi 8$, $\phi 10$ and $\phi 12$) are identified by the following marks on the body.
- Union nut and sleeve are compatible.

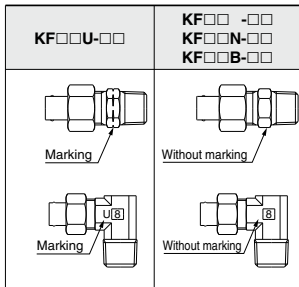

Swivel Type / Part No.

Swivel type fitting parts lineup

The bodies of elbow connectors and extended elbow connectors are compatible with almost any fitting. (Exceptions are "KFV-04" and "KFW-04" which are for the body of a $\phi 6$ tube.) Swivel fittings, elbow (KFV) and (KFW) constitute the combination with a male connector (KFH) and connector as shown in the diagram.

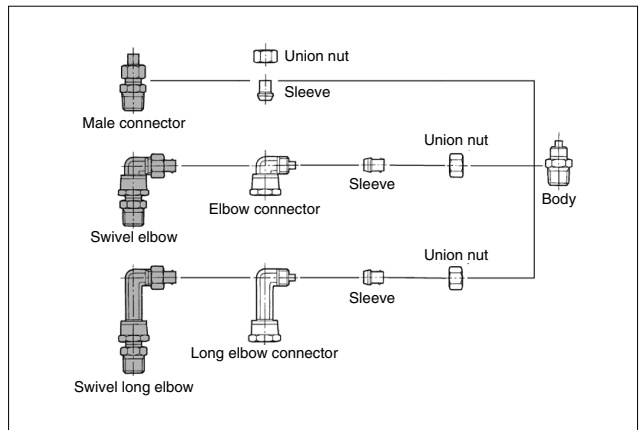

Made to Order

Symbol	Specifications
X2	Copper-free (Electroless nickel plated)

Suffix "X2" to the end of part number.
Ex.) KFH06-01S-X2

Elbow Connector: KFV

Part no.	Applicable tubing O.D./I.D.
KFV-04	$\phi 4/\phi 2.5$
KFV-06	$\phi 6/\phi 4$
KFV-08U	$\phi 8/\phi 5$
KFV-08N	$\phi 8/\phi 6$
KFV-10U	$\phi 10/\phi 6.5$
KFV-10N	$\phi 10/\phi 7.5$
KFV-12U	$\phi 12/\phi 8$
KFV-12N	$\phi 12/\phi 9$

Union Nut: KFN

Part no.	Applicable tubing O.D.
KFN-04	$\phi 4$
KFN-06	$\phi 6$
KFN-08	$\phi 8$
KFN-10	$\phi 10$
KFN-12	$\phi 12$

Long Elbow Connector: KFW

Part no.	Applicable tubing O.D./I.D.
KFW-04	$\phi 4/\phi 2.5$
KFW-06	$\phi 6/\phi 4$
KFW-08U	$\phi 8/\phi 5$
KFW-08N	$\phi 8/\phi 6$
KFW-10U	$\phi 10/\phi 6.5$
KFW-10N	$\phi 10/\phi 7.5$
KFW-12U	$\phi 12/\phi 8$
KFW-12N	$\phi 12/\phi 9$

Sleeve: KFS

Part no.		Applicable tubing O.D.
Resin sleeve	Brass sleeve	
KFS-04	KFSB-04	$\phi 4$
KFS-06	KFSB-06	$\phi 6$
KFS-08	KFSB-08	$\phi 8$
KFS-10	KFSB-10	$\phi 10$
KFS-12	KFSB-12	$\phi 12$

KF Series

Dimensions

Male Connector: KFH

Applicable tubing size (mm)		Conne- tion thread	Model	Width across flats		L ₁	L ₂	M	ød	A*	Effective area (mm ²)	Weight (g)		
O.D.	I.D.			H ₁	H ₂									
ø4	ø2.5	R1/8	KFH04-01S	10		29.6	22.9	15.5	1.5	1.6	13			
		R1/4	KFH04-02S	14		34	27.3							
		R1/8	KFH04B-01S	10	10	26.5	23.5	12.4	1.5	1.6	14			
		R1/4	KFH04B-02S	14		30.9	27.9							
ø6	ø4	R1/8	KFH06-01S	10		29.3	22.6	15.2	3	6	14			
		R1/4	KFH06-02S	14		33.7	27							
		R3/8	KFH06-03S	17	12	34.1	27.4	12.2	3	6	15			
		R1/8	KFH06B-01S	10		26.3	23.3							
		R1/4	KFH06B-02S	14		30.7	27.7	12.2	3	6	15			
		R3/8	KFH06B-03S	17		31.1	28.1							
ø8	ø5	R1/8	KFH08U-01S	12		29.3	22.6	16.2	4	11	16			
		R1/4	KFH08U-02S	14		33.7	27							
		R3/8	KFH08U-03S	17		34.1	27.4							
	ø6	ø5	R1/8	KFH08N-01S	12		29.3	22.6	16.2	5	17	16		
			R1/4	KFH08N-02S	14	14	33.7	27						
			R3/8	KFH08N-03S	17		34.1	27.4						
		ø6	ø5	R1/8	KFH08B-01S	12		26.4	23.4	13.3	5	17	17	
				R1/4	KFH08B-02S	14		30.8	27.8					
				R3/8	KFH08B-03S	17		31.2	28.2					
			ø10	ø6.5	R1/4	KFH10U-02S	17		35.3	28	18.8	5.5	21	32
					R3/8	KFH10U-03S	17		35.7	28.4				
					R1/2	KFH10U-04S	22		38.9	31.6				
ø7.5	ø6.5	R1/4		KFH10N-02S	17		35.3	28	18.8	6.5	30	31		
		R3/8		KFH10N-03S	17	17	35.7	28.4						
		R1/2		KFH10N-04S	22		38.9	31.6						
	ø7.5	ø6.5		R1/4	KFH10B-02S	17		31.5	28.5	15.0	6.5	30	33	
				R3/8	KFH10B-03S	17		31.9	28.9					
				R1/2	KFH10B-04S	22		35.1	32.1					
		ø12		ø8	R1/4	KFH12U-02S	17		35.8	29	19.3	7	35	33
					R3/8	KFH12U-03S	17		36.2	29.4				
					R1/2	KFH12U-04S	22		39.4	32.6				
ø9	ø8		R1/4	KFH12N-02S	17		35.8	29	19.3	8	45	31		
			R3/8	KFH12N-03S	17	19	36.2	29.4						
			R1/2	KFH12N-04S	22		39.4	32.6						
	ø9		ø8	R1/4	KFH12B-02S	17		32.1	29.1	15.5	8	45	33	
				R3/8	KFH12B-03S	17		32.5	29.5					
				R1/2	KFH12B-04S	22		35.7	32.6					

* Reference dimensions after installation of R thread.



Resin sleeve



Brass sleeve

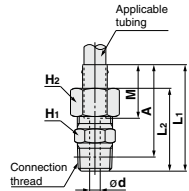

Dimensions

Male Elbow: KFL

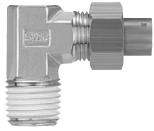

Resin sleeve



Brass sleeve

Applicable tubing size (mm)		Conne- tion thread	Model	Width across flats		L ₁	L ₂	L ₃	L ₄	M	ød	A*	Effective area (mm ²)	Weight (g)					
O.D.	I.D.			H ₁	H ₂														
ø4	ø2.5	R1/8	KFL04-01S	10	10	27.5	20.8	17	13	15.5	1.5	19.3	1.6	21					
		R1/4	KFL04-02S					19						25					
		R1/8	KFL04B-01S					17						22					
		R1/4	KFL04B-02S					19						26					
ø6	ø4	R1/8	KFL06-01S	10	12	27.2	20.5	17	13	15.2	3	19.3	6.0	22					
		R1/4	KFL06-02S					19						27					
		R3/8	KFL06-03S	12	30.2	23.5	20	13.7	21	38									
		R1/8	KFL06B-01S	10	12	24.2	21.2	17	13	12.2	19.3	23							
		R1/4	KFL06B-02S					19					28						
		R3/8	KFL06B-03S	12	27.2	24.2	20	13.7	21	39									
ø8	ø5	R1/8	KFL08U-01S	12	14	28.2	21.5	18	14	16.2	4	21.3	9.5	30					
		R1/4	KFL08U-02S					21						32					
		R3/8	KFL08U-03S					30.2						23.5	20	13.7	21	31	
		R1/8	KFL08N-01S					18						14	21.3	12	39		
	R1/4	KFL08N-02S	21	15	22.3	16	32												
	R3/8	KFL08N-03S	30.2	23.5	20	13.7	21	37											
	R1/8	KFL08B-01S	12	14	25.3	22.3	18	14	13.3	21.3	12	32							
	R1/4	KFL08B-02S					21						33						
R3/8	KFL08B-03S	27.3	24.3	20	13.7	21	38												
ø10	ø6.5	R1/4	KFL10U-02S	12	17	31.8	24.5	22	16	18.8	5.5	22.0	18	38					
		R3/8	KFL10U-03S					21						44					
		R1/2	KFL10U-04S					14						33.8	26.5	25	16.8	25.3	66
		R1/4	KFL10N-02S					22						16	23.3	23	38		
	R3/8	KFL10N-03S	12	31.8	24.5	21	14.7	22	43										
	R1/2	KFL10N-04S	14	33.8	26.5	25	16.8	25.3	65										
	R1/4	KFL10B-02S	12	17	28.0	25.0	22	16	15.0	23.3	23	39							
	R3/8	KFL10B-03S					21						44						
R1/2	KFL10B-04S	14	30.0	27.0	25	16.8	25.3	66											
ø12	ø8	R1/4	KFL12U-02S	14	19	34.3	27.5	23	17	19.3	7	24.2	30	53					
		R3/8	KFL12U-03S					22						53					
		R1/2	KFL12U-04S					25						68					
		R1/4	KFL12N-02S					23						17	25.5	27	51		
	R3/8	KFL12N-03S	22	15.7	24.2	35	52												
	R1/2	KFL12N-04S	25	16.8	25.3	67													
	R1/4	KFL12B-02S	14	19	30.6	27.6	23	17	15.5	24.2	35	54							
	R3/8	KFL12B-03S					22						57						
R1/2	KFL12B-04S	25	69																

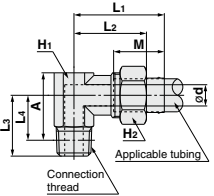

* Reference dimensions after installation of R thread.

- KQ2
- KQB2
- KS
- KX
- KM
- KF**
- M
- H/DL
- L/LL
- KC
- KK
- KK130
- DM
- KDM
- KB
- KR
- KA
- KQG2
- KG
- KFG2
- MS
- KKA
- KP
- LQ
- MQR
- T
- IDK

KF Series

Dimensions

Straight Union: KFH



Resin sleeve



Brass sleeve

Applicable tubing size (mm)		Model	Width across flats		L ₁	L ₂	M	ød	Effective area (mm ²)	Weight (g)
O.D.	I.D.		H ₁	H ₂						
ø4	ø2.5	KFH04-00	8	10	40.9	27.6	15.5	1.5	1.6	13
		KFH04B-00			34.7	28.8	12.4			14
ø6	ø4	KFH06-00	10	12	40.3	27	15.2	3	6	17
		KFH06B-00			34.3	28.4	12.2			19
ø8	ø5	KFH08U-00	12	14	41.3	28	16.2	4	11	23
		KFH08N-00			35.5	29.6	13			22
ø8	ø6	KFH08N-00	12	14	41.3	28	16.2	5	17	22
		KFH08B-00			35.5	29.6	13			24
ø10	ø6.5	KFH10U-00	17	17	44.6	30	18.8	5.5	21	36
		KFH10N-00			37.0	31.0	15.0			39
ø10	ø7.5	KFH10N-00	17	17	44.6	30	18.8	6.5	30	36
		KFH10B-00			37.0	31.0	15.0			39
ø12	ø8	KFH12U-00	17	19	45.5	32	19.3	7	35	42
		KFH12N-00			38.1	32.2	15.5			41
ø12	ø9	KFH12N-00	17	19	45.5	32	19.3	8	45	41
		KFH12B-00			38.1	32.2	15.5			44

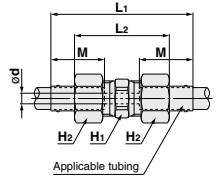

Tee Union: KFT



Resin sleeve



Brass sleeve

Applicable tubing size (mm)		Model	Width across flats		L ₁	L ₂	M	ød	Effective area (mm ²)	Weight (g)
O.D.	I.D.		H ₁	H ₂						
ø4	ø2.5	KFT04-00	10	10	27.5	20.8	15.5	1.5	1.6	33
		KFT04B-00			24.4	21.4	12.4			35
ø6	ø4	KFT06-00	10	12	27.2	20.5	15.2	3	6	37
		KFT06B-00			24.2	21.2	12.2			39
ø8	ø5	KFT08U-00	12	14	30.2	23.5	16.2	4	11	54
		KFT08N-00			27.3	24.3	13.3			53
ø8	ø6	KFT08N-00	12	14	30.2	23.5	16.2	5	17	53
		KFT08B-00			27.3	24.3	13.3			56
ø10	ø6.5	KFT10U-00	12	17	31.8	24.5	18.8	5.5	21	65
		KFT10N-00			28.0	25.0	15.0			63
ø10	ø7.5	KFT10N-00	12	17	31.8	24.5	18.8	6.5	30	63
		KFT10B-00			28.0	25.0	15.0			67
ø12	ø8	KFT12U-00	14	19	34.3	27.5	19.3	7	35	89
		KFT12N-00			30.6	27.6	15.5			85
ø12	ø9	KFT12N-00	14	19	34.3	27.5	19.3	8	45	85
		KFT12B-00			30.6	27.6	15.5			90

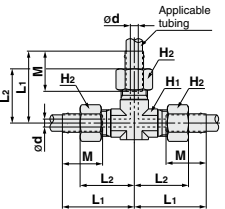

Dimensions

Branch Tee: KFT



Resin sleeve



Brass sleeve

Applicable tubing size (mm)		Connection thread R	Model	Width across flats		L ₁	L ₂	L ₃	L ₄	M	ød	A*	Effective area (mm ²)	Weight (g)			
O.D.	I.D.			H ₁	H ₂												
ø4	ø2.5	R1/8	KFT04-01S	10	10	27.5	20.8	17	13	15.5	1.5	19.3	3	29			
		R1/4	KFT04-02S					19						34			
		R1/8	KFT04B-01S					17						30			
		R1/4	KFT04B-02S					19						35			
ø6	ø4	R1/8	KFT06-01S	10	10	27.2	20.5	17	13	15.2	3	19.3	10	32			
		R1/4	KFT06-02S					19						37			
		R3/8	KFT06-03S	12	12	30.2	23.5	22	15.7	3	19.3	10	34				
		R1/4	KFT06B-02S	10	10	24.2	21.2	19	13					12.2	19.3	10	39
		R3/8	KFT06B-03S	12	12	27.2	24.2	22	15.7	3	19.3	10	39				
		R1/8	KFT08U-01S	12	14	30.2	23.5	20	16					16.2	23.3	16	46
R1/4	KFT08U-02S	23	17					23	19								
R3/8	KFT08U-03S	22	15.7							23	56						
R1/8	KFT08N-01S	20	16					23	25								
R1/4	KFT08N-02S	23	17							23	49						
R3/8	KFT08N-03S	22	15.7					5	54								
R1/8	KFT08B-01S	20	16	23.3	16	48											
R1/4	KFT08B-02S	27.3	24.3				23	17	13.3	24.3	25	51					
R3/8	KFT08B-03S	22	15.7	23	56												
ø10	ø6.5	R1/4	KFT10U-02S			12	12	31.8	24.5	22	15.7	18.8	5.5	24.3	27	46	
		R3/8	KFT10U-03S	23	17					23						34	
		R1/2	KFT10U-04S	14	14												27.3
		R1/4	KFT10N-02S	12	17					23						57	
	R3/8	KFT10N-03S	12	17	23	62											
	R1/2	KFT10N-04S	14	14			6.5	41	88								
	R1/4	KFT10B-02S	12	17	23	60											
	R3/8	KFT10B-03S	12	17			28.0	25.0	22	15.7	15.0	23	30	65			
R1/2	KFT10B-04S	14	14	30.0	27.0	27									18.8	27.3	41
ø12	ø8	R1/4	KFT12U-02S	14	19	34.3	27.5	25	19	19.3	7	26.2	44	81			
		R3/8	KFT12U-03S					24						17.7	27.3	94	
		R1/2	KFT12U-04S					27						18.8			27.5
		R1/4	KFT12N-02S					25						19	26.2	48	
	R3/8	KFT12N-03S	24	17.7	27.3	93											
	R1/2	KFT12N-04S	27	18.8			8	27.5	32	78							
	R1/4	KFT12B-02S	14	19	30.6	27.6					24	17.7	15.5	26.2	48	81	
	R3/8	KFT12B-03S	25	19			27	18.8	27.3	48							96
R1/2	KFT12B-04S	14	19														

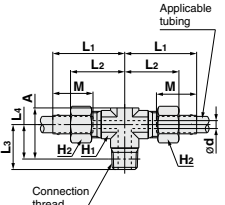

* Reference dimensions after installation of R thread.

- KQ2
- KQB2
- KS
- KX
- KM
- KF**
- M
- H/DL
- L/LL
- KC
- KK
- KK130
- DM
- KDM
- KB
- KR
- KA
- KQG2
- KG
- KFG2
- MS
- KKA
- KP
- LQ
- MQR
- T
- IDK

KF Series

Dimensions

Female Union: KFF

Applicable tubing size (mm)		Connection thread Rc	Model	Width across flats			L ₁	L ₂	L ₃	M	ød	Effective area (mm ²)	Weight (g)		
				O.D.	I.D.	H ₁								H ₂	H ₃
ø4	ø2.5	Rc1/4	KFF04-02	17	10	33.5	26.8	15	15.5	1.5	1.6	25			
			KFF04B-02			30.4	27.4		12.4						
ø6	ø4	Rc3/8	KFF06-02	17	12	33.2	26.5	15	15.2	3	6	27			
			KFF06-03			35.2	28.5		17			30			
			KFF06B-02			30.2	27.2	15	28						
			KFF06B-03			32.2	29.2	17	31						
ø8	ø5	Rc1/4	KFF08U-02	17	14	33.2	26.5	15	16.2	4	11	28			
			KFF08B-02			30.3	27.3		13.3			5	17	29	
ø10	ø6.5	Rc1/4	KFF10U-02	17	17	34.8	27.5	15	18.8	5.5	21	32			
			KFF10N-02			31.0	28.0		15.0			6.5	30	33	
			KFF10B-02			31.0	28.0	15.0	6.5			30	33		
ø12	ø8	Rc1/4	KFF12U-02	17	19	35.3	28.5	15	19.3	7	35	35			
			KFF12N-02			31.6	28.6		15.5			8	45	36	
			KFF12B-02			31.6	28.6	15.5	8			45	38		

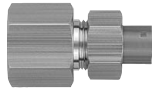

Resin sleeve

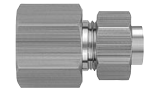

Brass sleeve

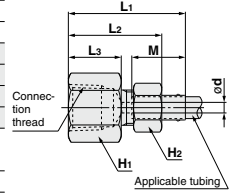

Bulkhead Connector: KFE

Applicable tubing size (mm)		Connection thread Rc	Model	Width across flats			L ₁	L ₂	L ₃	M	ød	T ₂	Mounting hole	Effective area (mm ²)	Weight (g)		
				O.D.	I.D.	H ₁										H ₂	H ₃
ø6	ø4	Rc1/4	KFE06-02	17	12	17	44.2	37.5	16	15.2	3	M10 x 1	11	6	41		
			KFE06B-02				41.2	38.2		12.2					4	11	49
ø8	ø5	Rc3/8	KFE08U-03	19	14	19	46.2	39.5	17	16.2	4	M12 x 1	13	17	50		
			KFE08N-03				43.3	40.3		13.3					5	17	51
			KFE08B-03				43.3	40.3	13.3	5					17	51	
			KFE08U-03				48.8	41.5	17	18.8					5.5	21	63
ø10	ø6.5	Rc3/8	KFE10U-03	19	17	22	45.0	42.0	17	15.0	6.5	M15 x 1	16	30	62		
			KFE10N-03				45.0	42.0		15.0					6.5	30	63
			KFE10B-03				45.0	42.0	15.0	6.5					30	63	
ø12	ø8	Rc3/8	KFE12U-03	22	19	24	51.3	44.5	17	19.3	7	M17 x 1	18	35	93		
			KFE12N-03				47.6	44.6		15.5					8	45	91
			KFE12B-03				47.6	44.6	15.5	8					45	93	

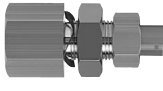

Resin sleeve

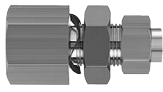

Brass sleeve

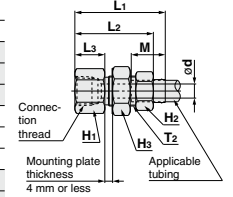

Bulkhead Union: KFE

Applicable tubing size (mm)		Model	Width across flats			L ₁	L ₂	M	ød	Mounting hole	Effective area (mm ²)	Weight (g)		
			O.D.	I.D.	H ₁								H ₂	H ₃
ø4	ø2.5	KFE04-00	12	10	13	50.9	37.6	15.5	1.5	9	1.6	23		
		KFE04B-00				44.7	38.8	12.4				24		
ø6	ø4	KFE06-00	14	12	17	51.3	38	15.2	3	11	6	34		
		KFE06B-00				45.3	39.4	12.2				36		
ø8	ø5	KFE08U-00	17	14	19	52.3	39	16.2	4	13	11	47		
		KFE08N-00				46.5	40.6	13				5	17	46
		KFE08B-00				46.5	40.6	13	5			17	48	
ø10	ø6.5	KFE10U-00	19	17	22	56.6	42	18.8	5.5	16	21	67		
		KFE10N-00				49.0	43.0	15.0				6.5	30	66
		KFE10B-00				49.0	43.0	15.0	6.5			30	69	
ø12	ø8	KFE12U-00	22	19	24	59.5	46	19.3	7	18	35	87		
		KFE12N-00				52.1	46.2	15.5				8	45	85
		KFE12B-00				52.1	46.2	15.5	8			45	88	



Resin sleeve

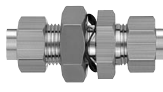

Brass sleeve

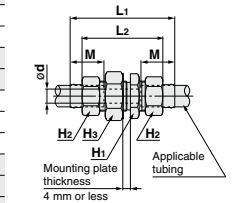

Dimensions

Male Run Tee: KFY



Resin sleeve



Brass sleeve

Applicable tubing size (mm)		Conne- tion thread R	Model	With across flats		L ₁	L ₂	L ₃	L ₄ *	M	ød	A*	Effective area (mm ²)	Weight (g)					
O.D.	I.D.			H ₁	H ₂														
ø4	ø2.5		R1/8	10	10	27.5	20.8	17	13	15.5	1.5	40.5	3.5	28					
			R1/4											KFY04-02S	32				
			R1/8	KFY04B-01S	12.4	24.4	21.4	17	19	37.4	29								
			R1/4	KFY04B-02S							33								
ø6	ø4		R1/8	10	12	27.2	20.5	19	13	15.2	3	40.2	11	31					
			R1/4											KFY06-02S	37				
			R3/8	KFY06-03S	12	30.2	23.5	22	15.7	46.8	13	51							
			R1/8	KFY06B-01S								33							
			R1/4	KFY06B-02S	10	24.2	21.2	19	13	37.2	11	39							
			R3/8	KFY06B-03S								53							
ø8	ø5		R1/8	12	14	30.2	23.5	20	16	16.2	4	46.2	15	48					
			R1/4					KFY08U-02S	23					17	47.2	21	50		
			R3/8					KFY08U-03S	22					15.7	45.8	21	55		
			R1/8					KFY08N-01S	20					16	46.2	18	47		
	ø6			R1/4	12	14	27.3	24.3	23	17	13.3	5	47.2	27	48				
				R3/8					KFY08N-03S	22					15.7	45.8	27	53	
				R1/8					KFY08B-01S	20					16	43.3	18	49	
				R1/4					KFY08B-02S	23					17	44.3	27	50	
				R3/8					KFY08B-03S	22					15.7	42.9	27	55	
				R1/2					KFY08B-04S	30.0					27.0	27	18.8	48.8	46
ø10	ø6.5		R1/4	12	17	31.8	24.5	23	17	18.8	5.5	48.8	30	58					
			R3/8					KFY10U-03S	22					15.7	47.4	38	63		
			R1/2					KFY10U-04S	33.8					26.5	27	18.8	52.6	89	
			R1/4					KFY10N-02S	23					17	48.8	33	57		
	ø7.5			R3/8	12	17	31.8	24.5	22	15.7	6.5	15.0	47.4	46	62				
				R1/2					KFY10N-04S	33.8					26.5	27	18.8	52.6	88
				R1/4					KFY10B-02S	23					17	45.0	33	60	
				R3/8					KFY10B-03S	22					15.7	43.6	46	65	
R1/2	KFY10B-04S	30.0	27.0	27	18.8	48.8	46	91											
ø12	ø8		R1/4	14	19	34.3	27.5	25	19	19.3	7	53.3	34	79					
			R3/8					KFY12U-03S	24					17.7	51.9	49	79		
			R1/2					KFY12U-04S	27					18.8	53.1	93			
			R1/4					KFY12N-02S	25					19	53.3	36	76		
	ø9			R3/8	14	19	30.6	27.6	24	17.7	15.5	8	51.9	54	78				
				R1/2					KFY12N-04S	27					18.8	53.1	92		
				R1/4					KFY12B-02S	25					19	49.6	36	79	
				R3/8					KFY12B-03S	24					17.7	48.2	81		
				R1/2					KFY12B-04S	27					18.8	49.4	95		

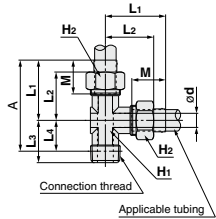

* Reference dimensions after installation of R thread.

- KQ2
- KQB2
- KS
- KX
- KM
- KF**
- M
- H/DL
- L/LL
- KC
- KK
- KK130
- DM
- KDM
- KB
- KR
- KA
- KQG2
- KG
- KFG2
- MS
- KKA
- KP
- LQ
- MQR
- T
- IDK

KF Series

Dimensions

Swivel Elbow: KVF

(mm)



Resin sleeve



Brass sleeve

Applicable tubing size (mm)		Connection thread R	Model	Width across flats				L ₁	L ₂	L ₃	L ₄ *	M	ød	A*	Effective area (mm ²)	Weight (g)	
O.D.	I.D.			H ₁	H ₂	H ₃	H ₄										
ø4	ø2.5		R1/8	KFV04-01S	10	10	14	10	19.3	32.8	29.7	15.5	35.5	1.4	5	40	
			R1/4	KFV04-02S				14								37.5	31.7
			R1/8	KFV04B-01S	10	22.9	19.9	12.4	10	32.8	29.7	35.5	41				
			R1/4	KFV04B-02S	14				37.2	31.7	37.5	51					
			R1/8	KFV06-01S	10	10	12	14	10	25.7	19	32.8	29.7			15.2	36.6
R1/4	KFV06-02S	14	37.2	31.7	36.6				52								
R3/8	KFV06-03S	17	37.6	32.4	39.3				64								
R1/8	KFV06B-01S	10	22.7	19.7	12.2				10	32.8	29.7	36.6	43				
R1/4	KFV06B-02S	14							37.2	31.7	36.6	53					
R3/8	KFV06B-03S	17				37.6	32.4	39.3	65								
ø6	ø4		R1/8	KFV08U-01S	10	12	14	12	27.2	20.5	16.2	38.8	9.4	5	52		
			R1/4	KFV08U-02S				14							38.2	32.7	41.5
			R3/8	KFV08U-03S				17	38.6	33.4	41.5	72					
			R1/8	KFV08N-01S	12	12	14	17	12	24.3	21.3	13.3	38.8	30.7	14	5	57
			R1/4	KFV08N-02S	14				38.2								32.7
			R3/8	KFV08N-03S	17				38.6	33.4	41.5	72					
			R1/8	KFV08B-01S	10	12	14	17	10	24.3	21.3	13.3	38.8	30.7	5	5	58
			R1/4	KFV08B-02S	14				38.2								32.7
			R3/8	KFV08B-03S	17				38.6	33.4	41.5	73					
ø8	ø6.5		R1/4	KFV10U-02S	14	17	19	17	28.8	21.5	18.8	5.5	45.5	18	25	73	
			R3/8	KFV10U-03S				17								40.2	34.7
			R1/2	KFV10U-04S	22	43.8	36.5	46.3	104								
			R1/4	KFV10N-02S	17	25.0	22.0	15.0	17	40.2	34.7	44.5	72				
			R3/8	KFV10N-03S	17				40.6	35.4	45.2	80					
			R1/2	KFV10N-04S	22				43.8	36.5	46.3	104					
			R1/4	KFV10B-02S	17	25.0	22.0	15.0	17	40.2	34.7	44.5	73				
			R3/8	KFV10B-03S	17				40.6	35.4	45.2	81					
			R1/2	KFV10B-04S	22				43.8	36.5	46.3	105					
			ø10	ø8		R1/4	KFV12U-02S	17	19	22	17	30.3	23.5	19.3	7	46.7	30
R3/8	KFV12U-03S	17				41.2	35.7				46.7						
R1/2	KFV12U-04S	22				44.8	37.5	48.5	124								
R1/4	KFV12N-02S	17				26.6	23.6	15.5	17	41.2	35.7	46.7	90				
R3/8	KFV12N-03S	17							41.6	36.4	47.4	98					
R1/2	KFV12N-04S	22							44.8	37.5	48.5	123					
ø9				R1/4	KFV12B-02S	17	19	22	17	26.6	23.6	15.5	8	46.7	38	48.5	92
				R3/8	KFV12B-03S				17								41.6
				R1/2	KFV12B-04S	22	44.8	37.5	48.5	125							

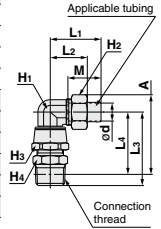

* Reference dimensions after installation of R thread.

Dimensions

Swivel Long Elbow: KFW



Resin sleeve



Brass sleeve

Applicable tubing size (mm)		Connection thread R	Model	Width across flats				L ₁	L ₂	L ₃	L ₄ *	M	ød	A*	Effective area (mm ²)	Weight (g)	
O.D.	I.D.			H ₁	H ₂	H ₃	H ₄										
ø4	ø2.5	R/8	KFW04-01S	10	10	14	10	26	19.3	52.8	49.7	15.5	55.5	1.4	58		
		R1/4	KFW04-02S				14									57.2	51.7
		R/8	KFW04B-01S	10	22.9	19.9	10	52.8	49.7	12.4	55.5	61					
		R1/4	KFW04B-02S	14			57.2						51.7				
		ø6	ø4	R/8	KFW06-01S	10	12	14	10	25.7	19.0	53.8	50.7	15.2	57.6	5.0	61
R1/4	KFW06-02S			14	58.2				52.7								
R/8	KFW06-03S			10	22.7	19.7	10	53.8	50.7	12.2	57.6	66					
R1/4	KFW06B-02S			14			58.2						52.7				
R/8	KFW06B-03S			10	27.2	20.5	10	54.8	51.7	16.2	59.8	77					
R1/4	KFW08U-02S			14			59.2						53.7				
ø8	ø6			R/8	KFW08U-03S	12	14	17	12	24.3	21.3	59.2	53.7	13.3	61.8	9.4	83
				R1/4	KFW08N-01S				14								
				R/8	KFW08N-03S	12	27.2	20.5	12	54.8	51.7	16.2	59.8	88			
		R1/4	KFW08B-01S	14	59.2	53.7											
		R/8	KFW08B-02S	12	24.3	21.3	12	59.2	53.7	13.3	61.8	82					
		R1/4	KFW08B-03S	14			59.6						54.4				
		ø10	ø6.5	R/8	KFW10U-02S	14	17	19	17	28.8	21.5	61.2	55.7	18.8	65.5	18	100
				R1/2	KFW10U-04S				22								
				R/8	KFW10N-02S	14	27.2	20.5	14	61.2	55.7	16.2	65.5	99			
R1/4	KFW10N-03S			17	61.6	56.4											
R/8	KFW10B-02S			14	25.0	22.0	14	61.6	56.4	15.0	66.2	104					
R1/4	KFW10B-03S			17			61.2						55.7				
R/8	KFW10B-04S		14	27.2	20.5	14	64.8	57.5	18.8	67.3	128						
R1/2	KFW10B-04S		22			65.5						59.9					
ø12	ø8		R/8	KFW12U-02S	17	19	22	17	30.3	23.5	64.2	58.7	19.3	69.7	30	146	
			R1/4	KFW12U-03S				22									64.6
			R/8	KFW12N-02S	17	27.2	20.5	17	64.2	58.7	16.2	69.7	144				
			R1/4	KFW12N-03S	22			64.6						59.4			
		R/8	KFW12B-02S	17	25.0	22.0	17	64.2	58.7	15.0	70.4	145					
		R1/4	KFW12B-03S	22			64.6						59.4				
	R/8	KFW12B-04S	17	26.6	23.6	17	64.2	58.7	15.5	70.4	146						
	R1/2	KFW12B-04S	22			67.8						60.5					

* Reference dimensions after installation of R thread.

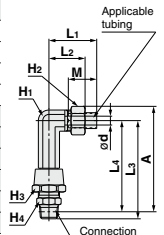

Plug: KFP



(mm)				
Applicable tubing size (mm)	Model	L ₁	ød	Weight (g)
ø4	KFP-04	12	6.5	0.3
ø6	KFP-06	12	8.5	0.5
ø8	KFP-08	12	10.4	0.7
ø10	KFP-10	13.5	13	1.0
ø12	KFP-12	14	15	1.4



- KQ2
- KQB2
- KS
- KX
- KM
- KF**
- M
- H/DL
- L/LL
- KC
- KK
- KK130
- DM
- KDM
- KB
- KR
- KA
- KQG2
- KG
- KFG2
- MS
- KKA
- KP
- LQ
- MQR
- T
- IDK

KF Series

Dimensions

Elbow Connector: KFW



Applicable tubing size (mm)		Model	Width across flats		L ₁	L ₂	ød	Weight (g)
O.D.	I.D.		H ₁	H ₂				
ø4	ø2.5	KFW-04	10	14	18.5	18.5	1.5	21.1
ø6	ø4	KFW-06	10	14	18.5	18.5	3	21.6
ø8	ø5	KFW-08U	12	17	20	19.5	4	32.8
	ø6	KFW-08N					5	32.9
ø10	ø6.5	KFW-10U	14	19	21	21.5	5.5	41.9
	ø7.5	KFW-10N					6.5	41.7
ø12	ø8	KFW-12U	17	22	22	22.5	7	61.8
	ø9	KFW-12N					8	61.6

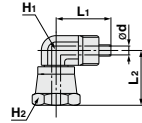

Long Elbow Connector: KFW



Applicable tubing size (mm)		Model	Width across flats		L ₁	L ₂	ød	Weight (g)
O.D.	I.D.		H ₁	H ₂				
ø4	ø2.5	KFW-04	10	14	18.5	38.5	1.5	31.7
ø6	ø4	KFW-06	10	14	18.5	39.5	3	33.0
ø8	ø5	KFW-08U	12	17	20	40.5	4	48.0
	ø6	KFW-08N					5	46.8
ø10	ø6.5	KFW-10U	14	19	21	42.5	5.5	62.4
	ø7.5	KFW-10N					6.5	63.4
ø12	ø8	KFW-12U	17	22	22	45.5	7	94.0
	ø9	KFW-12N					8	94.5

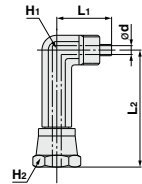

Sleeve: KFS



Resin sleeve



Brass sleeve

Applicable tubing size (mm)		Model	L	øD	Weight (g)
ø4	KFS-04				
	KFSB-04	8.7	0.6		
ø6	KFS-06	12	8.5	0.1	
	KFSB-06	8.8		0.9	
ø8	KFS-08	12	10.5	0.2	
	KFSB-08	8.8		1.2	
ø10	KFS-10	13.5	13	0.3	
	KFSB-10	9.6		1.7	
ø12	KFS-12	14	15	0.4	
	KFSB-12	10.1		2.1	



Union Nut: KFN



Applicable tubing size (mm)		Model	Width across flats		Weight (g)
			H	L	
ø4		KFN-04	10	8	3.0
ø6		KFN-06	12	8	3.8
ø8		KFN-08	14	8	4.7
ø10		KFN-10	17	9	7.0
ø12		KFN-12	19	10	9.5





KF Series

Specific Product Precautions 1

Be sure to read this before handling the products.

Refer to back page 50 for Safety Instructions and pages 13 to 17 for Fittings and Tubing Precautions.

Selection

⚠ Caution

1. Please consult with SMC regarding fluids other than air and steam.

Piping

⚠ Caution

1. Installation of tubing
 - 1) Take a tube having no flaws on its periphery and cut it off at right angles. Do not use pinchers, nippers or scissors, etc. The tubing might be cut diagonally or flattened, making installation impossible or causing problems such as disconnection and leakage.
 - 2) Without loosening the union nut, grab the tube and gently push it thoroughly into the fitting.
 - 3) After insertion, confirm that the tube will not disconnect.

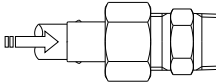

- 4) When the union is loose, tighten it additionally, temporarily by hand.
- 5) After fixing the body with the tightening tool, tighten the union nut with an appropriate wrench, applying the torque as shown below. After tightening the clearance between the union nut and the body in the axial direction is about 2 mm.

Fitting size	Sleeve material			
	Resin		Brass	
	Appropriate tightening rotations	Equivalent tightening torque (N·m)	Appropriate tightening rotations	Equivalent tightening torque (N·m)
KF□04	1.5 to 2.0	2 to 7	1.5	2 to 4
KF□06	1.5 to 2.0	3 to 8	1.5	4 to 6
KF□08	1.5 to 2.0	4 to 9	1.5	6 to 9
KF□10	1.5 to 2.0	6 to 9	1.5	10 to 12
KF□12	1.5 to 2.0	9 to 12	1.5	10 to 12

Piping

⚠ Caution

2. How to connect elbow type connector
 - 1) First tighten by hand, then use an appropriate wrench to tighten 1/6 to 1/3 turns additionally. Refer to the table below for equivalent tightening torque.

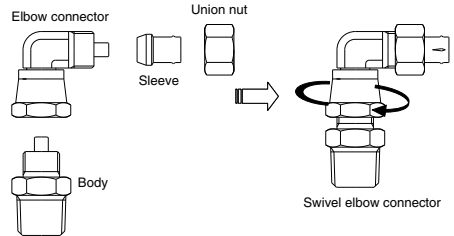

Fitting size	Appropriate tightening rotations	Equivalent tightening torque (N·m)
KF□-04	1/6 to 1/3	3 to 7
KF□-06	1/6 to 1/3	3 to 7
KF□-08	1/6 to 1/3	3 to 7
KF□-10	1/6 to 1/3	5 to 10
KF□-12	1/6 to 1/3	5 to 10

KQ2

KQB2

KS
KX

KM

KF

M

H/DL
L/LL

KC

KK

KK130

DM

KDM

KB

KR

KA

KQG2

KG

KFG2

MS

KKA

KP

LQ

MQR

T

IDK



KF Series

Specific Product Precautions 2

Be sure to read this before handling the products.

Refer to back page 50 for Safety Instructions and pages 13 to 17 for Fittings and Tubing Precautions.

Operating Environment

Warning

1. Do not use in environments or locations where there is a danger of damage to the fittings and tubing.
For fitting and tubing materials, refer to specifications and construction drawings, etc.

Maintenance

Caution

1. Pre-maintenance inspection
When the product is removed, turn off the power, cut off the supply pressure, and confirm that fluid in the piping has been discharged.
2. During regular maintenance, check for the following and replace any components as necessary.
 - a) Scratches, gouges, abrasion, corrosion
 - b) Leakage
 - c) Flattening or distortion of tubing
 - d) Hardening, deterioration or softness of tubing
3. Do not repair the fittings or patch the tubing for reuse.
4. Using this product for extended periods of time can result in leaks due to the material change. In such cases, tighten the union nut additionally.
A guide for the additional tightening is 1/6 to 1/4 turns. But in case of the brass sleeve, the limit for additional tightening is 1/2 turns.
When there is a leak even after additional tightening, replace the sleeve with new one.
5. Sleeve is not recyclable. Replace it every time piping is performed.