

# Modular F.R.L. Units

## AC Series

RoHS

### Better visibility and environmental resistance

Double layer design

The bowl is covered with a transparent bowl guard!

- The inside is visible from 360°.
- The bowl is completely protected from the environment. Safety improved

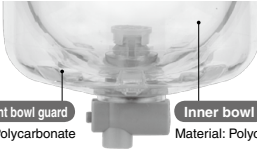

Transparent bowl guard  
Material: Polycarbonate

Inner bowl  
Material: Polycarbonate  
\* Body size: 30 or more

### Energy saving regulator

Pressure drop: Max. 50% improvement

Set pressure: 0.05 to 0.7 MPa  
0.02 to 0.2 MPa

### Easy replacement of the element

The element and the bowl are in one piece. Replacement can be done in hand.

Current model

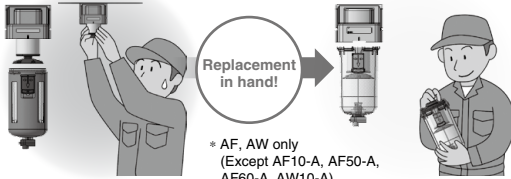

Replacement in hand!

\* AF, AW only  
(Except AF10-A, AF50-A, AF60-A, AW10-A)

### Reduced required maintenance space

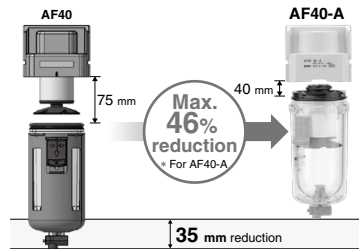

Max. 46% reduction  
\* For AF40-A

35 mm reduction

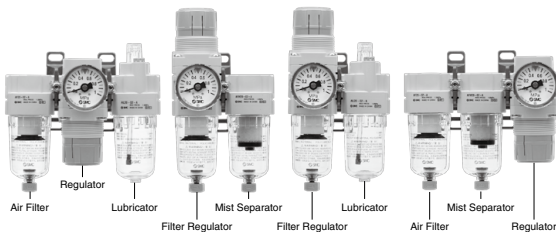

### Body size 10, 50, 60 added!

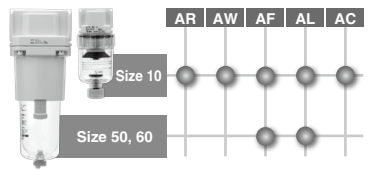

- AC-A
- AF-A
- AF□-A
- AR-A
- AL-A
- AW-A
- AC-B
- AF-A
- AF□-A
- AR-β
- AL-A
- AW-β
- AW□
- AF-G
- E□
- AV
- AF

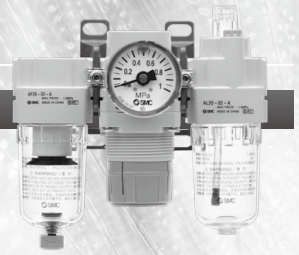

## ▶ Transparent bowl guard

**Better environmental resistance:**  
Transparent bowl guard can protect the inner bowl!

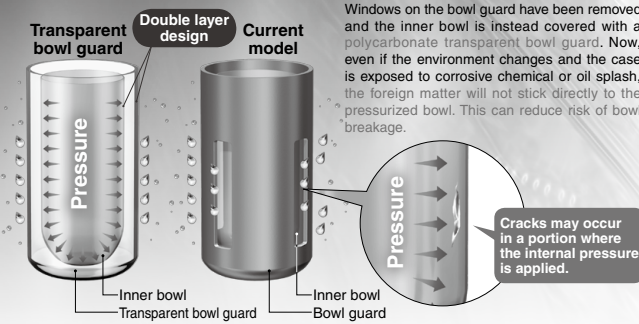

Windows on the bowl guard have been removed and the inner bowl is instead covered with a polycarbonate transparent bowl guard. Now, even if the environment changes and the case is exposed to corrosive chemical or oil splash, the foreign matter will not stick directly to the pressurized bowl. This can reduce risk of bowl breakage.

Applicable model	
Air Filter <b>AF</b>	Filter Regulator <b>AW</b>
Mist Separator <b>AFM</b>	Lubricator <b>AL</b>
Micro Mist Separator <b>AFD</b>	

\* Body size: 30 or more

## Better visibility: 360°

Use of transparent bowl guard makes it possible to check the condensate inside the filter case and the remaining oil amount in the lubricator from the entire periphery.

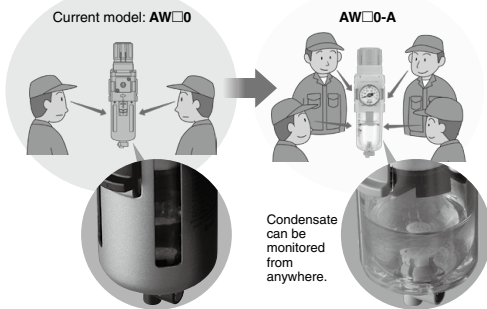

**Light weight:**  
Max. **90 g** reduction  
\* Except AW

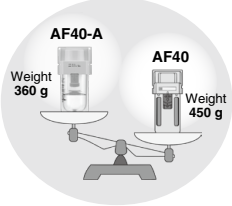

**Metal related corrosion does not occur.**

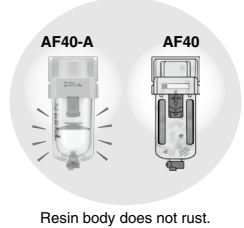

## Regulator/AR Filter Regulator/AW



**Pressure drop:**  
Max. **50%** improvement

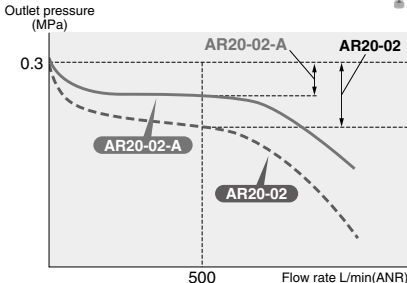

Conditions

- ◆ Inlet pressure: 0.5 MPa
- ◆ Outlet pressure: 0.3 MPa
- ◆ Flow rate: 500 L/min(ANR)

## New Spacer

### Modular connection

#### Step ①

- Mount the product by lining up the mating surface of the new spacer with bracket.
- Insert the retainer into the spacer bolt and tighten the nut. (temporary assembling)

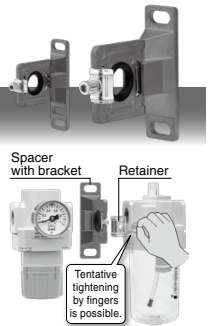

#### Step ②

- Tighten the nut with the hexagon wrench.



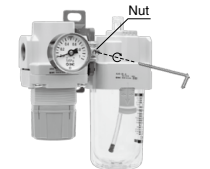

#### Interchangeable with current model

- New spacer can be connected to current AF, AR, AL, AW series.
- Current spacer cannot be used for new AR □-A, AW□-A series.

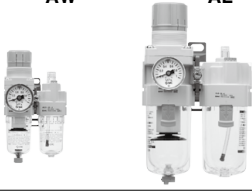

# AC Series





## Series Configuration

Product	Model	Port size							INDEX
		M5	1/8	1/4	3/8	1/2	3/4	1	
<b>Air Filter + Regulator + Lubricator</b> <b>AF AR AL</b> 	AC10-A	●							P.402
	AC20-A		●	●					
	AC25-A			●	●				
	AC30-A			●	●				
	AC40-A			●	●	●			
	AC40-06-A						●		
<b>Filter Regulator + Lubricator</b> <b>AW AL</b> 	AC10A-A	●						P.408	
	AC20A-A		●	●					
	AC30A-A			●	●				
	AC40A-A			●	●	●			
	AC40A-06-A						●		
<b>Air Filter + Regulator</b> <b>AF AR</b> 	AC10B-A	●						P.412	
	AC20B-A		●	●					
	AC25B-A			●	●				
	AC30B-A			●	●				
	AC40B-A			●	●	●			
	AC40B-06-A						●		
<b>Air Filter + Mist Separator + Regulator</b> <b>AF AFM AR</b> 	AC20C-A		●	●				P.416	
	AC25C-A			●	●				
	AC30C-A			●	●				
	AC40C-A			●	●	●			
	AC40C-06-A						●		
<b>Filter Regulator + Mist Separator</b> <b>AW AFM</b> 	AC20D-A		●	●				P.420	
	AC30D-A			●	●				
	AC40D-A			●	●	●			
	AC40D-06-A						●		



Air Combination

- AC-A
- AF-A
- AF□-A
- AR-A
- AL-A
- AW-A
- AC-B
- AF-A
- AF□-A
- AR-~~B~~
- AL-A
- AW-~~B~~
- AW□
- AF□G
- E□
- AV
- AF

## Series Configuration

Product	Model	Port size							INDEX
		M5	1/8	1/4	3/8	1/2	3/4	1	
<b>Air Filter</b> 	AF10-A	●							P.429
	AF20-A		●	●					
	AF30-A			●	●				
	AF40-A			●	●	●			
	AF40-06-A						●		
	AF50-A						●	●	
	AF60-A							●	
<b>Mist Separator</b> 	AFM20-A		●	●				P.429	
	AFM30-A			●	●				
	AFM40-A			●	●	●			
	AFM40-06-A						●		
<b>Micro Mist Separator</b> 	AFD20-A		●	●				P.429	
	AFD30-A			●	●				
	AFD40-A			●	●	●			
	AFD40-06-A						●		
<b>Regulator</b> 	AR10-A	●						P.449	
	AR20-A		●	●					
	AR25-A			●	●				
	AR30-A			●	●				
	AR40-A			●	●	●			
	AR40-06-A						●		



	Product	Model	Port size							INDEX
			M5	1/8	1/4	3/8	1/2	3/4	1	
Lubricator	<b>AL</b> 	AL10-A	●							P.459
		AL20-A		●	●					
		AL30-A			●	●				
		AL40-A			●	●	●			
		AL40-06-A						●		
		AL50-A						●	●	
		AL60-A							●	
Filter Regulator	<b>AW</b> 	AW10-A	●						P.467	
		AW20-A		●	●					
		AW30-A			●	●				
		AW40-A			●	●	●			
		AW40-06-A						●		

- AC-A
- AF-A
- AF□-A
- AR-A
- AL-A
- AW-A
- AC-B
- AF-A
- AF□-A
- AR-A
- AL-A
- AW-A
- AW□
- AC-G
- E□
- AV
- AF

## Simple Specials System

A system designed to respond quickly and easily to your special ordering needs



### Short lead times

This system enables us to respond to your special needs, such as additional machining, accessory assembly, or modular unit, and deliver such special products as quickly as standard products.

### Repeat orders

Once we receive a Simple Special part number from your previous order, we will process the order, manufacture the product, and deliver it to you.



Please contact your local sales representative for more details.

## Attachment List

### Check valve

Page 423

■ A check valve with intermediate branch port can be easily installed to prevent a backflow of lubricant when branching the air flow and releasing the air on the outlet side of the regulator.

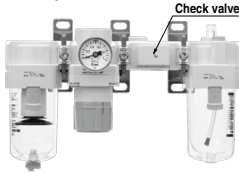

Applicable series

- Air Filter + Regulator + Lubricator (AC20-A to AC40-A)
- Filter Regulator + Lubricator (AC20A-A to AC40A-A)
- \* Port size: Except 06

### Pressure switch

Page 424

■ A compact integrated pressure switch can be easily installed and facilitates the pressure detection of the line.

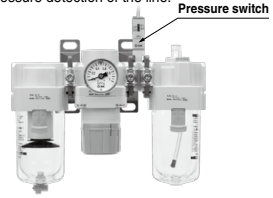

Applicable series

- Air Filter + Regulator + Lubricator (AC20-A to AC40-A)
- Filter Regulator + Lubricator (AC20A-A to AC40A-A)
- Air Filter + Regulator (AC20B-A to AC40B-A)
- Air Filter + Mist Separator + Regulator (AC20C-A to AC40C-A)
- Filter Regulator + Mist Separator (AC20D-A to AC40D-A)

### T-spacer

Page 424

■ Using a T-shaped spacer facilitates the branching of air flow.

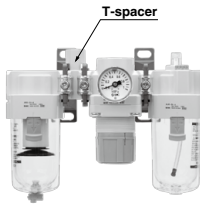

Applicable series

- Air Filter + Regulator + Lubricator (AC10-A to AC40-A)
- Air Filter + Regulator (AC10B-A to AC40B-A)
- Air Filter + Mist Separator + Regulator (AC20C-A to AC40C-A)

### Pressure relief 3 port valve

Page 425

■ With the use of a pressure relief 3 port valve, pressure left in the line can be easily exhausted.

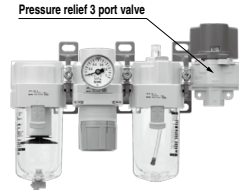

Applicable series

- Air Filter + Regulator + Lubricator (AC20-A to AC40-A)
- Filter Regulator + Lubricator (AC20A-A to AC40A-A)
- Air Filter + Regulator (AC20B-A to AC40B-A)
- Air Filter + Mist Separator + Regulator (AC20C-A to AC40C-A)
- Filter Regulator + Mist Separator (AC20D-A to AC40D-A)

### Cross spacer

Page 425

■ Pipings are possible in all 4 directions.

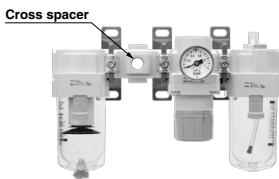

\* Needs to be ordered separately.

### Piping adapter

Page 426

■ A piping adapter allows installation/removal of the component without removing the piping and thus makes maintenance easier.

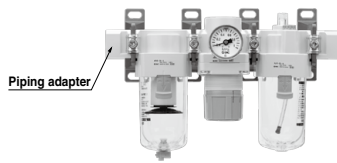

\* Needs to be ordered separately.

**Pressure switch with piping adapter** Page 426

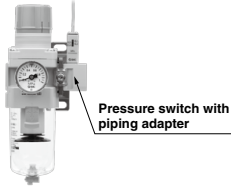

\* Needs to be ordered separately.

**Accessories (Spacer/Spacer with bracket)** Page 427

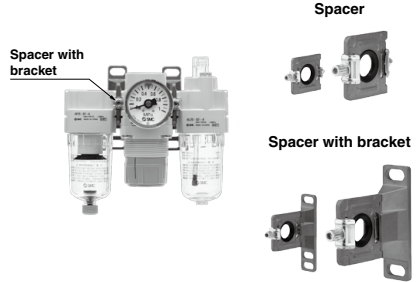

\* Needs to be ordered separately.

**Related Product**

**Modular adapter**

Page 643

Easy modular connections for all equipment!

Example) Air filter + 3 port valve

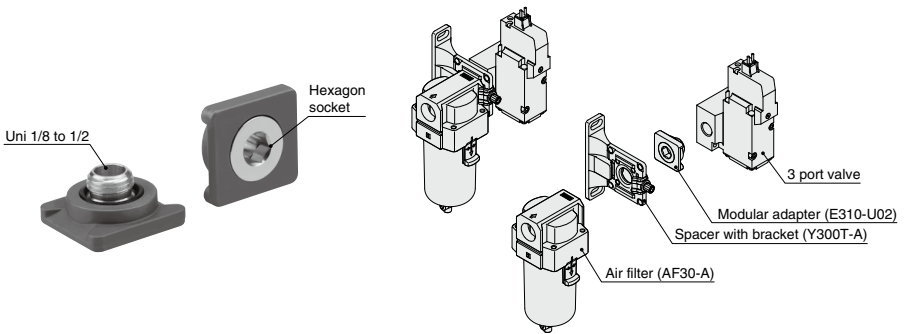

AC-A
AF-A
AF□-A
AR-A
AL-A
AW-A
AC-B
AF-A
AF□-A
AR-A
AL-A
AW-A
AW□
AF-G
E□
AV
AF

# AC10-A to AC40-A

Symbol

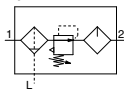

## How to Order

AC **30** - **03** **DG** - **01** - **01** - **A**

①
②
③
④
⑤
⑥

- Option/Semi-standard: Select one each for **a** to **m**.
- Option/Attachment/Semi-standard symbol: When more than one specification is required, indicate in alphanumeric order.  
Example) AC30-F03DM-KSTV-13NR-A

	Symbol	Description	①						
			Body size						
			10	20	25	30	40		
②	Pipe thread type	Nil	Metric thread (M5)						
		N <sup>Note 1)</sup>	Rc						
		F <sup>Note 2)</sup>	NPT						
			G						
+									
③	Port size	M5	M5						
		01	1/8						
		02	1/4						
		03	3/8						
		04	1/2						
		06	3/4						
+									
④	Option <sup>Note 3)</sup>	a	Float type auto drain	Nil	Without auto drain				
			C <sup>Note 4)</sup>	N.C. (Normally closed) Drain port is closed when pressure is not applied.					
			D <sup>Note 5)</sup>	N.O. (Normally open) Drain port is open when pressure is not applied.					
+									
b	Pressure gauge <sup>Note 6)</sup>	Nil	Without pressure gauge						
		G	Round type pressure gauge (without limit indicator)						
		M	Round type pressure gauge (with limit indicator)						
+									
⑤	Attachment	c	Check valve	Nil	Without attachment				
			K	Mounting position: AF+AR+K+AL					
		+							
		d	Pressure switch	Nil	Without attachment				
				S <sup>Note 8)</sup>	Mounting position: AF+AR+S+AL				
		+							
e	T-spacer	Nil	Without attachment						
		T <sup>Note 8)</sup>	Mounting position: AF+T+AR+AL						
+									
f	Pressure relief 3 port valve	Nil	Without attachment						
		V	Mounting position: AF+AR+AL+V						
+									
⑥	Semi-standard	g	Set pressure <sup>Note 9)</sup>	Nil	0.05 to 0.7 MPa setting				
			1	0.02 to 0.2 MPa setting					
		+							
h	Bowl <sup>Note 10)</sup>	Nil	Polycarbonate bowl						
		2	Metal bowl						
		6	Nylon bowl						
		8	Metal bowl with level gauge						
		C	With bowl guard						
		6C	With bowl guard (Nylon bowl)						

# Air Combination **AC10-A to AC40-A Series**

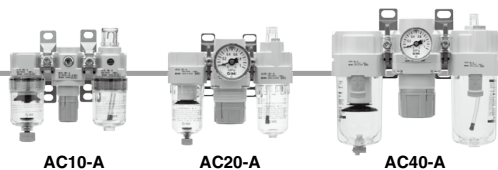

	Symbol	Description	①					
			Body size					
			10	20	25	30	40	
6 Semi-standard	i Air filter drain port <small>Note 13</small>	Nil	With drain cock	●	●	●	●	●
		J <small>Note 14</small>	Drain guide 1/8	—	●	—	—	—
		W <small>Note 15</small>	Drain guide 1/4	—	—	●	●	●
		+	Drain cock with barb fitting (for ø6 x ø4 nylon tube)	—	—	●	●	●
	j Lubricator/lubricant exhaust port	Nil	Without drain cock	●	●	●	●	●
		3 <small>Note 16</small>	Lubricator with drain cock	●	●	●	●	●
	k Exhaust mechanism	Nil	Relieving type	●	●	●	●	●
		N	Non-relieving type	●	●	●	●	●
	l Flow direction	Nil	Flow direction: Left to right	●	●	●	●	●
		R	Flow direction: Right to left	●	●	●	●	●
m Pressure unit	Nil	Name plate and pressure gauge in imperial units: MPa	●	●	●	●	●	
	Z <small>Note 17</small>	Name plate, caution plate for bowl, and pressure gauge in imperial units: psi, °F	○ <small>Note 18</small>	○ <small>Note 18</small>	○ <small>Note 18</small>	○ <small>Note 18</small>	○ <small>Note 18</small>	

Note 1) Drain guide is NPT1/8 (applicable to the AC20-A) and NPT1/4 (applicable to the AC25-A to AC40-A). The auto drain port comes with ø3/8" One-touch fitting (applicable to the AC25-A to AC40-A).

Note 2) Drain guide is G1/8 (applicable to the AC20-A) and G1/4 (applicable to the AC25-A to AC40-A).

Note 3) Option G, M, are not assembled and supplied loose at the time of shipment.

Note 4) When pressure is not applied, condensate which does not start the auto drain mechanism will be left in the bowl. Releasing the residual condensate before ending operations for the day is recommended.

Note 5) If the compressor is small (0.75 kW, discharge flow is less than 100 L/min(ANR)), air leakage from the drain cock may occur during start

of operations. N.C. type is recommended.

Note 6) When the pressure gauge is attached, a 1.0 MPa pressure gauge will be fitted for standard (0.7 MPa) type. 0.4 MPa pressure gauge for 0.2 MPa type (1.0 MPa pressure gauge only for the AC10-A).

Note 7) Not available with piping port size: 06

Note 8) The bracket position varies depending on the T-spacer or pressure switch mounting.

Note 9) Pressure can be set higher than the specification pressure in some cases, but use pressure within the specification range.

Note 10) Refer to Chemical data on page 433 for chemical resistance of the bowl.

Note 11) A bowl guard is provided as standard equipment (polycarbonate).

Note 12) A bowl guard is provided as standard equipment (nylon).

Note 13) Float type auto drain. The combination of C and D is not possible.

Note 14) Without a valve function

Note 15) The combination of metal bowl: 2 and 8 is not available.

Note 16) When choosing with W: Filter drain port, the drain cock of a lubricator will be with barb fittings.

Note 17) For pipe thread type: M5, NPT. This product is for overseas use only according to the new Measurement Law. (The SI unit type is provided for use in Japan.) MPa and psi are shown together on the pressure unit. Cannot be used with M: Round pressure gauge (with color zone). Available by request for special.

Note 18) ○: For pipe thread type: M5, NPT only

## Standard Specifications

Model	AC10-A	AC20-A	AC25-A	AC30-A	AC40-A	AC40-06-A	
Component	Air Filter [AF]	AF10-A	AF20-A	AF30-A	AF30-A	AF40-A	AF40-06-A
	Regulator [AR]	AR10-A	AR20-A	AR25-A	AR30-A	AR40-A	AR40-06-A
	Lubricator [AL]	AL10-A	AL20-A	AL30-A	AL30-A	AL40-A	AL40-06-A
Port size	M5 x 0.8	1/8, 1/4	1/4, 3/8	1/4, 3/8	1/4, 3/8, 1/2	3/4	
Pressure gauge port size [AR]	1/16			1/8			
Fluid	Air						
Ambient and fluid temperature	-5 to 60 °C (with no freezing)						
Proof pressure	1.5 MPa						
Max. operating pressure	1.0 MPa						
Set pressure range [AR]	0.05 to 0.7 MPa						
Nominal filtration rating [AF]	5 µm						
Recommended lubricant [AL]	Class 1 turbine oil (ISO VG32)						
Bowl material [AF/AL]	Polycarbonate						
Bowl guard [AF/AL]	—	Semi-standard (Steel)	Standard (Polycarbonate)				
Construction [AR]	Relieving type						
Weight (kg)	0.27	0.40	0.68	0.83	1.53	1.66	

- AC-A
- AF-A
- AF□-A
- AR-A
- AL-A
- AW-A
- AC-B
- AF-A
- AF□-A
- AR-β
- AL-A
- AW-β
- AW□
- AG
- E□
- AV
- AF

# AC10-A to AC40-A Series

## Flow Rate Characteristics (Representative values)

Condition: Inlet pressure 0.7 MPa

**AC10-A** M5 x 0.8

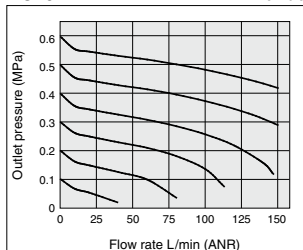

**AC20-A** Rc1/4

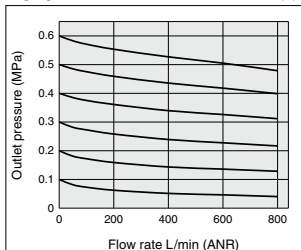

**AC25-A** Rc3/8

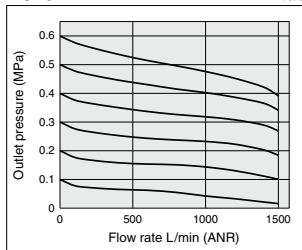

**AC30-A** Rc3/8

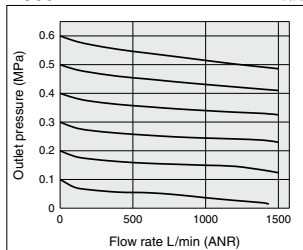

**AC40-A** Rc1/2

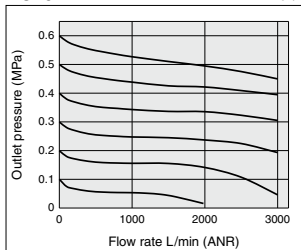

**AC40-06-A** Rc3/4

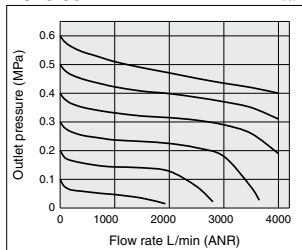

## Pressure Characteristics (Representative values)

Conditions: Inlet pressure 0.7 MPa, Outlet pressure 0.2 MPa, Flow rate 20 L/min (ANR)

**AC10-A**

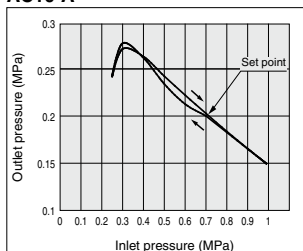

**AC20-A**

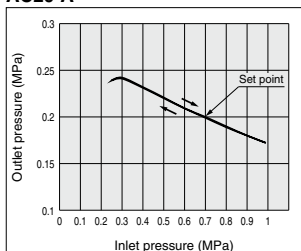

**AC25-A**

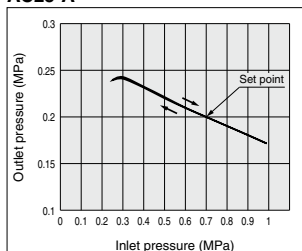

**AC30-A**

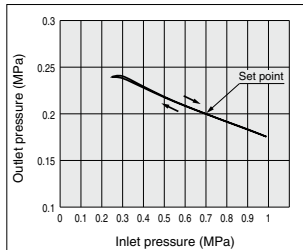

**AC40-A/AC40-06-A**

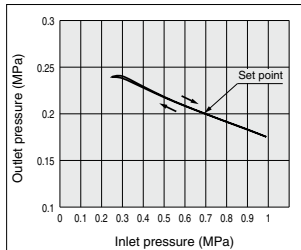



## ⚠ Specific Product Precautions

Be sure to read this before handling the products. Refer to back page 50 for Safety Instructions and pages 387 to 391 for F.R.L. Precautions.

### Piping

#### ⚠ Warning

- When mounting a check valve, make sure the arrow (IN side) points in the correct direction of air flow.

### Air Supply

#### ⚠ Caution

- Use an air filter with 5 μm or less filtration rating on the inlet side of the valve to avoid any damage to the seat caused by dust when mounting a pressure relief 3 port valve on the inlet side.

### Mounting/Adjustment

#### ⚠ Caution

- When the bowl is installed on the air filter, filter regulator, lubricator, mist separator, or micro mist separator (AC25-A to AC40-A), install them so that the lock button lines up to the groove of the front (or the back) of the body to avoid drop or damage of the bowl.

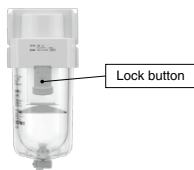

### Selection

#### ⚠ Warning

- Float type auto drain

Operate under the following conditions to avoid malfunction.

<N.O. type>

  - Operating compressor: 0.75 kW (100 L/min (ANR)) or more.

When using 2 or more auto drains, multiply the value above by the number of auto drains to find the capacity of the compressors you will need.

For example, when using 2 auto drains, 1.5 kW (200 L/min (ANR)) of the compressor capacity is required.

  - Operating pressure: 0.1 MPa or more

<N.C. type>

  - Operating pressure for AD27-A: 0.1 MPa or more
  - Operating pressure for AD37-A/AD47-A: 0.15 MPa or more
- When a pressure release 3 port valve is mounted on the inlet side of the regulator or filter regulator, the residual pressure can be released to the inlet side. However, if the set pressure is 0.15 MPa or less, the residual pressure may not be released.

When using the pressure release 3 port valve at a set pressure level of 0.15 MPa or less, it is recommended to use a regulator with backflow function.

#### ⚠ Caution

- When releasing air at the intermediate position using a T-spacer on the inlet side of the lubricator, lubricant may back flow. Therefore, releasing air that does not contain traces of lubricant is not possible.

To release air that does not contain traces of lubricant, use a check valve (AKM series) on the inlet side of the lubricator to prevent a backflow of the lubricant.
- If a pressure relief 3 port valve is mounted on the inlet side of the lubricator, causing a backflow of air, it can result in a backflow of oil or damage to internal parts. Do not use it in this fashion.
- An F.R.L. unit shipped from the plant has its model number labeled. However, components that are combined together during the distribution process do not have a label on them.
- For AC10 series products with a pressure gauge, when connected to the modular unit, there will be interference preventing the use of tools; therefore, the pressure gauge cannot be mounted or removed in such a state.

Mount or remove the pressure gauge from the AR/AW10-A single unit product before connecting it to the modular unit.

To screw in the pressure gauge, make sure to insert a wrench into the wrench flats before turning the gauge.

If the pressure gauge is screwed in by holding some other part of it, air leakage or damage may result.

It is possible to have the product shipped with the pressure gauge already mounted. Please contact your local sales representative for more details.

AC-A

AF-A

AF-A

AR-A

AL-A

AW-A

AC-B

AF-A

AF-A

AF-A

AR-B

AL-A

AW-B

AW

AF-G

E

AV

AF

# AC10-A to AC40-A Series

## Dimensions

### AC10-A/AC20-A

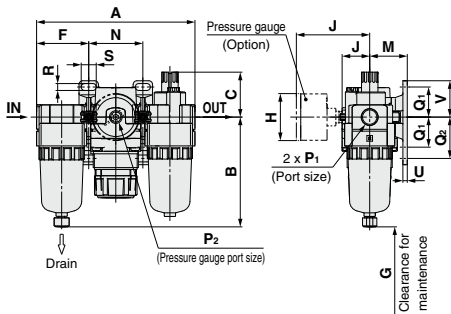

### AC25-A to AC40-06-A

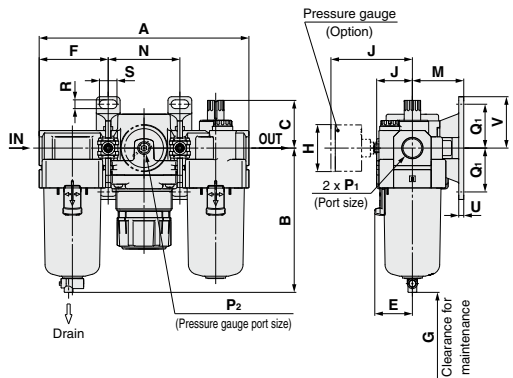

Applicable model	AC10-A/AC20-A		AC20-A		AC25-A to AC40-06-A
Optional/Semi-standard specifications	With auto drain (N.C.)	Metal bowl	With drain guide	Metal bowl with drain guide	With auto drain (N.O./N.C.)
Dimensions					

Applicable model	AC25-A to AC40-06-A					
Optional/Semi-standard specifications	Metal bowl	Metal bowl with drain guide	Metal bowl with level gauge	Metal bowl with level gauge, with drain guide	With drain guide	Drain cock with barb fitting
Dimensions						

Model	Standard specifications																
	P <sub>1</sub>	P <sub>2</sub>	A	B	C	E	F	G	J	Bracket mount							
										M	N	Q <sub>1</sub>	Q <sub>2</sub>	R	S	U	V
AC10-A	M5 x 0.8	1/16	87	59.9	25.5	—	28	35	12.5	25	31	20	27	4.5	6.8	3	24.5
AC20-A	1/8, 1/4	1/8	126.4	87.6	35.9	—	41.6	60	23.4	30	43.2	24	33	5.5	12	3.5	29
AC25-A	1/4, 3/8	1/8	167.4	115.1	38.1	30	55.1	80	30.5	41	57.2	35	—	7	14	4	41
AC30-A	1/4, 3/8	1/8	167.4	115.1	38.1	30	55.1	80	30.5	41	57.2	35	—	7	14	4	41
AC40-A	1/4, 3/8, 1/2	1/8	220.4	147.1	39.8	38.4	72.6	110	36.1	50	75.2	40	—	9	18	5	48
AC40-06-A	3/4	1/8	235.4	149.1	37.8	38.4	77.6	110	39.6	50	80.2	40	—	9	18	5	48

Model	Optional specifications						Semi-standard specifications					
	Round type pressure gauge		Round type pressure gauge (with color zone)		With auto drain	With barb fitting	With drain guide	Metal bowl	Metal bowl with drain guide	Metal bowl with level gauge	Metal bowl with level gauge, with drain guide	
	H	J	H	J	B	B	B	B	B	B	B	
AC10-A	ø26	26	—	—	77.9	—	—	59.3	—	—	—	
AC20-A	ø37.5	58.5	ø37.5	59.5	104.9	—	91.4	87.4	93.9	—	—	
AC25-A	ø37.5	58.5	ø37.5	59.5	156.8	123.6	121.9	117.6	122.1	137.6	142.1	
AC30-A	ø37.5	65	ø37.5	66	156.8	123.6	121.9	117.6	122.1	137.6	142.1	
AC40-A	ø42.5	72	ø42.5	72	186.9	155.6	153.9	149.6	154.1	169.6	174.1	
AC40-06-A	ø42.5	72	ø42.5	72	188.9	157.6	155.9	151.6	156.1	171.6	176.1	

<b>AC-A</b>
<b>AF-A</b>
<b>AF□-A</b>
<b>AR-A</b>
<b>AL-A</b>
<b>AW-A</b>
<b>AC-B</b>
<b>AF-A</b>
<b>AF□-A</b>
<b>AR<sup>A</sup><sub>B</sub></b>
<b>AL-A</b>
<b>AW<sup>B</sup></b>
<b>AW□</b>
<b>A□G</b>
<b>E□</b>
<b>AV</b>
<b>AF</b>

# AC10A-A to AC40A-A

Symbol

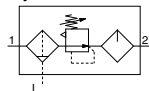

## How to Order

AC **30** A - **03** DG - - - A

① ② ③ ④ ⑤ ⑥

- Option/Semi-standard: Select one each for a to l.
- Option/Attachment/Semi-standard symbol: When more than one specification is required, indicate in alphanumeric order.  
Example) AC30A-F03DM-KSV-13NR-A

	Symbol	Description	①						
			Body size						
			10	20	30	40			
②	Pipe thread type	Nil	Metric thread (M5)						
		N <sup>Note 1)</sup>	—	●	●	●			
		F <sup>Note 2)</sup>	—	●	●	●			
			—	●	●	●			
+									
③	Port size	M5	●	—	—	—			
		01	—	—	—	—			
		02	—	●	●	●			
		03	—	—	●	●			
		04	—	—	—	●/2			
		06	—	—	—	●			
+									
④	Option <sup>Note 3)</sup>	a	Float type auto drain	Nil	Without auto drain	●	●	●	●
			C <sup>Note 4)</sup>	N.C. (Normally closed) Drain port is closed when pressure is not applied.	●	●	●	●	
			D <sup>Note 5)</sup>	N.O. (Normally open) Drain port is open when pressure is not applied.	—	—	●	●	
+									
④	b	Pressure gauge <sup>Note 6)</sup>	Without pressure gauge	Nil	●	●	●	●	
			Round type pressure gauge (without limit indicator)	G	●	—	—	—	
			Round type pressure gauge (with limit indicator)	—	—	●	●	●	
+									
⑤	Attachment	c	Without attachment	Nil	●	●	●	●	
			Mounting position: AW+K+AL	K	—	●	●	●/Note 7)	
		+							
⑤	d	Without attachment	Nil	●	●	●	●		
		Mounting position: AW+S+AL	S <sup>Note 8)</sup>	—	●	●	●		
+									
⑤	e	Without attachment	Nil	●	●	●	●		
		Mounting position: AW+AL+V	V	—	●	●	●		
+									
⑥	f	Set pressure <sup>Note 9)</sup>	Nil	●	●	●	●		
		0.05 to 0.7 MPa setting	1	●	●	●	●		
+									
⑥	g	Bow <sup>Note 10)</sup>	Polycarbonate bowl	Nil	●	●	●	●	
			Metal bowl	2	●	●	●	●	
			Nylon bowl	6	●	●	●	●	
			Metal bowl with level gauge	8	—	—	●	●	
			With bowl guard	C	—	●	—	—/Note 11)	—/Note 11)
			With bowl guard (Nylon bowl)	6C	—	●	—	—/Note 12)	—/Note 12)
+									
⑥	h	Filter regulator drain port <sup>Note 13)</sup>	With drain cock	Nil	●	●	●	●	
			Drain guide 1/8	J <sup>Note 14)</sup>	—	—	—	—	
			Drain guide 1/4	—	—	—	●	●	
			Drain cock with barb fitting (for ø6 x ø4 nylon tube)	W <sup>Note 15)</sup>	—	—	●	●	

# Air Combination **AC10A-A to AC40A-A Series**

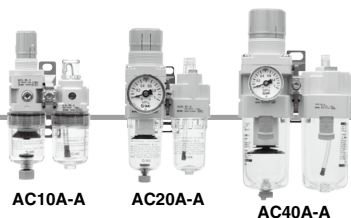

AC10A-A

AC20A-A

AC40A-A

		Symbol	Description	①				
				Body size				
				10	20	30	40	
⑥	i	Lubricator lubricant exhaust port	Nil	Without drain cock	●	●	●	●
			3 <small>Note 16)</small>	Lubricator with drain cock	●	●	●	●
			+					
	j	Exhaust mechanism	Nil	Relieving type	●	●	●	●
			N	Non-relieving type	●	●	●	●
			+					
	k	Flow direction	Nil	Flow direction: Left to right	●	●	●	●
			R	Flow direction: Right to left	●	●	●	●
			+					
	l	Pressure unit	Nil	Name plate and pressure gauge in imperial units: MPa	●	●	●	●
Z <small>Note 17)</small>			Name plate, caution plate for bowl, and pressure gauge in imperial units: psi, °F	○ <small>Note 18)</small>	○ <small>Note 18)</small>	○ <small>Note 18)</small>	○ <small>Note 18)</small>	

Note 1) Drain guide is NPT1/8 (applicable to the AC20A-A) and NPT1/4 (applicable to the AC30A-A to AC40A-A). The auto drain port comes with ø3/8" One-touch fitting (applicable to the AC30A-A to AC40A-A).

Note 2) Drain guide is G1/8 (applicable to the AC20A-A) and G1/4 (applicable to the AC30A-A to AC40A-A).

Note 3) Option G, M are not assembled and supplied loose at the time of shipment.

Note 4) When pressure is not applied, condensate which does not start the auto drain mechanism will be left in the bowl. Releasing the residual condensate before ending operations for the day is recommended.

Note 5) If the compressor is small (0.75 kW, discharge flow is less than 100 L/min[ANR]), air leakage from the drain cock may occur during start of operations. N.C. type is

recommended.

Note 6) When the pressure gauge is attached, a 1.0 MPa pressure gauge will be fitted for standard (0.7 MPa) type. 0.4 MPa pressure gauge for 0.2 MPa type (1.0 MPa pressure gauge only for the AC10A-A).

Note 7) Not available with piping port size: 06

Note 8) The bracket position varies depending on the pressure switch mounting.

Note 9) Pressure can be set higher than the specification pressure in some cases, but use pressure within the specification range.

Note 10) Refer to Chemical data on page 433 for chemical resistance of the bowl.

Note 11) A bowl guard is provided as standard equipment (polycarbonate).

Note 12) A bowl guard is provided as standard equipment (nylon).

Note 13) Float type auto drain: The combination of C and D is not possible.

Note 14) Without a valve function

Note 15) The combination of metal bowl: 2 and 8 is not available.

Note 16) When choosing with W: Filter regulator drain port, the drain cock of a lubricator will be with barb fitting.

Note 17) For pipe thread type: M5, NPT. This product is for overseas use only according to the new Measurement Law. (The SI unit type is provided for use in Japan.) MPa and psi are shown together on the pressure unit. Cannot be used with M: Round pressure gauge (with color zone). Available by request for special.

Note 18) ○: For pipe thread type: M5, NPT only

## Standard Specifications

Model		AC10A-A	AC20A-A	AC30A-A	AC40A-A	AC40A-06-A
Component	Filter Regulator [AW]	AW10-A	AW20-A	AW30-A	AW40-A	AW40-06-A
	Lubricator [AL]	AL10-A	AL20-A	AL30-A	AL40-A	AL40-06-A
Port size		M5 x 0.8	1/8, 1/4	1/4, 3/8	1/4, 3/8, 1/2	3/4
Pressure gauge port size [AW]		1/16			1/8	
Fluid		Air				
Ambient and fluid temperature		-5 to 60 °C (with no freezing)				
Proof pressure		1.5 MPa				
Maximum operating pressure		1.0 MPa				
Set pressure range [AW]		0.05 to 0.7 MPa				
Nominal filtration rating [AW]		5 μm				
Recommended lubricant [AL]		Class 1 turbine oil (ISO VG32)				
Bowl material [AW/AL]		Polycarbonate				
Bowl guard [AW/AL]		—	Semi-standard (Steel)	Standard (Polycarbonate)		
Construction [AW]		Relieving type				
Weight (kg)		0.20	0.34	0.67	1.24	1.35

# AC10A-A to AC40A-A Series

## Dimensions

### AC10A-A/AC20A-A

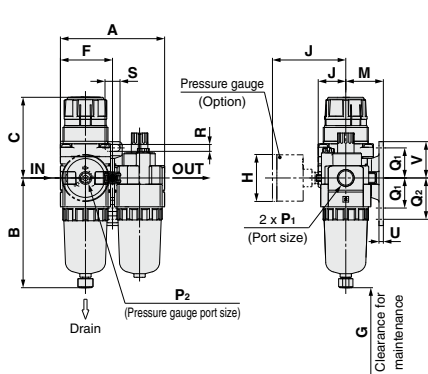

### AC30A-A to AC40A-06-A

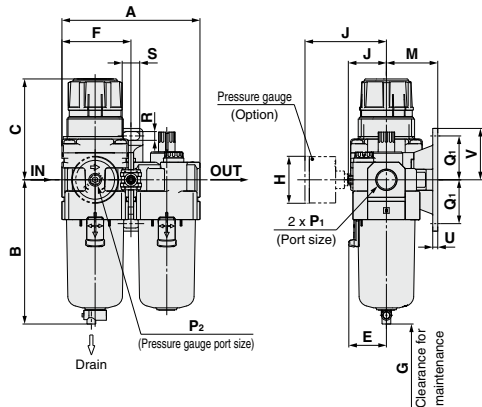

Applicable model	AC10A-A/AC20A-A		AC20A-A		AC30A-A to AC40A-06-A
Optional/Semi-standard specifications	With auto drain (N.C.)	Metal bowl	With drain guide	Metal bowl with drain guide	With auto drain (N.O./N.C.)
Dimensions					

Applicable model	AC30A-A to AC40A-06-A					
Optional/Semi-standard specifications	Metal bowl	Metal bowl with drain guide	Metal bowl with level gauge	Metal bowl with level gauge, with drain guide	With drain guide	Drain cock with barb fitting
Dimensions						

Model	Standard specifications															
	P <sub>1</sub>	P <sub>2</sub>	A	B	C <sup>(Note)</sup>	E	F	G	J	Bracket mount						
										M	Q <sub>1</sub>	Q <sub>2</sub>	R	S	U	V
AC10A-A	M5 x 0.8	1/16	56	59.9	47.4	—	28	25	12.5	25	20	27	4.5	6.8	3	24.5
AC20A-A	1/8, 1/4	1/8	83.2	87.6	67.4	—	41.6	60	23.4	30	24	33	5.5	12	3.5	29
AC30A-A	1/4, 3/8, 1/2	1/8	110.2	115.1	83.5	30	55.1	80	30.5	41	35	—	7	14	4	41
AC40A-A	1/4, 3/8, 1/2	1/8	145.2	147.1	100	38.4	72.6	110	36.1	50	40	—	9	18	5	48
AC40A-06-A	3/4	1/8	155.2	149.1	101.5	38.4	77.6	110	39.6	50	40	—	9	18	5	48

Model	Optional specifications				Semi-standard specifications							
	Round type pressure gauge		Round type pressure gauge (with color zone)		With auto drain	With barb fitting	With drain guide	Metal bowl	Metal bowl with drain guide	Metal bowl with level gauge	Metal bowl with level gauge, with drain guide	
	H	J	H	J	B	B	B	B	B	B	B	
AC10A-A	ø26	26	—	—	77.9	—	—	59.3	—	—	—	
AC20A-A	ø37.5	58.5	ø37.5	59.5	104.9	—	91.4	87.4	93.9	—	—	
AC30A-A	ø37.5	65	ø37.5	66	156.8	123.6	121.9	117.6	122.1	137.6	142.1	
AC40A-A	ø42.5	72	ø42.5	72	186.9	155.6	153.9	149.6	154.1	169.6	174.1	
AC40A-06-A	ø42.5	72	ø42.5	72	188.9	157.6	155.9	151.6	156.1	171.6	176.1	

Note) The dimension of C is the length when the filter regulator knob is unlocked.



<b>AC-A</b>
<b>AF-A</b>
<b>AF□-A</b>
<b>AR-A</b>
<b>AL-A</b>
<b>AW-A</b>
<b>AC-B</b>
<b>AF-A</b>
<b>AF□-A</b>
<b>AR<sup>A</sup><sub>B</sub></b>
<b>AL-A</b>
<b>AW<sup>B</sup></b>
<b>AW□</b>
<b>A□G</b>
<b>E□</b>
<b>AV</b>
<b>AF</b>

# AC10B-A to AC40B-A

Symbol



## How to Order

AC **30** B- **03** DG - - - A

①
②
③
④
⑤
⑥

• Option/Semi-standard: Select one each for a to j.  
 • Option/Attachment/Semi-standard symbol: When more than one specification is required, indicate in alphanumeric order.  
 Example) AC30B-F03DM-SV-1NR-A

	Symbol	Description	①					
			Body size					
			10	20	25	30	40	
②	Pipe thread type	Nil	Metric thread (M5)					
		N <sup>Note 1)</sup>	Rc					
		F <sup>Note 2)</sup>	NPT					
			G					
+								
③	Port size	M5	M5					
		01	1/8					
		02	1/4					
		03	3/8					
		04	1/2					
		06	3/4					
+								
④	a	Nil	Without auto drain					
		C <sup>Note 4)</sup>	N.C. (Normally closed) Drain port is closed when pressure is not applied.					
		D <sup>Note 5)</sup>	N.O. (Normally open) Drain port is open when pressure is not applied.					
+								
b	Pressure gauge <sup>Note 6)</sup>	Nil	Without pressure gauge					
		G	Round type pressure gauge (without limit indicator)					
		M	Round type pressure gauge (with limit indicator)					
+								
⑤	c	Nil	Without attachment					
		S <sup>Note 7)</sup>	Mounting position: AF+S+AR					
		T <sup>Note 7)</sup>	Mounting position: AF+T+AR					
+								
d	Pressure relief 3 port valve	Nil	Without attachment					
		V	Mounting position: AF+AR+V					
		V1 <sup>Note 8)</sup>	Mounting position: V+AF+AR					
+								
⑥	e	Nil	0.05 to 0.7 MPa setting					
		1	0.02 to 0.2 MPa setting					
	+							
	f	Bowl <sup>Note 10)</sup>	Nil	Polycarbonate bowl				
			2	Metal bowl				
			6	Nylon bowl				
			8	Metal bowl with level gauge				
			C	With bowl guard				
			6C	With bowl guard (Nylon bowl)				
	+							
g	Air filter drain port <sup>Note 13)</sup>	Nil	With drain cock					
		J <sup>Note 14)</sup>	Drain guide 1/8					
			Drain guide 1/4					
		W <sup>Note 15)</sup>	Drain cock with barb fitting (for ø6 x ø4 nylon tube)					

# Air Combination **AC10B-A to AC40B-A Series**

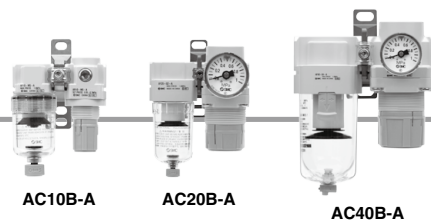

		Symbol	Description	①					
				Body size					
				10	20	25	30	40	
⑥	h	Exhaust mechanism	Nil	Relieving type	●	●	●	●	●
			N	Non-relieving type	●	●	●	●	●
					+				
	i	Flow direction	Nil	Flow direction: Left to right	●	●	●	●	●
			R	Flow direction: Right to left	●	●	●	●	●
					+				
j	Pressure unit	Nil	Name plate and pressure gauge in imperial units: MPa	●	●	●	●	●	
		Z <sup>Note 16)</sup>	Name plate, caution plate for bowl, and pressure gauge in imperial units: psi, °F	○ <sup>Note 17)</sup>	○ <sup>Note 17)</sup>	○ <sup>Note 17)</sup>	○ <sup>Note 17)</sup>	○ <sup>Note 17)</sup>	

Note 1) Drain guide is NPT1/8 (applicable to the AC20B-A) and NPT1/4 (applicable to the AC25B-A to AC40B-A). The auto drain port comes with ø3/8" One-touch fitting (applicable to the AC25B-A to AC40B-A).

Note 2) Drain guide is G1/8 (applicable to the AC20B-A) and G1/4 (applicable to the AC25B-A to AC40B-A).

Note 3) Option G, M are not assembled and supplied loose at the time of shipment.

Note 4) When pressure is not applied, condensate which does not start the auto drain mechanism will be left in the bowl. Releasing the residual condensate before ending operations for the day is recommended.

Note 5) If the compressor is small (0.75 kW, discharge flow is less than 100 L/min(ANR)), air leakage from the drain cock may occur during start of

operations. N.C. type is recommended.

Note 6) When the pressure gauge is attached, a 1.0 MPa pressure gauge will be fitted for standard (0.7 MPa) type. 0.4 MPa pressure gauge for 0.2 MPa type (1.0 MPa pressure gauge only for the AC10B-A).

Note 7) The bracket position varies depending on the T-spacer or pressure switch mounting.

Note 8) Make sure that the outlet pressure is released to atmospheric pressure using a pressure gauge. For V1 specification, use the regulator with a set pressure of 0.15 MPa or more to ensure the pressure release.

Note 9) Pressure can be set higher than the specification pressure in some cases, but use pressure within the specification range.

Note 10) Refer to Chemical data on page 433 for chemical resistance of the bowl.

Note 11) A bowl guard is provided as standard equipment (polycarbonate).

Note 12) A bowl guard is provided as standard equipment (nylon).

Note 13) Float type auto drain: The combination of C and D is not possible.

Note 14) Without a valve function

Note 15) The combination of metal bowl: 2 and 8 is not available.

Note 16) For pipe thread type: M5, NPT. This product is for overseas use only according to the new Measurement Law. (The SI unit type is provided for use in Japan.) MPa and psi are shown together on the pressure unit. Cannot be used with M: Round pressure gauge (with color zone). Available by request for special.

Note 17) ○: For pipe thread type: M5, NPT only

## Standard Specifications

Model		AC10B-A	AC20B-A	AC25B-A	AC30B-A	AC40B-A	AC40B-06-A
Component	Air Filter [AF]	AF10-A	AF20-A	AF30-A	AF30-A	AF40-A	AF40-06-A
	Regulator [AR]	AR10-A	AR20-A	AR25-A	AR30-A	AR40-A	AR40-06-A
Port size		M5 x 0.8	1/8, 1/4	1/4, 3/8	1/4, 3/8	1/4, 3/8, 1/2	3/4
Pressure gauge port size [AR]		1/16		1/8			
Fluid		Air					
Ambient and fluid temperature		-5 to 60 °C (with no freezing)					
Proof pressure		1.5 MPa					
Maximum operating pressure		1.0 MPa					
Set pressure range [AR]		0.05 to 0.7 MPa					
Nominal filtration rating [AF]		5 μm					
Bowl material [AF]		Polycarbonate					
Bowl guard [AF]		—	Semi-standard (Steel)	Standard (Polycarbonate)			
Construction [AR]		Relieving type					
Weight (kg)		0.16	0.28	0.43	0.58	1.05	1.12

# AC10B-A to AC40B-A Series

## Dimensions

### AC10B-A/AC20B-A

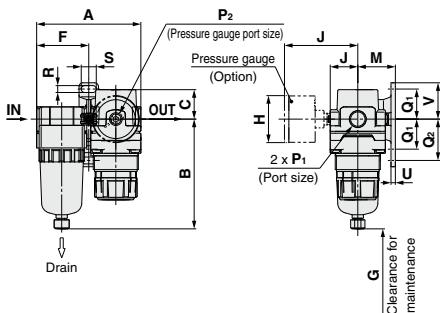

### AC25B-A to AC40B-06-A

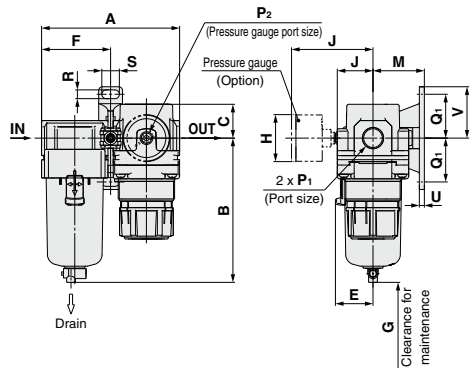

Applicable model	AC10B-A/AC20B-A		AC20B-A		AC25B-A to AC40B-06-A
Optional/Semi-standard specifications	With auto drain (N.C.)	Metal bowl	With drain guide	Metal bowl with drain guide	With auto drain (N.O./N.C.)
Dimensions					
	M5 x 0.8		Width across flats 14	Width across flats 14	N.O.: Black N.C.: Gray Thread type/Rc: G: $\phi 10$ One-touch fitting Thread type/NPT: $\phi 3/8"$ One-touch fitting

Applicable model	AC25B-A to AC40B-06-A					
Optional/Semi-standard specifications	Metal bowl	Metal bowl with drain guide	Metal bowl with level gauge	Metal bowl with level gauge, with drain guide	With drain guide	Drain cock with barb fitting
Dimensions						
		Width across flats 17		Width across flats 17	Width across flats 17	Barb fitting applicable tubing: T0604

Model	Standard specifications															
	P <sub>1</sub>	P <sub>2</sub>	A	B	C	E	F	G	J	Bracket mount						
	M5 x 0.8	1/16	56	59.9	11	—	28	25	12.5	M	Q <sub>1</sub>	Q <sub>2</sub>	R	S	U	V
AC10B-A	M5 x 0.8	1/16	56	59.9	11	—	28	25	12.5	25	20	27	4.5	6.8	3	24.5
AC20B-A	1/8, 1/4	1/8	83.2	87.6	23.5	—	41.6	25	23.4	30	24	33	5.5	12	3.5	29
AC25B-A	1/4, 3/8	1/8	110.2	115.1	23.5	30	55.1	35	30.5	41	35	—	7	14	4	41
AC30B-A	1/4, 3/8	1/8	110.2	115.1	27	30	55.1	35	30.5	41	35	—	7	14	4	41
AC40B-A	1/4, 3/8, 1/2	1/8	145.2	147.1	33.5	38.4	72.6	40	36.1	50	40	—	9	18	5	48
AC40B-06-A	3/4	1/8	155.2	149.1	33.5	38.4	77.6	40	39.6	50	40	—	9	18	5	48

Model	Optional specifications					Semi-standard specifications										
	Round type pressure gauge		Round type pressure gauge (with color zone)		With auto drain	With barb fitting	With drain guide	Metal bowl	Metal bowl with drain guide	Metal bowl with level gauge	Metal bowl with level gauge, with drain guide					
	H	J	H	J	B	B	B	B	B	B	B					
AC10B-A	$\phi 26$	26	—	—	77.9	—	—	59.3	—	—	—					
AC20B-A	$\phi 37.5$	58.5	$\phi 37.5$	59.5	104.9	—	91.4	87.4	93.9	—	—					
AC25B-A	$\phi 37.5$	58.5	$\phi 37.5$	59.5	156.8	123.6	121.9	117.6	122.1	137.6	142.1					
AC30B-A	$\phi 37.5$	65	$\phi 37.5$	66	156.8	123.6	121.9	117.6	122.1	137.6	142.1					
AC40B-A	$\phi 42.5$	72	$\phi 42.5$	72	186.9	155.6	153.9	149.6	154.1	169.6	174.1					
AC40B-06-A	$\phi 42.5$	72	$\phi 42.5$	72	188.9	157.6	155.9	151.6	156.1	171.6	176.1					

<b>AC-A</b>
<b>AF-A</b>
<b>AF□-A</b>
<b>AR-A</b>
<b>AL-A</b>
<b>AW-A</b>
<b>AC-B</b>
<b>AF-A</b>
<b>AF□-A</b>
<b>AR<sup>A</sup><sub>B</sub></b>
<b>AL-A</b>
<b>AW<sup>B</sup></b>
<b>AW□</b>
<b>A□G</b>
<b>E□</b>
<b>AV</b>
<b>AF</b>

Air Combination

Air Filter + Mist Separator + Regulator

# AC20C-A to AC40C-A

Symbol

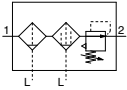

## How to Order

AC **30** C- **03** **DG** - - - **A**

1                      2                      3                      4                      5                      6

• Option/Semi-standard: Select one each for a to j.  
 • Option/Attachment/Semi-standard symbol: When more than one specification is required, indicate in alphanumeric order.  
 Example) AC30C-F03DM-SV-1NR-A

		Symbol	Description	1					
				Body size					
				20	25	30	40		
2	Pipe thread type	Nil	Rc	●	●	●	●		
		N	NPT	●	●	●	●		
		F	G	●	●	●	●		
+									
3	Port size	01	1/8	●	—	—	—		
		02	1/4	●	●	●	●		
		03	3/8	—	●	●	●		
		04	1/2	—	—	—	●		
		06	3/4	—	—	—	●		
+									
4	Option <small>(Note 1)</small>	a	Float type auto drain	Nil	Without auto drain	●	●	●	●
			C <small>(Note 2)</small>	N.C. (Normally closed) Drain port is closed when pressure is not applied.	●	●	●	●	
			D <small>(Note 3)</small>	N.O. (Normally open) Drain port is open when pressure is not applied.	—	●	●	●	
	+								
b	Pressure gauge <small>(Note 4)</small>	Nil	Without pressure gauge	●	●	●	●		
		G	Round type pressure gauge (with limit indicator)	●	●	●	●		
		M	Round type pressure gauge (with color zone)	●	●	●	●		
+									
5	Attachment	c	Pressure switch	Nil	Without attachment	●	●	●	●
			S <small>(Note 5)</small>	Mounting position: AF+AFM+S+AR	●	●	●	●	
		T-spacer	T <small>(Note 5)</small>	Mounting position: AF+AFM+T+AR	●	●	●	●	
		d	Pressure relief 3 port valve	Nil	Without attachment	●	●	●	●
V	Mounting position: AF+AFM+AR+V			●	●	●	●		
V1 <small>(Note 6)</small>	Mounting position: V+AF+AFM+AR			●	●	●	●		
+									
6	e	Set pressure <small>(Note 7)</small>	Nil	0.05 to 0.7 MPa setting	●	●	●	●	
			1	0.02 to 0.2 MPa setting	●	●	●	●	
	+								
	f	Bowl	Nil	Polycarbonate bowl	●	●	●	●	
			2	Metal bowl	●	●	●	●	
			6	Nylon bowl	●	●	●	●	
			8	Metal bowl with level gauge	—	●	●	●	
			C	With bowl guard	●	—	—	—	
			6C	With bowl guard (Nylon bowl)	●	—	—	—	
	+								
	g	Filter Mist separator drain port <small>(Note 12)</small>	Nil	With drain cock	●	●	●	●	
J <small>(Note 8)</small>			Drain guide 1/8	●	—	—	—		
W <small>(Note 11)</small>			Drain cock with barb fitting (for ø6 x ø4 nylon tube)	—	●	●	●		
+									
h	Exhaust mechanism	Nil	Relieving type	●	●	●	●		
		N	Non-relieving type	●	●	●	●		



# Air Combination **AC20C-A to AC40C-A Series**

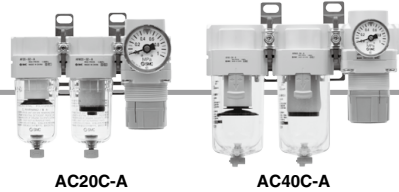

		Symbol	Description	①				
				Body size				
				20	25	30	40	
⑥	i	Flow direction	<b>Nil</b>	Flow direction: Left to right	●	●	●	●
			<b>R</b>	Flow direction: Right to left	●	●	●	●
+								
j	Pressure unit	<b>Nil</b>	Name plate and pressure gauge in imperial units: MPa	●	●	●	●	
		<b>Z</b> (Note 9)	Name plate, caution plate for bowl, and pressure gauge in imperial units: psi, °F	○ (Note 10)	○ (Note 10)	○ (Note 10)	○ (Note 10)	

Note 1) Option G, M are not assembled and supplied loose at the time of shipment.

Note 2) When pressure is not applied, condensate which does not start the auto drain mechanism will be left in the bowl. Releasing the residual condensate before ending operations for the day is recommended.

Note 3) If the compressor is small (0.75 kW, discharge flow is less than 100 L/min(ANR)), air leakage from the drain cock may occur during start of operations. N.C. type is recommended.

Note 4) When the pressure gauge is attached, a 1.0 MPa pressure gauge will be fitted for standard (0.7 MPa) type. 0.4 MPa pressure gauge for 0.2 MPa type.

Note 5) The bracket position varies depending on the T-spacer or pressure switch mounting.

Note 6) Make sure that the outlet pressure is released to atmospheric pressure using a pressure gauge. For V1 specification, use the regulator with a set pressure of 0.15 MPa or more to ensure the pressure release.

Note 7) Pressure can be set higher than the specification pressure in some cases, but use pressure within the specification range.

Note 8) Without a valve function

Note 9) For pipe thread type: NPT. This product is for overseas use only according to the new Measurement Law. (The SI unit type is provided for use in Japan.) MPa and psi are shown together on the pressure unit.

Cannot be used with M: Round pressure gauge (with color zone). Available by request for special.

Note 10) ○: For pipe thread type: NPT only

Note 11) The combination of metal bowl: 2 and 8 is not available.

Note 12) The combination of float type auto drain: C and D is not available.

## Standard Specifications

Model		AC20C-A	AC25C-A	AC30C-A	AC40C-A	AC40C-06-A
Component	Air Filter [AF]	AF20-A	AF30-A	AF30-A	AF40-A	AF40-06-A
	Mist Separator [AFM]	AFM20-A	AFM30-A	AFM30-A	AFM40-A	AFM40-06-A
	Regulator [AR]	AR20-A	AR25-A	AR30-A	AR40-A	AR40-06-A
Port size		1/8, 1/4	1/4, 3/8	1/4, 3/8	1/4, 3/8, 1/2	3/4
Pressure gauge port size [AR]		1/8				
Fluid		Air				
Ambient and fluid temperature		- 5 to 60°C (with no freezing)				
Proof pressure		1.5 MPa				
Maximum operating pressure		1.0 MPa				
Minimum operating pressure		0.05 MPa				
Set pressure range [AR]		0.05 to 0.7 MPa				
Nominal filtration rating [AF/AFM]		AF: 5 μm, AFM: 0.3 μm (99.9% filtered particle size)				
Outlet side oil mist concentration [AFM]		MAX 1.0 mg/m <sup>3</sup> (ANR) (= 0.8 ppm) <small>Note 2) Note 3)</small>				
Rated flow (L/min (ANR)) [AFM] <small>Note 1)</small>		200	450	450	1100	1100
Bowl material [AF/AFM]		Polycarbonate				
Bowl guard [AF/AFM]		Semi-standard (Steel)	Standard (Polycarbonate)			
Construction [AR]		Relieving type				
Weight (kg)		0.39	0.67	0.82	1.53	1.66

Note 1) Conditions: Mist separator inlet pressure: 0.7 MPa. The rated flow varies depending on the inlet pressure. Keep the air flow within the rated flow to prevent an outflow of lubricant to the outlet side.

Note 2) When the compressor oil mist discharge concentration is 30 mg/m<sup>3</sup> (ANR).

Note 3) Bowl seal and other O-rings are slightly lubricated.

# AC20C-A to AC40C-A Series

## Dimensions

### AC20C-A

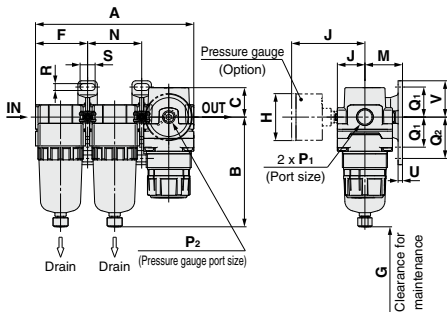

### AC25C-A to AC40C-06-A

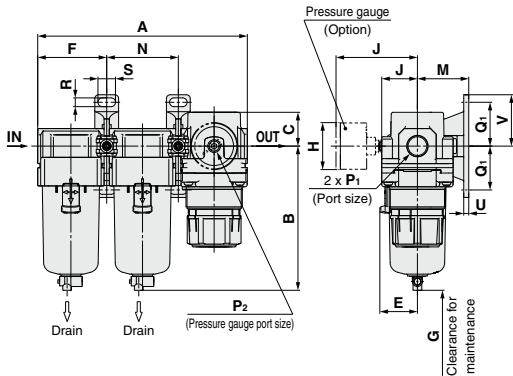

Applicable model	AC20C-A				AC25C-A to AC40C-06-A
Optional/Semi-standard specifications	With auto drain (N.C.)	With drain guide	Metal bowl	Metal bowl with drain guide	With auto drain (N.O./N.C.)
Dimensions	M5 x 0.8	Width across flats 14	1/8	Width across flats 14	1/8 N.O.: Black N.C.: Gray Thread type/Rc: G: ø10 One-touch fitting Thread type/NPT: ø3/8" One-touch fitting

Applicable model	AC25C-A to AC40C-06-A					
Optional/Semi-standard specifications	Metal bowl	Metal bowl with drain guide	Metal bowl with level gauge	Metal bowl with level gauge, with drain guide	With drain guide	Drain cock with barb fitting
Dimensions	17	Width across flats 17	1/4	Width across flats 17	Width across flats 17	Barb fitting applicable tubing: T0604

Model	Standard specifications																							
	P <sub>1</sub>		P <sub>2</sub>		A		B		C		E		F		G		J		Bracket mount					
	M	N	Q <sub>1</sub>	Q <sub>2</sub>	R	S	U	V																
AC20C-A	1/8, 1/4	1/8	126.4	87.6	23.5	—	41.6	40	23.4	30	43.2	24	33	5.5	12	3.5	29							
AC25C-A	1/4, 3/8	1/8	167.4	115.1	23.5	30	55.1	50	30.5	41	57.2	35	—	7	14	4	41							
AC30C-A	1/4, 3/8	1/8	167.4	115.1	27	30	55.1	50	30.5	41	57.2	35	—	7	14	4	41							
AC40C-A	1/4, 3/8, 1/2	1/8	220.4	147.1	33.5	38.4	72.6	75	36.1	50	75.2	40	—	9	18	5	48							
AC40C-06-A	3/4	1/8	235.4	149.1	33.5	38.4	77.6	75	39.6	50	80.2	40	—	9	18	5	48							

Model	Optional specifications						Semi-standard specifications					
	Round type pressure gauge		Round type pressure gauge (with color zone)		With auto drain	With barb fitting	With drain guide	Metal bowl	Metal bowl with drain guide	Metal bowl with level gauge	Metal bowl with level gauge, with drain guide	
	H	J	H	J	B	B	B	B	B	B	B	
AC20C-A	ø37.5	58.5	ø37.5	59.5	104.9	—	91.4	87.4	93.9	—	—	
AC25C-A	ø37.5	58.5	ø37.5	59.5	156.8	123.6	121.9	117.6	122.1	137.6	142.1	
AC30C-A	ø37.5	65	ø37.5	66	156.8	123.6	121.9	117.6	122.1	137.6	142.1	
AC40C-A	ø42.5	72	ø42.5	72	186.9	155.6	153.9	149.6	154.1	169.6	174.1	
AC40C-06-A	ø42.5	72	ø42.5	72	188.9	157.6	155.9	151.6	156.1	171.6	176.1	

<b>AC-A</b>
<b>AF-A</b>
<b>AF□-A</b>
<b>AR-A</b>
<b>AL-A</b>
<b>AW-A</b>
<b>AC-B</b>
<b>AF-A</b>
<b>AF□-A</b>
<b>AR<sup>A</sup><sub>B</sub></b>
<b>AL-A</b>
<b>AW<sup>B</sup></b>
<b>AW□</b>
<b>A□G</b>
<b>E□</b>
<b>AV</b>
<b>AF</b>

# AC20D-A to AC40D-A

Symbol

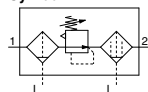

## How to Order

AC **30** D- **03** DG - - - A

①
②
③
④
⑤
⑥

- Option/Semi-standard: Select one each for a to j.
- Option/Attachment/Semi-standard symbol: When more than one specification is required, indicate in alphanumeric order.  
Example) AC30D-F03DM-SV-1NR-A

		Symbol	Description	①				
				Body size				
				20	30	40		
②	Pipe thread type	Nil	Rc	●	●	●		
		N	NPT	●	●	●		
		F	G	●	●	●		
+								
③	Port size	01	1/8	●	—	—		
		02	1/4	●	●	●		
		03	3/8	—	●	●		
		04	1/2	—	—	●		
		06	3/4	—	—	●		
+								
④	Option <small>Note 1)</small>	a	Float type auto drain	Nil	Without auto drain	●	●	●
			C <sup>Note 2)</sup>	N.C. (Normally closed) Drain port is closed when pressure is not applied.	●	●	●	
			D <sup>Note 3)</sup>	N.O. (Normally open) Drain port is open when pressure is not applied.	—	●	●	
+								
④	b	Pressure gauge <sup>Note 4)</sup>	Nil	Without pressure gauge	●	●	●	
			G	Round type pressure gauge (with limit indicator)	●	●	●	
			M	Round type pressure gauge (with color zone)	●	●	●	
+								
⑤	Attachment	c	Pressure switch	Nil	Without attachment	●	●	●
			S <sup>Note 5)</sup>	Mounting position: AW+S+AFM	●	●	●	
			+					
⑤	d	Pressure relief 3 port valve	Nil	Without attachment	●	●	●	
			V	Mounting position: AW+AFM+V	●	●	●	
			V1 <sup>Note 6)</sup>	Mounting position: V+AW+AFM	●	●	●	
+								
⑥	e	Set pressure <sup>Note 7)</sup>	Nil	0.05 to 0.7 MPa setting	●	●	●	
			1	0.02 to 0.2 MPa setting	●	●	●	
			+					
⑥	f	Bowl	Nil	Polycarbonate bowl	●	●	●	
			2	Metal bowl	●	●	●	
			6	Nylon bowl	●	●	●	
			8	Metal bowl with level gauge	—	—	●	
			C	With bowl guard	●	—	—	
			6C	With bowl guard (Nylon bowl)	●	—	—	
+								
⑥	g	Filter regulator Mist separator drain port <sup>Note 12)</sup>	Nil	With drain cock	●	●	●	
			J <sup>Note 8)</sup>	Drain guide 1/8	—	—	—	
			W <sup>Note 11)</sup>	Drain guide 1/4	—	●	●	
			—	Drain cock with barb fitting (for ø6 x ø4 nylon tube)	—	●	●	
+								
⑥	h	Exhaust mechanism	Nil	Relieving type	●	●	●	
			N	Non-relieving type	●	●	●	
+								
⑥	i	Flow direction	Nil	Flow direction: Left to right	●	●	●	
			R	Flow direction: Right to left	●	●	●	

# Air Combination **AC20D-A to AC40D-A Series**

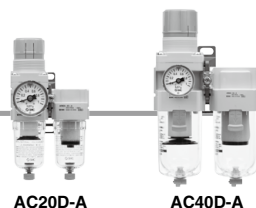

	Symbol	Description	①		
			Body size		
			20	30	40
⑥	j	Pressure unit	Nil	●	●
			Z <sup>Note 9)</sup>	○ <sup>Note 10)</sup>	○ <sup>Note 10)</sup>
Name plate and pressure gauge in imperial units: MPa			○ <sup>Note 10)</sup>	○ <sup>Note 10)</sup>	○ <sup>Note 10)</sup>
Name plate, caution plate for bowl, and pressure gauge in imperial units: psi, °F					

Note 1) Option G, M are not assembled and supplied loose at the time of shipment.

Note 2) When pressure is not applied, condensate which does not start the auto drain mechanism will be left in the bowl. Releasing the residual condensate before ending operations for the day is recommended.

Note 3) If the compressor is small (0.75 kW, discharge flow is less than 100 L/min(ANR)), air leakage from the drain cock may occur during start of operations. N.C. type is recommended.

Note 4) When the pressure gauge is attached, a 1.0 MPa pressure gauge will be fitted for standard (0.7 MPa) type. 0.4 MPa pressure gauge for 0.2 MPa type.

Note 5) The bracket position varies depending on the pressure switch mounting.

Note 6) Make sure that the outlet pressure is released to atmospheric pressure using a pressure gauge.  
For V1 specification, use the regulator with a set pressure of 0.15 MPa or more to ensure the pressure release.

Note 7) Pressure can be set higher than the specification pressure in some cases, but use pressure within the specification range.

Note 8) Without a valve function

Note 9) For pipe thread type: NPT. This product is for overseas use only according to the new Measurement Law. (The SI unit type is provided for use in Japan.) MPa and psi are shown together on the pressure unit. Cannot be used with M: Round pressure gauge (with color zone). Available by request for special.

Note 10) ○: For pipe thread type: NPT only

Note 11) The combination of metal bowl: 2 and 8 is not available.

Note 12) The combination of float type auto drain: C and D is not available.

## Standard Specifications

Model		AC20D-A	AC30D-A	AC40D-A	AC40D-06-A
Component	Filter Regulator [AW]	AW20-A	AW30-A	AW40-A	AW40-06-A
	Mist Separator [AFM]	AFM20-A	AFM30-A	AFM40-A	AFM40-06-A
Port size		1/8, 1/4	1/4, 3/8	1/4, 3/8, 1/2	3/4
Pressure gauge port size [AW]		1/8			
Fluid		Air			
Ambient and fluid temperature		- 5 to 60°C (with no freezing)			
Proof pressure		1.5 MPa			
Maximum operating pressure		1.0 MPa			
Minimum operating pressure		0.05 MPa			
Set pressure range [AW]		0.05 to 0.7 MPa			
Nominal filtration rating [AW/AFM]		AW: 5 μm, AFM: 0.3 μm (99.9% filtered particle size)			
Rated flow (L/min (ANR)) [AFM] <sup>Note 1)</sup>		150	330	800	800
Outlet side oil mist concentration [AFM] <sup>Note 2)3)</sup>		MAX 1.0 mg/m <sup>3</sup> (ANR) (= 0.8 ppm)			
Bowl material [AW/AFM]		Polycarbonate			
Bowl guard [AW/AFM]		Semi-standard (Steel)	Standard (Polycarbonate)		
Construction [AW]		Relieving type			
Weight (kg)		0.33	0.66	1.24	1.35

Note 1) Conditions: Mist separator inlet pressure: 0.5 MPa; The rated flow varies depending on the inlet pressure.

Keep the air flow within the rated flow to prevent an outflow of lubricant to the outlet side.

Note 2) When the compressor oil mist discharge concentration is 30 mg/m<sup>3</sup> (ANR).

Note 3) Bowl seal and other O-rings are slightly lubricated.

# AC20D-A to AC40D-A Series

## Dimensions

### AC20D-A

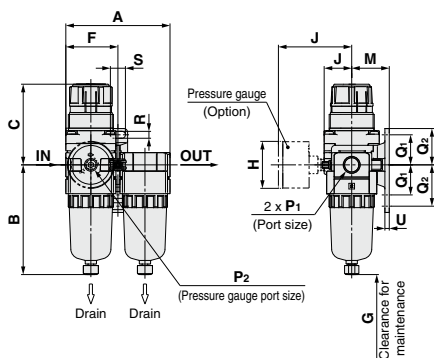

### AC30D-A to AC40D-06-A

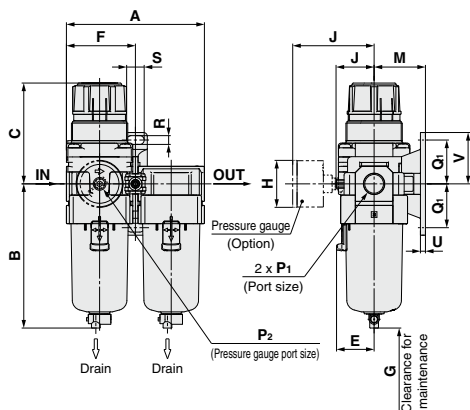

Applicable model	AC20D-A				AC30D-A to AC40D-06-A
Optional/Semi-standard specifications	With auto drain (N.C.)	With drain guide	Metal bowl	Metal bowl with drain guide	With auto drain (N.O./N.C.)
Dimensions					

Applicable model	AC30D-A to AC40D-06-A					
Optional/Semi-standard specifications	Metal bowl	Metal bowl with drain guide	Metal bowl with level gauge	Metal bowl with level gauge, with drain guide	With drain guide	Drain cock with barb fitting
Dimensions						

Model	Standard specifications															
	P <sub>1</sub>	P <sub>2</sub>	A	B	C <sup>(Note)</sup>	E	F	G	J	Bracket mount						
	M	Q <sub>1</sub>	Q <sub>2</sub>	R	S	U	V									
AC20D-A	1/8, 1/4	1/8	83.2	87.6	67.4	—	41.6	40	23.4	30	24	33	5.5	12	3.5	29
AC30D-A	1/4, 3/8, 1/2	1/8	110.2	115.1	83.5	30	55.1	50	30.5	41	35	—	7	14	4	41
AC40D-A	1/4, 3/8, 1/2	1/8	145.2	147.1	100	38.4	72.6	75	36.1	50	40	—	9	18	5	48
AC40D-06-A	3/4	1/8	155.2	149.1	101.5	38.4	77.6	75	39.6	50	40	—	9	18	5	48

Model	Optional specifications						Semi-standard specifications					
	Round type pressure gauge		Round type pressure gauge (with color zone)		With auto drain	With barb fitting	With drain guide	Metal bowl	Metal bowl with drain guide	Metal bowl with level gauge	Metal bowl with level gauge, with drain guide	
	H	J	H	J	B	B	B	B	B	B	B	
AC20D-A	ø37.5	58.5	ø37.5	59.5	104.9	—	91.4	87.4	93.9	—	—	
AC30D-A	ø37.5	65	ø37.5	66	156.8	123.6	121.9	117.6	122.1	137.6	142.1	
AC40D-A	ø42.5	72	ø42.5	72	186.9	155.6	153.9	149.6	154.1	169.6	174.1	
AC40D-06-A	ø42.5	72	ø42.5	72	188.9	157.6	155.9	151.6	156.1	171.6	176.1	

Note) The dimension of C is the length when the filter regulator knob is unlocked.



# Air Combination AC Series Options/Attachments

## Options/Attachments/Part No.

Section	Model		Part no.							
			For AC10-A	For AC20-A	For AC25-A	For AC30-A	For AC40-A	For AC40-06-A		
Option	Round type	Standard	G27-10-R1	—	—	—	—	—	—	—
	Round type (with color zone)	0.02 to 0.2 MPa setting	G27-10-R1 Note 2)	—	—	—	—	—	—	—
Attachment	Spacer	Standard	—	—	—	—	—	—	—	—
	Spacer with bracket	0.02 to 0.2 MPa setting	—	—	—	—	—	—	—	—
Attachment	Check valve	Y100-A	Y200-A	Y300-A	Y400-A	Y500-A	—	—	—	—
	Pressure switch	Y100T-A	Y200T-A	Y300T-A	Y400T-A	Y500T-A	—	—	—	—
	T-spacer	AKM2000-□01-A	AKM3000-□01-A	AKM4000-□02-A	AKM4000-□03-A	—	—	—	—	—
	Pressure relief 3 port valve	IS10M-20-A	IS10M-30-A	IS10M-40-A	IS10M-50-A	—	—	—	—	—
	Piping adapter	Y210-□01-A	Y310-□01-A	Y410-□02-A	Y510-□02-A	—	—	—	—	—
	Pressure relief 3 port valve	Y110-M5-A	Y210-□02-A	Y310-□02-A	Y410-□03-A	Y510-□03-A	—	—	—	—
	Piping adapter	—	VHS20-□01A	VHS30-□02A	VHS40-□03A	VHS40-□06A	—	—	—	—
	Pressure relief 3 port valve	—	□01A	□02A	□03A	□04A	□02A	□03A	□04A	□06A
	Piping adapter	E100-M5-A	E200-□02-A	E300-□03-A	E400-□04-A	E500-□06-A	—	—	—	—
	Pressure switch with piping adapter	—	□01-A	□02-A	□03-A	□04-A	□02-A	□03-A	□04-A	□06-A
Cross spacer	—	IS10E-20□02-A	IS10E-30□03-A	IS10E-40□04-A	IS10E-50□06-A	—	—	—	—	
Cross spacer	Y14-M5-A	Y24-□01-A	Y34-□01-A	Y44-□02-A	Y54-□03-A	—	—	—	—	

Note 1) □ in round pressure gauge part numbers indicates a pipe thread type. No indication is necessary for R; however, indicate N for NPT.  
Please contact SMC regarding the pipe thread type NPT and the supply of pressure gauge with psi unit display specifications.

Note 2) Standard pressure gauge

Note 3) For F.R.L. units, port sizes without ( ) are standard specifications.

Note 4) Separate interfaces are required for modular unit.

## Check Valve: (K) 1/8, 1/4, 3/8

A check valve with intermediate air release port can be easily installed to prevent a backflow of lubricant when redirecting the air flow and releasing the air on the outlet side of the regulator.

AKM 30 00 - 01 - A

Symbol	Description	Body size
1	Body size	20 30 40
2	Pipe thread type	Nil Rc N NPT F G
3	By-pass port size	01 1/8 02 1/4 03 3/8

### Specifications

Model	Effective area (mm <sup>2</sup> )
AKM2000-A	28
AKM3000-A	55
AKM4000-A	111

Be sure to use above check valves when redirecting the air flow on the inlet side of the lubricator. Threads for IN and OUT ports are not machined.

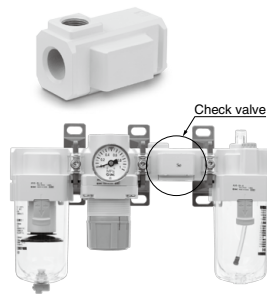
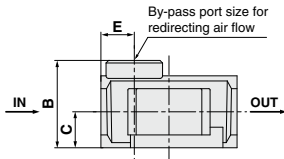
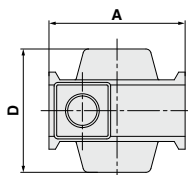
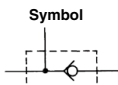

Model	By-pass port size	A	B	C	D	E	Applicable model
AKM2000-A	1/8, 1/4	40	28	11	40	11	AC20-A, AC20A-A
AKM3000-A	1/8, 1/4	53	34	14	48	13	AC25-A, AC30-A, AC30A-A
AKM4000-A	1/4, 3/8	70	42	18	54	15	AC40-A, AC40A-A <sup>(Note)</sup>

Note) Cannot be mounted on the AC40□06-A.

\* Refer to the attachment table above for standard by-pass port sizes applicable to the AC.

# AC Series

## Pressure Switch: (S)

A compact integrated pressure switch can be easily installed and facilitates the pressure detection of the line.

### IS10M-30-  -A

① ②

- Semi-standard: Select one each for a to c.
- Semi-standard symbol: When more than one specification is required, indicate in alphanumeric order.  
Example) IS10M-30-6LP

	Symbol	Description	①				
			Body size				
			20	30	40	50	
② Semi-standard	a	Set pressure range	Nil	●	●	●	●
			6 <sup>Note 1)</sup>	●	●	●	●
	b	Lead wire length	+	●	●	●	●
			Nil	●	●	●	●
L			●	●	●	●	
	Z	●	●	●	●		
c	Pressure unit of the scale plate	+	●	●	●	●	
		Nil	●	●	●	●	
		P <sup>Note 2)</sup>	●	●	●	●	
			MPa	●	●	●	●
			MPa/psi dual scale	●	●	●	●

Note 1) Set pressure range of 6P (L, Z) is 0.2 to 0.6 MPa (30 to 90 psi).

Note 2) This product is for overseas use only according to the new Measurement Law.  
(The SI unit type is provided for use in Japan.)

### Specifications

Fluid	Air
Ambient and fluid temperature	-5 to 60°C (with no freezing)
Proof pressure	1.0 MPa
Maximum operating pressure	0.7 MPa
Set pressure range (when OFF)	0.1 to 0.4 MPa
Hysteresis	0.08 MPa or less

### Switch Characteristics

Contact point configuration	1a
Maximum contact point capacity	2 VA (AC), 2 W (DC)
Operating voltage: AC, DC	100 V or less
Maximum operating current	12 V to 24 VAC, DC: 50 mA 48 VAC, DC: 40 mA 100 VAC, DC: 20 mA

Note) For detailed specifications, refer to the IS10 series in Best Pneumatics No. 8.

## T-Spacer: (T) 1/8, 1/4, 3/8

Using a T-spacer facilitates the branching of air flow.

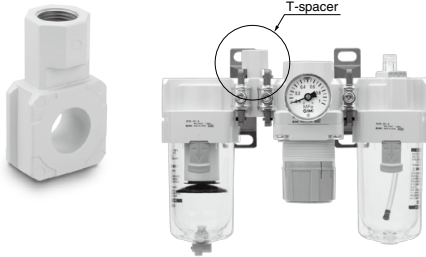

### Caution on Mounting

If a T-spacer is used on the inlet side of the lubricator, lubricant may be mixed. Use the AKM series check valve to avoid such possibility.

Symbol



Pressure switch

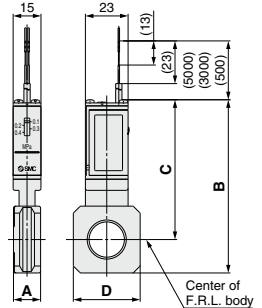

Model	A	B	C	D	Applicable model
IS10M-20-A	10.6	74.2	64.4	28	AC20□-A
IS10M-30-A	12.6	84.5	70.5	30	AC25□-A, AC30□-A
IS10M-40-A	14.6	93.3	75.3	36	AC40□-A
IS10M-50-A	16.6	97.3	77.3	44	AC40□-06-A

\* Separate spacers are required for modular unit.

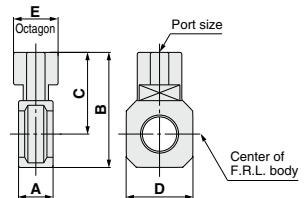

Model <sup>Note)</sup>	Port size	A	B	C	D	E	Applicable model
Y110-M5-A	M5 x 0.8	11.2	19	12	14	8	AC10-A, AC10B-A
Y210-□01-A	1/8	14.6	41.8	32	28	19	AC20-A, AC20B-A
Y210-□02-A	1/4						AC20C-A
Y310-□01-A	1/8	14.6	52.7	38.7	30	19	AC25-A, AC25B-A
Y310-□02-A	1/4						AC25C-A, AC30-A
Y410-□02-A	1/4						AC30B-A, AC30C-A
Y410-□03-A	3/8	18.6	62	44	36	24	AC40-A, AC40B-A
Y510-□02-A	1/4						AC40C-A
Y510-□03-A	3/8	18.6	66	46	44	24	AC40-06-A, AC40B-06-A
							AC40C-06-A

Note) □ in model numbers indicates a pipe thread type. No indication is necessary for Rc; however, indicate N for NPT, and F for G.

\* Separate interfaces are required for modular unit.

\* Refer to the attachment table on page 423 for standard port sizes when using with the AC.

**Pressure Relief 3 Port Valve: (V)** Refer to the [Web Catalog](#) for details on pressure relief 3 port valve

With the use of a pressure relief 3 port valve, pressure left in the line can be easily exhausted.

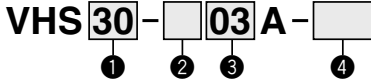

- Semi-standard: Select one each for a to b.
- Semi-standard symbol: When more than one specification is required, indicate in alphanumeric order.  
Example) VHS30-03A-PZ

		Symbol	Description	① Body size			
				20	30	40	
②	Pipe thread type	Nil	Rc	●	●	●	
		N (Note)	NPT	●	●	●	
		F (Note)	G	●	●	●	
+							
③	Port size	01	1/8	●	—	—	
		02	1/4	—	●	●	
		03	3/8	—	—	●	
		04	1/2	—	—	—	
		06	3/4	—	—	●	
+							
④	a	Flow direction	Nil	Flow direction: Left to right	●	●	●
		R	Flow direction: Right to left	●	●	●	
	+						
	b	Pressure unit	Nil	Name plate in imperial units: MPa	●	●	●
Z (Note)			Name plate in imperial units: psi	●	●	●	

Note) For pipe thread type: NPT only. This product is for overseas use only according to the new Measurement Law. (The SI unit type is provided for use in Japan.)

**Symbol**

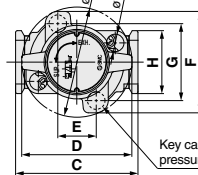
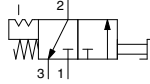

Pressure relief 3 port valve

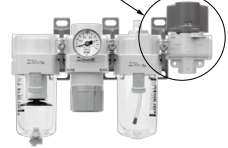

Key can be mounted when residual pressure is released.

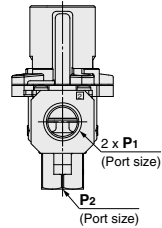
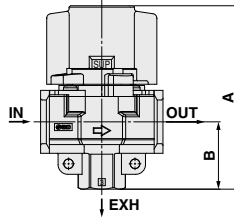

**Specifications**

Model	Port size			Specifications										
	IN, OUT	EXH		IN → OUT			OUT → EXH			b	Cv		b	Cv
				C (dm <sup>3</sup> /s·bar)	b	Cv	C (dm <sup>3</sup> /s·bar)	b	Cv					
VHS20	1/8	1/8		2.4	0.43	0.65	2.5	0.39	0.69					
	1/4	1/4		3.3	0.40	0.88	3.1	0.51	0.84					
VHS30	1/4	1/4		6.4	0.45	1.7	6.2	0.38	1.7					
	3/8	3/8		8.3	0.41	2.3	7.0	0.41	1.9					
VHS40	1/4	1/4		7.3	0.49	2.0	8.5	0.35	2.3					
	3/8	3/8		10.9	0.45	3.0	11.6	0.40	3.1					
	1/2	1/2		14.2	0.39	3.8	13.3	0.43	3.6					
VHS40-06	3/4	1/2		18.3	0.31	5.0	17.7	0.37	4.8					

Note) Use an air filter on the IN side for operating protection.

Model	Standard specifications										
	P1	P2	A	B	C	D	E	F	G	H	I
VHS20	1/8, 1/4	1/8	66.4	22.3	40	37.5	14	46.6	33.6	28	43
VHS30	1/4, 3/8	1/4	80.3	29.4	53	49	19	52	38	30	49
VHS40	1/4, 3/8, 1/2	3/8	104.9	38.5	70	63	22	58	44	36	63
VHS40-06	3/4	1/2	110.4	42	75	63	22	58	44	44	63

**Cross Spacer: 1/8, 1/4, 3/8, 1/2**

Pipings are possible in all 4 directions.  
IN/OUT ports are not machined for threads.  
Please contact SMC if threaded (machined) ports are required.

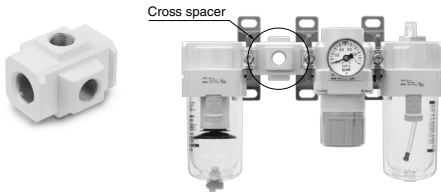

**Caution on Mounting**

1. When mounting a cross spacer directly on the inlet side of the lubricator, be sure to use the AKM series check valve between the lubricator and cross spacer.
2. Factory mounting of a cross spacer on the AC model is available as a special order.

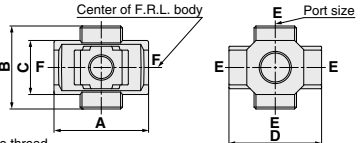

F: Without pipe thread

Model (Note)	E (Port size)	A	B	C	D	Applicable model
Y14-M5-A	M5 x 0.8	23	16	14	25	AC10□-A
Y24-□01-A	1/8	40	40	22	40	AC20□-A
Y24-□02-A	1/4	49	43	28	48	AC25□-A, AC30□-A
Y34-□01-A	1/8	60	48	36	54	AC40□-A
Y34-□02-A	1/4	72	62	40	62	AC40□-06-A
Y44-□02-A	1/4	60	48	36	54	AC40□-A
Y44-□03-A	3/8	60	48	36	54	AC40□-A
Y54-□03-A	3/8	72	62	40	62	AC40□-06-A
Y54-□04-A	1/2	72	62	40	62	AC40□-06-A

- Note) □ in model numbers indicates a pipe thread type. No indication is necessary for Rc; however, indicate N for NPT, and F for G.
- If threaded IN/OUT ports are required, they are available as a special order. Please contact SMC.
  - Two hexagon socket head plugs are included in the package.

# AC Series

## Piping Adapter: 1/8, 1/4, 3/8, 1/2, 3/4

A piping adapter allows installation/removal of the component without removing the piping and thus makes maintenance easier.

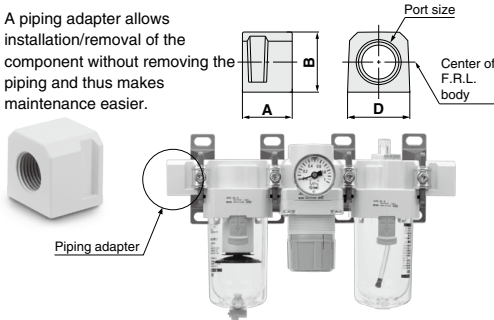

Model (Note)	Port size	A	B	D	Applicable model
E100-M5-A	M5 x 0.8	10	14	14	AC10□-A
E200-□01-A	1/8	29.8	23.5	28	AC20□-A
E200-□02-A	1/4				
E200-□03-A	3/8	31.8	30	30	AC25□-A, AC30□-A
E300-□02-A	1/4				
E300-□03-A	3/8	31.8	36	36	AC40□-A
E400-□02-A	1/4				
E400-□03-A	3/8	31.8	40	44	AC40□-06-A
E400-□04-A	1/2				
E400-□06-A	3/4				

Note 1) □ in model numbers indicates a pipe thread type. No indication is necessary for Rc; however, indicate N for NPT, and F for G.

\* Separate interfaces are required for modular unit.

\* Factory mounting of a piping adapter on the AC models is available as a special order.

## Pressure Switch with Piping Adapter

IS10E-**30**□**03**-□-A

① ② ③ ④

- Semi-standard: Select one each for a to d.
- Semi-standard symbol: When more than one specification is required, indicate in alphanumeric order. Example) IS10E-30N03-6PRZ

	Symbol	Description	①		
			Body size		
			20	30	40
② Pipe thread type	Nil	Rc	●	●	●
	N (Note)	NPT	●	●	●
	F (Note)	G	●	●	●
③ Port size	+		●	●	●
	01	1/8	●	—	—
	02	1/4	●	●	—
	03	3/8	●	●	●
	04	1/2	—	●	●
④ Semi-standard	a	Set pressure range	Nil (Note 1)		0.1 to 0.4 MPa 0.1 to 0.6 MPa
	b	Lead wire length	Nil	0.5 m	
			L	3 m	
			Z	5 m	
	c	Pressure unit of the scale plate	Nil	MPa	
			p (Note 2)	MPa/psi dual scale	
	d	Mounting position	Nil	Right	
			R	Left	

Note 1) Set pressure range of 6P (L, R, Z) is 0.2 to 0.6 MPa (30 to 90 psi).

Note 2) For pipe thread type: NPT only. This product is for overseas use only according to the new Measurement Law. (The SI unit type is provided for use in Japan.)

### Specifications

Fluid	Air
Ambient and fluid temperature	-5 to 60°C (with no freezing)
Proof pressure	1.0 MPa
Maximum operating pressure	0.7 MPa
Set pressure range (when OFF)	0.1 to 0.4 MPa
Hysteresis	0.08 MPa or less

### Switch Characteristics

Contact point configuration	1a
Maximum contact point capacity	2 VA (AC), 2 W (DC)
Operating voltage: AC, DC	100 V or less
Maximum operating current	12 V to 24 V AC, DC: 50 mA
	48 V AC, DC: 40 mA
	100 V AC, DC: 20 mA

### Symbol

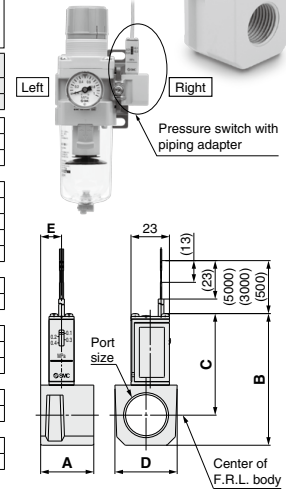

Model (Note 1)	Port size	A	B	C	D	E	Applicable model
IS10E-20□01-A	1/8	29.8	66.3	55.3	28	16	AC20□-A
IS10E-20□02-A	1/4						
IS10E-20□03-A	3/8	31.8	72.8	58.8	30	13	AC25□-A, AC30□-A
IS10E-30□02-A	1/4						
IS10E-30□03-A	3/8	31.8	78.8	60.8	37	12.5	AC40□-A
IS10E-40□02-A	1/4						
IS10E-40□03-A	3/8	31.8	78.8	60.8	37	12.5	AC40□-A
IS10E-40□04-A	1/2						
IS10E-40□06-A	3/4						

Note 1) □ in the model numbers indicates a pipe thread type. No indication is necessary for Rc; however, indicate N for NPT, and F for G.

Note 2) Cannot be mounted on the AC40□-06-A.

\* Separate interfaces are required for modular unit.

\* The pressure switch on the AC40□-06-A can be mounted by screwing IS10-01S into the piping adapter E500-□06-A-X501 (with top-face thread Rc1/8). Products with a pre-mounted switch are available as a special order. Please contact SMC regarding their availability.

# AC Series Accessories (Spacers/Brackets)

## Spacer

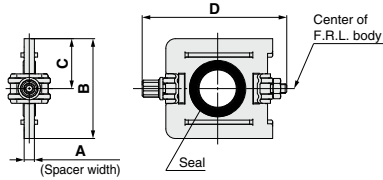

Model	A	B	C	D	Applicable model
Y100-A	6	17.9	9	35.4	AC10□-A
Y200-A	3.2	31.2	15.6	44.9	AC20□-A
Y300-A	4.2	43.4	21.7	57.9	AC25□-A, AC30□-A
Y400-A	5.2	53	26.5	68.5	AC40□-A
Y500-A	5.2	57	28.5	75.6	AC40□-06-A

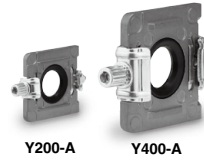

## Replacement Parts

Description	Material	Part no.				
		Y100-A	Y200-A	Y300-A	Y400-A	Y500-A
Seal	HNBR (NBR) <sup>Note 1)</sup>	Y120P-050AS <sup>Note 2)</sup>	Y220P-050S	Y320P-050S	Y420P-050S	Y520P-050S

Note 1) ( ): Size 10

Note 2) Assembly of 2 O-rings

## Spacer with Bracket

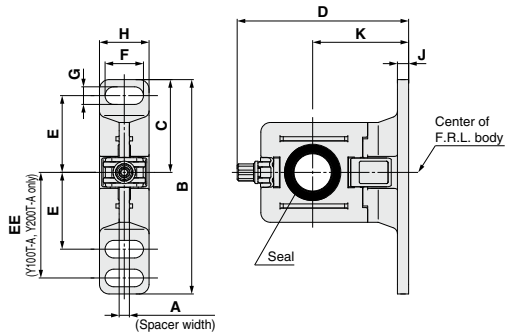

Model	A	B	C	D	E	EE	F	G	H	J	K	Applicable model
Y100T-A	6	56	24.5	43.6	20	27	6.8	4.5	13	3	25	AC10□-A
Y200T-A	3.2	67	29	53.4	24	33	12	5.5	15.5	3.5	30	AC20□-A
Y300T-A	4.2	82	41	71.5	35	—	14	7	19	4	41	AC25□-A, AC30□-A
Y400T-A	5.2	96	48	86.1	40	—	18	9	26	5	50	AC40□-A
Y500T-A	5.2	96	48	89.6	40	—	18	9	26	5	50	AC40□-06-A

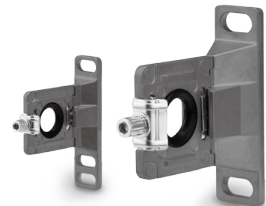

## Replacement Parts

Description	Material	Part no.				
		Y100T-A	Y200T-A	Y300T-A	Y400T-A	Y500T-A
Seal	HNBR (NBR) <sup>Note 1)</sup>	Y120P-050AS <sup>Note 2)</sup>	Y220P-050S	Y320P-050S	Y420P-050S	Y520P-050S

Note 1) ( ): Size 10

Note 2) Assembly of 2 O-rings

AC-A  
AF-A  
AF□-A  
AR-A  
AL-A  
AW-A  
AC-B  
AF-A  
AF□-A  
AR-  
AL-A  
AW-  
AW□  
A□G  
E□  
AV  
AF

## Mounting Position for Spacer with Bracket

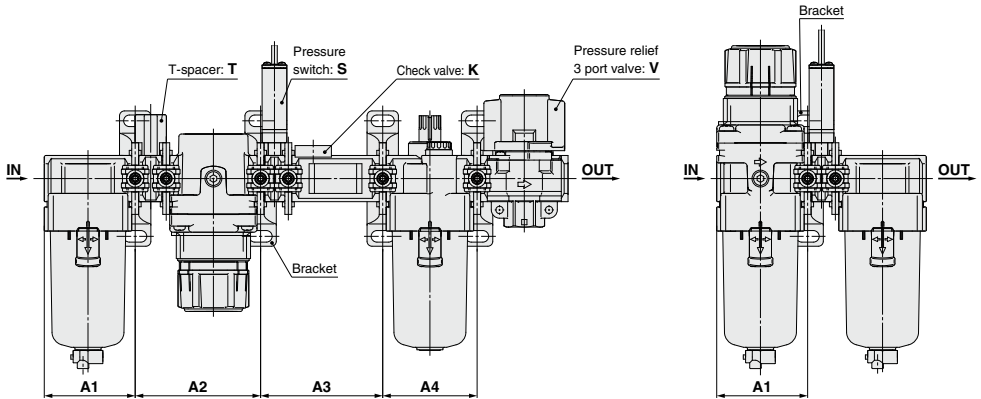

Attachment	K				S				T				V				KS				KT				KV				KST							
	A1	A2	A3	A4	A1	A2	A3	A4	A1	A2	A3	A4	A1	A2	A3	A4	A1	A2	A3	A4	A1	A2	A3	A4	A1	A2	A3	A4	A1	A2	A3	A4				
Model																																				
AC10-A	—				—				28 48.2				—				—				—				—				—				—			
AC20-A	41.6	43.2	43.2	41.6	43.2	41.6	43.2	41.6	61	41.6	43.2	43.2	41.6	43.2	43.2	41.6	57	41.6	61	43.2	41.6	61	43.2	41.6	43.2	41.6	43.2	43.2	41.6	61	57	41.6				
AC25-A	55.1	57.2	57.2	55.1	57.2	55.1	57.2	55.1	76	55.1	57.2	57.2	55.1	57.2	57.2	55.1	74	55.1	76	57.2	55.1	76	57.2	55.1	57.2	55.1	57.2	57.2	55.1	76	74	55.1				
AC30-A	55.1	57.2	57.2	55.1	57.2	55.1	57.2	55.1	76	55.1	57.2	57.2	55.1	57.2	57.2	55.1	74	55.1	76	57.2	55.1	76	57.2	55.1	57.2	55.1	57.2	57.2	55.1	76	74	55.1				
AC40-A	72.6	75.2	75.2	72.6	75.2	72.6	75.2	72.6	99	72.6	75.2	75.2	72.6	75.2	75.2	72.6	95	72.6	99	75.2	72.6	99	75.2	72.6	75.2	72.6	75.2	75.2	72.6	99	95	72.6				
AC40-06-A	—				77.6				104				77.6				80.2				—				—				—							

Attachment	KSV				KTV				KSTV				ST		SV			STV			TV											
	A1	A2	A3	A4	A1	A2	A3	A4	A1	A2	A3	A4	A1	A2	A1	A2	A3	A1	A2	A3	A1	A2	A3									
Model																																
AC10-A	—				—				—				—		—			—			—											
AC20-A	41.6	43.2	57	43.2	41.6	61	43.2	43.2	41.6	61	57	43.2	41.6	61	41.6	43.2	57	41.6	61	57	41.6	61	57	41.6	61	43.2						
AC25-A	55.1	57.2	74	57.2	55.1	76	57.2	57.2	55.1	76	74	57.2	55.1	76	55.1	57.2	74	55.1	76	74	55.1	76	74	55.1	76	57.2						
AC30-A	55.1	57.2	74	57.2	55.1	76	57.2	57.2	55.1	76	74	57.2	55.1	76	55.1	57.2	74	55.1	76	74	55.1	76	74	55.1	76	57.2						
AC40-A	72.6	75.2	95	75.2	72.6	99	75.2	75.2	72.6	99	95	75.2	72.6	99	72.6	99	72.6	75.2	95	72.6	75.2	95	72.6	75.2	95	75.2						
AC40-06-A	—				—				—				77.6		104			80.2			102			77.6			104			80.2		

Attachment	K		S		V		KS		KV			KSV			SV	
	A1	A2	A1	A2	A1	A2	A1	A2	A1	A2	A3	A1	A2	A3	A1	A2
Model																
AC10A-A	—		—		—		—		—			—			—	
AC20A-A	41.6	43.2	41.6	41.6	43.2	41.6	57	41.6	43.2	43.2	41.6	57	43.2	41.6	57	
AC30A-A	55.1	57.2	55.1	55.1	57.2	55.1	74	55.1	57.2	57.2	55.1	74	57.2	55.1	74	
AC40A-A	72.6	75.2	72.6	72.6	75.2	72.6	95	72.6	75.2	75.2	72.6	95	75.2	72.6	95	
AC40A-06-A	—		77.6		80.2		—		—			77.6			102	

Attachment	S		T		V		SV		SV1		TV		TV1	
	A1	A2	A1	A2	A1	A2	A1	A2	A1	A2	A1	A2	A1	A2
Model														
AC10B-A	28		—		—		—		—		—		—	
AC20B-A	41.6	41.6	41.6	43.2	41.6	43.2	41.6	57	41.6	43.2	41.6	61	41.6	43.2
AC25B-A	55.1	55.1	55.1	57.2	55.1	57.2	55.1	74	55.1	57.2	55.1	76	55.1	57.2
AC30B-A	55.1	55.1	55.1	57.2	55.1	57.2	55.1	74	55.1	57.2	55.1	76	55.1	57.2
AC40B-A	72.6	72.6	72.6	75.2	72.6	75.2	72.6	95	72.6	75.2	72.6	99	72.6	75.2
AC40B-06-A	77.6	77.6	77.6	80.2	77.6	80.2	77.6	102	77.6	80.2	77.6	104	77.6	80.2

Attachment	S		T		V			V1			SV			SV1			TV			TV1				
	A1	A2	A1	A2	A1	A2	A3	A1	A2	A3	A1	A2	A3	A1	A2	A3	A1	A2	A3	A1	A2	A3		
Model																								
AC20C-A	41.6	43.2	41.6	43.2	41.6	43.2	43.2	41.6	43.2	43.2	41.6	43.2	57	41.6	43.2	43.2	41.6	43.2	61	41.6	43.2	43.2		
AC25C-A	55.1	57.2	55.1	57.2	55.1	57.2	55.1	57.2	55.1	57.2	57.2	55.1	74	55.1	57.2	57.2	55.1	57.2	76	55.1	57.2	57.2		
AC30C-A	55.1	57.2	55.1	57.2	55.1	57.2	55.1	57.2	55.1	57.2	57.2	55.1	74	55.1	57.2	57.2	55.1	57.2	76	55.1	57.2	57.2		
AC40C-A	72.6	75.2	72.6	75.2	72.6	75.2	72.6	75.2	72.6	75.2	75.2	72.6	95	72.6	75.2	75.2	72.6	75.2	99	72.6	75.2	75.2		
AC40C-06-A	77.6	80.2	77.6	80.2	77.6	80.2	77.6	80.2	77.6	80.2	80.2	77.6	80.2	102	77.6	80.2	80.2	77.6	80.2	104	77.6	80.2		

Attachment	S		V		V1		SV		SV1	
	A1	A2	A1	A2	A1	A2	A1	A2	A1	A2
Model										
AC20D-A	41.6	41.6	43.2	41.6	43.2	41.6	57	41.6	43.2	43.2
AC30D-A	55.1	55.1	57.2	55.1	57.2	55.1	74	55.1	57.2	57.2
AC40D-A	72.6	72.6	75.2	72.6	75.2	72.6	95	72.6	75.2	75.2
AC40D-06-A	77.6	77.6	80.2	77.6	80.2	77.6	102	77.6	80.2	80.2

A1: Dimension from the end of the IN side to the center of the mounting hole for the first bracket.



A2: Mounting hole pitch between the first and the second brackets.

A3: Mounting hole pitch between the second and the third brackets.

A4: Mounting hole pitch between the third and the fourth brackets.

# Modular Type Air Filters

# AF/AFM/AFD Series

Air Filter AF Series	Model	Port size	Filtration μm	Options
 <p>P.430 to 438</p>	AF10-A	M5 x 0.8	5	Bracket (Except AF10-A)  Float type auto drain
	AF20-A	1/8, 1/4		
	AF30-A	1/4, 3/8		
	AF40-A	1/4, 3/8, 1/2		
	AF40-06-A	3/4		
	AF50-A	3/4, 1		
	AF60-A	1		
 <p>P.440 to 447</p>	AFM20-A	1/8, 1/4	0.3	Bracket  Float type auto drain
	AFM30-A	1/4, 3/8		
	AFM40-A	1/4, 3/8, 1/2		
	AFM40-06-A	3/4		
 <p>P.440 to 447</p>	AFD20-A	1/8, 1/4	0.01	Bracket  Float type auto drain
	AFD30-A	1/4, 3/8		
	AFD40-A	1/4, 3/8, 1/2		
	AFD40-06-A	3/4		

## Made to Order

①	<b>Long Bowl (-X64)</b> Drain capacity is greater than that of standard models.	<b>AF: P.437 to 439-1</b>  <b>AFM/AFD: P.446, 448</b>
②	<b>With Element Service Indicator (-X2141)</b> Clogging status of elements can be checked visually.	
③	<b>Special Temperature Environment (-X430/-X440)</b> Special materials are used in the manufacturing of seals and resin parts to allow them to withstand various temperature conditions in cold or tropical (hot) climates.	
④	<b>High Pressure (-X425)</b> Strong materials are used in the manufacturing of air filters intended for high pressure operation.	
⑤	<b>Clean Series (10-)</b>	
⑥	<b>Copper, Fluorine and Silicone-free + Low Particle Generation (21-)</b>	

AC-A
AF-A
AF□-A
AR-A
AL-A
AW-A
AC-B
AF-A
AF□-A
AR- <input checked="" type="checkbox"/>
AL-A
AW- <input checked="" type="checkbox"/>
AW□
A□G
E□
AV
AF

# Air Filter

# AF10-A to AF60-A

Symbol  
Air Filter

Air Filter with Auto Drain

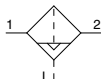
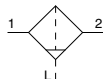

AF10-A



AF20-A



AF40-A

## How to Order

AF **30** - **03** **BD** - **A** - **Made to Order**

① ② ③ ④ ⑤

- Option/Semi-standard: Select one each for a to f.
- Option/Semi-standard symbol: When more than one specification is required, indicate in alphanumeric order.  
Example) AF30-03BD-R-A

(Refer to pages 437 and 438 for details.)

	Symbol	Description	① Body size					
			10	20	30	40	50	60
② Pipe thread type	Nil	Metric thread (M5)	●	—	—	—	—	—
	N <sup>Note 1)</sup>	Rc	—	●	—	—	—	—
	F <sup>Note 2)</sup>	NPT	—	●	●	●	●	●
		G	—	●	●	●	●	●
③ Port size	+	M5	●	—	—	—	—	—
		01	—	●	—	—	—	—
		02	—	●	●	—	—	—
		03	—	—	●	●	—	—
		04	—	—	—	●	●	—
		06	—	—	—	●	●	—
		10	1	—	—	—	●	●
④ Option	a Mounting	Nil Without mounting option B <sup>Note 3)</sup> With bracket	●	●	●	●	●	●
	b Float type auto drain	Nil Without auto drain C <sup>Note 4)</sup> N.C. (Normally closed) Drain port is closed when pressure is not applied. D <sup>Note 5)</sup> N.O. (Normally open) Drain port is open when pressure is not applied.	●	●	●	●	●	●
⑤ Semi-standard	c Bowl <sup>Note 6)</sup>	Nil Polycarbonate bowl	●	●	●	●	●	●
		2 Metal bowl	●	●	—	—	●	●
		6 Nylon bowl	●	●	●	●	●	●
		8 Metal bowl with level gauge	—	—	—	●	●	—
		C With bowl guard	—	●	—	—	—	—
	6C With bowl guard (Nylon bowl)	—	●	—	—	—	—	
d Drain port <sup>Note 9)</sup>	Nil With drain cock	●	●	●	●	●	●	
	J <sup>Note 10)</sup> Drain guide 1/8 Drain guide 1/4	—	—	—	—	—	—	
	W <sup>Note 11)</sup> Drain cock with barb fitting	—	—	●	●	●	●	
e Flow direction	Nil Flow direction: Left to right	●	●	●	●	●	●	
	R Flow direction: Right to left	●	●	●	●	●	●	
f Pressure unit	Nil Name plate and caution plate for bowl in imperial units: MPa	●	●	●	●	●	●	
	Z <sup>Note 12)</sup> Name plate and caution plate for bowl in imperial units: psi, °F	○ <sup>Note 13)</sup>	○ <sup>Note 13)</sup>	○ <sup>Note 13)</sup>	○ <sup>Note 13)</sup>	○ <sup>Note 13)</sup>	○ <sup>Note 13)</sup>	

Note 1) Drain guide is NPT1/8 (applicable to the AF20-A) and NPT1/4 (applicable to the AF30-A to AF60-A).

The auto drain port comes with ø3/8" One-touch fitting (applicable to the AF30-A to AF60-A).

Note 2) Drain guide is G1/8 (applicable to the AF20-A) and G1/4 (applicable to the AF30-A to AF60-A).

The auto drain port comes with ø10 One-touch fitting (applicable to the AF30-A to AF60-A).

Note 3) Option B is not assembled and supplied loose at the time of shipment. Assembly of a bracket and 2 mounting screws.

Note 4) When pressure is not applied, condensate which does not start the auto drain mechanism will be left in the bowl.

Releasing the residual condensate before ending operations for the day is recommended.

Note 5) If the compressor is small (0.75 kW, discharge flow is less than 100 L/min [ANR]), air leakage from the drain cock may occur during start of operations. N.C. type is recommended.

Note 6) Refer to Chemical data on page 433 for chemical resistance of the bowl.

Note 7) A bowl guard is provided as standard equipment (polycarbonate).

Note 8) A bowl guard is provided as standard equipment (nylon).

Note 9) The combination of float type auto drain: C and D is not available.

Note 10) Without a valve function

Note 11) The combination of metal bowl: 2 and 8 is not available.

Note 12) For pipe thread type: M5, NPT. This product is for overseas use only according to the new Measurement Law. (The SI unit type is provided for use in Japan.)

Note 13) ○: For pipe thread type: M5, NPT only



## Standard Specifications

Model	AF10-A	AF20-A	AF30-A	AF40-A	AF40-06-A	AF50-A	AF60-A
<b>Port size</b>	M5 x 0.8	1/8, 1/4	1/4, 3/8	1/4, 3/8, 1/2	3/4	3/4, 1	1
<b>Fluid</b>	Air						
<b>Ambient and fluid temperature</b>	-5 to 60 °C (with no freezing)						
<b>Proof pressure</b>	1.5 MPa						
<b>Maximum operating pressure</b>	1.0 MPa						
<b>Nominal filtration rating</b>	5 μm						
<b>Drain capacity (cm<sup>3</sup>)</b>	2.5	8	25			45	
<b>Bowl material</b>	Polycarbonate						
<b>Bowl guard</b>	—	Semi-standard (Steel)		Standard (Polycarbonate)			
<b>Weight (kg)</b>	0.06	0.08	0.18	0.36	0.41	0.87	1.00

## Options/Part No.

Optional specifications	Model						
	AF10-A	AF20-A	AF30-A	AF40-A	AF40-06-A	AF50-A	AF60-A
<b>Bracket assembly</b> <sup>Note)</sup>	—	AF22P-050AS	AF32P-050AS	AF42P-050AS	AF42P-070AS	AF52P-050AS	

Note) Assembly of a bracket and 2 mounting screws

## Bowl Assembly/Part No.

Bowl material	Drain discharge mechanism	Drain port	Other	Model						
				AF10-A	AF20-A	AF30-A	AF40-A	AF40-06-A	AF50-A	AF60-A
Polycarbonate bowl	Manual discharge	With drain cock	—	C1SF-A	C2SF-A	—	—			
			With bowl guard	—	C2SF-C-A	C3SF-A	C4SF-A			
		Drain cock with barb fitting	With bowl guard	—	C3SF-W-A		C4SF-W-A			
	Automatic discharge <sup>Note)</sup> (Auto drain)	Normally closed (N.C.)	With drain guide (without valve function)	—	C2SF□-J-A	—	—			
			With bowl guard	—	C2SF□-CJ-A	C3SF□-J-A	C4SF□-J-A			
		Normally open (N.O.)	With bowl guard	—	AD17-A	AD27-A	—			
Nylon bowl	Manual discharge	With drain cock	—	C1SF-6-A	C2SF-6-A	—	—			
			With bowl guard	—	C2SF-6C-A	C3SF-6-A	C4SF-6-A			
		Drain cock with barb fitting	With bowl guard	—	C3SF-6W-A		C4SF-6W-A			
	Automatic discharge <sup>Note)</sup> (Auto drain)	Normally closed (N.C.)	With drain guide (without valve function)	—	C2SF□-6J-A	—	—			
			With bowl guard	—	C2SF□-6CJ-A	C3SF□-6J-A	C4SF□-6J-A			
		Normally open (N.O.)	With bowl guard	—	AD17-6-A	AD27-6-A	—			
Metal bowl	Manual discharge	With drain cock	—	C1SF-2-A	C2SF-2-A	C3SF-2-A	C4SF-2-A			
			With level gauge	—	—	C3LF-8-A	C4LF-8-A			
		With drain guide (without valve function)	With level gauge	—	C2SF□-2J-A	C3SF□-2J-A	C4SF□-2J-A			
	Automatic discharge <sup>Note)</sup> (Auto drain)	Normally closed (N.C.)	—	AD17-2-A	AD27-2-A	AD37□-2-A	AD47□-2-A			
			With level gauge	—	—	AD37□-8-A	AD47□-8-A			
		Normally open (N.O.)	With level gauge	—	—	AD38□-2-A	AD48□-2-A			
			With level gauge	—	—	AD38□-8-A	AD48□-8-A			

Note) Minimum operating pressure: N.O. type—0.1 MPa (AD38-A, AD48-A); N.C. type—0.1 MPa (AD17-A, AD27-A) and 0.15 MPa (AD37-A, AD47-A).

Bowl assembly for the AF20-A to AF60-A models comes with a bowl seal.

□ in bowl assembly part numbers indicates a pipe thread type (applicable tubing for auto drain).

No indication is necessary for Rc thread; however, indicate N for NPT thread, and F for G thread. (For auto drain, Nil: ϕ10, N: ϕ3/8")

Please consult with SMC separately for psi and °F unit display specifications.

# AF10-A to AF60-A Series

## Flow Rate Characteristics (Representative values)

**AF10-A**

M5

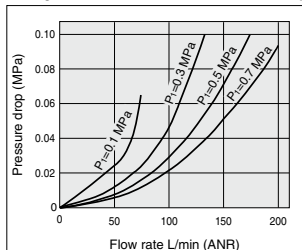

**AF20-A**

Rc1/4

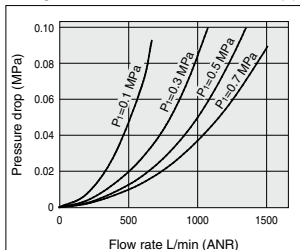

**AF30-A**

Rc3/8

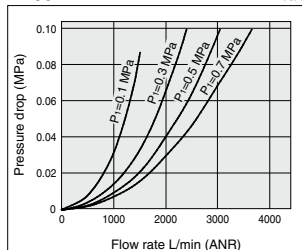

**AF40-A**

Rc1/2

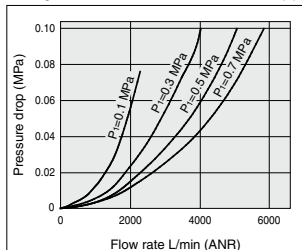

**AF40-06-A**

Rc3/4

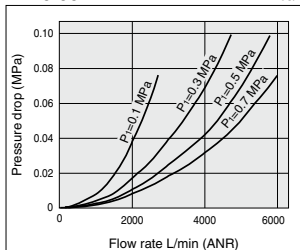

**AF50-A**

Rc1

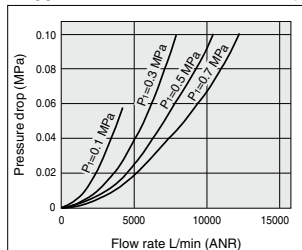

**AF60-A**

Rc1

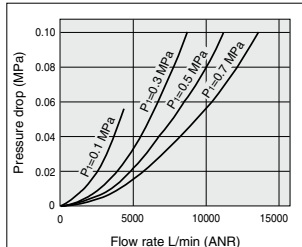

## ⚠ Specific Product Precautions

Be sure to read this before handling the products. Refer to back page 50 for Safety Instructions and pages 387 to 391 for F.R.L. Precautions.

### Design/Selection

#### ⚠ Warning

- The standard bowl for the air filter, filter regulator, and lubricator, as well as the sight dome for the lubricator are made of polycarbonate. Do not use in an environment where they are exposed to or come in contact with organic solvents, chemicals, cutting oil, synthetic oil, alkali, and thread lock solutions.

**Effects of atmosphere of organic solvents and chemicals, and where these elements are likely to adhere to the equipment.**

**Chemical data for substances causing degradation (Reference)**

Type	Chemical name	Application examples	Material	
			Polycarbonate	Nylon
Acid	Hydrochloric acid Sulfuric acid, Phosphoric acid Chromic acid	Acid washing liquid for metals	△	×
Alkaline	Sodium hydroxide (Caustic soda) Potash Calcium hydroxide (Slack lime) Ammonia water Carbonate of soda	Degreasing of metals Industrial salts Water-soluble cutting oil	×	○
Inorganic salts	Sodium sulfide Sulfate of potash Sulfate of soda	—	×	△
Chlorine solvents	Carbon tetrachloride Chloroform Ethylene chloride Methylene chloride	Cleansing liquid for metals Printing ink Dilution	×	△
Aromatic series	Benzene Toluene Paint thinner	Coatings Dry cleaning	×	△
Ketone	Acetone Methyl ethyl ketone Cyclohexane	Photographic film Dry cleaning Textile industries	×	×
Alcohol	Ethyl alcohol IPA Methyl alcohol	Antifreeze Adhesives	△	×
Oil	Gasoline Kerosene	—	×	○
Ester	Phthalic acid dimethyl Phthalic acid diethyl Acetic acid	Synthetic oil Anti-rust additives	×	○
Ether	Methyl ether Ethyl ether	Brake oil additives	×	○
Amino	Methyl amino	Cutting oil Brake oil additives Rubber accelerator	×	×
Others	Thread-lock fluid Seawater Leak tester	—	×	△

○: Essentially safe    △: Some effects may occur.    ×: Effects will occur.

When the above factors are present, or there is some doubt, use a metal bowl for safety.

### Maintenance

#### ⚠ Warning

- Replace the element every 2 years or when the pressure drop becomes 0.1 MPa, whichever comes first, to prevent damage to the element.

### Mounting/Adjustment

#### ⚠ Caution

- When the bowl is installed on the air filter (AF30-A to AF60-A), install them so that the lock button lines up to the groove of the front (or the back) of the body to avoid drop or damage of the bowl.



- AC-A
- AF-A**
- AF-A
- AR-A
- AL-A
- AW-A
- AC-B
- AF-A
- AF-A
- AR-A
- AL-A
- AW-A
- AW
- AW
- AG
- E
- AV
- AF

# AF10-A to AF60-A Series

## Working Principle: Float Type Auto Drain

### N.O. type: AD38-A, AD48-A

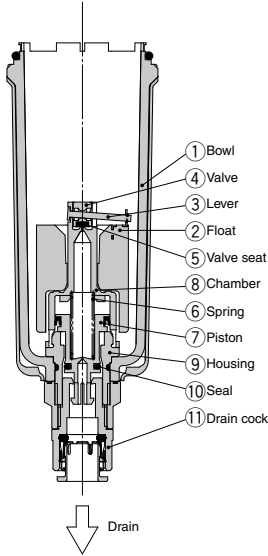

**• When pressure inside the bowl is released:**

When pressure is released from the bowl ①, the piston ⑦ is lowered by the spring ⑥. The sealing action of the seal ⑩ is interrupted, and the outside air flows inside the bowl ① through the housing hole ⑨ and the drain cock ⑪.

Therefore, if there is an accumulation of condensate in the bowl ①, it will drain out through the drain cock.

**• When pressure is applied inside the bowl:**

When pressure is 0.1 MPa or more, the force of the piston ⑦ surpasses the force of the spring ⑥, and the piston goes up.

This pushes the seal ⑩ up so that it creates a seal, and the inside of the bowl ①, is shut off from the outside air.

If there is no accumulation of condensate in the bowl ① at this time, the float ② will be pulled down by its own weight, causing the valve ④, which is connected to the lever ③, to seal the valve seat ⑤.

**• When there is an accumulation of condensate in the bowl:**

The float ② rises due to its own buoyancy and the seal at the valve seat ⑤ is interrupted.

This allows the pressure inside the bowl ① to enter the chamber ⑧. The result is that the combined pressure inside the chamber ⑧ and the force of the spring ⑥ lowers the piston ⑦.

This causes the sealing action of the seal ⑩ to be interrupted, and the accumulated condensate in the bowl ① drains out through the drain cock ⑪.

Turning the drain cock ⑪ manually counterclockwise lowers the piston ⑦, and causes the seal created by the seal ⑩ to be interrupted, thus allowing the condensate to drain out.

### N.C. type: AD37-A, AD47-A

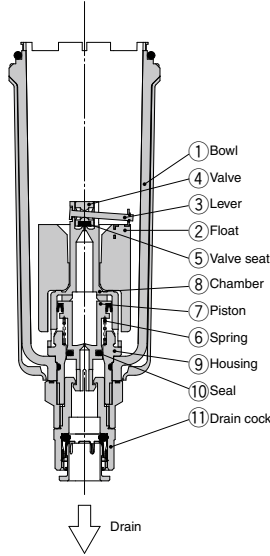

**• When pressure inside the bowl is released:**

Even when pressure inside the bowl ① is released, spring ⑥ keeps the piston ⑦ in its upward position.

This keeps the seal created by the seal ⑩ in place; thus, the inside of the bowl ① is shut off from the outside air.

Therefore, even if there is an accumulation of condensate in the bowl ①, it will not drain out.

**• When pressure is applied inside the bowl:**

Even when pressure is applied inside the bowl ①, the combined force of the spring ⑥ and the pressure inside the bowl ① keeps the piston ⑦ in its upward position.

This maintains the seal created by the seal ⑩ in place; thus, the inside of the bowl ① is shut off from the outside air.

If there is no accumulation of condensate in the bowl ① at this time, the float ② will be pulled down by its own weight, causing the valve ④, which is connected to the lever ③, to seal the valve seat ⑤.

**• When there is an accumulation of condensate in the bowl:**

The float ② rises due to its own buoyancy and the seal at the valve seat ⑤ is interrupted. This allows the pressure inside the bowl ① to enter the chamber ⑧.

The result is that the pressure inside the chamber ⑧ surpasses the force of the spring ⑥ and pushes the piston ⑦ downward.

This causes the sealing action of the seal ⑩ to be interrupted and the accumulated condensate in the bowl ① drains out through the drain cock ⑪.

Turning the drain cock ⑪ manually counterclockwise lowers the piston ⑦, and causes the seal created by the seal ⑩ to be interrupted, thus allowing the condensate to drain out.

### Compact auto drain N.C. type: AD17-A, AD27-A

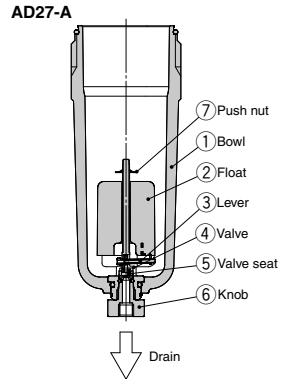
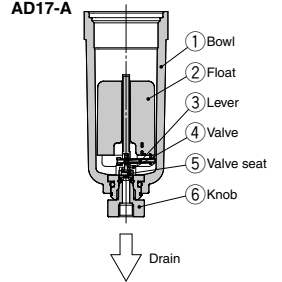

**• When pressure inside the bowl is released:**

When pressure inside the bowl ① is released, the weight of the float ② causes the valve ④, which is connected to the lever ③, to seal the valve seat ⑤. As a result, the inside of the bowl ① is shut off from the outside air.

Therefore, even if there is an accumulation of condensate in the bowl ①, it will not drain out.

**• When pressure is applied inside the bowl:**

Even when pressure is applied inside the bowl ①, the weight of the float ② and the differential pressure that is applied to the valve ④ cause the valve ④ to seal the valve seat ⑤, and the outside air is shut off from the inside of the bowl ①.

**• When there is an accumulation of condensate in the bowl:**

The float ② rises due to its own buoyancy and the seal at the valve seat ⑤ is interrupted.

The condensate inside the bowl ① drains out through the knob ⑥.

Turning the knob ⑥ manually counterclockwise lowers it and causes the sealing action of the valve seat ⑤ to be interrupted, which allows the condensate to drain out.

## Operating State and Proper Use of Float Type Auto Drain

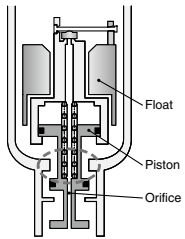
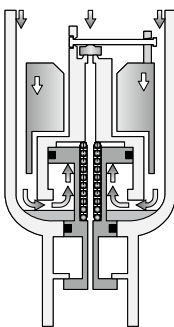
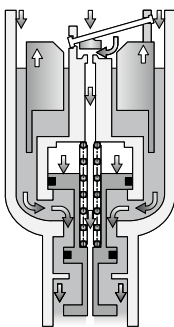
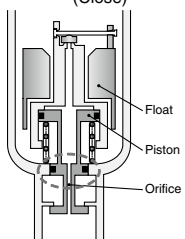
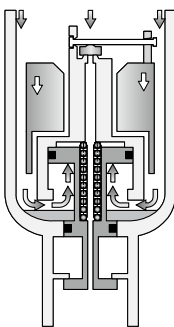
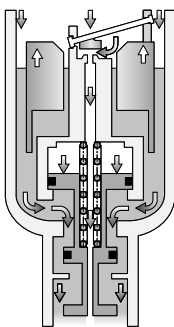
Auto drain	When pressure is not applied (After exhausting residual pressure)	When pressure is applied		Minimum operating pressure (Outlet pressure)
		Before drain accumulates	When drain accumulates	
N.O. Normally open	Drain discharged (Open) 	Drain not discharged (Close) 	Drain discharged (Open) 	<b>0.1 MPa or more</b> AF30-A to AF60-A
N.C. Normally closed	Drain not discharged (Close) 			<b>0.1 MPa or more</b> AF10-A to AF20-A <b>0.15 MPa or more</b> AF30-A to AF60-A

◆ For both N.O. and N.C., the drain can be discharged manually by turning the drain cock to the "O" position.

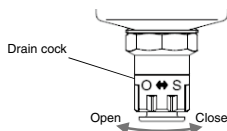

AC-A

AF-A

AF-A

AR-A

AL-A

AW-A

AC-B

AF-A

AF-A

AR-B

AL-A

AW-B

AW

AW

AC-G

E

AV

AF

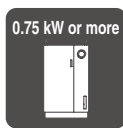
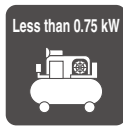
Proper Use			Recommended auto drain
Compressor	When pressure is not applied (After exhausting residual pressure)	Cold climates	
<b>0.75 kW or more</b> 	<b>Drain not accumulated</b> Do not want to accumulate drain generated at the inlet side when pressure is not applied.	<b>Want to prevent troubles caused by freezing.</b>	N.O.*1 Normally open
<b>Less than 0.75 kW</b> 	<b>Drain accumulated</b>	—	N.C. Normally closed

\*1 For N.O. (Normally open) type, the drain discharge passage is open when pressure is not applied. For this reason, the drain exhaust port is not closed completely in a compressor with a small supply amount (less than 0.75 kW) and the air will ceaselessly blow out.



## Construction

**AF10-A/AF20-A**

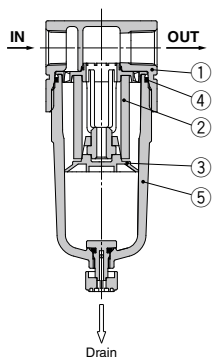

**AF30-A to AF40-06-A**

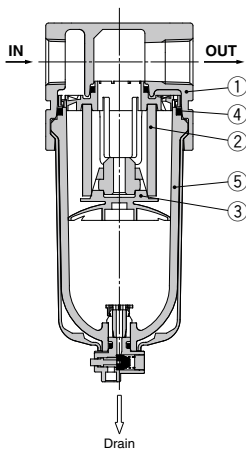

**AF50-A/AF60-A**

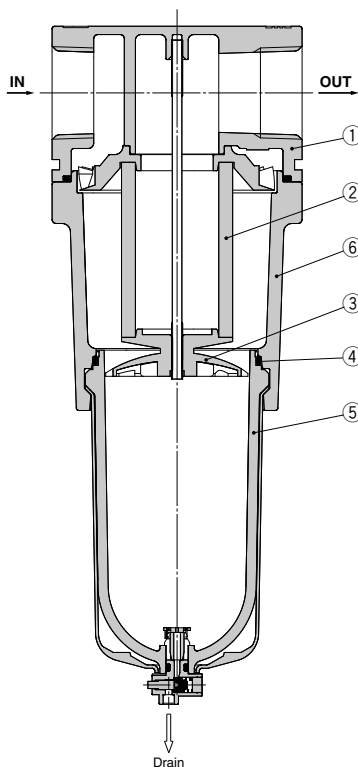

AC-A
<b>AF-A</b>
AF□-A
AR-A
AL-A
AW-A
AC-B
AF-A
AF□-A
AR- <del>A</del>
AL-A
AW- <del>A</del>
AW□
A□G
E□
AV
AF

### Component Parts

No.	Description	Material	Model	Color
1	Body	Zinc die-cast	AF10-A	White
		Aluminum die-cast	AF20-A to AF60-A	
6	Housing	Aluminum die-cast	AF50-A/AF60-A	White

### Replacement Parts

No.	Description	Material	Part no.						
			AF10-A	AF20-A	AF30-A	AF40-A	AF40-06-A	AF50-A	AF60-A
2	Filter element	Non-woven fabric	AF10P-060S	AF20P-060S	AF30P-060S	AF40P-060S	AF40P-060S	AF50P-060S	AF60P-060S
3	Baffle	PBT	AF10P-040S <sup>Note 2)</sup>	AF22FP-040S	AF32P-040S	AF42P-040S	AF42P-040S	AF50P-040S	AF60P-040S
4	Bowl seal	NBR	C1SFP-260S	C2SFP-260S	C32FP-260S	C42FP-260S			
5	Bowl assembly <sup>Note 1)</sup>	Polycarbonate	C1SF-A	C2SF-A	C3SF-A	C4SF-A			

Note 1) Bowl seal is included for the AF20-A to AF60-A. Please contact SMC regarding the supply of bowl assembly with psi and "F unit display specifications.  
 Note 2) The baffle material for the AF10-A (AF10P-040S) only is polyacetal.

# AF10-A to AF60-A Series

## Dimensions

### AF10-A/AF20-A

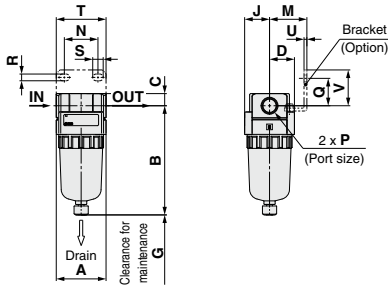

### AF50-A/AF60-A

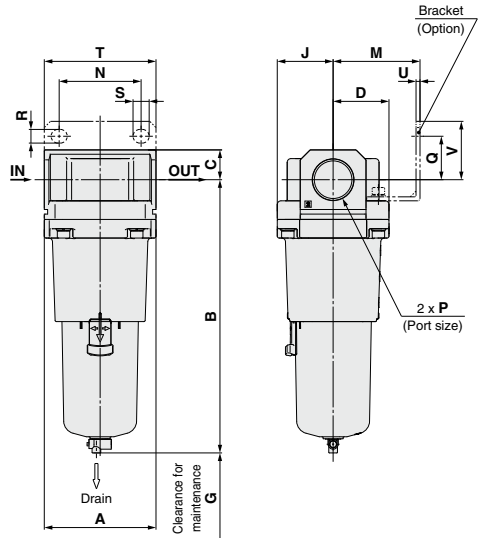

### AF30-A to AF40-06-A

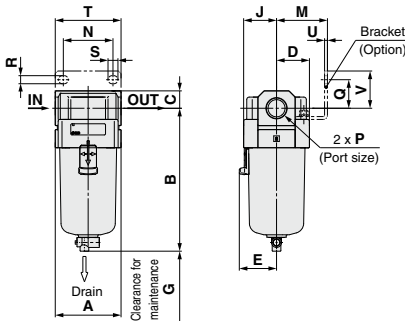

Applicable model	AF10-A/AF20-A		AF20-A		AF30-A to AF60-A
Optional/Semi-standard specifications	With auto drain (N.C.)	Metal bowl	With drain guide	Metal bowl with drain guide	With auto drain (N.O./N.C.)
Dimensions	M5 x 0.8		Width across flats 14 1/8	Width across flats 14 1/8	N.O.: Black N.C.: Gray Thread type/Rc, G: ø10 One-touch fitting Thread type/NPT: ø3/8" One-touch fitting

Applicable model	AF30-A to AF60-A					
Optional/Semi-standard specifications	Metal bowl	Metal bowl with drain guide	Metal bowl with level gauge	Metal bowl with level gauge, with drain guide	With drain guide	Drain cock with barb fitting
Dimensions		Width across flats 17 1/4		Width across flats 17 1/4	Width across flats 17 1/4	Barb fitting applicable tubing: T0604

Model	Standard specifications													Optional specifications						Semi-standard specifications					
	P	A	B	C	D	E	G	J	M	N	Q	R	S	T	U	V	B	B	B	B	B	B	B		
AF10-A	M5 x 0.8	25	59.9	7	12.5	—	25	12.5	—	—	—	—	—	—	—	—	77.9	—	—	—	59.3	—	—		
AF20-A	1/8, 3/8	40	87.6	9.8	20	—	25	20	30	27	22	5.4	8.4	4.0	2.3	28	104.9	—	—	91.4	87.4	93.9	—		
AF30-A	1/4, 3/8	53	115.1	14	26.7	30	35	26.7	41	35	23	6.5	13	5.3	2.3	30	156.8	123.6	121.9	117.6	122.1	137.6	142.1		
AF40-A	1/4, 3/8, 1/2	70	147.1	18	35.5	38.4	40	35.5	50	52	26	8.5	12.5	7.0	2.3	35	186.9	155.6	153.9	149.6	154.1	169.6	174.1		
AF40-06-A	3/4	75	149.1	20	35.5	38.4	40	35.5	50	52	25	8.5	12.5	7.0	2.3	34	188.9	157.6	155.9	151.6	156.1	171.6	176.1		
AF50-A	3/4, 1	90	220.1	24	45	—	30	45	70	66	35	11	13	9.0	3.2	47	259.9	228.6	226.9	222.6	227.1	242.6	247.1		
AF60-A	1	95	234.1	24	47.5	—	30	47.5	70	66	35	11	13	9.0	3.2	47	273.9	242.6	240.9	236.6	241.1	256.6	261.1		



# Air Filter/AF20-A to AF40-06-A

## Made to Order

Please contact SMC for detailed dimensions, specifications and lead times.



### ① Long Bowl

Drain capacity is greater than that of standard models.

#### Applicable Model/Drain Capacity

Model	AF20-A	AF30-A	AF40-A	AF40-06-A
Port size	1/8, 1/4	1/4, 3/8	1/4, 3/8, 1/2	3/4
Drain capacity (cm <sup>3</sup> )	19	43	88	
B dimension (mm) <small>Note 1</small>	108.6	137.1	167.2	169.2

Note) For polycarbonate bowls. Please contact SMC for other bowl materials.

AF 30 - 03 03 - 03 - A - X64

1   
 2   
 3   
 4   
 5

• Long bowl

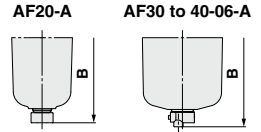

- Semi-standard: Select one each for a to d.
  - Option/Semi-standard symbol: When more than one specification is required, indicate in alphanumeric order.
- Example) AF30-03B-2R-A-X64

		Symbol	Description	① Body size			
				20	30	40	
②	Pipe thread type	Nil	Rc	●	●	●	
		N <small>Note 1</small>	NPT	●	●	●	
		F <small>Note 2</small>	G	●	●	●	
+							
③	Port size	01	1/8	●	—	—	
		02	1/4	●	●	●	
		03	3/8	—	●	●	
		04	1/2	—	—	●	
		06	3/4	—	—	●	
+							
④	Option (Mounting)	Nil	Without mounting option	●	●	●	
		B <small>Note 3</small>	With bracket	●	●	●	
+							
⑤	a	Bowl <small>Note 4</small>	Nil	Polycarbonate bowl	●	●	●
			2	Metal bowl	●	●	●
			6	Nylon bowl	●	●	●
			C	With bowl guard	●	— <small>Note 5</small>	— <small>Note 5</small>
			6C	With bowl guard (Nylon bowl)	●	— <small>Note 6</small>	— <small>Note 6</small>
+							
b	Drain port	Nil	With drain cock	●	●	●	
		J <small>Note 7</small>	Drain guide 1/8	●	—	—	
		W <small>Note 8</small>	Drain cock with barb fitting (for ø6 x ø4 nylon tube)	—	●	●	
+							
c	Flow direction	Nil	Flow direction: Left to right	●	●	●	
		R	Flow direction: Right to left	●	●	●	
+							
d	Pressure unit	Nil	Name plate and caution plate for bowl in imperial units: MPa	●	●	●	
		Z <small>Note 9</small>	Name plate and caution plate for bowl in imperial units: psi, °F	○ <small>Note 10</small>	○ <small>Note 10</small>	○ <small>Note 10</small>	

Note 1) Drain guide is NPT1/8 (applicable to the AF20-A) and NPT1/4 (applicable to the AF30-A to AF40-06-A).

Note 2) Drain guide is G1/8 (applicable to the AF20-A) and G1/4 (applicable to the AF30-A to AF40-06-A).

Note 3) A bracket is not assembled and supplied loose at the time of shipment. Including 2 mounting screws.

Note 4) Refer to Chemical data on page 433 for chemical resistance of the bowl.

Note 5) A bowl guard is provided as standard equipment (polycarbonate).

Note 6) A bowl guard is provided as standard equipment (nylon).

Note 7) Without a valve function

Note 8) The combination of metal bowl: 2 is not available.

Note 9) For pipe thread type: NPT. This product is for overseas use only according to the new Measurement Law. (The SI unit type is provided for use in Japan.)

Note 10) ○: For pipe thread type: NPT only

# Air Filter/AF20-A to AF40-06-A

# Made to Order

Please contact SMC for detailed dimensions, specifications and lead times.



## ② With Element Service Indicator

Clogging status of elements can be checked visually.

### Applicable Model

Model	AF20-A	AF30-A	AF40-A	AF40-06-A
Port size	1/8, 1/4	1/4, 3/8	1/4, 3/8, 1/2	3/4

AF **30** - **03** - **A-X2141**



• Option/Semi-standard: Select one each for a to f.  
 • Option/Semi-standard symbol: When more than one specification is required, indicate in alphanumeric order.  
 Example) AF30-03BD-2R-A-X2141

• With element service indicator

A special body type is required to mount the element service indicator. It cannot be mounted on a standard body.

		Symbol	Description	① Body size		
				20	30	40
②	Pipe thread type	Nil	Rc	●	●	●
		N <sup>Note 1)</sup>	NPT	●	●	●
		F <sup>Note 2)</sup>	G	●	●	●
+						
③	Port size	01	1/8	●	—	—
		02	1/4	●	●	●
		03	3/8	—	●	●
		04	1/2	—	—	●
		06	3/4	—	—	●
+						
④ Option	a Mounting	Nil	Without mounting option	●	●	●
		B <sup>Note 3)</sup>	With bracket	●	●	●
+						
④ Option	b Float type auto drain	Nil	Without auto drain	●	●	●
		C <sup>Note 4)</sup>	N.C. (Normally closed) Drain port is closed when pressure is not applied.	●	●	●
		D <sup>Note 5)</sup>	N.O. (Normally open) Drain port is open when pressure is not applied.	—	●	●
+						
⑤ Semi-standard	c Bowl <sup>Note 6)</sup>	Nil	Polycarbonate bowl	●	●	●
		2	Metal bowl	●	●	●
		6	Nylon bowl	●	●	●
		8	Metal bowl with level gauge	—	●	●
		C	With bowl guard	●	— <sup>Note 7)</sup>	— <sup>Note 7)</sup>
		6C	With bowl guard (Nylon bowl)	●	— <sup>Note 8)</sup>	— <sup>Note 8)</sup>
+						
⑤ Semi-standard	d Drain port <sup>Note 12)</sup>	Nil	With drain cock	●	●	●
		J <sup>Note 9)</sup>	Drain guide 1/8	●	—	—
		W <sup>Note 13)</sup>	Drain guide 1/4	—	●	●
			Drain cock with barb fitting (for ø6 x ø4 nylon tube)	—	●	●
+						
⑤ Semi-standard	e Flow direction	Nil	Flow direction: Left to right	●	●	●
		R	Flow direction: Right to left	●	●	●
+						
⑤ Semi-standard	f Pressure unit	Nil	Name plate and caution plate for bowl in imperial units: MPa	●	●	●
		Z <sup>Note 10)</sup>	Name plate and caution plate for bowl in imperial units: psi, °F	○ <sup>Note 11)</sup>	○ <sup>Note 11)</sup>	○ <sup>Note 11)</sup>

Note 1) Drain guide is NPT1/8 (applicable to the AF20-A) and NPT1/4 (applicable to the AF30-A to AF40-06-A).

The auto drain port comes with ø3/8" One-touch fitting (applicable to the AF30-A to AF40-06-A).

Note 2) Drain guide is G1/8 (applicable to the AF20-A) and G1/4 (applicable to the AF30-A to AF40-06-A).

Note 3) A bracket is not assembled and supplied loose at the time of shipment. Including 2 mounting screws.

Note 4) When pressure is not applied, condensate which does not start the auto drain mechanism will be left in the bowl.

Releasing the residual condensate before ending operations for the day is recommended.

Note 5) If the compressor is small (0.75 kW, discharge flow is less than 100 L/min [ANR]), air leakage from the drain cock may occur during start of operations. N.C. type is recommended.

Note 6) Refer to Chemical data on page 433 for chemical resistance of the bowl.

Note 7) A bowl guard is provided as standard equipment (polycarbonate).

Note 8) A bowl guard is provided as standard equipment (nylon).

Note 9) Without a valve function

Note 10) For pipe thread type: NPT. This product is for overseas use only according to the new Measurement Law. (The SI unit type is provided for use in Japan.)

Note 11) ○: For pipe thread type: NPT only

Note 12) The combination of float type auto drain: C and D is not available.

Note 13) The combination of metal bowl: 2 and 8 is not available.

# AF20-A to AF60-A Air Filter

## Made to Order

Please contact SMC for detailed dimensions, specifications and lead times.



### ③ Special Temperature Environment

Special materials are used in the manufacturing of seals and resin parts to allow them to withstand various temperature conditions in cold or tropical (hot) climates.

#### Specifications

Made-to-order part no.	-X430	-X440
Environment	Low temperature	High temperature
Ambient temperature [°C]	-30 to 60	-5 to 80
Fluid temperature [°C]	-5 to 60 (with no freezing)	
Material	Rubber parts	Special NBR FKM
	Main parts	Metal (Aluminum die-cast, etc.)

#### Applicable Model

Model	AF30-A	AF40-A	AF40-06-A	AF50-A	AF60-A
Port size	1/4, 3/8	1/4, 3/8, 1/2	3/4	3/4, 1	1

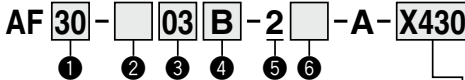

- Semi-standard: Select one each for a to c.
  - Semi-standard symbol: When more than one specification is required, indicate in alphabetic order.
- Example) AF30-03B-2R-A-X430

For high/low temperature

X430	Low temperature
X440	High temperature

	Symbol	Description	① Body size			
			30	40	50	60
② Pipe thread type	Nil	Rc	●	●	●	●
	N <sup>#1</sup>	NPT	●	●	●	●
	F <sup>#2</sup>	G	●	●	●	●

	Symbol	Description	③ Port size			
			1/4	3/8	1/2	3/4
③ Port size	02	1/4	●	●	—	—
	03	3/8	●	●	—	—
	04	1/2	—	—	●	—
	06	3/4	—	—	●	●

	Symbol	Description	④ Option (Mounting)			
			2	3	4	5
④ Option (Mounting)	Nil	Without mounting option	●	●	●	●
	B <sup>#3</sup>	With bracket	●	●	●	●

	Symbol	Description	⑤ Bowl <sup>#4</sup>			
			2	3	4	5
⑤ Bowl <sup>#4</sup>	2	Metal bowl	●	●	●	●
	8	Metal bowl with level gauge	—	—	●	●

	Symbol	Description	⑥ Semi-standard			
			a	b	c	d
a Drain port	Nil	With drain cock	●	●	●	●
	J <sup>#5</sup>	Drain guide 1/4	●	●	●	●

	Symbol	Description	⑥ Semi-standard			
			a	b	c	d
b Flow direction	Nil	Flow direction: Left to right	●	●	●	●
	R	Flow direction: Right to left	●	●	●	●

	Symbol	Description	⑥ Semi-standard			
			a	b	c	d
c Pressure unit	Nil	Name plate and caution plate for bowl in SI units: MPa	●	●	●	●
	Z <sup>#6</sup>	Name plate and caution plate for bowl in imperial units: psi, °F	○ <sup>#7</sup>	○ <sup>#7</sup>	○ <sup>#7</sup>	○ <sup>#7</sup>

- #1 Drain guide is NPT1/4.
- #2 Drain guide is G1/4.
- #3 A bracket is not assembled and supplied loose at the time of shipment. Including 2 mounting screws
- #4 Only metal bowl 2 is available.
- #5 Without a valve function
- #6 For pipe thread type: NPT. This product is for overseas use only according to the new Measurement Act. (The SI unit type is provided for use in Japan.)
- #7 ○: For pipe thread type: NPT only

### ④ High Pressure

Strong materials are used in the manufacturing of air filters intended for high pressure operation.

#### Specifications

Made-to-order part no.	-X425
Proof pressure [MPa]	3.0
Maximum operating pressure [MPa]	2.0
Ambient and fluid temperature [°C]	-5 to 60 (with no freezing)

#### Applicable Model

Model	AF20-A	AF30-A	AF40-A	AF40-06-A	AF50-A	AF60-A
Port size	1/8, 1/4	1/4, 3/8	1/4, 3/8, 1/2	3/4	3/4, 1	1

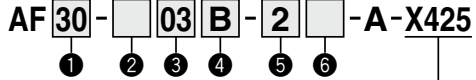

For high pressure

- Semi-standard: Select one each for a to c.
  - Semi-standard symbol: When more than one specification is required, indicate in alphabetic order.
- Example) AF30-03B-2R-A-X425

	Symbol	Description	① Body size			
			20	30	40	50
② Pipe thread type	Nil	Rc	●	●	●	●
	N <sup>#1</sup>	NPT	●	●	●	●
	F <sup>#2</sup>	G	●	●	●	●

	Symbol	Description	③ Port size			
			1/8	1/4	3/8	1/2
③ Port size	01	1/8	●	—	—	—
	02	1/4	●	●	—	—
	03	3/8	—	●	—	—
	04	1/2	—	—	●	—
	06	3/4	—	—	●	●

	Symbol	Description	④ Option (Mounting)			
			2	3	4	5
④ Option (Mounting)	Nil	Without mounting option	●	●	●	●
	B <sup>#3</sup>	With bracket	●	●	●	●

	Symbol	Description	⑤ Bowl <sup>#4</sup>			
			2	3	4	5
⑤ Bowl <sup>#4</sup>	2	Metal bowl	●	●	●	●
	8	Metal bowl with level gauge	—	—	●	●

	Symbol	Description	⑥ Semi-standard			
			a	b	c	d
a Drain port	Nil	With drain cock	●	●	●	●
	J <sup>#5</sup>	Drain guide 1/8	●	—	—	—
	J <sup>#5</sup>	Drain guide 1/4	—	●	—	—

	Symbol	Description	⑥ Semi-standard			
			a	b	c	d
b Flow direction	Nil	Flow direction: Left to right	●	●	●	●
	R	Flow direction: Right to left	●	●	●	●

	Symbol	Description	⑥ Semi-standard			
			a	b	c	d
c Pressure unit	Nil	Name plate and caution plate for bowl in SI units: MPa	●	●	●	●
	Z <sup>#6</sup>	Name plate and caution plate for bowl in imperial units: psi, °F	○ <sup>#7</sup>	○ <sup>#7</sup>	○ <sup>#7</sup>	○ <sup>#7</sup>

- #1 Drain guide is NPT1/8 (applicable to the AF20-A) and NPT1/4 (applicable to the AF30-A to AF60-A).
- #2 Drain guide is G1/8 (applicable to the AF20-A) and G1/4 (applicable to the AF30-A to AF60-A).
- #3 A bracket is not assembled and supplied loose at the time of shipment. Including 2 mounting screws
- #4 Only metal bowl 2 and 8 are available.
- #5 Without a valve function
- #6 For pipe thread type: NPT. This product is for overseas use only according to the new Measurement Act. (The SI unit type is provided for use in Japan.)
- #7 ○: For pipe thread type: NPT only

# AF20-A to AF60-A Air Filter Made to Order

Please contact SMC for detailed dimensions, specifications and lead times.



## ⑤ Clean Series

For details, refer to the Clean Series/Low Particle Generation section of the **Web Catalog**.



## 10 - Standard model no.

\* Please contact SMC if a product with pressure gauge is desired.

• Clean series

## ⑥ Copper, Fluorine and Silicone-free + Low Particle Generation

For details, refer to the Clean Series/Low Particle Generation section of the **Web Catalog**.

## 21 - Standard model no.

• Copper, fluorine and silicone-free + Low particle generation



# Mist Separator

# AFM20-A to AFM40-A

## Micro Mist Separator

# AFD20-A to AFD40-A

### Symbol

Mist Separator

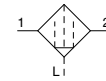

Micro Mist Separator

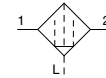

AFM20-A



AFD40-A

- AFM Series Nominal filtration rating: 0.3 μm
- AFD Series Nominal filtration rating: 0.01 μm

### How to Order

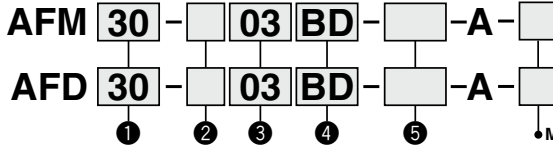

- Option/Semi-standard: Select one each for a to f.
- Option/Semi-standard symbol: When more than one specification is required, indicate in alphanumeric order. Example) AFM30-03BD-R-A

### • Made to Order

(Refer to pages 446 and 447 for details.)

	Symbol	Description	①		
			Body size		
			20	30	40
②	Pipe thread type	Nil	●	●	●
		N <sup>Note 1)</sup>	●	●	●
		F <sup>Note 2)</sup>	●	●	●
③	Port size	+			
		01	●	—	—
		02	●	●	●
		03	—	●	●
		04	—	—	●
		06	—	—	●
④	a	Mounting	Nil	●	●
			B <sup>Note 3)</sup>	●	●
	b	Float type auto drain	Nil	●	●
			C <sup>Note 4)</sup>	●	●
D <sup>Note 5)</sup>			—	●	
⑤	c	Bowl <sup>Note 6)</sup>	Nil	●	●
			2	●	●
			6	●	●
			8	—	—
			C	●	— <sup>Note 7)</sup>
			6C	●	— <sup>Note 8)</sup>
	d	Drain port <sup>Note 12)</sup>	Nil	●	●
			J <sup>Note 9)</sup>	●	—
			W <sup>Note 13)</sup>	—	●
			W <sup>Note 13)</sup>	—	●
e	Flow direction	Nil	●	●	
		R	●	●	
f	Pressure unit	Nil	●	●	
		Z <sup>Note 10)</sup>	○ <sup>Note 11)</sup>	○ <sup>Note 11)</sup>	

Note 1) Drain guide is NPT1/8 (applicable to the AFM20-A, AFD20-A) and NPT1/4 (applicable to the AFM30-A/40-A, AFD30-A/40-A).

The auto drain port comes with ø3/8" One-touch fitting (applicable to the AFM30-A/40-A, AFD30-A/40-A).

Note 2) Drain guide is G1/8 (applicable to the AFM20-A, AFD20-A) and G1/4 (applicable to the AFM30-A/40-A, AFD30-A/40-A).

Note 3) A bracket is not assembled and supplied loose at the time of shipment. Including 2 mounting screws.

Note 4) When pressure is not applied, condensate which does not start the auto drain mechanism will be left in the bowl.

Releasing the residual condensate before ending operations for the day is recommended.

Note 5) If the compressor is small (0.75 kW, discharge flow is less than 100 L/min [ANR]), air leakage from the drain cock may occur during start of operations. N.C. type is recommended.

Note 6) Refer to Chemical data on page 443 for chemical resistance of the bowl.

Note 7) A bowl guard is provided as standard equipment (polycarbonate).

Note 8) A bowl guard is provided as standard equipment (nylon).

Note 9) Without a valve function.

Note 10) For pipe thread type: NPT. This product is for overseas use only according to the new Measurement Law. (The SI unit type is provided for use in Japan.)

Note 11) ○: For pipe thread type: NPT only.

Note 12) The combination of float type auto drain: C and D is not available.

Note 13) The combination of metal bowl: 2 and 8 is not available.

# Mist Separator **AFM20-A to AFM40-A Series** Micro Mist Separator **AFD20-A to AFD40-A Series**

## Standard Specifications

Model		AFM20-A AFD20-A	AFM30-A AFD30-A	AFM40-A AFD40-A	AFM40-06-A AFD40-06-A
<b>Port size</b>		1/8, 1/4	1/4, 3/8	1/4, 3/8, 1/2	3/4
<b>Fluid</b>		Air			
<b>Ambient and fluid temperature</b>		- 5 to 60°C (with no freezing)			
<b>Proof pressure</b>		1.5 MPa			
<b>Maximum operating pressure</b>		1.0 MPa			
<b>Minimum operating pressure</b>		0.05 MPa			
<b>Nominal filtration rating</b>	AFM20-A to AFM40-06-A	0.3 μm (99.9% filtered particle size)			
	AFD20-A to AFD40-06-A	0.01 μm (99.9% filtered particle size)			
<b>Outlet side oil mist concentration</b>	AFM20-A to AFM40-06-A	Max. 1.0 mg/m <sup>3</sup> (ANR) (≈ 0.8 ppm) <sup>Note 2) Note 3)</sup>			
	AFD20-A to AFD40-06-A	Max. 0.1 mg/m <sup>3</sup> (ANR) (Before saturated with oil 0.01 mg/m <sup>3</sup> (ANR) or less = 0.008 ppm) <sup>Note 2) Note 3)</sup>			
<b>Rated flow (L/min (ANR))</b> <sup>Note 1)</sup>	AFM20-A to AFM40-06-A	200	450	1100	
	AFD20-A to AFD40-06-A	120	240	600	
<b>Drain capacity (cm<sup>3</sup>)</b>		8	25	45	
<b>Bowl material</b>		Polycarbonate			
<b>Bowl guard</b>		Semi-standard (Steel)		Standard (Polycarbonate)	
<b>Weight (kg)</b>		0.09	0.19	0.38	0.43

Note 1) Conditions: Inlet pressure: 0.7 MPa; The rated flow varies depending on the inlet pressure.

Keep the air flow within the rated flow to prevent an outflow of lubricant to the outlet side.

Note 2) When the compressor oil mist discharge concentration is 30 mg/m<sup>3</sup> (ANR).

Note 3) Bowl seal and other O-rings are slightly lubricated.

## Options/Part No.

Optional specifications	Model			
	AFM20-A AFD20-A	AFM30-A AFD30-A	AFM40-A AFD40-A	AFM40-06-A AFD40-06-A
<b>Bracket assembly</b> <sup>Note 1)</sup>	AF22P-050AS	AF32P-050AS	AF42P-050AS	AF42P-070AS
<b>Float type auto drain</b> <sup>Note 2) Note 3)</sup>	N.C.	AD27-A	AD37-A	AD47-A
	N.O.	—	AD38-A	AD48-A

Note 1) Assembly of a bracket and 2 mounting screws

Note 2) Minimum operating pressure: N.O. type-0.1 MPa; N.C. type-0.1 MPa (AD27-A) and 0.15 MPa (AD37-A/AD47-A).

Please consult with SMC separately for psi and °F unit display specifications.

Note 3) Please consult with SMC for details on drain piping to fit NPT or G port sizes.

## Bowl Assembly/Part No.

Bowl material	Drain discharge mechanism	Drain port	Other	Model				
				AFM20-A AFD20-A	AFM30-A AFD30-A	AFM40-A AFD40-A	AFM40-06-A AFD40-06-A	
Polycarbonate bowl	Manual discharge	With drain cock	—	C2SF-A	—	—	—	
		With bowl guard	With bowl guard	C2SF-C-A	C3SF-A	C4SF-A	—	
		Drain cock with barb fitting	With bowl guard	—	C3SF-W-A	C4SF-W-A	—	
	Automatic <sup>Note 3)</sup> discharge (Auto drain)	With drain guide (without valve function)	With bowl guard	—	C2SF□-J-A	—	—	—
		With bowl guard	With bowl guard	C2SF□-CJ-A	C3SF□-J-A	C4SF□-J-A	—	
		Normally closed (N.C.)	With bowl guard	—	AD27-A	—	—	—
Nylon bowl	Manual discharge	Normally open (N.O.)	With bowl guard	AD27-C-A	AD37□-A	AD47□-A	—	
		With bowl guard	With bowl guard	—	AD38□-A	AD48□-A	—	
		With drain cock	With bowl guard	—	C2SF-6-A	—	—	
	Automatic <sup>Note 3)</sup> discharge (Auto drain)	With drain cock with barb fitting	With bowl guard	With bowl guard	C2SF-6C-A	C3SF-6-A	C4SF-6-A	—
		With bowl guard	With bowl guard	—	C3SF-6W-A	C4SF-6W-A	—	
		With drain guide (without valve function)	With bowl guard	With bowl guard	C2SF□-6J-A	—	—	—
Metal bowl	Manual discharge	Normally closed (N.C.)	With bowl guard	AD27-6-A	—	—	—	
		With bowl guard	With bowl guard	AD27-6C-A	AD37□-6-A	AD47□-6-A	—	
		Normally open (N.O.)	With bowl guard	—	AD38□-6-A	AD48□-6-A	—	
	Automatic <sup>Note 3)</sup> discharge (Auto drain)	With drain cock	With level gauge	—	C2SF-2-A	C3SF-2-A	C4SF-2-A	—
		With drain guide (without valve function)	With level gauge	—	—	C3LF-8-A	C4LF-8-A	—
		With bowl guard	With level gauge	—	C2SF□-2J-A	C3SF□-2J-A	C4SF□-2J-A	—
Automatic <sup>Note 3)</sup> discharge (Auto drain)	Normally closed (N.C.)	With level gauge	—	—	C3LF□-8J-A	C4LF□-8J-A	—	
	With level gauge	With level gauge	—	AD27-2-A	AD37□-2-A	AD47□-2-A	—	
	Normally open (N.O.)	With level gauge	—	—	AD38□-2-A	AD48□-2-A	—	
		With level gauge	—	AD38□-8-A	AD48□-8-A	—		

Note) Minimum operating pressure: N.O. type-0.1 MPa (AD38-A, AD48-A); N.C. type-0.1 MPa (AD17-A, AD27-A) and 0.15 MPa (AD37-A, AD47-A).

Bowl assembly for the AFM20-A to AFM40-06-A, AFD20-A to AFD40-06-A models comes with a bowl seal.

□ in bowl assembly part numbers indicates a pipe thread type (applicable tubing for auto drain). No indication is necessary for Rc thread; however, indicate N for NPT thread, and F for G thread. (For auto drain, Nil: ø10, Nil: ø3/8")

Please consult with SMC separately for psi and °F unit display specifications.



# AFM20-A to AFM40-A Series

## AFD20-A to AFD40-A Series

### Flow Rate Characteristics (Representative values)

— When saturated with oil  
 - - - Initial state

AFM20-A

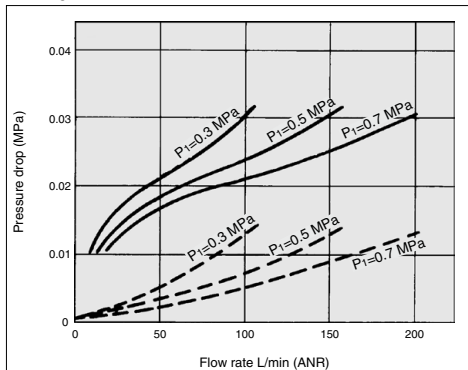

AFD20-A

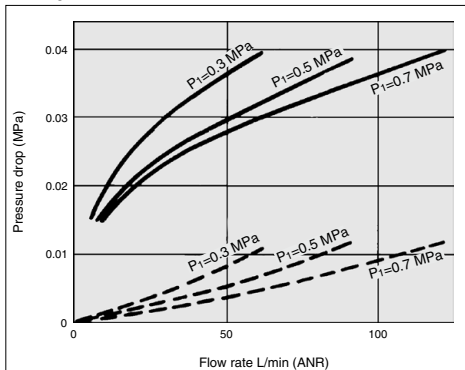

AFM30-A

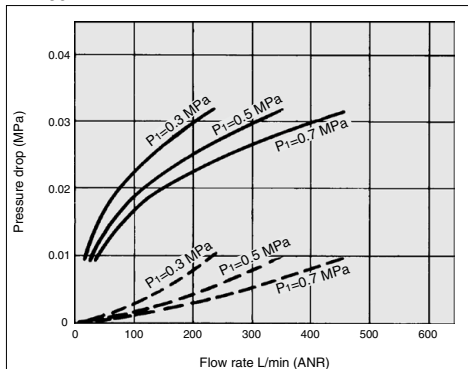

AFD30-A

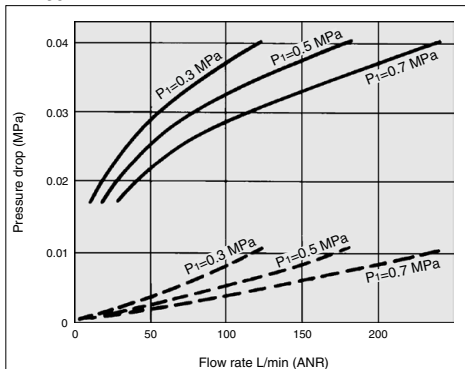

AFM40-A

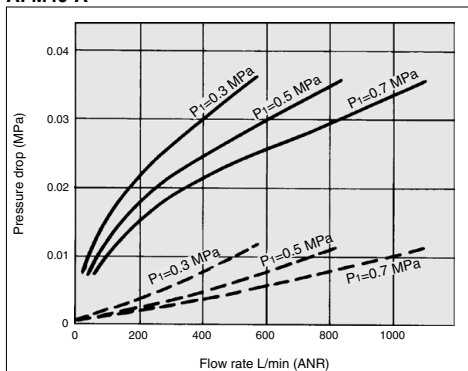

AFD40-A

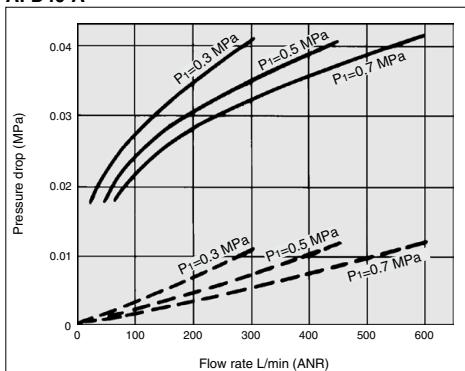



# Mist Separator **AFM20-A to AFM40-A Series** Micro Mist Separator **AFD20-A to AFD40-A Series**

## ⚠ Specific Product Precautions

Be sure to read this before handling the products. Refer to back page 50 for Safety Instructions and pages 387 to 391 for F.R.L. Precautions.

### Design/Selection

#### ⚠ Warning

- The standard bowl for the air filter, filter regulator, and lubricator, as well as the sight dome for the lubricator are made of polycarbonate. Do not use in an environment where they are exposed to or come in contact with organic solvents, chemicals, cutting oil, synthetic oil, alkali, and thread lock solutions.

Effects of atmosphere of organic solvents and chemicals, and where these elements are likely to adhere to the equipment.

Chemical data for substances causing degradation (Reference)

Type	Chemical name	Application examples	Material	
			Polycarbonate	Nylon
Acid	Hydrochloric acid Sulfuric acid, Phosphoric acid Chromic acid	Acid washing liquid for metals	△	×
Alkaline	Sodium hydroxide (Caustic soda) Potash Calcium hydroxide (Slack lime) Ammonia water Carbonate of soda	Degreasing of metals Industrial salts Water-soluble cutting oil	×	○
Inorganic salts	Sodium sulfide Sulfate of potash Sulfate of soda	—	×	△
Chlorine solvents	Carbon tetrachloride Chloroform Ethylene chloride Methylene chloride	Cleansing liquid for metals Printing ink Dilution	×	△
Aromatic series	Benzene Toluene Paint thinner	Coatings Dry cleaning	×	△
Ketone	Acetone Methyl ethyl ketone Cyclohexane	Photographic film Dry cleaning Textile industries	×	×
Alcohol	Ethyl alcohol IPA Methyl alcohol	Antifreeze Adhesives	△	×
Oil	Gasoline Kerosene	—	×	○
Ester	Phthalic acid dimethyl Phthalic acid diethyl Acetic acid	Synthetic oil Anti-rust additives	×	○
Ether	Methyl ether Ethyl ether	Brake oil additives	×	○
Amino	Methyl amino	Cutting oil Brake oil additives Rubber accelerator	×	×
Others	Thread-lock fluid Seawater Leak tester	—	×	△

○: Essentially safe    △: Some effects may occur.    ×: Effects will occur.

When the above factors are present, or there is some doubt, use a metal bowl for safety.

### Air Supply

#### ⚠ Caution

- Install an air filter (AF series) as a pre-filter on the inlet side of the mist separator to prevent premature clogging.
- Install a mist separator (AFM series) as a pre-filter on the inlet side of the micro mist separator to prevent premature clogging.
- Do not install on the inlet side of the dryer as this can cause premature clogging of the element.

### Maintenance

#### ⚠ Warning

- Replace the element every 2 years or when the pressure drop becomes 0.1 MPa, whichever comes first, to prevent damage to the element.

### Mounting/Adjustment

#### ⚠ Caution

- When the bowl is installed on the mist separator (AFM30-A/AFM40-A), or micro mist separator (AFD30-A/AFD40-A), install them so that the lock button lines up to the groove of the front (or the back) of the body to avoid drop or damage of the bowl.



### Design

#### ⚠ Caution

- Design the system so that the mist separator is installed in a pulsation-free location. The difference between internal and external pressure inside the element should be kept within 0.1 MPa, as exceeding this value could cause damage.

### Selection

#### ⚠ Caution

- Do not allow air flow that exceeds the rated flow. If the air flow is allowed outside the range of the rated flow even momentarily, drainage and lubricant may splash at the outlet side or cause damage to the component.
- Do not use in a low pressure application (such as a blower). An F.R.L. unit has its own minimum operating pressure depending on the equipment and is designed specifically to function with compressed air. If used below the minimum operating pressure, a loss of performance and malfunction can occur. Please contact SMC if an application under such conditions cannot be avoided.

AC-A

AF-A

AFM-A

AR-A

AL-A

AW-A

AC-B

AF-A

AFM-A

AR-A

AL-A

AW-A

AW

AG

E

AV

AF

# AFM20-A to AFM40-A Series

## AFD20-A to AFD40-A Series

### Construction

AFM20-A  
AFD20-A

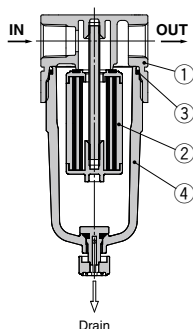

AFM30-A to AFM40-06-A  
AFD30-A to AFD40-06-A

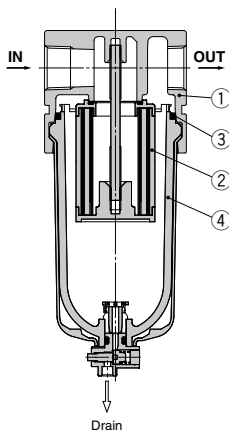

### Component Parts

No.	Description	Material	Model	Color
1	Body	Aluminum die-cast	AFM20-A to AFM40-06-A AFD20-A to AFD40-06-A	White

### Replacement Parts

No.	Description		Material	Part no.			
				AFM20-A AFD20-A	AFM30-A AFD30-A	AFM40-A AFD40-A	AFM40-06-A AFD40-06-A
2	Element assembly	AFM20 to 40	—	AFM20P-060AS	AFM30P-060AS	AFM40P-060AS	
		AFD20 to 40	—	AFD20P-060AS	AFD30P-060AS	AFD40P-060AS	
3	Bowl seal	NBR	C2SFP-260S	C32FP-260S	C42FP-260S		
4	Bowl assembly <sup>(Note)</sup>	Polycarbonate	C2SF-A	C3SF-A	C4SF-A		

Note) Bowl seal is included. Please contact SMC regarding the supply of bowl assembly with psi and °F unit display specifications.

# Mist Separator **AFM20-A to AFM40-A Series** Micro Mist Separator **AFD20-A to AFD40-A Series**

## Dimensions

### AFM20-A AFD20-A

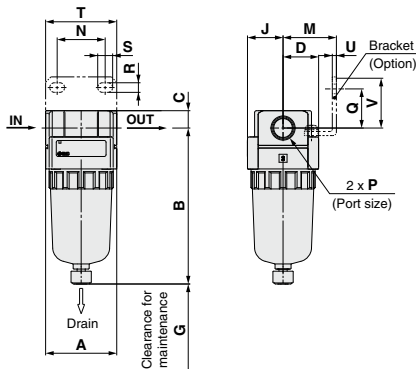

### AFM30-A to AFM40-06-A AFD30-A to AFD40-06-A

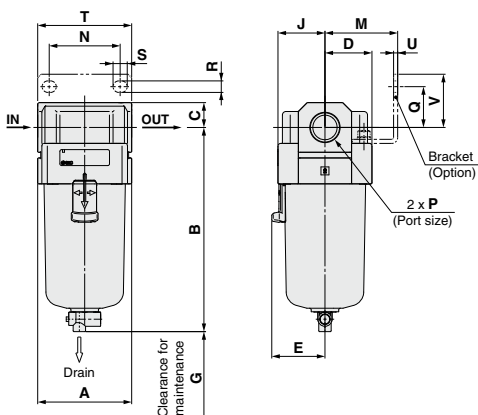

Applicable model	AFM20-A/AFD20-A				AFM30-A to AFM40-06-A/AFD30-A to AFD40-06-A
Optional/Semi-standard specifications	With auto drain (N.C.)	With drain guide	Metal bowl	Metal bowl with drain guide	With auto drain (N.O./N.C.)
Dimensions	 M5 x 0.8	 Width across flats 14 1/8	 A	 Width across flats 14 1/8	 N.O.: Black N.C.: Gray Thread type/Rc: G: ø10 One-touch fitting Thread type/NPT: ø3/8" One-touch fitting

Applicable model	AFM30-A to AFM40-06-A/AFD30-A to AFD40-06-A					
Optional/Semi-standard specifications	Metal bowl	Metal bowl with drain guide	Metal bowl with level gauge	Metal bowl with level gauge, with drain guide	With drain guide	Drain cock with barb fitting
Dimensions	 A	 Width across flats 17 1/4	 A	 Width across flats 17 1/4	 Width across flats 17 1/4	 Barb fitting applicable tubing: T0604

Model	Standard specifications								Optional specifications								
	P	A	B	C	D	E	G	J	M	N	Q	R	S	T	U	V	B
AFM20-A/AFD20-A	1/8, 1/4	40	87.6	9.8	20	—	40	20	30	27	22	5.4	8.4	40	2.3	28	104.9
AFM30-A/AFD30-A	1/4, 3/8	53	115.1	14	26.7	30	50	26.7	41	35	23	6.5	13	53	2.3	30	156.8
AFM40-A/AFD40-A	1/4, 3/8, 1/2	70	147.1	18	35.5	38.4	75	35.5	50	52	26	8.5	12.5	70	2.3	35	186.9
AFM40-06-A/AFD40-06-A	3/4	75	149.1	20	35.5	38.4	75	35.5	50	52	25	8.5	12.5	70	2.3	34	188.9

Model	Semi-standard specifications					
	With barb fitting	With drain guide	Metal bowl	Metal bowl with drain guide	Metal bowl with level gauge	Metal bowl with level gauge, with drain guide
AFM20-A/AFD20-A	—	B	B	B	B	—
AFM30-A/AFD30-A	123.6	121.9	117.6	122.1	137.6	142.1
AFM40-A/AFD40-A	155.6	153.9	149.6	154.1	169.6	174.1
AFM40-06-A/AFD40-06-A	157.6	155.9	151.6	156.1	171.6	176.1

- AC-A
- AF-A
- AFD-A
- AR-A
- AL-A
- AW-A
- AC-B
- AF-A
- AFD-A
- AR-B
- AL-A
- AW-B
- AW
- AG
- E
- AV
- AF

# Mist Separator/AFM20-A to AFM40-06-A Micro Mist Separator/AFD20-A to AFD40-06-A

## Made to Order



Please contact SMC for detailed dimensions, specifications and lead times.

### ① Long Bowl

Drain capacity is greater than that of standard models.

#### Applicable Model/Drain Capacity

Model	AFM20-A, AFD20-A	AFM30-A, AFD30-A	AFM40-A, AFD40-A	AFM40-06-A, AFD40-06-A
Port size	1/8, 1/4	1/4, 3/8	1/4, 3/8, 1/2	3/4
Drain capacity (cm <sup>3</sup> )	19	43	88	
B dimension (mm) <sup>Note</sup>	108.6	137.1	167.2	169.2

Note) For polycarbonate bowls. Please contact SMC for other bowl materials.

AFM **30** - **03** - **03** - **03** - **A** - **X64**

AFD **30** - **03** - **03** - **03** - **A** - **X64**



AFM20-A  
AFD20-A

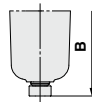

AFM30 to 40-06-A  
AFD30 to 40-06-A

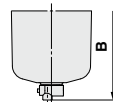

- Semi-standard: Select one each for a to d.
- Option/Semi-standard symbol: When more than one specification is required, indicate in alphanumeric order.  
Example) AFM30-03B-2R-A-X64

		Symbol	Description	① Body size			
				20	30	40	
②	Pipe thread type	Nil	Rc	●	●	●	
		N <sup>Note 1)</sup>	NPT	●	●	●	
		F <sup>Note 2)</sup>	G	●	●	●	
③	Port size	+					
		01	1/8	●	—	—	
		02	1/4	●	●	●	
		03	3/8	—	●	●	
		04	1/2	—	—	●	
		06	3/4	—	—	●	
④	Option (Mounting)	Nil	Without mounting option	●	●	●	
		B <sup>Note 3)</sup>	With bracket	●	●	●	
⑤	a	Bowl <sup>Note 4)</sup>	Nil	Polycarbonate bowl	●	●	●
			2	Metal bowl	●	●	●
			6	Nylon bowl	●	●	●
			C	With bowl guard	●	— <sup>Note 5)</sup>	— <sup>Note 5)</sup>
			6C	With bowl guard (Nylon bowl)	●	— <sup>Note 6)</sup>	— <sup>Note 6)</sup>
	b	Drain port	Nil	With drain cock	●	●	●
			J <sup>Note 7)</sup>	Drain guide 1/8	●	—	—
			W <sup>Note 8)</sup>	Drain cock with barb fitting (for ø6 x ø4 nylon tube)	—	●	●
	c	Flow direction	Nil	Flow direction: Left to right	●	●	●
			R	Flow direction: Right to left	●	●	●
d	Pressure unit	Nil	Name plate and caution plate for bowl in imperial units: MPa	○ <sup>Note 10)</sup>	●	●	
		Z <sup>Note 9)</sup>	Name plate and caution plate for bowl in imperial units: psi, °F	○ <sup>Note 10)</sup>	○ <sup>Note 10)</sup>	○ <sup>Note 10)</sup>	

Note 1) Drain guide is NPT1/8 (applicable to the AFM20-A, AFD20-A) and NPT1/4 (applicable to the AFM30-A/40-A, AFD30-A/40-A).

Note 2) Drain guide is G1/8 (applicable to the AFM20-A, AFD20-A) and G1/4 (applicable to the AFM30-A/40-A, AFD30-A/40-A).

Note 3) A bracket is not assembled and supplied loose at the time of shipment. Including 2 mounting screws.

Note 4) Refer to Chemical data on page 443 for chemical resistance of the bowl.

Note 5) A bowl guard is provided as standard equipment (polycarbonate).

Note 6) A bowl guard is provided as standard equipment (nylon).

Note 7) Without a valve function.

Note 8) The combination of metal bowl: 2 is not available.

Note 9) For pipe thread type: NPT. This product is for overseas use only according to the new Measurement Law. (The SI unit type is provided for use in Japan.)

Note 10) ○: For pipe thread type: NPT only

# Mist Separator/AFM20-A to AFM40-06-A Micro Mist Separator/AFD20-A to AFD40-06-A

## Made to Order



Please contact SMC for detailed dimensions, specifications and lead times.

### ② With Element Service Indicator

Clogging status of elements can be checked visually.

#### Applicable Model

Model	AFM20-A, AFD20-A	AFM30-A, AFD30-A	AFM40-A, AFD40-A	AFM40-06-A, AFD40-06-A
Port size	1/8, 1/4	1/4, 3/8	1/4, 3/8, 1/2	3/4

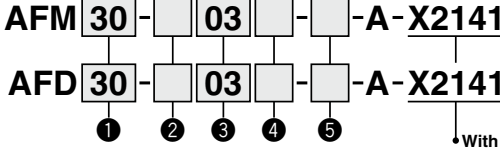

- Option/Semi-standard: Select one each for a to f.
- Option/Semi-standard symbol: When more than one specification is required, indicate in alphanumeric order.  
Example) AFM30-03BD-2R-A-X2141

A special body type is required to mount the element service indicator. It cannot be mounted on a standard body.

	Symbol	Description	① Body size				
			20	30	40		
②	Pipe thread type	<b>Nil</b>	Rc	●	●	●	
		<b>N</b> <small>Note 1)</small>	NPT	●	●	●	
		<b>F</b> <small>Note 2)</small>	G	●	●	●	
+							
③	Port size	<b>01</b>	1/8	●	—	—	
		<b>02</b>	1/4	●	●	●	
		<b>03</b>	3/8	—	●	●	
		<b>04</b>	1/2	—	—	●	
		<b>06</b>	3/4	—	—	●	
+							
④	a	Mounting	<b>Nil</b>	Without mounting option	●	●	●
			<b>B</b> <small>Note 3)</small>	With bracket	●	●	●
+							
④	b	Float type auto drain	<b>Nil</b>	Without auto drain	●	●	●
			<b>C</b> <small>Note 4)</small>	N.C. (Normally closed) Drain port is closed when pressure is not applied.	●	●	●
			<b>D</b> <small>Note 5)</small>	N.O. (Normally open) Drain port is open when pressure is not applied.	—	●	●
+							
⑤	c	Bowl <small>Note 6)</small>	<b>Nil</b>	Polycarbonate bowl	●	●	●
			<b>2</b>	Metal bowl	●	●	●
			<b>6</b>	Nylon bowl	●	●	●
			<b>8</b>	Metal bowl with level gauge	—	—	●
			<b>C</b>	With bowl guard	●	— <small>Note 7)</small>	— <small>Note 7)</small>
			<b>6C</b>	With bowl guard (Nylon bowl)	●	— <small>Note 8)</small>	— <small>Note 8)</small>
+							
⑤	d	Drain port <small>Note 12)</small>	<b>Nil</b>	With drain cock	●	●	●
			<b>J</b> <small>Note 9)</small>	Drain guide 1/8	—	—	—
			<b>W</b> <small>Note 13)</small>	Drain guide 1/4	—	—	●
			<b>W</b> <small>Note 13)</small>	Drain cock with barb fitting (for ø6 x ø4 nylon tube)	—	●	●
+							
⑤	e	Flow direction	<b>Nil</b>	Flow direction: Left to right	●	●	●
			<b>R</b>	Flow direction: Right to left	●	●	●
+							
⑤	f	Pressure unit	<b>Nil</b>	Name plate and caution plate for bowl in imperial units: MPa	●	●	●
			<b>Z</b> <small>Note 10)</small>	Name plate and caution plate for bowl in imperial units: psi, "F	○ <small>Note 11)</small>	○ <small>Note 11)</small>	○ <small>Note 11)</small>

Note 1) Drain guide is NPT1/8 (applicable to the AFM20-A, AFD20-A) and NPT1/4 (applicable to the AFM30-A/40-A, AFD30-A/40-A). The auto drain port comes with ø3/8" One-touch fitting (applicable to the AFM30-A/40-A, AFD30-A/40-A).

Note 2) Drain guide is G1/8 (applicable to the AFM20-A, AFD20-A) and G1/4 (applicable to the AFM30-A/40-A, AFD30-A/40-A).

Note 3) A bracket is not assembled and supplied loose at the time of shipment. Including 2 mounting screws.

Note 4) When pressure is not applied, condensate which does not start the auto drain mechanism will be left in the bowl. Releasing the residual condensate before ending operations for the day is recommended.

Note 5) If the compressor is small (0.75 kW, discharge flow is less than 100 L/min [ANR]), air leakage from the drain cock may occur during start of operations. N.C. type is recommended.

Note 6) Refer to Chemical data on page 443 for chemical resistance of the bowl.

Note 7) A bowl guard is provided as standard equipment (polycarbonate).

Note 8) A bowl guard is provided as standard equipment (nylon).

Note 9) Without a valve function

Note 10) For pipe thread type: NPT. This product is for overseas use only according to the new Measurement Law. (The SI unit type is provided for use in Japan.)

Note 11) ○: For pipe thread type: NPT only

Note 12) The combination of float type auto drain: C and D is not available.

Note 13) The combination of metal bowl: 2 and 8 is not available.

# AFM20-A to AFM40-06-A Mist Separator AFD20-A to AFD40-06-A Micro Mist Separator Made to Order

Please contact SMC for detailed dimensions, specifications and lead times.



## ③ Clean Series

For details, refer to the Clean Series/Low Particle Generation section of the **Web Catalog**.

### 10 - Standard model no.

\* Please contact SMC if a product with pressure gauge is desired.

- Clean series

## ④ Copper, Fluorine and Silicone-free + Low Particle Generation

For details, refer to the Clean Series/Low Particle Generation section of the **Web Catalog**.

### 21 - Standard model no.

- Copper, fluorine and silicone-free + Low particle generation

# Modular Type Regulator **AR Series**

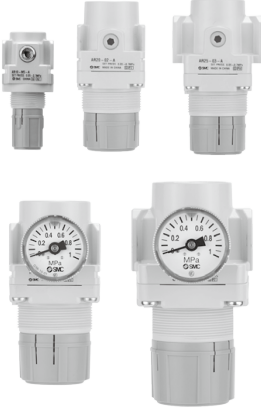
Regulator AR Series	Model	Port size	Options
 <p data-bbox="115 898 236 919">P.450 to 457</p>	AR10-A	M5 x 0.8	<p data-bbox="837 539 897 560">Bracket</p> <p data-bbox="760 644 972 665">Round type pressure gauge</p> <p data-bbox="768 740 964 761">Set nut (for panel mount)*</p> <p data-bbox="745 879 986 927">* For AR20-A to AR40-06-A, panel fitting dimensions are different from those of the current AR series.</p>
	AR20-A	1/8, 1/4	
	AR25-A	1/4, 3/8	
	AR30-A		
	AR40-A	1/4, 3/8, 1/2	
	AR40-06-A	3/4	

## Made to Order

①	<p data-bbox="141 1010 350 1031"><b>0.4 MPa Setting (-X406)</b></p> <p data-bbox="141 1031 572 1090">The maximum set pressure is 0.4 MPa. When a pressure gauge is included, the display will show a range from 0 to 0.7 MPa.</p>	<p data-bbox="624 1086 729 1107"><b>P.456, 457</b></p>
②	<p data-bbox="141 1106 370 1126"><b>0.85 MPa Setting (-X2068)</b></p> <p data-bbox="141 1126 580 1185">The maximum set pressure is 0.85 MPa. When a pressure gauge is included, the display will show a range from 0 to 1.0 MPa.</p>	

AC-A  
AF-A  
AF-A  
AR-A  
AL-A  
AW-A  
AC-B  
AF-A  
AF-A  
AR-A  
AL-A  
AW-A  
AW-□  
AC-G  
E-□  
AV  
AF

# Regulator

# AR10-A to AR40-A

Symbol  
Regulator

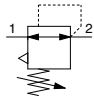

## How to order

AR 30 -   03 BG -   - A -  

1   
 2   
 3   
 4   
 5

- Option/Semi-standard: Select one each for a to g.
- Option/Semi-standard symbol: When more than one specification is required, indicate in alphanumeric order.  
Example) AR30-03BG-1N-A

### • Made to Order

(Refer to pages 456 and 457 for details.)

		Symbol	Description	① Body size					
				10	20	25	30	40	
②	Pipe thread type	Nil	Metric thread (M5)	●	—	—	—	—	
			Rc	—	●	●	●	●	
			NPT	—	●	●	●	●	
			G	—	●	●	●	●	
+									
③	Port size	M5	M5	●	—	—	—	—	
		01	1/8	—	●	—	—	—	
		02	1/4	—	●	●	—	—	
		03	3/8	—	—	●	●	●	
		04	1/2	—	—	—	—	●	
+									
④	a	Mounting	Nil	Without mounting option	●	●	●	●	●
			B <sup>Note 2)</sup>	With bracket	●	●	●	●	●
			H	With set nut (for panel mount) <sup>Note 3)</sup>	●	●	●	●	●
+									
④	b	Pressure gauge <sup>Note 4)</sup>	Nil	Without pressure gauge	●	●	●	●	●
			G	Round type pressure gauge (without limit indicator)	●	—	—	—	—
			M	Round type pressure gauge (with color zone)	—	●	●	●	●
+									
⑤	c	Set pressure <sup>Note 5)</sup>	Nil	0.05 to 0.7 MPa setting	●	●	●	●	●
			1	0.02 to 0.2 MPa setting	●	●	●	●	●
+									
⑤	d	Exhaust mechanism	Nil	Relieving type	●	●	●	●	●
			N	Non-relieving type	●	●	●	●	●
+									
⑤	e	Flow direction	Nil	Flow direction: Left to right	●	●	●	●	●
			R	Flow direction: Right to left	●	●	●	●	●
+									
⑤	f	Knob	Nil	Downward	●	●	●	●	●
			Y	Upward	●	●	●	●	●
+									
⑤	g	Pressure unit	Nil	Name plate and pressure gauge in imperial units: MPa	●	●	●	●	●
			Z <sup>Note 6)</sup>	Name plate and pressure gauge in imperial units: psi	○ <sup>Note 7)</sup>	○ <sup>Note 7)</sup>	○ <sup>Note 7)</sup>	○ <sup>Note 7)</sup>	○ <sup>Note 7)</sup>

Note 1) Option B, G, H, M are not assembled and supplied loose at the time of shipment.

Note 2) Assembly of a bracket and set nuts

Note 3) Mounting pitch is different from that of the current AR20 to AR40 and AR20-B to AR40-B.

Note 4) When the pressure gauge is attached, a 1.0 MPa pressure gauge will be fitted for standard (0.7 MPa) type, 0.4 MPa pressure gauge for 0.2 MPa type (1.0 MPa pressure gauge only for the AR10-A).

Note 5) Pressure can be set higher than the specification pressure in some cases, but use pressure within the specification range.

Note 6) For pipe thread type: NPT

This product is for overseas use only according to the new Measurement Law. (The SI unit type is provided for use in Japan.)

Cannot be used with M: Round pressure gauge (with color zone). Available by request for special.

Note 7) ○: For pipe thread type: M5, NPT only



## Standard Specifications

Model	AR10-A	AR20-A	AR25-A	AR30-A	AR40-A	AR40-06-A
Port size	M5 x 0.8	1/8, 1/4	1/4, 3/8	1/4, 3/8	1/4, 3/8, 1/2	3/4
Pressure gauge port size	1/16 <sup>Note)</sup>		1/8			
Fluid	Air					
Ambient and fluid temperature	- 5 to 60°C (with no freezing)					
Proof pressure	1.5 MPa					
Maximum operating pressure	1.0 MPa					
Set pressure range	0.05 to 0.7 MPa					
Construction	Relieving type					
Weight (kg)	0.06	0.17	0.19	0.34	0.58	0.60

Note) Use a bushing (part no: 131368) when connecting the R1/8 pressure gauge to the Rc1/16.

## Options/Part No.

Optional specifications		Model					
		AR10-A	AR20-A	AR25-A	AR30-A	AR40-A	AR40-06-A
Bracket assembly <sup>Note 1)</sup>		AR12P-270AS	AR22P-270AS	AR27P-270AS	AR32P-270AS	AR42P-270AS	AR42P-270AS
Set nut		AR12P-260S	AR22P-260S	AR22P-260S	AR32P-260S	AR42P-260S	AR42P-260S
Pressure gauge	Round type <sup>Note 2)</sup>	Standard	G27-10-R1	G36-10-□01		G46-10-□01	
		0.02 to 0.2 MPa setting	G27-10-R1 <sup>Note 3)</sup>	G36-4-□01		G46-4-□01	
	Round type <sup>Note 2)</sup> (with color zone)	Standard	—	G36-10-□01-L		G46-10-□01-L	
		0.02 to 0.2 MPa setting	—	G36-4-□01-L		G46-4-□01-L	

Note 1) Assembly of a bracket and set nuts

Note 2) □ in round pressure gauge part numbers indicates a pipe thread type. No indication is necessary for R; however, indicate N for NPT.

Please contact SMC regarding the pipe thread type NPT and the supply of pressure gauge with psi unit display specifications.

Note 3) Standard pressure gauge

## ⚠ Specific Product Precautions

Be sure to read this before handling the products. Refer to back page 50 for Safety Instructions and pages 387 to 391 for F.R.L. Precautions.

### Selection

#### ⚠ Warning

- Although exhaust of the residual pressure to the inlet side is possible when eliminating the inlet pressure, exhaust is not possible when the set pressure is 0.15 MPa or less. Use the regulator with backflow function.

### Maintenance

#### ⚠ Warning

- When using the regulator between a solenoid valve and an actuator, check the pressure gauge periodically. Sudden pressure fluctuations may shorten the durability of the pressure gauge. A digital pressure gauge is recommended for such situation or as deemed necessary.

### Mounting/Adjustment

#### ⚠ Warning

- Set the regulator while verifying the displayed values of the inlet and outlet pressure gauges. Turning the regulator knob excessively can cause damage to the internal parts.
- Do not use tools on the pressure regulator knob as this may cause damage. It must be operated manually.

#### ⚠ Caution

- Be sure to unlock the knob before adjusting the pressure and lock it after setting the pressure. Failure to follow this procedure can cause damage to the knob and the outlet pressure may fluctuate.
  - Pull the pressure regulator knob to unlock. (You can visually verify this with the "orange mark" that appears in the gap.)
  - Push the pressure regulator knob to lock. When the knob is not easily locked, turn it left and right a little and then push it (when the knob is locked, the "orange mark", i.e., the gap will disappear).
- Pulsation will be generated when the difference between the inlet and the outlet pressure is large. In this case, reduce the pressure difference between the inlet and the outlet. Please consult with SMC if the pulsation problem is not resolved.

AC-A  
 AF-A  
 AF-A  
 AR-A  
 AL-A  
 AW-A  
 AC-B  
 AF-A  
 AF-A  
 AR-A  
 AL-A  
 AW-A  
 AW-□  
 AF-G  
 E-□  
 AV  
 AF

# AR10-A to AR40-A Series

## Flow Rate Characteristics (Representative values)

Condition: Inlet pressure 0.7 MPa

**AR10-A**

M5

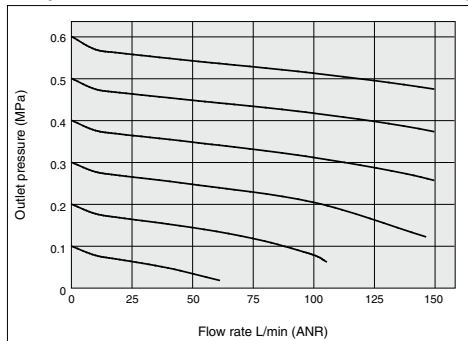

**AR20-A**

Rc1/4

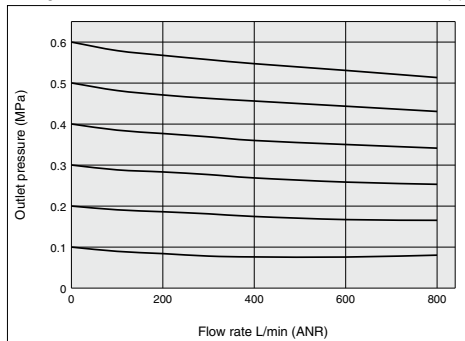

**AR25-A**

Rc3/8

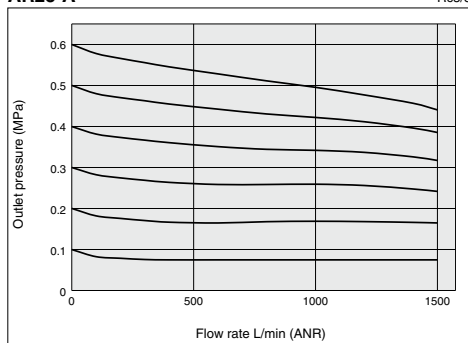

**AR30-A**

Rc3/8

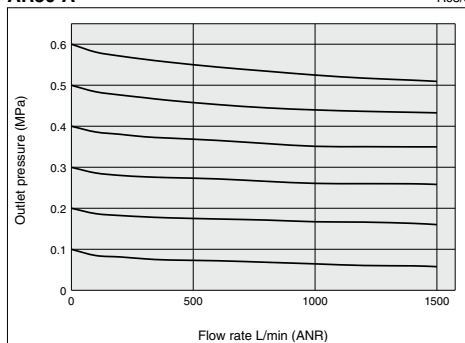

**AR40-A**

Rc1/2

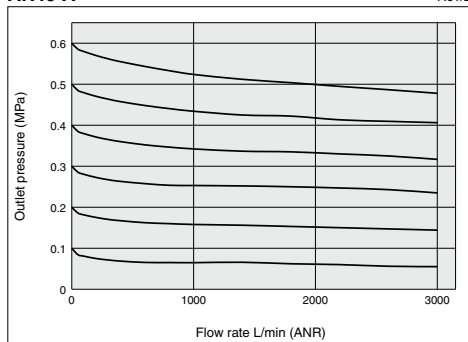

**AR40-06-A**

Rc3/4

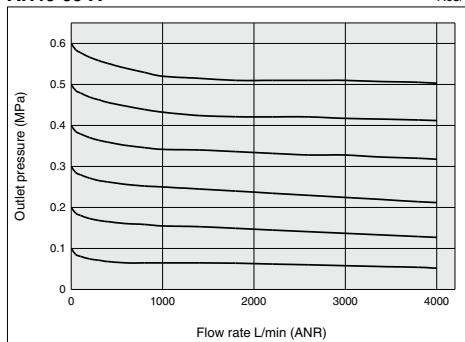

# Regulator **AR10-A to AR40-A Series**

## Pressure Characteristics (Representative values)

Conditions: Inlet pressure 0.7 MPa, Outlet pressure 0.2 MPa, Flow rate 20 L/min (ANR)

**AR10-A**

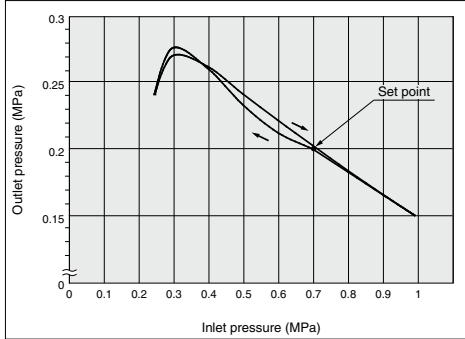

**AR20-A**

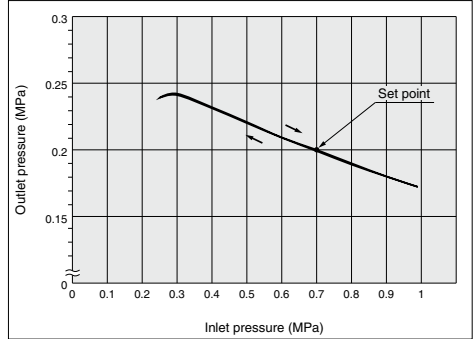

**AR25-A**

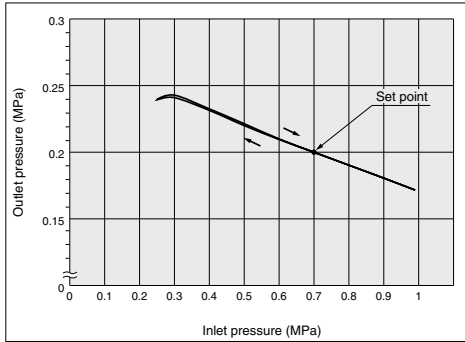

**AR30-A**

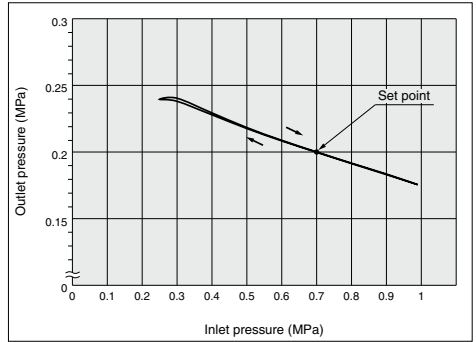

**AR40-A/AR40-06-A**

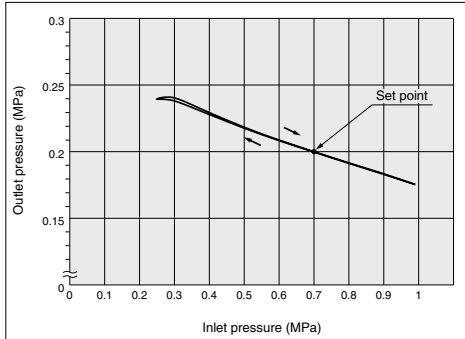

AC-A

AF-A

AF-A

AR-A

AL-A

AW-A

AC-B

AF-A

AF-A

AR-B

AL-A

AW-B

AW

AG

E

AV

AF

# AR10-A to AR40-A Series

## Construction

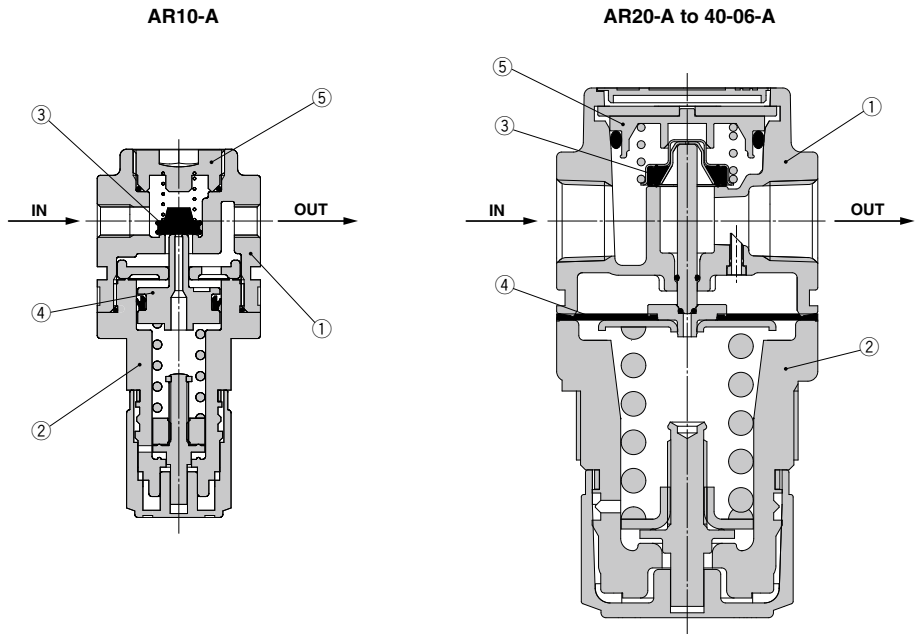

### Component Parts

No.	Description	Material	Model	Color
1	Body	Zinc die-cast	AR10-A	White
		Aluminum die-cast	AR20-A to AR40-A	
2	Bonnet	Polyacetal	AR10-A to AR40-A	White

### Replacement Parts

No.	Description	Material	Part no.				
			AR10-A	AR20-A	AR25-A	AR30-A	AR40-A
3	Valve assembly	Stainless steel, HNBR	AR10P-090S	AR22P-060AS	AR25P-060AS	AR32P-060AS	AR42P-060AS
4	Diaphragm assembly	Weatherable NBR	AR10P-150AS <sup>(Note)</sup>	AR22P-150AS	AR25P-150AS	AR32P-150AS	AR42P-150AS
5	Valve guide assembly	Polyacetal	131329	AR22P-050AS	AR25P-050AS	AR32P-050AS	AR42P-050AS

Note) The AR10-A is a piston type. Assembly of a piston and a seal (KSYP-13).

# Regulator **AR10-A to AR40-A Series**

## Dimensions

### AR10-A to AR40-06-A

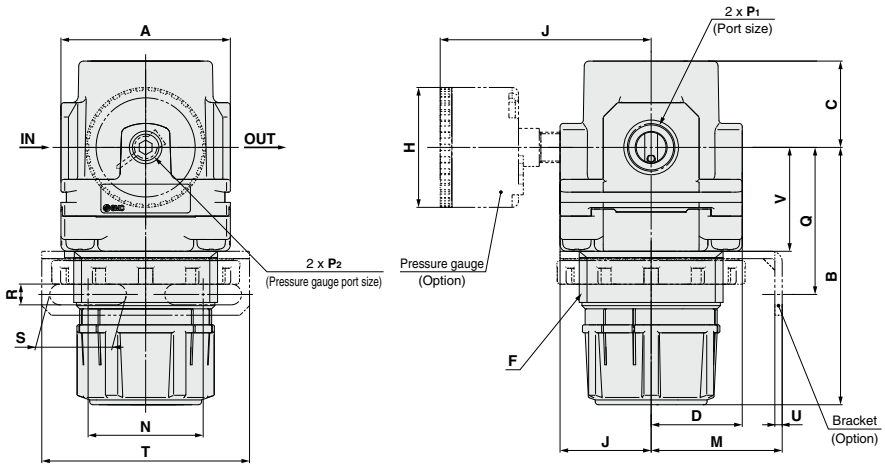

### Panel fitting dimensions

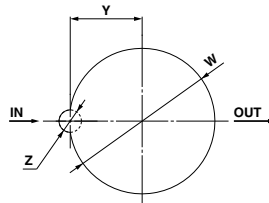

Plate thickness  
**AR10-A** : Max. 3.5  
**AR20-A to AR25-A** : Max. 4  
**AR30-A to AR40-06-A** : Max. 8

- AC-A
- AF-A
- AF□-A
- AR-A**
- AL-A
- AW-A
- AC-B
- AF-A
- AF□-A
- AR-B**
- AL-A
- AW-B
- AW□
- A□G
- E□
- AV
- AF

Model	Standard specifications																Optional specifications									
	P <sub>1</sub>	P <sub>2</sub>	A	B <sup>(Note)</sup>	C	D	F	J	Round type pressure gauge		Round type pressure gauge (with color zone)		Bracket mount						Panel mount							
									H	J	H	J	M	N	Q	R	S	T	U	V	W	Y	Z			
<b>AR10-A</b>	M5 x 0.8	1/16	25	47.4	11	12.5	M18 x 1	12.5	ø26	26	—	—	25	28	30	4.5	6.5	40	2	18	18.5	—	—			
<b>AR20-A</b>	1/8, 1/4	1/8	40	67.4	23.5	22	M36 x 1.5	22	ø37.5	58.5	ø37.5	59.5	30	34	43.9	5.4	15.4	55	2.3	27.3	36.5	17.5	6			
<b>AR25-A</b>	1/4, 3/8	1/8	53	70.4	23.5	22	M36 x 1.5	22	ø37.5	58.5	ø37.5	59.5	30	34	44.3	5.4	15.4	55	2.3	30.3	36.5	17.5	6			
<b>AR30-A</b>	1/4, 3/8	1/8	53	83.5	27	28.5	M45 x 1.5	28.5	ø37.5	65	ø37.5	66	41	36	46	6.5	24	65	2.3	32.5	45.5	22.5	7			
<b>AR40-A</b>	1/4, 3/8, 1/2	1/8	70	100	33.5	34.5	M52 x 1.5	34.5	ø42.5	72	ø42.5	72	50	38	54	8.5	26.5	70	2.3	38.4	52.5	26	7			
<b>AR40-06-A</b>	3/4	1/8	75	101.5	33.5	34.5	M52 x 1.5	34.5	ø42.5	72	ø42.5	72	50	38	55.5	8.5	26.5	70	2.3	39.9	52.5	26	7			

Note) The dimension of B is the length when the filter regulator knob is unlocked.

# Regulator/AR20-A to AR40-06-A

## Made to Order

Please contact SMC for detailed dimensions, specifications and lead times.



### ① 0.4 MPa Setting

The setting specification is 0.4 MPa. When a pressure gauge is included, the display will show a range from 0 to 0.7 MPa.

#### Specifications

Proof pressure	1.5 MPa
Maximum operating pressure	1.0 MPa
Set pressure range <small>Note 1)</small>	0.05 to 0.4 MPa

Note 1) Pressure can be set higher than the specification pressure in some cases, but use pressure within the specification range.

#### Applicable Model

Model	AR20-A	AR25-A	AR30-A	AR40-A	AR40-06-A
Port size	1/8, 1/4	1/4, 3/8	1/4, 3/8	1/4, 3/8, 1/2	3/4

AR 30 -   03   -   - A - X406

①
②
③
④
⑤
0.4 MPa setting

• Option/Semi-standard: Select one each for a to f.  
 • Option/Semi-standard symbol: When more than one specification is required, indicate in alphanumeric order.  
 Example) AR30-03BG-NR-A-X406

		Symbol	Description	① Body size				
				20	25	30	40	
②	Pipe thread type	Nil	Rc	●	●	●	●	
		N	NPT	●	●	●	●	
		F	G	●	●	●	●	
		+						
③	Port size	01	1/8	●	—	—	—	
		02	1/4	●	●	●	●	
		03	3/8	—	●	●	●	
		04	1/2	—	—	—	●	
		06	3/4	—	—	—	●	
		+						
④ Option (Note 2)	a Mounting	Nil	Without mounting option	●	●	●	●	
		B <small>Note 3)</small>	With bracket	●	●	●	●	
		H	With set nut (for panel mount) <small>Note 4)</small>	●	●	●	●	
		+						
④	b Pressure gauge	Nil	Without pressure gauge	●	●	●	●	
		G	Round type pressure gauge (with limit indicator)	●	●	●	●	
		M	Round type pressure gauge (with color zone)	●	●	●	●	
		+						
⑤ Semi-standard	c Exhaust mechanism	Nil	Relieving type	●	●	●	●	
		N	Non-relieving type	●	●	●	●	
			+					
	d Flow direction	Nil	Flow direction: Left to right	●	●	●	●	
		R	Flow direction: Right to left	●	●	●	●	
		+						
e Knob	Nil	Downward	●	●	●	●		
	Y	Upward	●	●	●	●		
		+						
f Pressure unit	Nil	Name plate and caution plate for bowl in imperial units: MPa	●	●	●	●		
	Z <small>Note 5)</small>	Name plate and caution plate for bowl in imperial units: psi	○ <small>Note 6)</small>	○ <small>Note 6)</small>	○ <small>Note 6)</small>	○ <small>Note 6)</small>		

Note 2) Option B, G, H, M are not assembled and supplied loose at the time of shipment.

Note 3) Assembly of a bracket and set nuts

Note 4) Only for the AR20-A to 40-A

Note 5) For pipe thread type: NPT

This product is for overseas use only according to the new Measurement Law. (The SI unit type is provided for use in Japan.)

Cannot be used with M: Round pressure gauge (with color zone). Available by request for special.

Note 6) ○: For pipe thread type: NPT only

# Regulator/AR20-A to AR40-06-A

## Made to Order

Please contact SMC for detailed dimensions, specifications and lead times.



### ② 0.85 MPa Setting

The maximum set pressure is 0.85 MPa. When a pressure gauge is included, the display will show a range from 0 to 1.0 MPa.

#### Specifications

Proof pressure	1.5 MPa
Maximum operating pressure	1.0 MPa
Set pressure range	0.05 to 0.85 MPa

#### Applicable Model

Model	AR20-A	AR25-A	AR30-A	AR40-A	AR40-06-A
Port size	1/8, 1/4	1/4, 3/8	1/4, 3/8	1/4, 3/8, 1/2	3/4

AR **30** - **03** - **03** - **03** - **A** - **X2068**

① ② ③ ④ ⑤ ⑥ 0.85 MPa setting

- Option/Semi-standard: Select one each for a to f.
- Option/Semi-standard symbol: When more than one specification is required, indicate in alphanumeric order.  
Example) AR30-03BG-NR-A-X2068

		Symbol	Description	① Body size			
				20	25	30	40
②	Pipe thread type	Nil	Rc	●	●	●	●
		N	NPT	●	●	●	●
		F	G	●	●	●	●
+							
③	Port size	01	1/8	●	—	—	—
		02	1/4	●	●	●	●
		03	3/8	—	●	●	●
		04	1/2	—	—	—	●
		06	3/4	—	—	—	●
+							
④ Option (Note 1)	a Mounting	Nil	Without mounting option	●	●	●	●
		B (Note 2)	With bracket	●	●	●	●
		H	With set nut (for panel mount) (Note 3)	●	●	●	●
+							
b	Pressure gauge	Nil	Without pressure gauge	●	●	●	●
		G	Round type pressure gauge (with limit indicator)	●	●	●	●
		M	Round type pressure gauge (with color zone)	●	●	●	●
+							
c	Exhaust mechanism	Nil	Relieving type	●	●	●	●
		N	Non-relieving type	●	●	●	●
+							
⑤ Semi-standard	d Flow direction	Nil	Flow direction: Left to right	●	●	●	●
		R	Flow direction: Right to left	●	●	●	●
+							
e	Knob	Nil	Downward	●	●	●	●
		Y	Upward	●	●	●	●
+							
f	Pressure unit	Nil	Name plate and caution plate for bowl in imperial units: MPa	●	●	●	●
		Z (Note 4)	Name plate and caution plate for bowl in imperial units: psi	○ (Note 5)	○ (Note 5)	○ (Note 5)	○ (Note 5)

Note 1) Option B, G, H, M are not assembled and supplied loose at the time of shipment.

Note 2) Assembly of a bracket and set nuts

Note 3) Only for the AR20-A to 40-A

Note 4) For pipe thread type: NPT

This product is for overseas use only according to the new Measurement Law. (The SI unit type is provided for use in Japan.)

Cannot be used with M: Round pressure gauge (with color zone). Available by request for special.

Note 5) ○: For pipe thread type: NPT only

AC-A

AF-A

AF□-A

AR-A

AL-A

AW-A

AC-B

AF-A

AF□-A

AR-B

AL-A

AW-B

AW□

AF□G

E□

AV

AF





# Modular Type Lubricator **AL Series**

Lubricator AL Series	Model	Port size	Option
 <p data-bbox="115 786 237 807">P.460 to 465</p>	<b>AL10-A</b>	M5 x 0.8	Bracket (Except AL10-A)
	<b>AL20-A</b>	1/8, 1/4	
	<b>AL30-A</b>	1/4, 3/8	
	<b>AL40-A</b>	1/4, 3/8, 1/2	
	<b>AL40-06-A</b>	3/4	
	<b>AL50-A</b>	3/4, 1	
	<b>AL60-A</b>	1	

- AC-A
- AF-A
- AF-A
- AR-A
- AL-A**
- AW-A
- AC-B
- AF-A
- AF-A
- AR-B
- AL-A
- AW-B
- AW
- AW
- AG
- E
- AV
- AF

# Lubricator

# AL10-A to AL60-A

Symbol

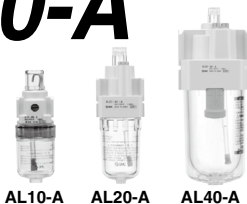

## How to Order

AL **30** - **03** **B** - **5** - A

①      ②      ③      ④      ⑤

- Option/Semi-standard: Select one each for a to d.
- Option/Semi-standard symbol: When more than one specification is required, indicate in alphanumeric order.  
Example) AL30-03B-3RW-A

	Symbol	Description	①						
			Body size						
			10	20	30	40	50	60	
②	Pipe thread type	Nil	Metric thread (M5)						
		N	Rc						
		F	NPT						
		G							
+									
③	Port size	M5	M5 x 0.8						
		01	1/8						
		02	1/4						
		03	3/8						
		04	1/2						
		06	3/4						
		10	1						
+									
④	Option (Mounting)	Nil	Without mounting option						
		B <small>Note 1)</small>	With bracket						
+									
⑤	a	Bowl <small>Note 2) 3)</small>	Nil	Polycarbonate bowl					
			2	Metal bowl					
			6	Nylon bowl					
			8	Metal bowl with level gauge					
			C	With bowl guard					
			6C	With bowl guard (Nylon bowl)					
	+								
	b	Lubricant exhaust port	Nil	Without drain cock					
			3	With drain cock					
			3W <small>Note 6)</small>	Drain cock with barb fitting					
	+								
	c	Flow direction	Nil	Flow direction: Left to right					
			R	Flow direction: Right to left					
	+								
	d	Pressure unit	Nil	Name plate and caution plate: MPa					
			Z <small>Note 7)</small>	Name plate and caution plate: psi, °F					
				○ <small>Note 8)</small>	○ <small>Note 8)</small>	○ <small>Note 8)</small>	○ <small>Note 8)</small>	○ <small>Note 8)</small>	○ <small>Note 8)</small>

Note 1) Option is not assembled and supplied loose at the time of shipment.

Note 2) Refer to Chemical data on page 463 for chemical resistance of the bowl.

Note 3) Refer to page 465-1 for 1000 cm<sup>3</sup> tanks.

Note 4) A bowl guard is provided as standard equipment (polycarbonate).

Note 5) A bowl guard is provided as standard equipment (nylon).

Note 6) The combination of metal bowl: 2 and 8 is not available.

Note 7) For pipe thread type: M5, NPT. This product is for overseas use only according to the new Measurement Law. (The SI unit type is provided for use in Japan.)

Note 8) ○: For pipe thread type: M5, NPT only

## Standard Specifications

Model	AL10-A	AL20-A	AL30-A	AL40-A	AL40-06-A	AL50-A	AL60-A
Port size	M5 x 0.8	1/8, 1/4	1/4, 3/8	1/4, 3/8, 1/2	3/4	3/4, 1	1
Fluid	Air						
Ambient and fluid temperature	-5 to 60°C (with no freezing)						
Proof pressure	1.5 MPa						
Maximum operating pressure	1.0 MPa						
Minimum dripping flow rate (L/min (ANR)) <sup>(Note)</sup>	4	15	1/4: 30 3/8: 40	1/4: 30 3/8: 40 1/2: 50	50	190	220
Oil capacity (cm <sup>3</sup> )	7	25	55	135			
Recommended lubricant	Class 1 turbine oil (ISO VG32)						
Bowl material	Polycarbonate						
Bowl guard	—	Semi-standard (Steel)	Standard (Polycarbonate)				
Weight (kg)	0.07	0.10	0.20	0.38	0.43	0.94	1.09

(Note) · The flow rate is 5 drops or greater/min under the following conditions: Inlet pressure of 0.5 MPa; Class 1 turbine oil (ISO VG32); Temperature at 20°C; Oil adjustment valve fully open.  
 · For a circuit that repeatedly turns ON and OFF on the outlet side, make the adjustment so that the average air consumption per minute becomes the minimum dripping flow rate or more.

## Option/Part No.

Optional specifications	Model						
	AL10-A	AL20-A	AL30-A	AL40-A	AL40-06-A	AL50-A	AL60-A
Bracket assembly <sup>(Note)</sup>	—	AF22P-050AS	AF32P-050AS	AF42P-050AS	AF42P-070AS	AF52P-050AS	

(Note) Assembly of a bracket and 2 mounting screws

## Bowl Assembly/Part No.

Bowl material	Lubricant exhaust port	Other	Model					
			AL10-A	AL20-A	AL30-A	AL40-A	AL40-06-A	AL50-A
Polycarbonate bowl	Without drain cock	—	C1SL-A	C2SL-A	—	—		
		With bowl guard	—	C2SL-C-A	C3SL-A	C4SL-A		
	With drain cock	—	C1SL-3-A	C2SL-3-A	—	—		
		With bowl guard	—	C2SL-3C-A	C3SL-3-A	C4SL-3-A		
Drain cock with barb fitting	With bowl guard	—	—	C3SL-3W-A	C4SL-3W-A			
Nylon bowl	Without drain cock	—	C1SL-6-A	C2SL-6-A	—	—		
		With bowl guard	—	C2SL-6C-A	C3SL-6-A	C4SL-6-A		
	With drain cock	—	C1SL-36-A	C2SL-36-A	—	—		
		With bowl guard	—	C2SL-36C-A	C3SL-36-A	C4SL-36-A		
Drain cock with barb fitting	With bowl guard	—	—	C3SL-36W-A	C4SL-36W-A			
Metal bowl	Without drain cock	—	C1SL-2-A	C2SL-2-A	C3SL-2-A	C4SL-2-A		
		With level gauge	—	—	C3LL-8-A	C4LL-8-A		
	With drain cock	—	C1SL-23-A	C2SL-23-A	C3SL-23-A	C4SL-23-A		
		With level gauge	—	—	C3LL-38-A	C4LL-38-A		

(Note) · Bowl assembly for the AL20-A to AL60-A models comes with a bowl seal.  
 · Please consult with SMC separately for psi and °F unit display specifications.

AC-A  
 AF-A  
 AF□-A  
 AR-A  
 AL-A  
 AW-A  
 AC-B  
 AF-A  
 AF□-A  
 AR-  
 AL-A  
 AW-  
 AW□  
 AF-G  
 E□  
 AV  
 AF

# AL10-A to AL60-A Series

## Flow Rate Characteristics (Representative values)

**AL10-A**

M5

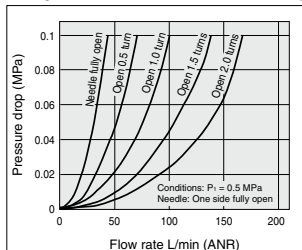

**AL20-A**

Rc1/4

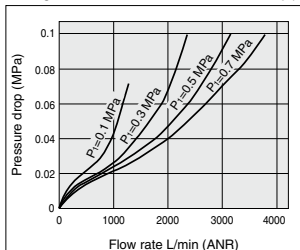

**AL30-A**

Rc3/8

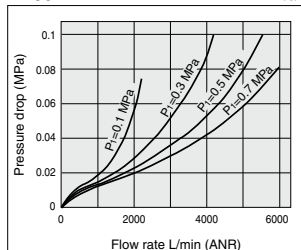

**AL40-A**

Rc1/2

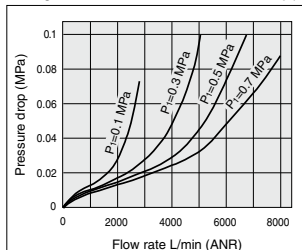

**AL40-06-A**

Rc3/4

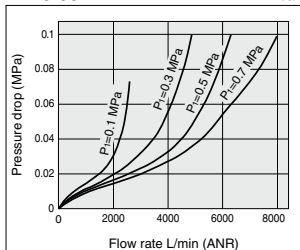

**AL50-A**

Rc1

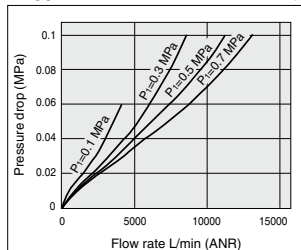

**AL60-A**

Rc1

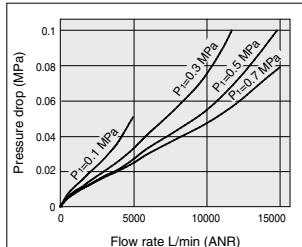

## Working Principle: AL10 Type

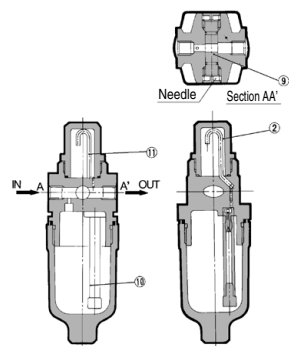

A portion of the air introduced from the IN side pressurizes the lubricant inside the bowl. The remainder of the air passes through the needle (9), and flows to the OUT side. The differential pressure between the inside of the bowl and the inside of the sight dome (2), causes the lubricant inside the bowl into the oil passage (10). The lubricant drips from the dripping tube (11), and lubricates the OUT side. The amount of lubricant is adjusted by the needle (9) on the front face. Turning the needle clockwise increases the amount of the lubricant, and turning it counterclockwise until fully open shuts off the lubricant. The needle on the side that is not used should be left fully open.

**⚠ Specific Product Precautions**

**Be sure to read this before handling the products. Refer to back page 50 for Safety Instructions and pages 387 to 391 for F.R.L. Precautions.**

**Selection**

**⚠ Warning**

- Do not introduce air from the outlet side as this can damage the bumper.
- The standard bowl for the air filter, filter regulator, and lubricator, as well as the sight dome for the lubricator are made of polycarbonate. Do not use in an environment where they are exposed to or come in contact with organic solvents, chemicals, cutting oil, synthetic oil, alkali, and thread lock solutions.

**Effects of atmosphere of organic solvents and chemicals, and where these elements are likely to adhere to the equipment.**

**Chemical data for substances causing degradation (Reference)**

Type	Chemical name	Application examples	Material	
			Polycarbonate	Nylon
Acid	Hydrochloric acid Sulfuric acid, Phosphoric acid Chromic acid	Acid washing liquid for metals	△	×
Alkaline	Sodium hydroxide (Caustic soda) Potash Calcium hydroxide (Slack lime) Ammonia water Carbonate of soda	Degreasing of metals Industrial salts Water-soluble cutting oil	×	○
Inorganic salts	Sodium sulfide Sulfate of potash Sulfate of soda	—	×	△
Chlorine solvents	Carbon tetrachloride Chloroform Ethylene chloride Methylene chloride	Cleansing liquid for metals Printing ink Dilution	×	△
Aromatic series	Benzene Toluene Paint thinner	Coatings Dry cleaning	×	△
Ketone	Acetone Methyl ethyl ketone Cyclohexane	Photographic film Dry cleaning Textile industries	×	×
Alcohol	Ethyl alcohol IPA Methyl alcohol	Antifreeze Adhesives	△	×
Oil	Gasoline Kerosene	—	×	○
Ester	Phthalic acid dimethyl Phthalic acid diethyl Acetic acid	Synthetic oil Anti-rust additives	×	○
Ether	Methyl ether Ethyl ether	Brake oil additives	×	○
Amino	Methyl amino	Cutting oil Brake oil additives Rubber accelerator	×	×
Others	Thread-lock fluid Seawater Leak tester	—	×	△

○: Essentially safe △: Some effects may occur. ×: Effects will occur.

When the above factors are present, or there is some doubt, use a metal bowl for safety.

**Selection**

**⚠ Caution**

- Use a check valve (AKM series) to prevent back flow of the lubricant when redirecting the air flow before the lubricator.

**Maintenance**

**⚠ Warning**

- For the AL10-A/AL20-A type, replenish the lubricant after releasing the inlet pressure. Lubrication cannot take place under a pressurized condition.
- Adjustment of the oil regulating valve for models from the AL20-A to AL60-A should be carried out manually. Turning it counterclockwise increases the dripping amount, and turning it clockwise reduces the dripping amount. The use of tools etc. can result in damage to the unit. From the fully closed position, three rotations will bring it to the fully open position. Do not rotate it any further than this. Note that the numbered scale markings are guidelines for adjusting the position, and not indicators of the dripping amount.

**⚠ Caution**

- Check the dripping amount once a day. Drip failure can cause damage to the components that need lubrication.

**Mounting/Adjustment**

**⚠ Caution**

- When the bowl is installed on the AL30-A to AL60-A, install them so that the lock button lines up to the groove of the front (or the back) of the body to avoid drop or damage of the bowl.

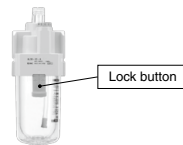

AC-A  
AF-A  
AF-A  
AR-A  
AL-A  
AW-A  
AC-B  
AF-A  
AF-A  
AR-A  
AL-A  
AW-A  
AW-  
AC-G  
E-  
AV  
AF

# AL10-A to AL60-A Series

## Construction

AL10-A

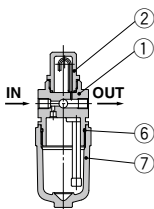

AL20-A

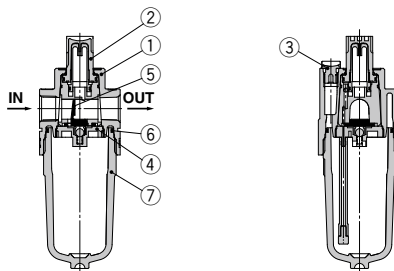

AL30-A/AL40-A

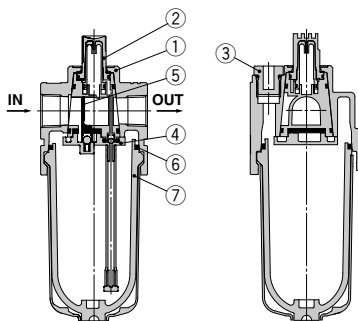

AL50-A/AL60-A

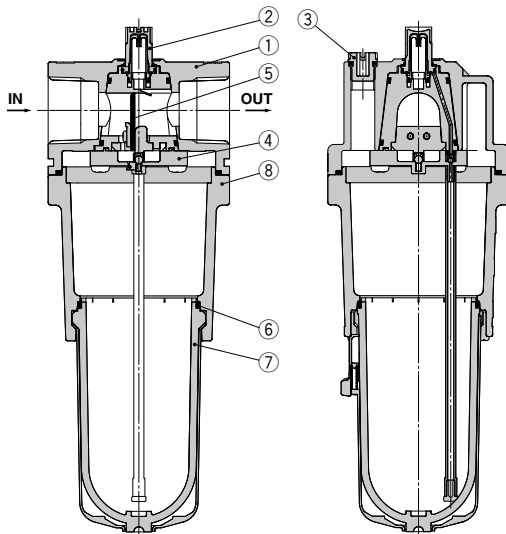

### Component Parts

No.	Description	Material	Model	Color
1	Body	Zinc die-cast	AL10-A	White
		Aluminum die-cast	AL20-A to AL60-A	
8	Housing	Aluminum die-cast	AL50-A/AL60-A	White

### Replacement Parts

No.	Description	Material	Part no.						
			AL10-A	AL20-A	AL30-A	AL40-A	AL40-06-A	AL50-A	AL60-A
2	Sight dome assembly	Polycarbonate	AL10P-080AS	AL20P-080AS					
3	Lubrication plug assembly	—	—	AL22P-060AS	AL32P-060AS	AL42P-060AS			
4	Bumper retainer assembly	—	—	AL20P-030AS	AL30P-030AS	AL40P-030AS	AL50P-030AS	AL60P-030AS	
5	Bumper (assembly)	Synthetic resin	—	AL20P-040S	AL30P-040S	AL40P-040S	AL50P-040AS	AL60P-040AS	
6	Bowl seal	NBR	C1SFP-260S	C2SFP-260S	C32FP-260S	C42FP-260S			
7	Bowl assembly <sup>(Note)</sup>	Polycarbonate	C1SL-A	C2SL-A	C3SL-A	C4SL-A			

(Note) . Bowl seal is included for the AL20-A to AL60-A. Please consult with SMC separately for psi and °F unit display specifications.

. Bowl assembly for the AL30-A to AL60-A models comes with a bowl guard (Material: Polycarbonate).

## Dimensions

### AL10-A

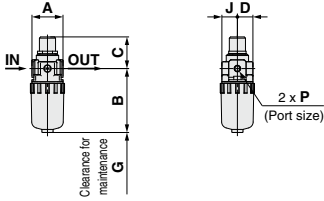

### AL20-A

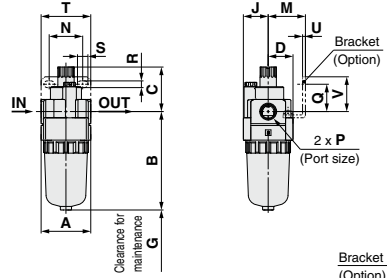

### AL30-A to AL40-06-A

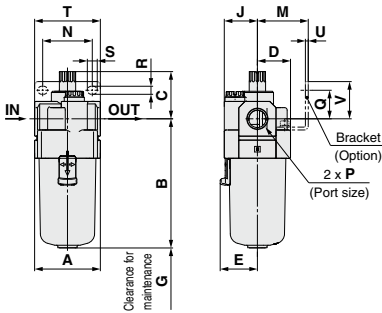

### AL50-A AL60-A

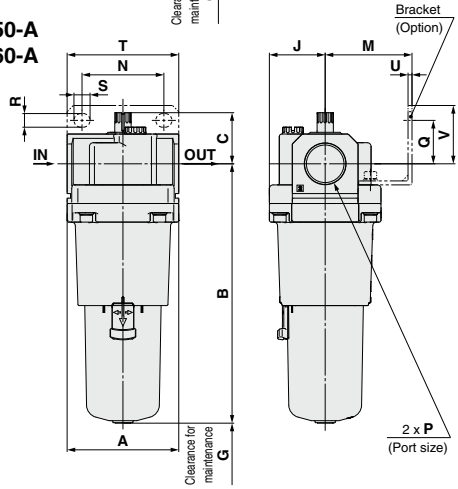

Applicable model	AL10-A/AL20-A			AL30-A to AL60-A	
Optional/Semi-standard specifications	With drain cock	Metal bowl	Metal bowl with drain cock	Metal bowl	
Dimensions					

Applicable model	AL30-A to AL60-A					
Optional/Semi-standard specifications	With drain cock	Metal bowl with level gauge	Metal bowl with drain cock	Metal bowl with level gauge, with drain cock	Drain cock with barb fitting	
Dimensions						

Model	Standard specifications																Optional specifications								Semi-standard specifications					
																	Bracket mount								With drain cock	With barb fitting	Metal bowl	Metal bowl with drain cock	Metal bowl with level gauge	Metal bowl with level gauge, with drain cock
	P	A	B	C	D	E	G	J	M	N	Q	R	S	T	U	V	B	B	B	B	B	B								
AL10-A	M5 x 0.8	25	51.5	25.5	12.5	—	35	12.5	—	—	—	—	—	—	—	59.9	—	56.3	59.3	—	—									
AL20-A	1/8, 1/4	40	79.3	35.9	20	—	60	20	27	22	5.4	8.4	40	2.3	28	87.7	—	84.5	87.5	—	—									
AL30-A	1/4, 3/8	53	104.1	38.1	26.7	30	80	26.7	41	35	23	6.5	13	53	2.3	30	115.1	123.6	104.1	117.6	124.1	137.6								
AL40-A	1/4, 3/8, 1/2	70	136.1	39.8	35.5	38.4	110	35.5	50	52	26	8.5	12.5	70	2.3	35	147.1	155.6	136.1	149.6	156.1	169.6								
AL40-06-A	3/4	75	138.1	37.8	35.5	38.4	110	35.5	50	52	25	8.5	12.5	70	2.3	34	149.1	157.6	138.1	151.6	158.1	171.6								
AL50-A	3/4, 1	90	209.1	41.2	45	—	110	45	70	66	35	11	13	90	3.2	47	220.1	228.6	209.1	222.6	229.1	246.2								
AL60-A	1	95	223.1	44.7	47.5	—	110	47.5	70	66	35	11	13	90	3.2	47	234.1	242.6	223.1	236.6	243.1	256.6								

- AC-A
- AF-A
- AF□-A
- AR-A
- AL-A
- AW-A
- AC-B
- AF-A
- AF□-A
- AR-A
- AL-A
- AW-B
- AW□
- A□G
- E□
- AV
- AF

# Semi-standard Specifications: 1000 cm<sup>3</sup> Tank Lubricator: **AL30 to AL60**

Available for previous models (AL30 to 60).

Symbol

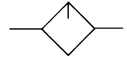

## How to Order

**AL** **30** - **03** **B** - **1**

① ② ③ ④ ⑤

• Option/Semi-standard: Select one each for a to c.  
• Option/Semi-standard symbol: When more than one specification is required, indicate in alphanumeric order.  
Example) AL30-03B-1R

	Symbol	Description	① Body size				
			30	40	50	60	
② Pipe thread type	Nil	Rc	●	●	●	●	
	N	NPT	●	●	●	●	
	F	G	●	●	●	●	
+							
③ Port size	02	1/4	●	●	—	—	
	03	3/8	●	●	—	—	
	04	1/2	—	●	—	—	
	06	3/4	—	●	●	—	
	10	1	—	—	●	●	
+							
④ Option (Mounting)	Nil	Without mounting option	●	●	●	●	
	B <sup>Note 1)</sup>	With bracket	●	●	●	●	
+							
⑤ Semi-standard	a Bowl <sup>Note 2)</sup>	1	1000 cm <sup>3</sup> tank	●	●	●	●
		10	1000 cm <sup>3</sup> tank (with switch) Lowest limit ON	●	●	●	●
		11	1000 cm <sup>3</sup> tank (with switch) Lowest limit OFF	●	●	●	●
	+						
b Flow direction	Nil	Flow direction: Left to right	●	●	●	●	
	R	Flow direction: Right to left	●	●	●	●	
+							
c Pressure unit	Nil	Name plate and caution plate for bowl in SI units: MPa	●	●	●	●	
	Z <sup>Note 3)</sup>	Name plate and caution plate for bowl in imperial units: psi, °F	○ <sup>Note 4)</sup>	○ <sup>Note 4)</sup>	○ <sup>Note 4)</sup>	○ <sup>Note 4)</sup>	

Note 1) Option B is not assembled and supplied loose at the time of shipment.

Note 2) The standard bowl is a metal bowl with level gauge and lubricant discharge function. The material of the sight dome is polycarbonate resin. For chemical resistance, refer to the chemical data on page 463.

Note 3) For pipe thread type: M5, NPT. This product is for overseas use only according to the new Measurement Act. (The SI unit type is provided for use in Japan.)

Note 4) ○: For pipe thread type: M5, NPT only

## Semi-standard/Bowl Assembly Part No.

Semi-standard specifications			Model				
Bowl material	With switch		AL30	AL40	AL40-06	AL50	AL60
	Lowest limit ON	Lowest limit OFF					
1000 cm <sup>3</sup> tank (Metal bowl with level gauge)	—	—	121538-1A				
	●	—	121538-1A-S1 [IS400-1 (Float switch only)]				
	—	●	121538-1A-S2 [IS400-2 (Float switch only)]				

Note) • It is not possible to switch from a polycarbonate, nylon or metal bowl, or from a metal bowl with level gauge to a 1000 cm<sup>3</sup> tank. Please order the product separately.

• When adding a float switch to the 1000 cm<sup>3</sup> tank, select IS400-1 or IS400-2.

• For other replacement parts, refer to the Operation Manual.



## Dimensions

Semi-standard specifications: 1000 cm<sup>3</sup> tank

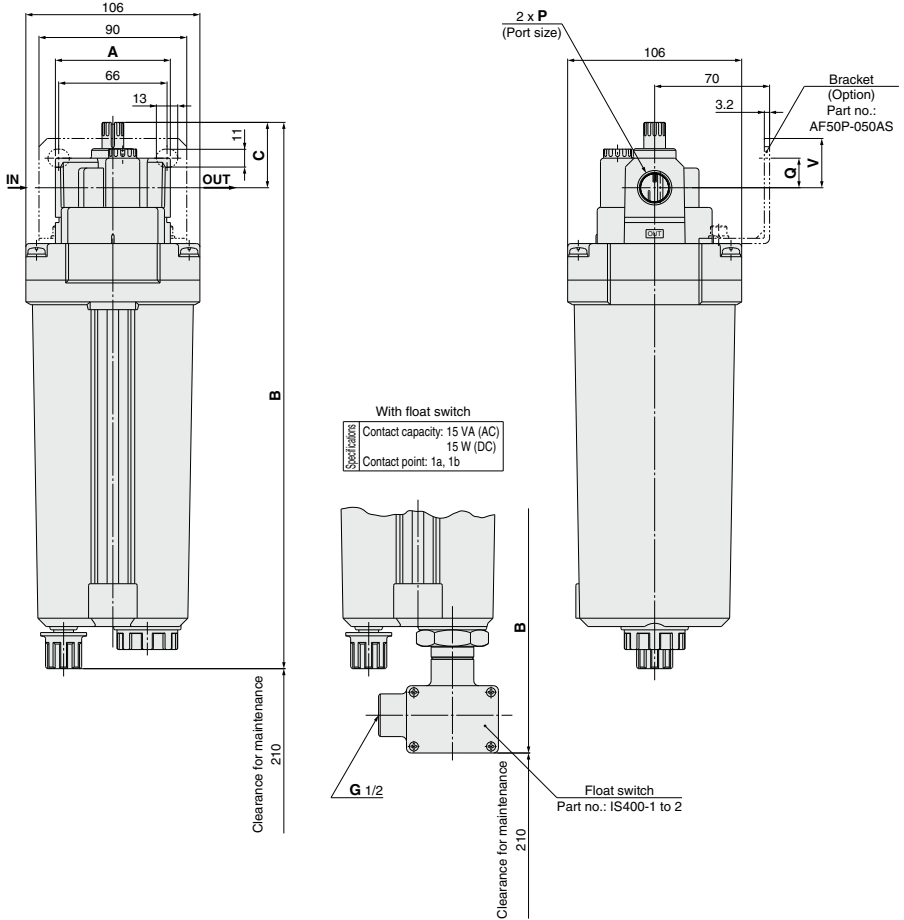

- AC-A
- AF-A
- AF□-A
- AR-A
- AL-A**
- AW-A
- AC-B
- AF-A
- AF□-A
- AR-B
- AL-A
- AW-B
- AW□
- A□G
- E□
- AV
- AF

Model	P	A	B	C	Bracket mount		Float switch
					Q	V	B
AL30	1/4, 3/8	53	324	38	25	—	374
AL40	1/4, 3/8, 1/2	70	333	40	18	—	383
AL40-06	3/4	75	333	38	16	—	383
AL50	3/4, 1	90	332	41	35	47	382
AL60	1	95	335	45	35	47	385



# Modular Type Filter Regulator **AW Series**

<b>Filter Regulator AW Series</b>    <b>P.468 to 479</b>	Model	Port size	Options
	<b>AW10-A</b>	M5 x 0.8	Bracket
	<b>AW20-A</b>	1/8, 1/4	Float type auto drain
	<b>AW30-A</b>	1/4, 3/8	Round type pressure gauge
	<b>AW40-A</b>	1/4, 3/8, 1/2	Set nut (for panel mount)*
	<b>AW40-06-A</b>	3/4	* For AW20-A to AW40-06-A, panel fitting dimensions are different from those of the current AW series.

## Made to Order

①	<b>0.4 MPa Setting (-X406)</b> The maximum set pressure is 0.4 MPa. When a pressure gauge is included, the display will show a range from 0 to 0.7 MPa.	<b>P.476 to 479</b>
②	<b>Long Bowl (-X64)</b> Drain capacity is greater than that of standard models.	
③	<b>0.85 MPa Setting (-X2068)</b> The maximum set pressure is 0.85 MPa. When a pressure gauge is included, the display will show a range from 0 to 1.0 MPa.	

AC-A  
 AF-A  
 AF□-A  
 AR-A  
 AL-A  
**AW-A**  
 AC-B  
 AF-A  
 AF□-A  
 AR-**B**  
 AL-A  
 AW-**B**  
 AW□  
 AF-G  
 E□  
 AV  
 AF

# Filter Regulator

# AW10-A to AW40-A

Symbol  
Filter Regulator

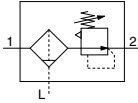

• Integrated filter and regulator units save space and require less piping.

## How to Order

AW **30** - **03** **BG** - **A** -

① ② ③ ④ ⑤

• Option/Semi-standard: Select one each for a to i.  
• Option/Semi-standard symbol: When more than one specification is required, indicate in alphanumeric order.  
Example) AW30-03BG-1N-A

• Made to Order  
(Refer to pages 476 to 479 for details.)

		Symbol	Description	①				
				Body size				
				10	20	30	40	
②	Pipe thread type	Nil	Metric thread (M5)	●	—	—	—	
		N <small>Note 1)</small>	Rc	—	●	●	●	
		F <small>Note 2)</small>	NPT	—	●	●	●	
			G	—	●	●	●	
+								
③	Port size	M5	M5	●	—	—	—	
		01	1/8	—	●	—	—	
		02	1/4	—	●	—	●	
		03	3/8	—	—	●	●	
		04	1/2	—	—	—	●	
		06	3/4	—	—	—	●	
+								
④ <small>Note 3)</small>	a	Mounting	Nil	Without mounting option	●	●	●	●
			B <small>Note 4)</small>	With bracket	●	●	●	●
			H	With set nut (for panel mount)	●	●	●	●
	+							
	b	Float type auto drain	Nil	Without auto drain	●	●	●	●
			C <small>Note 5)</small>	N.C. (Normally closed) Drain port is closed when pressure is not applied.	●	●	●	●
			D <small>Note 6)</small>	N.O. (Normally open) Drain port is open when pressure is not applied.	—	—	●	●
	+							
	c	Pressure gauge <small>Note 7)</small>	Nil	Without pressure gauge	●	●	●	●
			G	Round type pressure gauge (without limit indicator)	●	—	—	—
			M	Round type pressure gauge (with limit indicator)	—	●	●	●
	+							
⑤ <small>Note 8)</small>	d	Set pressure	Nil	0.05 to 0.7 MPa setting	●	●	●	●
			1	0.02 to 0.2 MPa setting	●	●	●	●
	+							
	e	Bowl <small>Note 9)</small>	Nil	Polycarbonate bowl	●	●	●	●
			2	Metal bowl	●	●	●	●
			6	Nylon bowl	●	●	●	●
			8	Metal bowl with level gauge	—	—	●	●
			C	With bowl guard	—	—	— <small>Note 10)</small>	— <small>Note 10)</small>
			6C	With bowl guard (Nylon bowl)	—	●	— <small>Note 11)</small>	— <small>Note 11)</small>

# Filter Regulator **AW10-A to AW40-A Series**

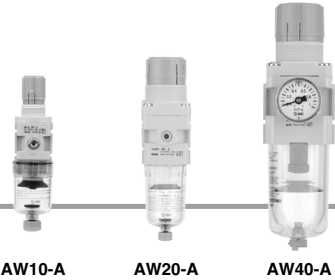

AW10-A

AW20-A

AW40-A

		Symbol	Description	①					
				Body size					
				10	20	30	40		
5	Semi-standard	f	Drain port <sup>Note 12)</sup>	Nil	With drain cock	●	●	●	●
			J <sup>Note 13)</sup>	Drain guide 1/8	—	●	—	—	
				Drain guide 1/4	—	—	●	●	
			W <sup>Note 14)</sup>	Drain cock with barb fitting (for ø6 x ø4 nylon tube)	—	—	—	●	●
	g	Exhaust mechanism	Nil	Relieving type	●	●	●	●	
			N	Non-relieving type	●	●	●	●	
	h	Flow direction	Nil	Flow direction: Left to right	●	●	●	●	
			R	Flow direction: Right to left	●	●	●	●	
	i	Pressure unit	Nil	Name plate, caution plate for bowl, and pressure gauge in imperial units: MPa	●	●	●	●	
			Z <sup>Note 15)</sup>	Name plate, caution plate for bowl, and pressure gauge in imperial units: psi, °F	○ <sup>Note 16)</sup>	○ <sup>Note 16)</sup>	○ <sup>Note 16)</sup>	○ <sup>Note 16)</sup>	

Note 1) Drain guide is NPT1/8 (applicable to the AW20-A) and NPT1/4 (applicable to the AW30-A to AW40-A). The auto drain port comes with ø3/8" One-touch fitting (applicable to the AW30-A to AW40-A).

Note 2) Drain guide is G1/8 (applicable to the AW20-A) and G1/4 (applicable to the AW30-A to AW40-A).

Note 3) Option B, G, H, M are not assembled and supplied loose at the time of shipment.

Note 4) Assembly of a bracket and set nuts

Note 5) When pressure is not applied, condensate which does not start the auto drain mechanism will be left in the bowl. Releasing the residual condensate before ending operations for the day is recommended.

Note 6) If the compressor is small (0.75 kW, discharge flow is less than 100 L/min[ANR]), air leakage from the drain cock may occur during start of operations. N.C. type is recommended.

Note 7) When the pressure gauge is attached, a 1.0 MPa pressure gauge will be fitted for standard (0.7 MPa) type. 0.4 MPa pressure gauge for 0.2 MPa type (1.0 MPa pressure gauge only for the AW10-A).

Note 8) Pressure can be set higher than the specification pressure in some cases, but use pressure within the specification range.

Note 9) Refer to Chemical data on page 471 for chemical resistance of the bowl.

Note 10) A bowl guard is provided as standard equipment (polycarbonate).

Note 11) A bowl guard is provided as standard equipment (nylon).

Note 12) The combination of float type auto drain: C and D is not available.

Note 13) Without a valve function

Note 14) The combination of metal bowl: 2 and 8 is not available.

Note 15) For pipe thread type: NPT. This product is for overseas use only according to the new Measurement Law. (The SI unit type is provided for use in Japan.) Cannot be used with M: Round pressure gauge (with color zone). Available by request for special.

Note 16) ○: For pipe thread type: M5, NPT only

## Standard Specifications

Model	AW10-A	AW20-A	AW30-A	AW40-A	AW40-06-A
Port size	M5 x 0.8	1/8, 1/4	1/4, 3/8	1/4, 3/8, 1/2	3/4
Pressure gauge port size	1/16 <sup>Note)</sup>			1/8	
Fluid	Air				
Ambient and fluid temperature	-5 to 60°C (with no freezing)				
Proof pressure	1.5 MPa				
Maximum operating pressure	1.0 MPa				
Set pressure range	0.05 to 0.7 MPa				
Nominal filtration rating	5 µm				
Drain capacity (cm <sup>3</sup> )	2.5	8	25		45
Bowl material	Polycarbonate				
Bowl guard	—	Semi-standard (Steel)	Standard (Polycarbonate)		
Construction	Relieving type				
Weight (kg)	0.09	0.21	0.41	0.75	0.81

Note) Use a bushing (part no: 131368) when connecting the R1/8 pressure gauge to the Rc1/16.

- AC-A
- AF-A
- AF-A
- AR-A
- AL-A
- AW-A
- AC-B
- AF-A
- AF-A
- AR-A
- AL-A
- AW-A
- AW
- AG
- E
- AV
- AF

# AW10-A to AW40-A Series

## Options/Part No.

Optional specifications			Model				
			AW10-A	AW20-A	AW30-A	AW40-A	AW40-06-A
Bracket assembly <sup>Note 1)</sup>			AR12P-270AS	AR22P-270AS	AR32P-270AS	AR42P-270AS	
Set nut			AR12P-260S	AR22P-260S	AR32P-260S	AR42P-260S	
Pressure <sup>Note 2)</sup> gauge	Round type	Standard	G27-10-R1	G36-10-□01		G46-10-□01	
		0.02 to 0.2 MPa setting	G27-10-R1 <sup>Note 3)</sup>	G36-4-□01		G46-4-□01	
	Round type (with color zone)	Standard	—	G36-10-□01-L		G46-10-□01-L	
		0.02 to 0.2 MPa setting	—	G36-4-□01-L		G46-4-□01-L	

Note 1) Assembly of a bracket and set nuts

Note 2) □ in round pressure gauge part numbers indicates a pipe thread type. No indication is necessary for R; however, indicate N for NPT.

Please contact SMC regarding the pipe thread type NPT and the supply of pressure gauge with psi unit display specifications.

Note 3) Standard pressure gauge

## Bowl Assembly/Part No.

Bowl material	Drain discharge mechanism	Drain port	Other	Model					
				AW10-A	AW20-A	AW30-A	AW40-A	AW40-06-A	
Polycarbonate bowl	Manual discharge	With drain cock	—	C1SF-A	C2SF-A	—	—		
		Drain cock with barb fitting	With bowl guard	—	C2SF-C-A	C3SF-A	C4SF-A		
		With drain guide (without valve function)	With bowl guard	—	C2SF□-J-A	C3SF-W-A	C4SF-W-A		
		With drain guide (without valve function)	With bowl guard	—	C2SF□-CJ-A	C3SF□-J-A	C4SF□-J-A		
	Automatic discharge <sup>Note 2)</sup> (Auto drain)	Normally closed (N.C.)	With bowl guard	—	AD17-A	AD27-A	—	—	
		Normally open (N.O.)	With bowl guard	—	—	AD37□-A	AD38□-A	AD47□-A	
Nylon bowl	Manual discharge	With drain cock	—	C1SF-6-A	C2SF-6-A	—	—		
		Drain cock with barb fitting	With bowl guard	—	C2SF-6C-A	C3SF-6-A	C4SF-6-A		
		With drain guide (without valve function)	With bowl guard	—	—	C3SF-6W-A	C4SF-6W-A		
		With drain guide (without valve function)	With bowl guard	—	C2SF□-6J-A	—	—		
	Automatic discharge <sup>Note 2)</sup> (Auto drain)	Normally closed (N.C.)	With bowl guard	—	AD17-6-A	AD27-6-A	—	—	
		Normally open (N.O.)	With bowl guard	—	—	AD37□-6-A	AD38□-6-A	AD47□-6-A	
Metal bowl	Manual discharge	With drain cock	With level gauge	—	C1SF-2-A	C2SF-2-A	C3SF-2-A	C4SF-2-A	
		With drain guide (without valve function)	With level gauge	—	—	C3LF-8-A	C4LF-8-A		
		With drain guide (without valve function)	With level gauge	—	—	C2SF□-2J-A	C3SF□-2J-A	C4SF□-2J-A	
		With drain guide (without valve function)	With level gauge	—	—	C3LF□-8J-A	C4LF□-8J-A		
	Automatic discharge <sup>Note 2)</sup> (Auto drain)	Normally closed (N.C.)	With level gauge	—	AD17-2-A	AD27-2-A	AD37□-2-A	AD47□-2-A	
		Normally open (N.O.)	With level gauge	—	—	AD37□-8-A	AD38□-2-A	AD47□-8-A	
			With level gauge	—	—	AD38□-8-A	AD48□-2-A		
			With level gauge	—	—	AD38□-8-A	AD48□-8-A		

Note) Minimum operating pressure: N.O. type—0.1 MPa (AD38-A, AD48-A); N.C. type—0.1 MPa (AD17-A, AD27-A) and 0.15 MPa (AD37-A, AD47-A).

Bowl assembly for the AW10-A to AW40-06-A models comes with a bowl seal.

□ in bowl assembly part numbers indicates a pipe thread type (applicable tubing for auto drain).

No indication is necessary for Rc thread; however, indicate N for NPT thread, and F for G thread. (For auto drain, Nil: ø10, N: ø3/8")

Please consult with SMC separately for psi and °F unit display specifications.

## ⚠ Specific Product Precautions

Be sure to read this before handling the products. Refer to back page 50 for Safety Instructions and pages 387 to 391 for F.R.L. Precautions.

### Design/Selection

#### ⚠ Warning

- Although exhaust of the residual pressure to the inlet side is possible when eliminating the inlet pressure, exhaust is not possible when the set pressure is 0.15 MPa or less. Use the regulator with backflow function.
- The standard bowl for the air filter, filter regulator, and lubricator, as well as the sight dome for the lubricator are made of polycarbonate. Do not use in an environment where they are exposed to or come in contact with organic solvents, chemicals, cutting oil, synthetic oil, alkali, and thread lock solutions.

Effects of atmosphere of organic solvents and chemicals, and where these elements are likely to adhere to the equipment.  
Chemical data for substances causing degradation (Reference)

Type	Chemical name	Application examples	Material	
			Polycarbonate	Nylon
Acid	Hydrochloric acid Sulfuric acid, Phosphoric acid Chromic acid	Acid washing liquid for metals	△	×
Alkaline	Sodium hydroxide (Caustic soda) Potash Calcium hydroxide (Slack lime) Ammonia water Carbonate of soda	Degreasing of metals Industrial salts Water-soluble cutting oil	×	○
Inorganic salts	Sodium sulfide Sulfate of potash Sulfate of soda	—	×	△
Chlorine solvents	Carbon tetrachloride Chloroform Ethylene chloride Methylene chloride	Cleansing liquid for metals Printing ink Dilution	×	△
Aromatic series	Benzene Toluene Paint thinner	Coatings Dry cleaning	×	△
Ketone	Acetone Methyl ethyl ketone Cyclohexane	Photographic film Dry cleaning Textile industries	×	×
Alcohol	Ethyl alcohol IPA Methyl alcohol	Antifreeze Adhesives	△	×
Oil	Gasoline Kerosene	—	×	○
Ester	Phthalic acid dimethyl Phthalic acid diethyl Acetic acid	Synthetic oil Anti-rust additives	×	○
Ether	Methyl ether Ethyl ether	Brake oil additives	×	○
Amino	Methyl amino	Cutting oil Brake oil additives Rubber accelerator	×	×
Others	Thread-lock fluid Seawater Leak tester	—	×	△

○: Essentially safe △: Some effects may occur. ×: Effects will occur.

When the above factors are present, or there is some doubt, use a metal bowl for safety.

### Maintenance

#### ⚠ Warning

- Replace the element every 2 years or when the pressure drop becomes 0.1 MPa, whichever comes first, to prevent damage to the element.

### Mounting/Adjustment

#### ⚠ Warning

- Set the regulator while verifying the displayed values of the inlet and outlet pressure gauges. Turning the regulator knob excessively can cause damage to the internal parts.
- Do not use tools on the pressure regulator knob as this may cause damage. It must be operated manually.

#### ⚠ Caution

- Be sure to unlock the knob before adjusting the pressure and lock it after setting the pressure. Failure to follow this procedure can cause damage to the knob and the outlet pressure may fluctuate.
  - Pull the pressure regulator knob to unlock. (You can visually verify this with the "orange mark" that appears in the gap.)
  - Push the pressure regulator knob to lock. When the knob is not easily locked, turn it left and right a little and then push it (when the knob is locked, the "orange mark", i.e., the gap will disappear).
- Pulsation will be generated when the difference between the inlet and the outlet pressure is large. In this case, reduce the pressure difference between the inlet and the outlet. Please consult with SMC if the pulsation problem is not resolved.
- When the bowl is installed on the AW30-A/AW40-A, install them so that the lock button lines up to the groove of the front (or the back) of the body to avoid drop or damage of the bowl.

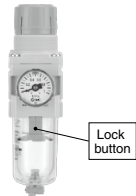

AC-A

AF-A

AF-A

AR-A

AL-A

AW-A

AC-B

AF-A

AF-A

AF-A

AR-A

AL-A

AW-A

AW

AG

E

AV

AF

# AW10-A to AW40-A Series

## Flow Rate Characteristics (Representative values)

Condition: Inlet pressure 0.7 MPa

**AW10-A**

M5

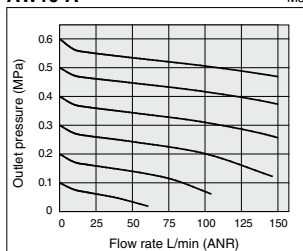

**AW20-A**

Rc1/4

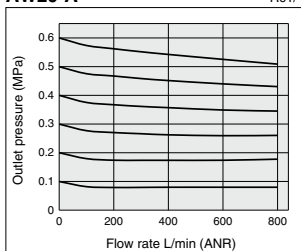

**AW30-A**

Rc3/8

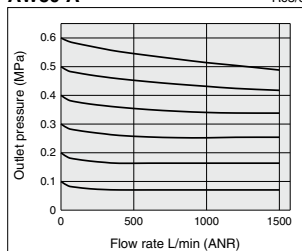

**AW40-A**

Rc1/2

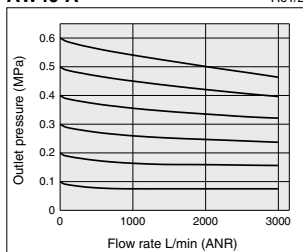

**AW40-06-A**

Rc3/4

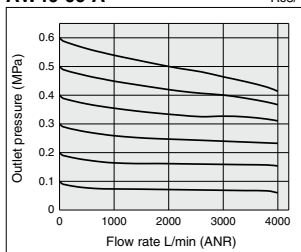

## Pressure Characteristics (Representative values)

Conditions: Inlet pressure 0.7 MPa, Outlet pressure 0.2 MPa, Flow rate 20 L/min (ANR)

**AW10-A**

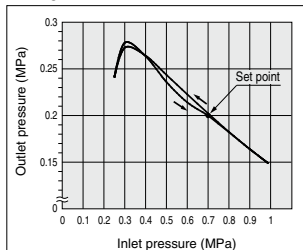

**AW20-A**

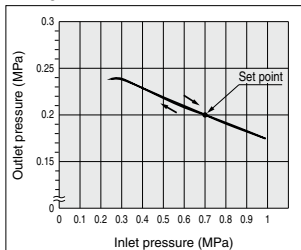

**AW30-A**

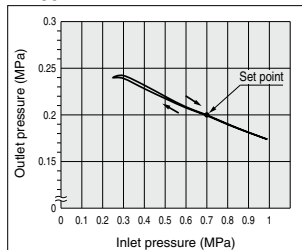

**AW40-A/AW40-06-A**

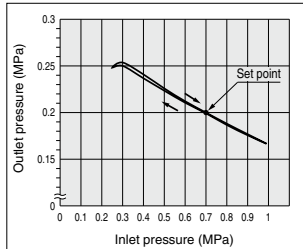



# Filter Regulator **AW10-A to AW40-A Series**

## Construction

**AW10-A**

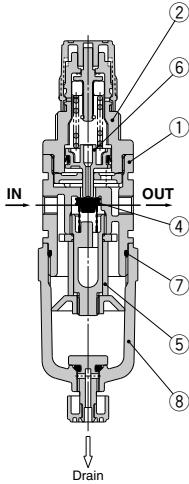

**AW20-A**

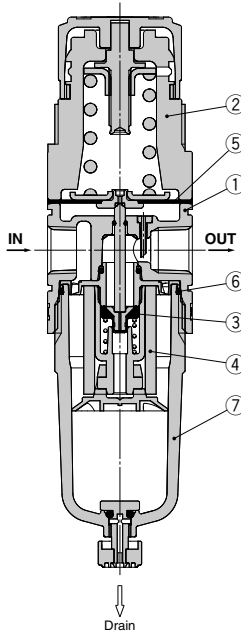

**AW30-A to AW40-06-A**

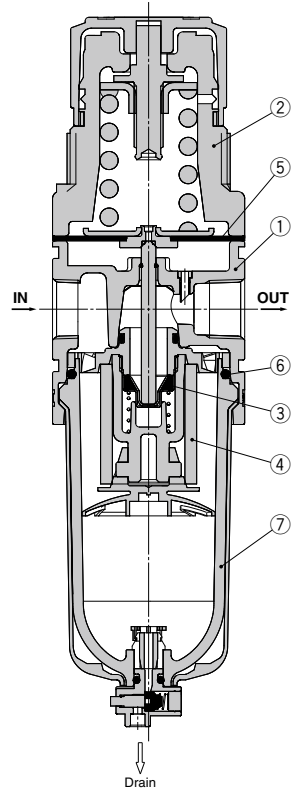

AC-A
AF-A
AF□-A
AR-A
AL-A
<b>AW-A</b>
AC-B
AF-A
AF□-A
AR-B
AL-A
AW-B
AW□
AW□G
E□
AV
AF

### Component Parts

No.	Description	Material	Model	Color
1	Body	Zinc die-cast	AW10-A	White
		Aluminum die-cast	AW20-A to AW40-06-A	
2	Bonnet	Polycetal	AW10-A to AW40-06-A	White

### Replacement Parts

No.	Description	Material	Part no.				
			AW10-A	AW20-A	AW30-A	AW40-A	AW40-06-A
3	Valve assembly	Stainless steel, HNBR	AR10P-090S	AW22P-060AS	AW32P-060AS	AW42P-060AS	
4	Filter element	Non-woven fabric	AF10P-060S	AF20P-060S	AF30P-060S	AF40P-060S	
5	Diaphragm assembly	Weatherable NBR	AR10P-150AS <sup>Note 1)</sup>	AR22P-150AS	AR32P-150AS	AR42P-150AS	
6	Bowl seal	NBR	C1SFP-260S	C2SFP-260S	C32FP-260S	C42FP-260S	
7	Bowl assembly <sup>Note 2)</sup>	Polycarbonate	C1SF-A	C2SF-A	C3SF-A	C4SF-A	

Note 1) The AW10-A is a piston type. Assembly of a piston and a seal (KSYP-13).

Note 2) Bowl seal is included for the AW20-A to AW40-06-A. Please contact SMC regarding the supply of bowl assembly with psi and °F unit display specifications.

# AW10-A to AW40-A Series

## Dimensions

### AW10-A

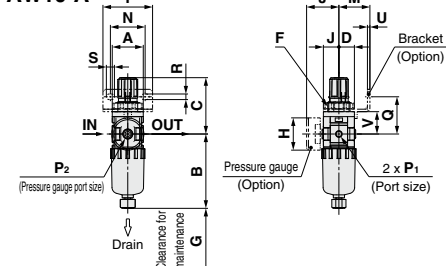

### AW20-A

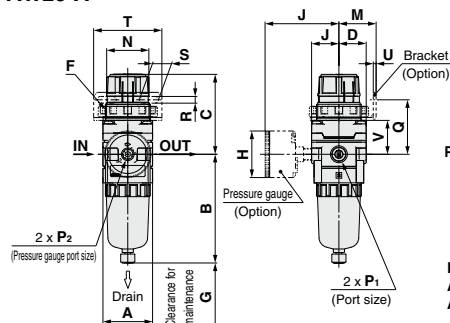

### AW30-A to AW40-06-A

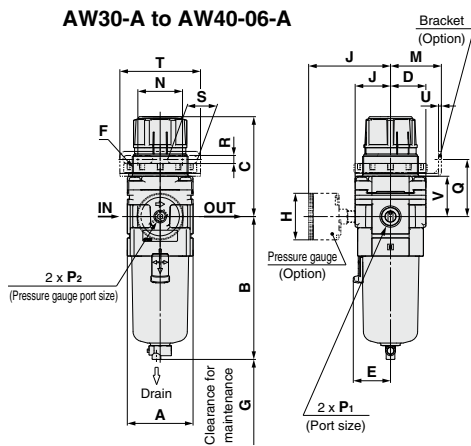

Panel fitting dimensions

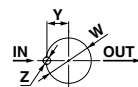

Plate thickness  
AW10-A: Max. 3.5  
AW20-A: Max. 4

Panel fitting dimensions

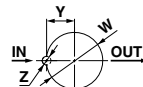

Plate thickness  
AW30-A to AW40-06-A: Max. 8

Applicable model	AW10-A/AW20-A		AW20-A		AW30-A to AW40-06-A
Optional/Semi-standard specifications	With auto drain (N.C.)	Metal bowl	With drain guide	Metal bowl with drain guide	With auto drain (N.O./N.C.)
Dimensions					

Applicable model	AW30-A to AW40-06-A					
Optional/Semi-standard specifications	Metal bowl	Metal bowl with drain guide	Metal bowl with level gauge	Metal bowl with level gauge, with drain guide	With drain guide	Drain cock with barb fitting
Dimensions						

Model	Standard specifications											Optional specifications			
	P <sub>1</sub>	P <sub>2</sub>	A	B	C (Note)	D	E	F	G	J	H	J	H	J	
AW10-A	M5 x 0.8	1/16	25	59.9	47.4	12.5	—	M18 x 1	25	12.5	ø26	26	—	—	
AW20-A	1/8, 1/4	1/8	40	87.6	67.4	22	—	M36 x 1.5	25	22	ø37.5	58.5	ø37.5	59.5	
AW30-A	1/4, 3/8	1/8	53	115.1	83.5	28.5	30	M45 x 1.5	35	28.5	ø37.5	65	ø37.5	66	
AW40-A	1/4, 3/8, 1/2	1/8	70	147.1	100	34.5	38.4	M52 x 1.5	40	34.5	ø42.5	72	ø42.5	72	
AW40-06-A	3/4	1/8	75	149.1	101.5	34.5	38.4	M52 x 1.5	40	34.5	ø42.5	72	ø42.5	72	

Model	Optional specifications										Semi-standard specifications							
	Bracket mount					Panel mount					With auto drain	With barb fitting	With drain guide	Metal bowl	Metal bowl with drain guide	Metal bowl with level gauge	Metal bowl with level gauge, with drain guide	
	M	N	Q	R	S	T	U	V	W	Y	Z	B	B	B	B	B	B	
AW10-A	25	28	30	4.5	6.5	40	2	18	18.5	—	—	77.9	—	—	59.3	—	—	
AW20-A	30	34	43.9	5.4	15.4	55	2.3	27.3	36.5	17.5	6	104.9	—	91.4	87.4	93.9	—	
AW30-A	41	36	46	6.5	24	65	2.3	32.5	45.5	22.5	7	156.8	123.6	121.9	117.6	122.1	137.6	142.1
AW40-A	50	38	54	8.5	26.5	70	2.3	38.4	52.5	26	7	186.9	155.6	153.9	149.6	154.1	169.6	174.1
AW40-06-A	50	38	55.5	8.5	26.5	70	2.3	39.9	52.5	26	7	188.9	157.6	155.9	151.6	156.1	171.6	176.1

Note) The dimension of C is the length when the filter regulator knob is unlocked.

AC-A
AF-A
AF□-A
AR-A
AL-A
<b>AW-A</b>
AC-B
AF-A
AF□-A
<b>AR-A</b>
AL-A
<b>AW-B</b>
AW□
A□G
E□
AV
AF

# Filter Regulator/AW20-A to AW40-06-A

## Made to Order

Please contact SMC for detailed dimensions, specifications and lead times.



### ① 0.4 MPa Setting

The setting specification is 0.4 MPa. When a pressure gauge is included, the display will show a range from 0 to 0.7 MPa.

### Specifications

Proof pressure	1.5 MPa
Maximum operating pressure	1.0 MPa
Set pressure range <small>Note 1)</small>	0.05 to 0.4 MPa

Note 1) Pressure can be set higher than the specification pressure in some cases, but use pressure within the specification range.

### Applicable Model

Model	AW20-A	AW30-A	AW40-A	AW40-06-A
Port size	1/8, 1/4	1/4, 3/8	1/4, 3/8, 1/2	3/4

### ② Long Bowl

Drain capacity is greater than that of standard models.

### Applicable Model/Drain Capacity

Model	AW20-A	AW30-A	AW40-A	AW40-06-A
Port size	1/8, 1/4	1/4, 3/8	1/4, 3/8, 1/2	3/4
Drain capacity (cm <sup>3</sup> )	19	43	88	
B dimension (mm) <small>Note)</small>	108.6	137.1	167.2	169.2

Note) For polycarbonate bowls. Please contact SMC for other bowl materials.



### How to Order

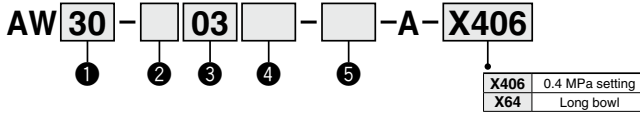

- Option/Semi-standard: Select one each for a to i.
- Option/Semi-standard symbol: When more than one specification is required, indicate in alphanumeric order. Example) AW30-03BG-2N-A-X406

		Symbol	Description
②	Pipe thread type	Nil	Rc
		N <small>Note 2)</small>	NPT
		F <small>Note 3)</small>	G

### 0.4 MPa Setting

### Long Bowl

③	Port size	01	1/8
		02	1/4
		03	3/8
		04	1/2
		06	3/4

①		
Body size		
20	30	40
●	●	●
●	●	●
●	●	●

①		
Body size		
20	30	40
●	●	●
●	●	●
●	●	●

④	a	Mounting	Nil	Without mounting option
			B <small>Note 5)</small>	With bracket
			H	With set nut (for panel mount)
	b	Float type auto drain	Nil	Without auto drain
			C <small>Note 6)</small>	Float type auto drain (N.C.)
			D <small>Note 7)</small>	Float type auto drain (N.O.)
	c	Pressure gauge	Nil	Without pressure gauge
			G	Round type pressure gauge (with limit indicator)
			M	Round type pressure gauge (with color zone)

●	—	—
●	●	●
—	●	●
—	—	●
—	—	●

●	—	—
●	●	●
—	●	●
—	—	●
—	—	●

●	●	●
●	●	●
●	●	●
●	●	●
●	●	●

●	●	●
●	●	●
●	●	●
—	—	—
—	—	—

●	●	●
●	●	●
●	●	●

●	●	●
● <small>Note 8)</small>	● <small>Note 8)</small>	● <small>Note 8)</small>
● <small>Note 8)</small>	● <small>Note 8)</small>	● <small>Note 8)</small>

Note 2) Drain guide is NPT1/8 (applicable to the AW20-A) and NPT1/4 (applicable to the AW30-A to AW40-A). The auto drain port comes with 6/32" One-touch fitting (applicable to the AW30-A to AW40-A).

Note 3) Drain guide is G1/8 (applicable to the AW20-A) and G1/4 (applicable to the AW30-A to AW40-A).

Note 4) Option B, G, H, M are not assembled and supplied loose at the time of shipment.

Note 5) Assembly of a bracket and set nuts.

Note 6) When pressure is not applied, condensate which does not start the auto drain mechanism will be left in the bowl.

Releasing the residual condensate before ending operations for the day is recommended.

Note 7) If the compressor is small (0.75 kW, discharge flow is less than 100 L/min[ANR]), air leakage from the drain cock may occur during start of operations. N.C. type is recommended.

Note 8) When the pressure gauge is attached, a 1.0 MPa pressure gauge will be fitted for standard (0.7 MPa) type. 0.4 MPa pressure gauge for 0.2 MPa type.

- AC-A
- AF-A
- AF□-A
- AR-A
- AL-A
- AW-A**
- AC-B
- AF-A
- AF□-A
- AR-B
- AL-A
- AW-B
- AW□
- AF-G
- E□
- AV
- AF

		Symbol	Description	0.4 MPa Setting			Long Bowl			
				①			①			
				Body size			Body size			
				20	30	40	20	30	40	
5 Semi-standard	d	Set pressure <small>Note 9)</small>	<b>Nil</b>	0.05 to 0.7 MPa setting	—	—	—	●	●	●
			<b>1</b>	0.02 to 0.2 MPa setting	—	—	—	●	●	●
			+							
	e	Bowl <small>Note 10)</small>	<b>Nil</b>	Polycarbonate bowl	●	●	●	●	●	●
			<b>2</b>	Metal bowl	●	●	●	●	●	●
			<b>6</b>	Nylon bowl	●	●	●	●	●	●
			<b>8</b>	Metal bowl with level gauge	—	●	●	—	—	—
			<b>C</b>	With bowl guard	●	—	—	●	—	—
			<b>6C</b>	With bowl guard (Nylon bowl)	●	—	—	●	—	—
			+							
	f	Drain port <small>Note 11)</small>	<b>Nil</b>	With drain cock	●	●	●	●	●	●
			<b>J</b> <small>Note 14)</small>	Drain guide 1/8	●	—	—	●	—	—
			<b>W</b> <small>Note 15)</small>	Drain guide 1/4	—	●	●	—	●	●
				Drain cock with barb fitting (for ø6 x ø4 nylon tube)	—	●	●	—	●	●
			+							
g	Exhaust mechanism	<b>Nil</b>	Relieving type	●	●	●	●	●	●	
		<b>N</b>	Non-relieving type	●	●	●	●	●	●	
		+								
h	Flow direction	<b>Nil</b>	Flow direction: Left to right	●	●	●	●	●	●	
		<b>R</b>	Flow direction: Right to left	●	●	●	●	●	●	
		+								
i	Pressure unit	<b>Nil</b>	Name plate and caution plate for bowl in imperial units: MPa	●	●	●	●	●	●	
		<b>Z</b> <small>Note 16)</small>	Name plate and caution plate for bowl in imperial units: psi, °F	○ <small>Note 17)</small>	○ <small>Note 17)</small>	○ <small>Note 17)</small>	○ <small>Note 17)</small>	○ <small>Note 17)</small>	○ <small>Note 17)</small>	

Note 9) Pressure can be set higher than the specification pressure in some cases, but use pressure within the specification range.  
 Note 10) Refer to Chemical data on page 471 for chemical resistance of the bowl.  
 Note 11) The combination of float type auto drain: C and D is not available.  
 Note 12) A bowl guard is provided as standard equipment (polycarbonate).  
 Note 13) A bowl guard is provided as standard equipment (nylon).  
 Note 14) Without a valve function  
 Note 15) The combination of metal bowl: 2 and 8 is not available.  
 Note 16) For pipe thread type: NPT. This product is for overseas use only according to the new Measurement Law. (The SI unit type is provided for use in Japan.)  
 Cannot be used with M: Round pressure gauge (with color zone). Available by request for special.  
 Note 17) ○: For pipe thread type: NPT only

# Filter Regulator/AW20-A to AW40-06-A

## Made to Order

Please contact SMC for detailed dimensions, specifications and lead times.



### ③ 0.85 MPa Setting

The maximum set pressure is 0.85 MPa. When a pressure gauge is included, the display will show a range from 0 to 1.0 MPa.

### Specifications

Proof pressure	1.5 MPa
Maximum operating pressure	1.0 MPa
Set pressure range	0.05 to 0.85 MPa

### Applicable Model

Model	AW20-A	AW30-A	AW40-A	AW40-06-A
Port size	1/8, 1/4	1/4, 3/8	1/4, 3/8, 1/2	3/4

### How to Order

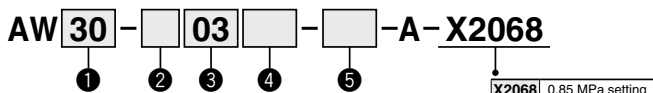

- Option/Semi-standard: Select one each for a to h.
- Option/Semi-standard symbol: When more than one specification is required, indicate in alphanumeric order.  
Example) AW30-03BG-2N-A-X2068

### 0.85 MPa Setting

		Symbol	Description	①			
				Body size			
				20	30	40	
②	Pipe thread type	Nil	Rc	●	●	●	
		N <sup>Note 1)</sup>	NPT	●	●	●	
		F <sup>Note 2)</sup>	G	●	●	●	
+							
③	Port size	01	1/8	●	—	—	
		02	1/4	●	●	●	
		03	3/8	—	●	●	
		04	1/2	—	—	●	
		06	3/4	—	—	●	
+							
④ Option (Note 3)	a	Mounting	Nil	Without mounting option	●	●	●
			B <sup>Note 4)</sup>	With bracket	●	●	●
			H	With set nut (for panel mount)	●	●	●
	+						
	b	Float type auto drain	Nil	Without auto drain	●	●	●
			C <sup>Note 5)</sup>	Float type auto drain (N.C.)	●	●	●
			D <sup>Note 6)</sup>	Float type auto drain (N.O.)	—	●	●
	+						
	c	Pressure gauge	Nil	Without pressure gauge	●	●	●
			G	Round type pressure gauge (with limit indicator)	●	●	●
			M	Round type pressure gauge (with color zone)	●	●	●

Note 1) Drain guide is NPT1/8 (applicable to the AW20-A) and NPT1/4 (applicable to the AW30-A to AW40-A).

The auto drain port comes with ø3/8" One-touch fitting (applicable to the AW30-A to AW40-A).

Note 2) Drain guide is G1/8 (applicable to the AW20-A) and G1/4 (applicable to the AW30-A to AW40-A).

Note 3) Option B, G, H, M are not assembled and supplied loose at the time of shipment.

Note 4) Assembly of a bracket and set nuts

Note 5) When pressure is not applied, condensate which does not start the auto drain mechanism will be left in the bowl.

Releasing the residual condensate before ending operations for the day is recommended.

Note 6) If the compressor is small (0.75 kW, discharge flow is less than 100 L/min[ANR]), air leakage from the drain cock may occur during start of operations.

N.C. type is recommended.

- AC-A
- AF-A
- AF□-A
- AR-A
- AL-A
- AW-A**
- AC-B
- AF-A
- AF□-A
- AR- $\frac{B}{8}$
- AL-A
- AW- $\frac{B}{8}$
- AW□
- A□G
- E□
- AV
- AF

**0.85 MPa Setting**

		Symbol	Description	①			
				Body size			
				20	30	40	
5	d	Bowl <small>Note 7)</small>	Nil	Polycarbonate bowl	●	●	●
			2	Metal bowl	●	●	●
			6	Nylon bowl	●	●	●
			8	Metal bowl with level gauge	—	●	●
			C	With bowl guard	●	—	—
			6C	With bowl guard (Nylon bowl)	●	—	—
	+						
	e	Drain port <small>Note 8)</small>	Nil	With drain cock	●	●	●
			J <small>Note 9)</small>	Drain guide 1/8	●	—	—
			W <small>Note 10)</small>	Drain cock with barb fitting (for $\phi 6 \times \phi 4$ nylon tube)	—	●	●
+							
f	Exhaust mechanism	Nil	Relieving type	●	●	●	
		N	Non-relieving type	●	●	●	
+							
g	Flow direction	Nil	Flow direction: Left to right	●	●	●	
		R	Flow direction: Right to left	●	●	●	
+							
h	Pressure unit	Nil	Name plate and caution plate for bowl in imperial units: MPa	●	●	●	
		Z <small>Note 11)</small>	Name plate and caution plate for bowl in imperial units: ps <sub>i</sub> , °F	○ <small>Note 12)</small>	○ <small>Note 12)</small>	○ <small>Note 12)</small>	

Note 7) Refer to Chemical data on page 471 for chemical resistance of the bowl.  
 Note 8) The combination of float type auto drain: C and D is not available.  
 Note 9) Without a valve function  
 Note 10) The combination of metal bowl: 2 and 8 is not available.  
 Note 11) For pipe thread type: NPT. This product is for overseas use only according to the new Measurement Law. (The SI unit type is provided for use in Japan.)  
 Cannot be used with M: Round pressure gauge (with color zone). Available by request for special.  
 Note 12) ○: For pipe thread type: NPT only