

Direct Operated Precision Regulator

ARP20/30/40 Series

RoHS

- **Sensitivity: Within 0.2% F.S.**
- **Energy saving, Air consumption: 80% reduction** (SMC comparison)
Reduced to 0.8 L/min from 4 to 6 L/min in the current product (ARP3000).
- **Repeatability: Within $\pm 1\%$ F.S.** (or within ± 3 kPa*)
* For 0.2 MPa setting
- **With backflow function** (ARP20K/30K/40K)
Installable between a solenoid valve and a cylinder

- **Expanded lineup** ●
3 types of set pressure and the body size allow more freedom in designing a circuit.

Model	ARP20(K)	ARP30(K)	ARP40(K)
Setting			
0.2 MPa	▲	▲	▲
0.4 MPa	●	●	●
0.6 MPa	▲	▲	▲
Port size			
1/8	●	—	—
1/4	●	●	●
3/8	—	●	●
1/2	—	—	●

●: Standard ▲: Semi-standard

Direct operated precision regulator now available as a series!! (ARP20/30/40)

Applications

- Ⓐ Apply a constant pressure to fluid.

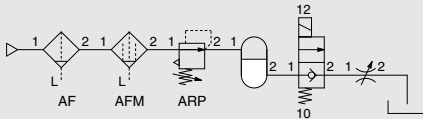

- Ⓑ Adjust the blow-line pressure.

Sensitivity within 0.2% F.S. allows more precise pressure adjustment.

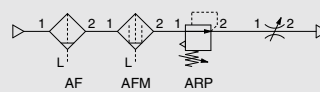

- Ⓒ Control a clamping force by precise pressure control.

Sensitivity within 0.2% F.S. allows more precise pressure adjustment. Repeatability within $\pm 1\%$ F.S. (or within ± 3 kPa) allows constant clamping force.

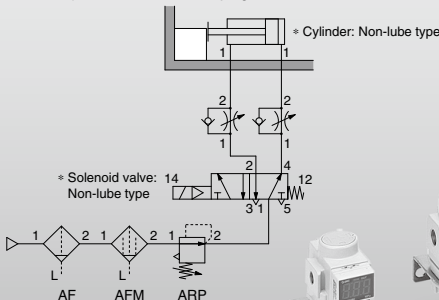

- Ⓓ Release residual pressure with the backflow function.

- **Residual pressure circuit**
Also exhausts residual pressure completely.

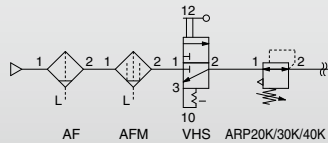

When the air supply is cut off and releasing the inlet pressure to the atmosphere, the residual pressure release of the outlet side can be ensured for a safety purpose.

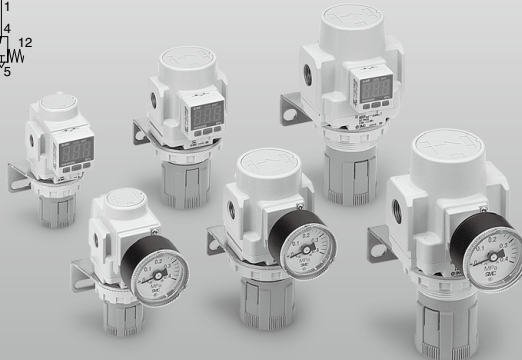

ARP20 to ARP40 Series



Direct Operated Precision Regulator with Backflow Function/Modular Type

ARP20K to ARP40K Series

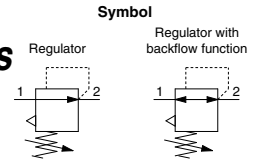

- With the backflow function it incorporates a mechanism to exhaust the air pressure in the outlet side reliably and quickly.

Example 1)
When the pressure in the rear and the front of the cylinder differs:

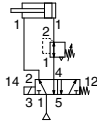

Example 2)
When the air supply is cut off and releasing the inlet pressure to the atmosphere, the residual pressure release of the outlet side can be ensured for a safety purpose.

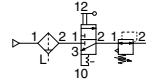

How to Order

ARP **30** **K** - **03** **BE** -

1 2 3 4 5 6

- Option / Semi-standard: Select one each for **a** to **f**.
- Option / Semi-standard symbol: Enter them alphanumerically.
Example) ARP30K-03BE-1RY

	Symbol	Description	① Body size				
			20	30	40		
② With backflow function	Nil	Without backflow function	●	●	●		
	K	With backflow function	●	●	●		
+							
③ Thread type	Nil	Rc	●	●	●		
	N	NPT	●	●	●		
	F	G	●	●	●		
+							
④ Port size	01	1/8	●	—	—		
	02	1/4	●	●	●		
	03	3/8	—	●	●		
	04	1/2	—	—	●		
+							
⑤ Option	a Mounting	Nil	Without mounting option	●	●	●	
		B <small>Note 2)</small>	With bracket	●	●	●	
		H	With set nut (For panel mount)	●	●	●	
	+						
	b	Pressure gauge	Nil	Without pressure gauge	●	●	●
			E	Square embedded type pressure gauge (With limit indicator)	●	●	●
			G	Round type pressure gauge (With limit indicator)	●	●	●
		Digital pressure switch	E1 <small>Note 3)</small>	Output: NPN output / Electrical entry: Wiring bottom entry	●	●	●
			E2 <small>Note 3)</small>	Output: NPN output / Electrical entry: Wiring top entry	●	●	●
			E3 <small>Note 3)</small>	Output: PNP output / Electrical entry: Wiring bottom entry	●	●	●
E4 <small>Note 3)</small>			Output: PNP output / Electrical entry: Wiring top entry	●	●	●	

Direct Operated Precision Regulator/Modular Type **ARP20 to ARP40 Series**

Direct Operated Precision Regulator with Backflow Function/Modular Type **ARP20K to ARP40K Series**



ARP20/ARP20K

ARP30/ARP30K

ARP40/ARP40K

		Symbol	Description	①			
				Body size			
				20	30	40	
⑥ Semi-standard	c	Set pressure	Nil	0.005 to 0.4 MPa setting	●	●	●
			1 ^{Note 4)}	0.005 to 0.2 MPa setting	●	●	●
			3 ^{Note 4)}	0.008 to 0.6 MPa setting	●	●	●
			+				
	d	Flow direction	Nil	Flow direction: Left to right	●	●	●
			R	Flow direction: Right to left	●	●	●
			+				
	e	Knob	Nil	Downward facing knob	●	●	●
			Y	Upward facing knob	●	●	●
			+				
f	Pressure unit	Nil	Name plate and pressure gauge in imperial units: MPa	●	●	●	
		Z ^{Note 5)}	Name plate and pressure gauge in imperial units: psi	○ ^{Note 7)}	○ ^{Note 7)}	○ ^{Note 7)}	
		ZA ^{Note 6)}	Digital pressure switch: With unit conversion function	△ ^{Note 8)}	△ ^{Note 8)}	△ ^{Note 8)}	

Note 1) Options B, G, H are shipped together, (but not assembled).

Note 2) Set nut is included for bracket.

Note 3) When choosing with H (panel mount), the installation space for lead wires will not be secured. In this case, select "wiring top entry" for the lead wire entry. (Select "wiring bottom entry" when the semi-standard Y is chosen simultaneously.)

Note 4) The only difference from the standard specifications is the pressure regulator spring.

It does not restrict the setting of 0.2 MPa/0.6 MPa or more.

When the pressure gauge is attached, a 0.2 MPa pressure gauge for 0.2 MPa setting will be fitted, and a 0.7 MPa pressure gauge for 0.6 MPa setting will be fitted.

When a digital pressure switch is attached, the pressure display is fixed to 1.0 MPa.

Note 5) For thread type: NPT. This product is for overseas use only according to the new Measurement Law. (The SI unit type is provided for use in Japan.) The digital pressure switch will be equipped with the unit conversion function, setting to psi initially.

Note 6) For options: E1, E2, E3, E4. This product is for overseas use only according to the new Measurement Law. (The SI unit is provided for use in Japan.)

Note 7) ○: For thread type: NPT only

Note 8) △: Combination available for options: E1, E2, E3, E4.

ARJ

AR425
to 935

ARX

AMR

ARM

ARP

IR□-A

IR

IRV

VEV

SRH

SRP

SRF

ITV

IC

ITVH

ITVX

PVQ

VY1

VBA

VBAT

AP100

ARP20/30/40 Series

Specifications

Model			ARP20(K)	ARP30(K)	ARP40(K)
Port size			1/8, 1/4	1/4, 3/8	1/4, 3/8, 1/2
Fluid			Air		
Proof pressure			1.2 MPa		
Max. operating pressure			0.7 MPa		
Set pressure range <small>Note 1)</small>	For 0.4 MPa setting	Ex.) ARP30-02BG	0.005 to 0.4 MPa		
	For 0.2 MPa setting	Ex.) ARP30-02BG-1	0.005 to 0.2 MPa		
	For 0.6 MPa setting	Ex.) ARP30-02BG-3	0.008 to 0.6 MPa		
Sensitivity			Within 0.2% F.S.		
Repeatability <small>Note 2)</small>			Within $\pm 1\%$ F.S. (or ± 3 kPa)		
Air consumption	For 0.4 MPa setting	Ex.) ARP30-02BG	1 L/min (ANR) or less (at P2 = 0.4 MPa)		
	For 0.2 MPa setting	Ex.) ARP30-02BG-1	0.6 L/min (ANR) or less (at P2 = 0.2 MPa)		
	For 0.6 MPa setting	Ex.) ARP30-02BG-3	1.4 L/min (ANR) or less (at P2 = 0.6 MPa)		
Pressure port size <small>Note 3)</small>			1/8	1/8	1/4
Ambient and fluid temperature			-5 to 60°C (No freezing)		
	With digital pressure switch	Ex.) ARP30-02BE1	-5 to 50°C (No freezing)		
Construction			Bleed type		
Weight (kg) <small>Note 4)</small>			0.2	0.3	0.5

Note 1) When a product with backflow function (ARP20K to 40K) is chosen, set the inlet pressure 0.05 MPa or higher than the set pressure.

Note 2) For the type set to 0.2 MPa only, repeatability will be within ± 3 kPa.

Note 3) Port thread is not provided for products with square embedded-type pressure gauges.

Note 4) Weight shown is for product without any options.

Optional Parts

Model			ARP20(K)	ARP30(K)	ARP40(K)	
Bracket assembly <small>Note 1)</small>			ARP20P-270AS	ARP30P-270AS	ARP40P-270AS	
Set nut			AR23P-260S	AR33P-260S	AR43P-260S	
Pressure gauge	0.4 MPa	Round type <small>Note 2)</small>	G36-4-□01		G46-4-□02	
		Square embedded type <small>Note 3)</small>	GC3-4AS [GC3P-010AS (Pressure gauge cover only)]			
	0.2 MPa	Round type <small>Note 2)</small>	G36-2-□01		G46-2-□02	
		Square embedded type <small>Note 3)</small>	GC3-2AS [GC3P-010AS (Pressure gauge cover only)]			
	0.7 MPa	Round type <small>Note 2)</small>	G36-7-□01		G46-7-□02	
		Square embedded type <small>Note 3)</small>	GC3-7AS [GC3P-010AS (Pressure gauge cover only)]			
	Digital type <small>Note 4)</small>	NPN output / Wiring bottom entry		ISE35-N-25-MLA [ISE35-N-25-M (Switch body only)]		
		NPN output / Wiring top entry		ISE35-R-25-MLA [ISE35-R-25-M (Switch body only)]		
		PNP output / Wiring bottom entry		ISE35-N-65-MLA [ISE35-N-65-M (Switch body only)]		
PNP output / Wiring top entry		ISE35-R-65-MLA [ISE35-R-65-M (Switch body only)]				

Note 1) Assembly includes a bracket and set nuts.

Note 2) □ in part numbers for a round-type pressure gauge indicates a type of connection thread. No indication is necessary for R; however, indicate N for NPT. The G thread is unavailable. If it is required, select the R thread type (Nil) instead. Please contact SMC regarding the connection thread NPT and pressure gauge supply for psi unit specifications.

Note 3) Includes one O-ring and 2 mounting screws. []: Pressure gauge cover only.

Note 4) Lead wire with connector (2 m), adapter, lock pin, O-ring (1 pc.), and mounting screws (2 pcs.) are included. []: Switch body only.
For how to order the digital pressure switch, refer to page 767.

Direct Operated Precision Regulator/Modular Type **ARP20/30/40 Series**

Condition:
Inlet pressure 0.7 MPa

Conditions:
Inlet pressure 0.5 MPa
Outlet pressure 0.2 MPa
Flow rate 20 L/min (ANR)

Flow Rate Characteristics (Representative values)

Pressure Characteristics (Representative values)

ARP20(K)

Rc 1/4

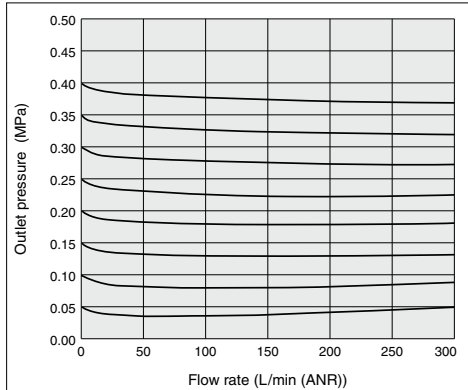

ARP20(K)

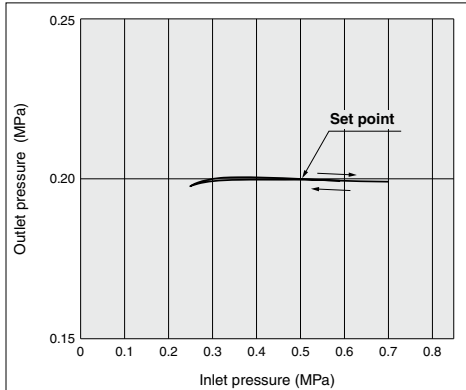

ARP30(K)

Rc 3/8

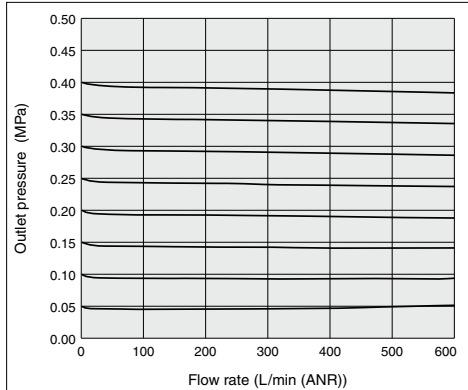

ARP30(K)

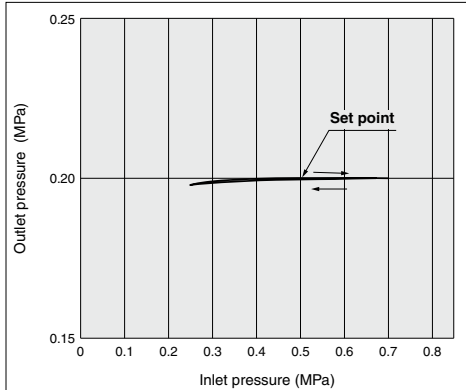

ARP40(K)

Rc 1/2

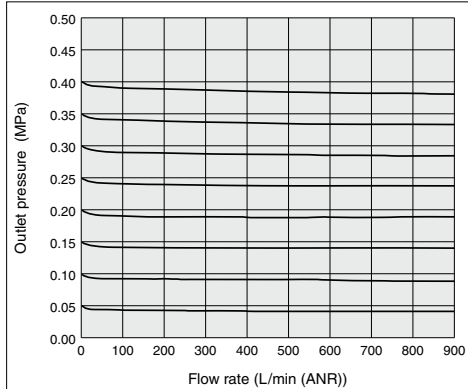

ARP40(K)

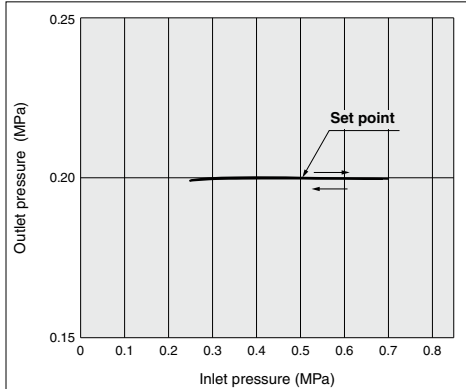

ARJ

AR425
to 935

ARX

AMR

ARM

ARP

IR□-A

IR

IRV

VEX

SRH

SRP

SRF

ITV

IC

ITVH

ITVX

PVQ

VY1

VBA

VBAT

AP100

ARP20/30/40 Series

Construction

ARP20(K)/30(K)/40(K)

ARP20K/30K/40K (With backflow function)

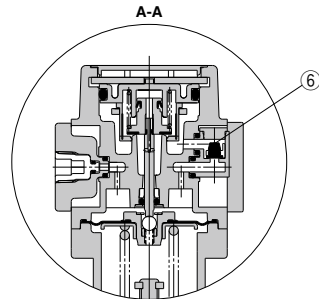
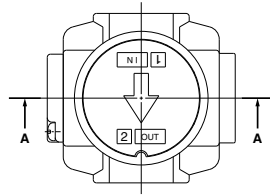
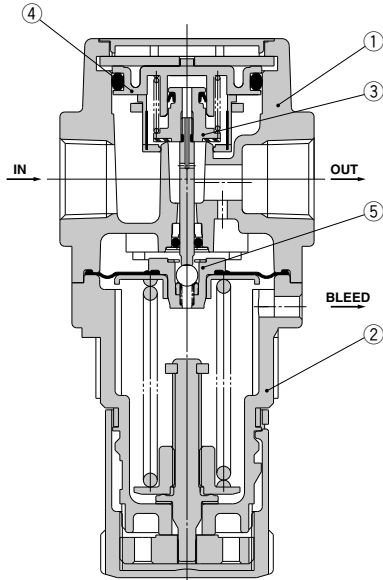

Component Parts

No.	Description	Material	Note
1	Body	Aluminum die-casted	External color: White
2	Bonnet	Polycetal	External color: White

Replacement Parts

No.	Description	Material	Part no.		
			ARP20(K)	ARP30(K)	ARP40(K)
3	Valve assembly	Brass, HNBR, NBR	ARP20P-330AS	ARP30P-330AS	ARP40P-330AS
4	Valve guide assembly	Polycetal, NBR	ARP20P-050AS	ARP30P-050AS	ARP40P-050AS
5	Diaphragm assembly	HNBR, Stainless steel, Brass	ARP20P-151AS	ARP30P-151AS	ARP40P-151AS
6 ^{Note)}	Check valve assembly	—	AR20KP-020AS		

Note) Check valve assembly is the replacement part for a regulator with backflow function (ARP20K to 40K).
 Assembly of check valve body assembly, check valve cover and 2 screws

Working Principle (Regulator with Backflow Function)

ARP20K/30K/40K

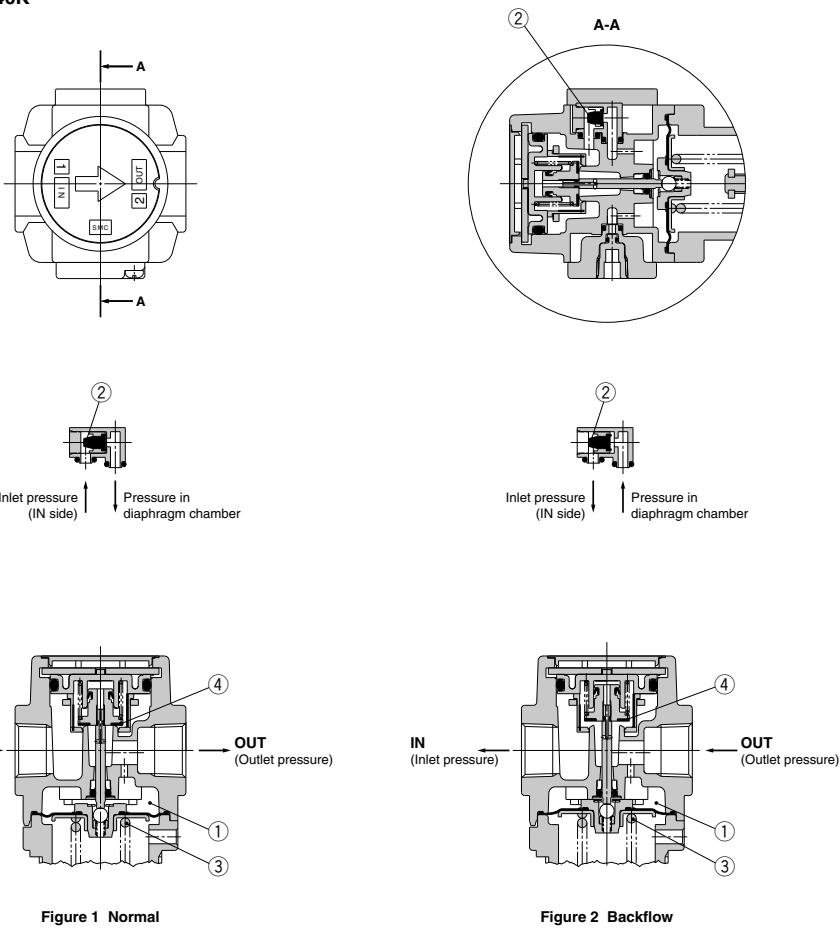

Figure 1 Normal

Figure 2 Backflow

When the inlet pressure is higher than the set pressure, the check valve ② closes and operates as a normal regulator (Figure 1). When the inlet pressure is shut off and released, the check valve ② opens and the pressure in the diaphragm chamber ① is released to the inlet side (Figure 2). This lowers the pressure in the diaphragm chamber ① and the force generated by the pressure regulator spring ③ pushes down the diaphragm. Valve ④ opens through the stem, and the outlet pressure is released to the inlet side (Figure 2).

ARJ
AR425 to 935
ARX
AMR
ARM
ARP
IR□-A
IR
IRV
VEX
SRH
SRP
SRF
ITV
IC
ITVH
ITVX
PVQ
VY1
VBA
VBAT
AP100

ARP20/30/40 Series

Dimensions

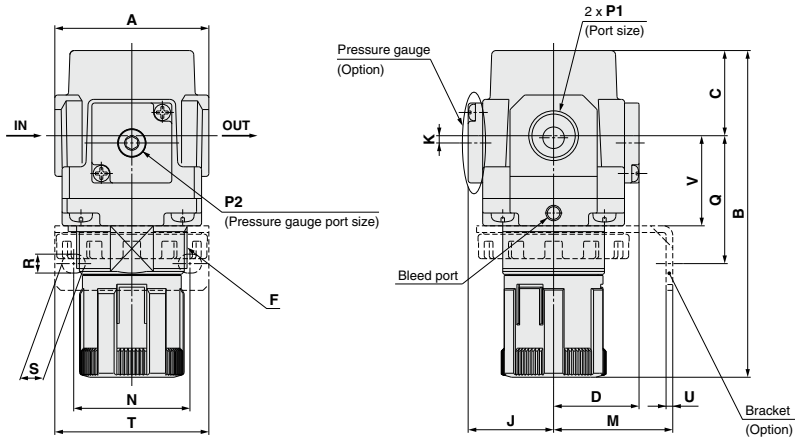

Panel fitting dimension

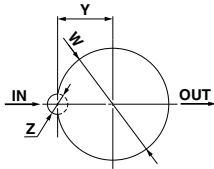
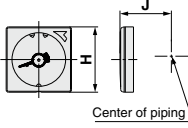
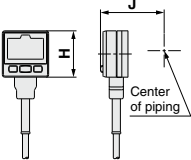
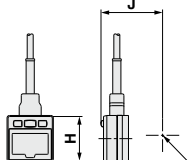
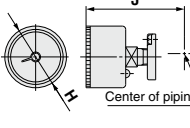

Plate thickness
 ARP20(K), ARP30(K): Max. 3.5
 ARP40(K): Max. 5

Pressure Gauge Option

Option	Square embedded type pressure gauge	Digital pressure switch (Electrical entry: Wiring bottom entry)	Digital pressure switch (Electrical entry: Wiring top entry)	Round type pressure gauge
Dimensions				

Model	Standard specifications									
	P1	P2	A	B (Note 1)	C	D	F	J	K	
ARP20(K)	1/8, 1/4	1/8	40	98	27	28.5	M28 x 1	28.5	2 (Note 2)	
ARP30(K)	1/4, 3/8	1/8	53	117	29	29.5	M38 x 1.5	29.5	2.5	
ARP40(K)	1/4, 3/8, 1/2	1/4	70	148	41	34	M42 x 1.5	34	1	

Model	Optional specifications																
	Square embedded type pressure gauge		Digital pressure switch		Round type pressure gauge		Bracket mount dimension						Panel mount				
	H	J	H	J	H	J	M	N	Q	R	S	T	U	V	W	Y	Z
ARP20(K)	□28	29.5	□27.8	40	∅37.5	66	30	34	47	5.4	15.4	5.5	2.3	28	28.5	14	6
ARP30(K)	□28	30.5	□27.8	41	∅37.5	67	41	40	44	6.5	8	5.3	2.3	31	38.5	19	7
ARP40(K)	□28	35	□27.8	45	∅42.5	74	50	54	54	8.5	10.5	7.0	2.3	35.5	42.5	21	7

Note 1) The total length of B dimension is the length when the filter regulator knob is unlocked.

Note 2) For ARP20(K) only, the position of the pressure gauge is above the center of the piping.

Options

Digital Pressure Switch



Refer to Best Pneumatics No. 8 for Pressure Switch Precautions, and the Operation Manual on SMC's website for Specific Product Precautions.

ISE35-**N**-**25**-**M****L****A**

① ② ③ ④ ⑤

	Symbol	Description
① Electrical entry	N	Wiring bottom entry
	R	Wiring top entry
② Output	25	NPN output
	65	PNP output
③ Unit	Nil	With unit conversion function
	M	Fixed SI unit
	P	Pressure unit: psi (Initial value), with unit conversion function
④ Lead wire	Nil	Without lead wire
	L	Lead wire with connector (2 m)
⑤ Accessories	Nil	Without accessories (Switch body only)
	A	With accessories (Adapter, O-ring: 1 pc., Mounting screw: 2 pcs., Lock pin)

Note 1) Under the New Measurement Law, sales of switches with the unit switching function have not been allowed for use in Japan.
 Note 2) Unit name plate is attached.
 Note 3) Operation manual is included.
 Note 4) When ordering the body only, select the symbol from ① to ⑤ respectively.

Specifications

Rated pressure range	0 to 1 MPa
Display/Set pressure range	-0.1 to 1 MPa
Withstand pressure	1.5 MPa
Display/Minimum setting unit	0.01 MPa
Applicable fluid	(Air, Non-corrosive gas, Non-flammable gas)
Power supply voltage	12 to 24 VDC \pm 10%, Ripple (p-p) 10% or less (With power supply polarity protection)
Current consumption	55 mA or less (at no load)
Switch output	NPN or PNP open collector output: 1 output
Max. load current	80 mA
Max. applied voltage	30 V (With NPN output)
Residual voltage	1 V or less (With load current of 80 mA)
Response time	1 s (0.25, 0.5, 2, 3)
Short circuit protection	Yes
Repeatability	\pm 1% F.S.
Hysteresis	Variable (0 or above)
Hysteresis mode	
Window comparator mode	
Display	3-digit, 7-segment indicator, 2-color display (Red/Green) can be interlocked with the switch output.
Display accuracy	\pm 2% F.S. \pm 1 digit (25°C \pm 3°C)
Indicator light	Light up when output is turned ON. (Green)
Environmental resistance	Enclosure IP40
Operating temperature range	- 5 to 50°C (No freezing or condensation)
Lead wire with connector (Note) (Option: L)	ϕ 3.4 3-wire 25 AWG 2 m With connector cover
Weight	Approx. 14 g (body only)/Approx. 38 g (including lead wire with connector)
Standards	CE, UL, CSA, RoHS

Note) Refer to the Operation Manual in SMC's website (<http://www.smccworld.com>) for wiring.

Digital Pressure Switch Construction

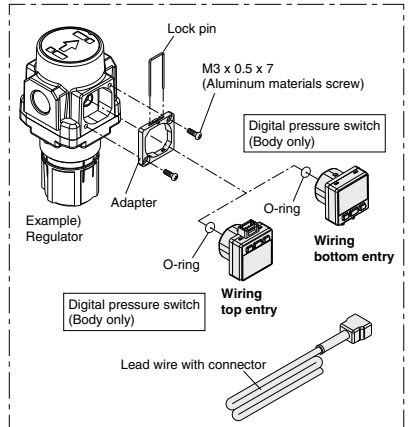

●Dimensions/Lead wire with connector ZS-32-A

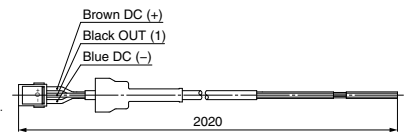

ARJ

AR425 to 935

ARX

AMR

ARM

ARP

IR□-A

IR

IRV

VE X

SRH

SRP

SRF

ITV

IC

ITVH

ITVX

PVQ

VY1

VBA

VBAT

AP100



ARP20/30/40 Series Specific Product Precautions 1

Be sure to read this before handling the products.

Refer to back page 50 for Safety Instructions and pages 387 to 391 for Precautions on every series.

Design

⚠ Warning

1. Be sure to install a safety device to prevent damage or malfunction of the outlet side components when the output pressure exceeds the set pressure value.
2. Please consult with SMC if the intended application calls for absolutely zero leakage due to special atmospheric requirements, or if the use of a fluid other than air is required.

⚠ Caution

1. Select a model that is suitable for the desired cleanliness by referring to the SMC's Best Pneumatics catalog.
2. Components cannot be used for applications that are outside the range of specifications.
Please consult with SMC when you anticipate using the component outside the range of its specifications (such as temperature and pressure).
3. Even when the product is used in the specified range, it may chatter depending on the operating conditions. Please contact SMC for the details of this chattering.

Selection

⚠ Warning

1. The mineral grease used on internal sliding parts and seals may run down to outlet side components.
Please consult with SMC if this is not desirable.
2. Residual pressure release (outlet pressure release) is not complete by releasing the inlet pressure.
To release residual pressure, select a model with a backflow function. Using a model without a backflow function makes for inconsistent residual pressure release (i.e., residual pressure may or may not be released) depending upon the operating conditions.
3. Please contact SMC if air will not be consumed in the system for a long period of time, or if the outlet side will be used with a sealed circuit and a balanced circuit, as this may cause the set pressure of the outlet side to fluctuate.
4. Set the regulating pressure range for the outlet pressure of the regulator in a range that is 90% or less of the inlet pressure.
If set to above 90%, the outlet pressure will be easily affected by fluctuations in the flow rate and inlet pressure, and become unstable.
5. A safety margin is calculated into the maximum regulating pressure range appearing in the catalog's specification table.
The outlet pressure may exceed the set pressure.
6. Please contact SMC when a circuit requires the use of a regulator having relief sensitivity with high precision and setting accuracy.

Mounting

⚠ Caution

1. To avoid reversed connections of the air inlet/outlet, make connections after confirming the "IN/OUT" mark or arrows that indicate the direction of air flow. Reversed connections can cause malfunction.
2. Leave a space of 100 mm or more for maintenance on the valve guide side (opposite side from the knob).
3. When the product is installed between a solenoid valve and an actuator, select a backflow function type.

Adjustment

⚠ Warning

1. Set the regulator while verifying the displayed values of the inlet and outlet pressure gauges.
Turning the knob excessively can cause damage to the internal parts.
2. Do not use a tool on the pressure regulator knob as this can cause damage. It must be operated manually.

⚠ Caution

1. Be sure to check the inlet pressure before setting the outlet pressure.
2. Be sure to unlock the knob before adjusting the pressure and lock it after setting the pressure.

Failure to follow this procedure can cause damage to the knob and the outlet pressure may fluctuate.

- Pull the pressure regulator knob to unlock. (You can visually verify this with the "orange mark" that appears in the gap.)
- Push the pressure regulator knob to lock. When the knob is not easily locked, turn it left and right a little and then push it (when the knob is locked, the "orange mark", i.e., the gap will disappear).

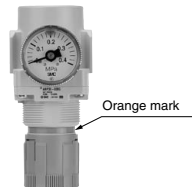

3. To set the pressure using the knob, turn the knob in the direction that increases pressure and lock the knob after the pressure is set.

If this is done in the direction that decreases pressure, the pressure may drop from the original set pressure. Turning the knob clockwise increases the outlet pressure, and turning it counterclockwise reduces the pressure.

4. Do not apply pressure exceeding the range of specifications.

It can damage the pressure gauge.



ARP20/30/40 Series

Specific Product Precautions 2

Be sure to read this before handling the products.

Refer to back page 50 for Safety Instructions and pages 387 to 391 for Precautions on every series.

Adjustment

Caution

5. The product consumes a small amount of fluid from the bleed port.

The product is designed to have a bleed mechanism for highly accurate pressure adjustment, and consumes a small amount of fluid from the bleed port. This should not be considered abnormal.

Air Supply

Warning

1. Use a mist separator on the inlet side of the product.
If the supplied air contains condensate or dust, the bleed mechanism can malfunction.
2. Do not use a lubricator on the inlet side of the product, as the bleed mechanism can malfunction.

Piping

Warning

1. To screw piping materials into components, tighten with a recommended tightening torque while holding the female thread side.

If the minimum tightening torque is not observed, this can cause a looseness and seal failure. On the other hand, excess tightening torque can cause damage to the threads. Furthermore, tightening without holding the female thread side can cause damage due to the excess force that is applied directly to the piping bracket.

Recommended Tightening Torque

Unit: N·m

Connection thread	1/8	1/4	3/8	1/2
Torque	7 to 9	12 to 14	22 to 24	28 to 30

2. Avoid excessive torsional moment or bending moment other than those caused by the equipment's own weight as this can cause damage.
Support external piping separately.
3. Piping materials without flexibility such as steel tube piping are prone to be affected by excess moment load and vibration from the piping side. Use flexible tubing in between to avoid such an effect.

Maintenance

Warning

1. When disassembly or installation is required during the maintenance, repair, or replacement of a device, be sure to follow the instructions provided in the operation manual or safety instructions in this catalog.
2. When using the regulator with backflow function between a solenoid valve and an actuator, check the pressure gauge periodically.

Sudden pressure fluctuations may shorten the durability of the pressure gauge. A digital pressure gauge is recommended for such situation or as deemed necessary.

Caution

1. For emergency action in the event of setting failure or leakage from the relief port, refer to "Troubleshooting" in the Operation Manual of the product.

ARJ

AR425
to 935

ARX

AMR

ARM

ARP

IR□-A

IR

IRV

VEX

SRH

SRP

SRF

ITV

IC

ITVH

ITVX

PVQ

VY1

VBA

VBAT

AP100