

Electro-Pneumatic Regulator/Electronic Vacuum Regulator

ITV Series

- Stepless control of air pressure proportional to an electrical signal
- ITV1000/2000/3000 series are compatible with various input specifications, including serial communications.



Serial communications specifications

Applicable Fieldbus protocols



Built-in communication board, so no converter needed.

RS-232C specification to serial communications is standardized.

Compact/lightweight (Integrated communication parts)

Weight: **350 g** ^{Note 1)} (ITV1000)

Power consumption: **4 w** ^{Note 1)} or less

Note 1) Value for communications type. (PROFIBUS DP)



Note 2) ITV1000. Dimensions in parentheses () are for the CC-Link or PROFIBUS DP.

Electro-Pneumatic Regulators

ITV0000 Series

Maximum flow rate
6 L/min (ANR)
Set pressure: 0.6 MPa
Supply pressure: 1.0 MPa



ITV1000 Series

Maximum flow rate
200 L/min (ANR)
Set pressure: 0.6 MPa
Supply pressure: 1.0 MPa
Grease-free specification (wetted parts)



ITV2000 Series

Maximum flow rate
1500 L/min (ANR)
Set pressure: 0.6 MPa
Supply pressure: 1.0 MPa



ITV3000 Series

Maximum flow rate
4000 L/min (ANR)
Set pressure: 0.6 MPa
Supply pressure: 1.0 MPa



Electronic Vacuum Regulators

ITV009□ Series



ITV209□ Series



ARJ
AR425 to 935
ARX
AMR
ARM
ARP
IR□-A
IR
IRV
VEX
SRH
SRP
SRF
ITV
IC
ITVH
ITVX
PVQ
VY1
VBA
VBAT
AP100

Compact Electro-Pneumatic Regulator *ITV0000 Series*

Compact Vacuum Regulator *ITV009□ Series*

Compact **15 mm**

With a simplified high-density circuit board design, an extremely compact size has been achieved.

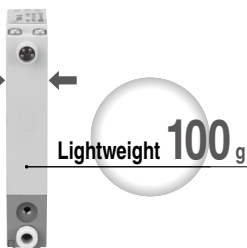

Lightweight **100 g**

Realizes space-saving and reduction of weight for manifold use.

Stations can easily be increased or decreased due to DIN rail mount design.



■ Cable connectors

Straight type and right angle type are available.

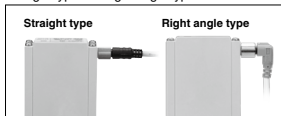

■ Built-in One-touch fittings

■ With error indication LED

■ Brackets

Flat and L-brackets are available.

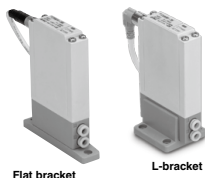

Flat bracket

L-bracket

● Equivalent to IP65

● Linearity: $\pm 1\%$ F.S. or less

Hysteresis: 0.5% F.S. or less

Repeatability: $\pm 0.5\%$ F.S. or less

● High-speed response time: **0.1 sec** (Without load)

(Note) This is not a guaranteed value as it depends on the operating environment.

● High stability

Sensitivity 0.2% F.S. or less

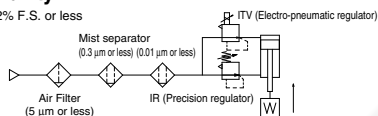

Electro-Pneumatic Regulator *ITV1000/2000/3000 Series*

Electronic Vacuum Regulator *ITV209□ Series*



ITV1000

ITV2000

ITV3000

ITV2090

Serial communications specifications to *ITV1000/2000/3000 series* are standardized.

● Reduced wiring

Applicable Fieldbus protocols



RS-232C specification to serial communications is standardized.

● Sensitivity: 0.2% F.S. or less

● Linearity: $\pm 1\%$ F.S. or less

● Hysteresis: 0.5% F.S. or less

● IP65

● Cable connections in 2 directions

Straight type

Right angle type



● Grease-free specification (ITV1000 series)

● Application examples

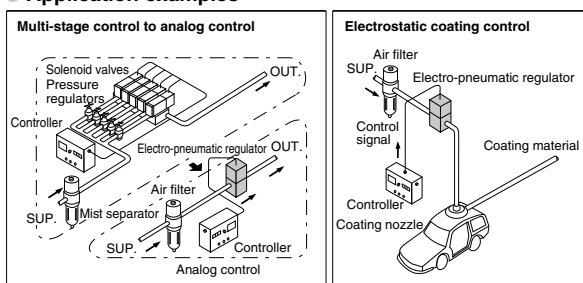











Electro-Pneumatic Regulator

Electronic Vacuum Regulator

ITV Series

● Stepless control of air pressure proportional to an electrical signal.

	Series	Model	Set pressure range	Input signal	Port size	Page	ARJ	
Electro-Pneumatic Regulator	ITV0000 Series	 ITV001□	0.001 to 0.1 MPa	Current type: 4 to 20 mA DC (Sink type) Current type: 0 to 20 mA DC (Sink type) Voltage type: 0 to 5 VDC Voltage type: 0 to 10 VDC	Built-in One-touch fittings Metric size: ø4 Inch size: ø5/32	896	AR425 to 935	
		ITV003□	0.001 to 0.5 MPa				ARX	
		ITV005□	0.001 to 0.9 MPa				AMR	
	ITV1000 Series	 	ITV101□	0.005 to 0.1 MPa	Current type: 4 to 20 mA DC (Sink type) Current type: 0 to 20 mA DC (Sink type) Voltage type: 0 to 5 VDC Voltage type: 0 to 10 VDC Preset input (4 points/16 points) 10 bit digital input CC-Link compatible	1/8, 1/4	904	ARM
		ITV103□	0.005 to 0.5 MPa	ARP				
		ITV105□	0.005 to 0.9 MPa	IR□-A				
	ITV2000 Series	 	ITV201□	0.005 to 0.1 MPa	Current type: 4 to 20 mA DC (Sink type) Current type: 0 to 20 mA DC (Sink type) Voltage type: 0 to 5 VDC Voltage type: 0 to 10 VDC Preset input (4 points/16 points) 10 bit digital input CC-Link compatible	1/4, 3/8	904	IR
		ITV203□	0.005 to 0.5 MPa	IRV				
		ITV205□	0.005 to 0.9 MPa	VEX				
ITV3000 Series	 	ITV301□	0.005 to 0.1 MPa	DeviceNet™ compatible PROFIBUS DP compatible RS-232C communication	1/4, 3/8, 1/2	904	SRH	
	ITV303□	0.005 to 0.5 MPa	SRP					
	ITV305□	0.005 to 0.9 MPa	SRF					
Electronic Vacuum Regulator	ITV009□ Series		ITV009□	-1 to -100 kPa	Current type: 4 to 20 mA DC (Sink type) Current type: 0 to 20 mA DC (Sink type) Voltage type: 0 to 5 VDC Voltage type: 0 to 10 VDC	Built-in One-touch fittings Metric size: ø4 Inch size: ø5/32	928	ITV
	ITV209□ Series	 	ITV209□	-1.3 to -80 kPa	Current type: 4 to 20 mA DC (Sink type) Current type: 0 to 20 mA DC (Sink type) Voltage type: 0 to 5 VDC Voltage type: 0 to 10 VDC Preset input (4 points/16 points) 10 bit digital input CC-Link compatible DeviceNet™ compatible PROFIBUS DP compatible RS-232C communication	1/4	935	IC

Compact Electro-Pneumatic Regulator

ITV0000 Series



How to Order

For single unit and single unit for manifold

ITV00 1 0 - 0 [] [] [] N

Pressure range

1	0.1 MPa
3	0.5 MPa
5	0.9 MPa

Power supply voltage

0	24 VDC ±10%
1	12 to 15 VDC

Input signal

0	Current type 4 to 20 mA DC (Sink type)
1	Current type 0 to 20 mA DC (Sink type)
2	Voltage type 0 to 5 VDC
3	Voltage type 0 to 10 VDC

Built-in One-touch fittings type

For single unit

Symbol	SUP ¹	OUT ²	EXH ³
Nil	Metric size (Light gray)	ø4	
U	Inch size (Orange)	ø5/32"	



For manifold

Symbol	SUP ¹	OUT ²	EXH ³	
Nil	Metric size (Light gray)	ø6	ø4	ø6
U	Inch size (Orange)	ø1/4"	ø5/32"	ø1/4"

Cable connector (Option)

N	Without cable connector
S	Straight type 3 m
L	Right angle type 2 m

Bracket/Option for single unit only

Nil	Without bracket
B	Flat Bracket 
C	L-bracket 

Base type

Nil	For single unit
M	For manifolds

Manifold

IITV00 - 02 [] - n

Stations

02	2 stations
03	3 stations
?	?
10	10 stations

Option
If a DIN rail longer than the specified stations is required, specify the applicable stations in two digits.
(Maximum 10 stations)
Example) IITV00-05-07

One-touch fitting size for supply/exhaust parts (End plate)

Nil	ø6 (Light gray)
U	ø1/4" (Orange)

Note) A DIN rail with the length specified by the number of stations is attached to the manifold. For dimensions of the DIN rail, refer to the external dimensions.

How to Order Manifold Assembly (Example)

Indicate the part numbers of electro-pneumatic regulators to be mounted below the manifold part number.

Example)
Due to the common supply/exhaust feature, note that different pressure range combinations are not available.

ITV00-03.....1 set (Manifold part no.)

*ITV0030-3MS.....2 sets (Electro-pneumatic regulator part no. (1, 2 stations))

*ITV0030-3ML.....1 set (Electro-pneumatic regulator part no. (3 stations))

Indicate part numbers in order starting from the first station on the D side.

Note) Combination with having different pressure ranges is not available due to common supply/exhaust features.

The asterisk (*) specifies mounting. Add an asterisk (*) at the beginning of electro-pneumatic regulator part numbers to be mounted.

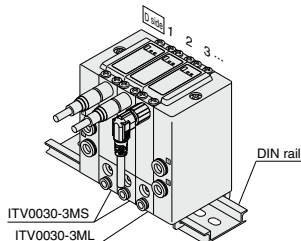

Specifications

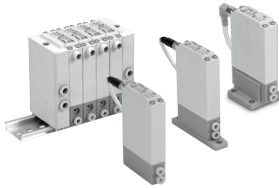

Model		ITV001□	ITV003□	ITV005□
Minimum supply pressure		Set pressure +0.1 MPa		
Maximum supply pressure		0.2 MPa	1.0 MPa	
Set pressure range		0.001 to 0.1 MPa	0.001 to 0.5 MPa	0.001 to 0.9 MPa
Power supply	Voltage	24 VDC ±10%, 12 to 15 VDC		
	Current consumption	Power supply voltage 24 VDC type: 0.12 A or less Power supply voltage 12 to 15 VDC type: 0.18 A or less		
Input signal	Voltage type	0 to 5 VDC, 0 to 10 VDC		
	Current type	4 to 20 mA DC, 0 to 20 mA DC (Sink type)		
Input impedance	Voltage type	Approx. 10 kΩ		
	Current type	Approx. 250 Ω		
Output signal ^{Note 4)}	Analog output	1 to 5 VDC (Output impedance: Approx. 1 kΩ) Output accuracy: ±6% F.S. or less		
Linearity		±1% F.S. or less		
Hysteresis		0.5% F.S. or less		
Repeatability		±0.5% F.S. or less		
Sensitivity		0.2% F.S. or less		
Temperature characteristics		±0.12% F.S./°C or less		
Operating temperature range		0 to 50°C (No condensation)		
Enclosure		Equivalent to IP65 *		
Connection type		Built-in One-touch fittings		
Connection size	For single unit	Metric size	①, ②, ③: ø4	
		Inch size	①, ②, ③: ø5/32"	
	Manifold	Metric size	①, ③: ø6, ②: ø4	
		Inch size	①, ③: ø1/4", ②: ø5/32"	
Weight ^{Note 1)}	100 g or less (without option)			

Note 1) Indicates the weight of a single unit.

For IITV00-n

Total weight (g) Stations (n) x 100 + 130 (Weight of end block A, B assembly) + Weight (g) of DIN rail

Note 2) When there is a downstream flow consumption, pressure may become unstable depending on piping conditions.

Note 3) When the input signal is at 0%, the exhaust solenoid valve is controlled to reduce the outlet pressure to zero. For this reason, a noise may be generated. This noise is normal and does not indicate a fault.

Note 4) When measuring ITV analog output from 1 to 5 VDC, if the load impedance is less than 100 kΩ, the analog output monitor accuracy of ±6% F.S. or less may not be available. The product with the accuracy of within ±6% is supplied upon your request. Output pressure remains unaffected.

* When using under the conditions equivalent to IP65, connect the fitting or tube to the breathing hole prior to use. (For details, refer to "Specific Product Precautions 1" on page 94.1.)

Accessories (Option)

Bracket

Flat bracket assembly (includes 2 mounting screws)
P39800022



L-bracket assembly (includes 2 mounting screws)
P39800023



Tightening torque when assembling is 0.3 N-m.

Cable connector

Straight type
M8-4DSX3MG4



Right angle type
P398000-501-2



ITV0000 Series

Working Principle

When the input signal rises, the air supply solenoid valve ① turns ON. Due to this, part of the supply pressure passes through the air supply solenoid valve ① and changes to output pressure. This output pressure feeds back to the control circuit ④ via the pressure sensor ③. Here, pressure corrections continue until output pressure becomes proportional to the input signal, enabling output pressure that is proportional to the input signal.

Working Principle Diagram

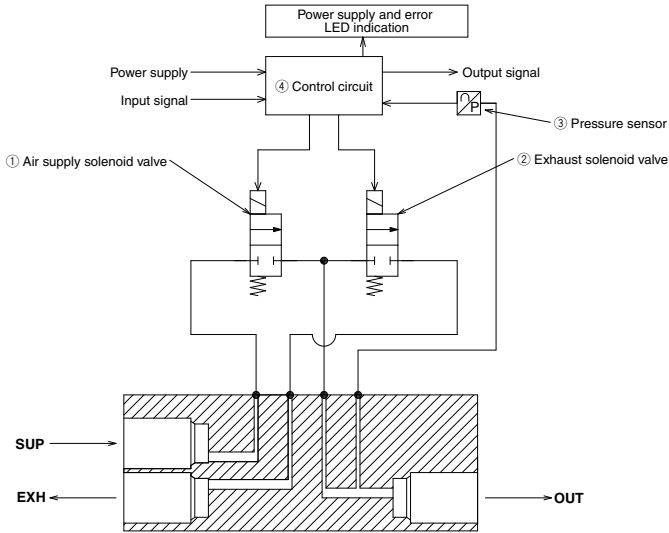

Block Diagram

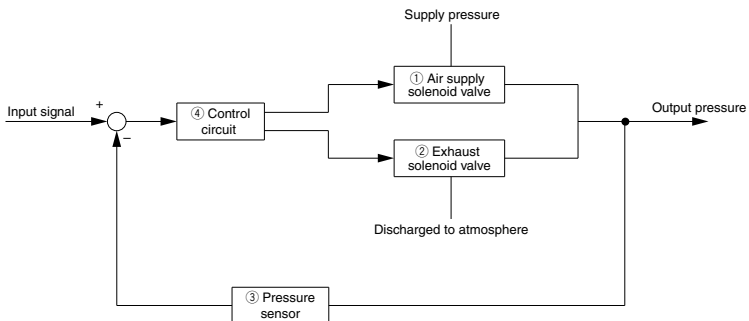

ITV001 Series

Linearity, Hysteresis

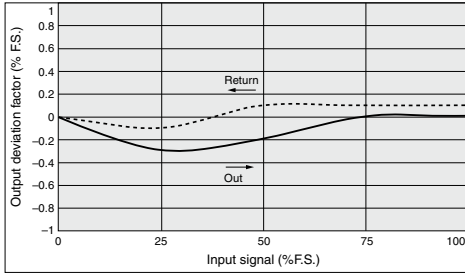

Repeatability

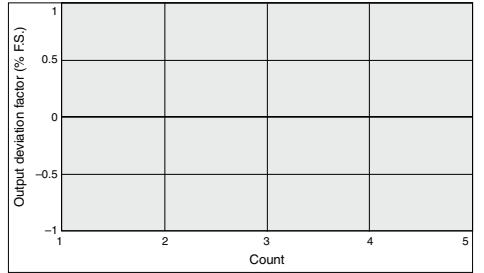

Pressure Characteristics

Set pressure: 0.05 MPa

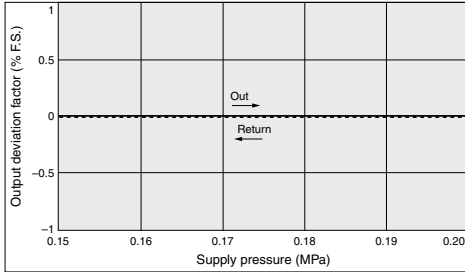

Flow Rate Characteristics

Supply pressure: 0.2 MPa

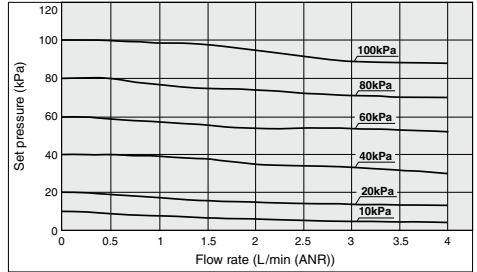

ITV003 Series

Linearity, Hysteresis

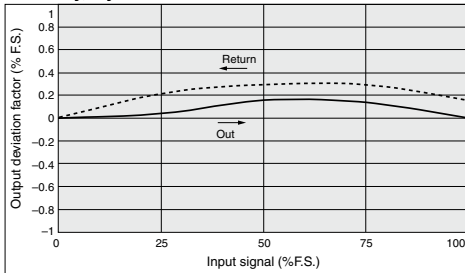

Repeatability

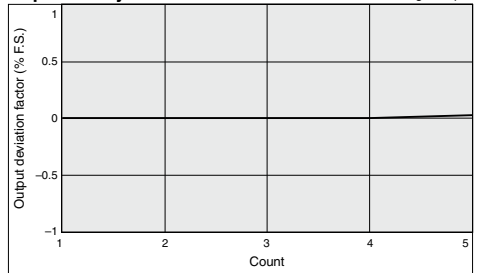

Pressure Characteristics

Set pressure: 0.25 MPa

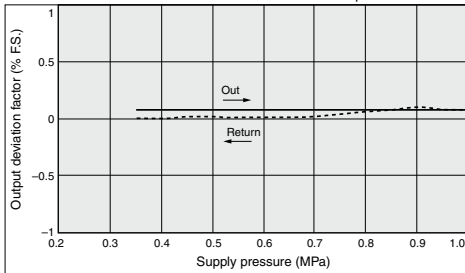

Flow Rate Characteristics

Supply pressure: 0.6 MPa

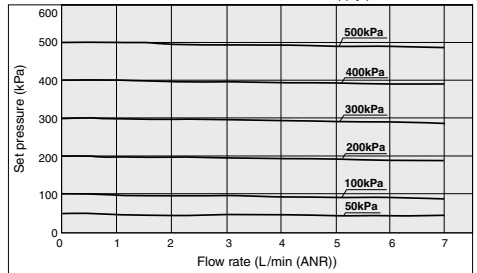

ARJ

AR425
to 935

ARX

AMR

ARM

ARP

IR□-A

IR

IRV

VEX

SRH

SRP

SRF

ITV

IC

ITVH

ITVX

PVQ

VY1

VBA

VBAT

AP100

ITV0000 Series

ITV005□ Series

Linearity, Hysteresis

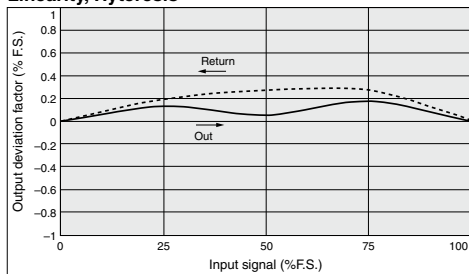

Repeatability

With 50% of signal input

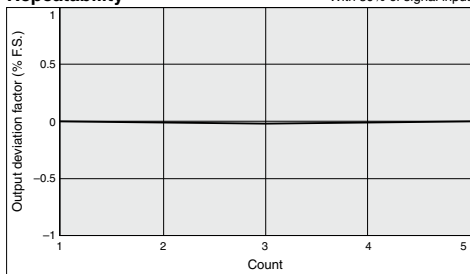

Pressure Characteristics

Set pressure: 0.45 MPa

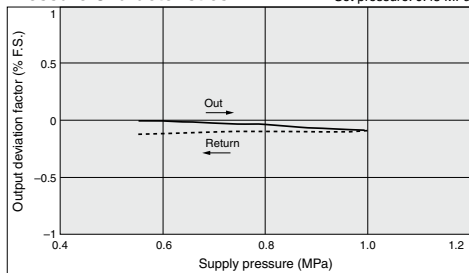

Flow Rate Characteristics

Supply pressure: 1.0 MPa

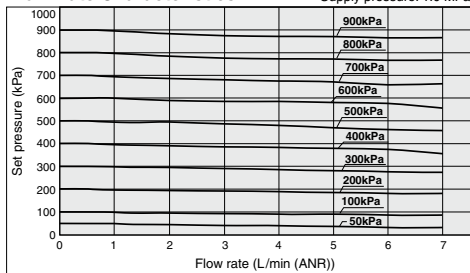

Dimensions

For Single Unit

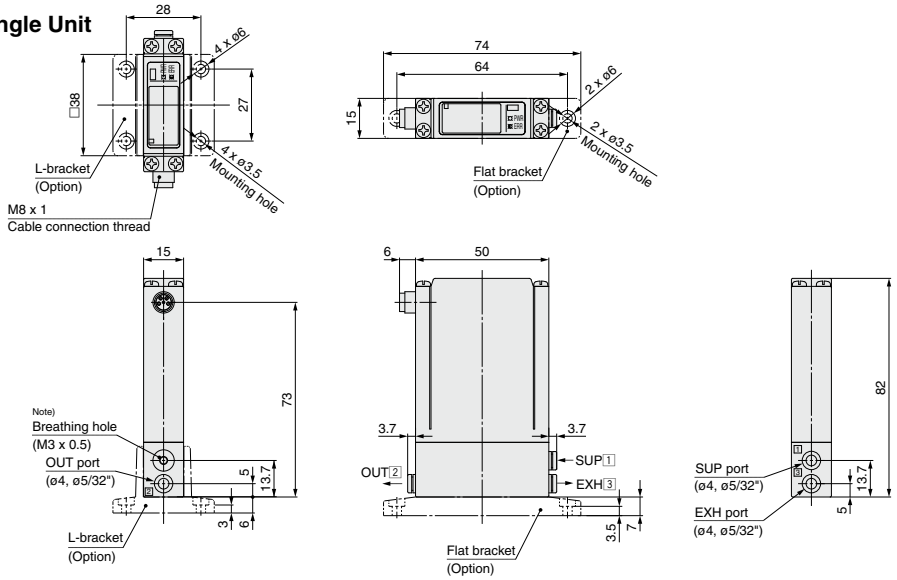

Port Location

No.	1	2	3
ITV003	SUP	OUT	EXH
5			

Note) When using under the conditions equivalent to IP65, connect the fittings or tube to the breathing hole prior to use.
(For details, refer to "Specific Product Precautions 1" on page 941.)

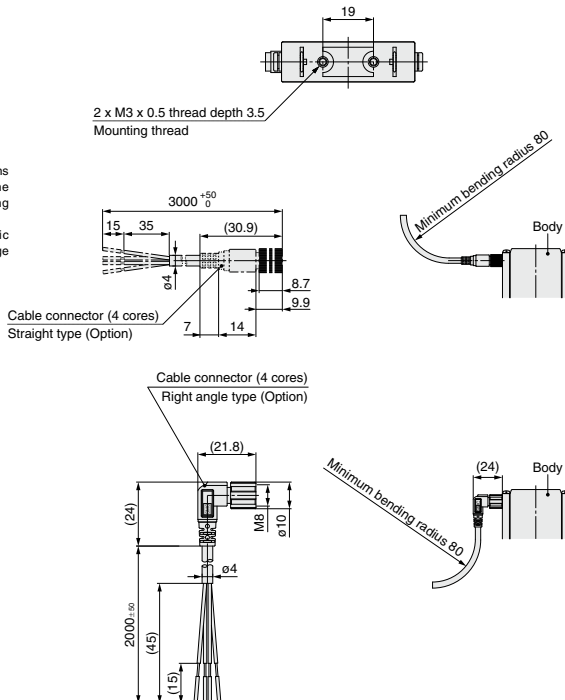

ARJ

AR425
to 935

ARX

AMR

ARM

ARP

IR□-A

IR

IRV

VE X

SRH

SRP

SRF

ITV

IC

ITVH

ITVX

PVQ

VY1

VBA

VBAT

AP100

ITV0000 Series

Dimensions

Single unit for manifold

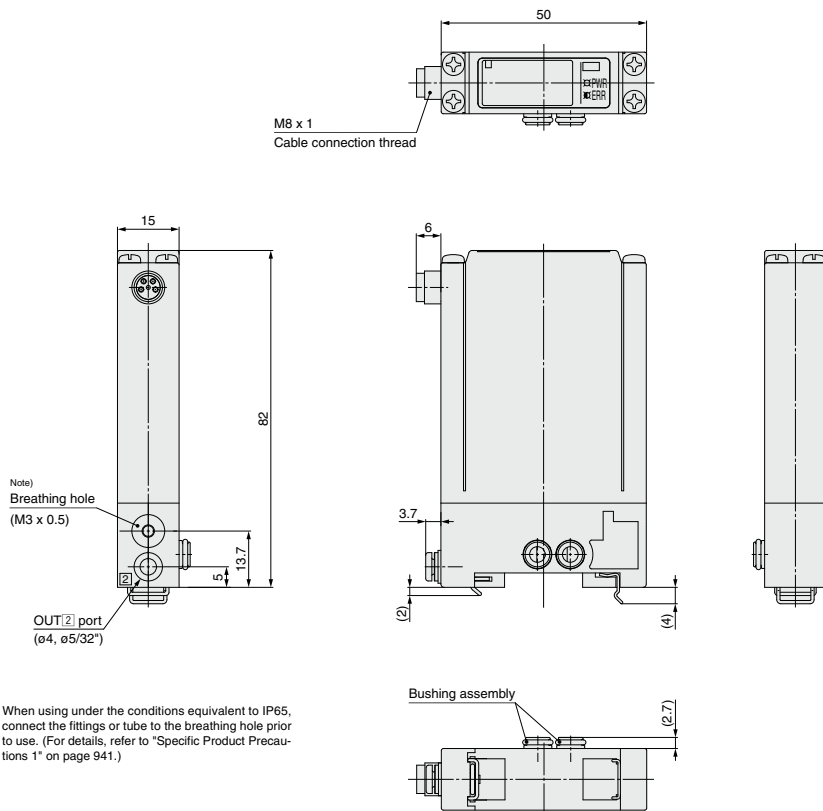

Note) When using under the conditions equivalent to IP65, connect the fittings or tube to the breathing hole prior to use. (For details, refer to "Specific Product Precautions 1" on page 941.)

Note) For dimensions of the cable connector, refer to single unit on page 901.

Dimensions

Manifold

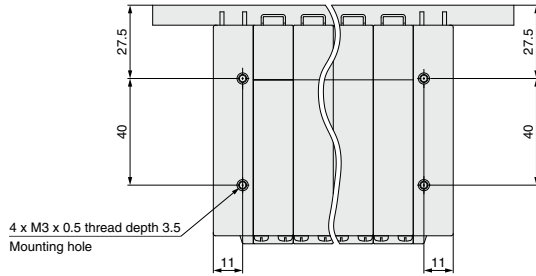

Port Location

No.	1	2	3
ITV003□	SUP	OUT	EXH
5			

Note) Stations are counted starting from the D side.

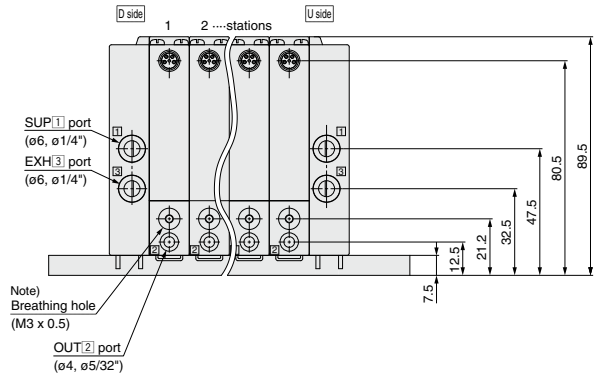
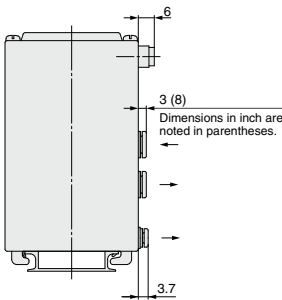
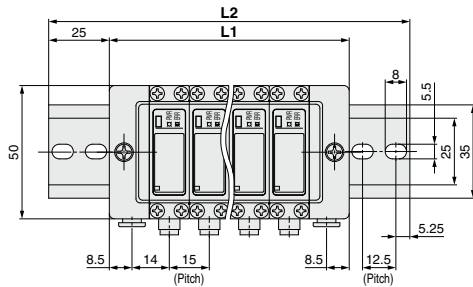

Note) For dimensions of the cable connector, refer to single unit on page 901.

Note) When using under the conditions equivalent to IP65, connect the fittings or tubing to the breathing hole prior to use.
(For details, refer to "Specific Product Precautions 1" on page 941.)

Manifold stations n	(mm)									
	2	3	4	5	6	7	8	9	10	
L1	60	75	90	105	120	135	150	165	180	
L2	110.5	123	148	160.5	173	185.5	198	223	235.5	
Weight of DIN rail (g)	20	22	27	29	31	34	36	41	43	

ARJ
AR425 to 935
ARX
AMR
ARM
ARP
IR□-A
IR
IRV
VEV
SRH
SRP
SRF
ITV
IC
ITVH
ITVX
PVQ
VY1
VBA
VBAT
AP100

Electro-Pneumatic Regulator

ITV1000/2000/3000 Series



How to Order

ITV **3** **0** **1** **0** - **0** **1** **2** **S** -

Model

1	1000 type
2	2000 type
3	3000 type

Pressure range

1	0.1 MPa
3	0.5 MPa
5	0.9 MPa

Power supply voltage

0	24 VDC
1	12 to 15 VDC

Note) Communication models (CC, DE, PR, RC), 16 points preset input and 10 bit digital input are available only for 24 VDC.

• **Made to Order Specifications**
Refer to pages 906, 922, and 923 for details.

Pressure display unit

Nil	MPa
2 ⁽¹⁰⁰⁾	kgf/cm ²
3	bar
4 ⁽¹⁰⁰⁾	psi
5	kPa

Note) Under Japan's new Measurement Act, this is only for overseas sales (SI units are to be used inside Japan). For the communication models, CC, DE, PR and RC, only "Nil" is available as it does not have a pressure display.

Input signal/ Communication model

0	Current type 4 to 20 mA DC (Sink type)
1	Current type 0 to 20 mA DC (Sink type)
2	Voltage type 0 to 5 VDC
3	Voltage type 0 to 10 VDC
40	4 points preset input
52	16 points preset input (Switch output/NPN output)
53	16 points preset input (Switch output/PNP output)
60	10 bit digital input
CC	CC-Link
DE	DeviceNet™
PR	PROFIBUS DP
RC	RS-232C communication

Monitor output

1	Analog output 1 to 5 VDC
2	Switch output/NPN output
3	Switch output/PNP output
4	Analog output 4 to 20 mA DC (Sink type)
Nil	None

Thread type

Nil	Rc
N	NPT
T	NPTF
F	G

Cable connector type

S	Straight type 3 m
L	Right angle type 3 m
N	Without cable connector

Note) Even when a cable connector is selected, communication cable is not included in the communication models, CC, DE and PR. Please order it separately. Refer to the below.
For 10 bit digital input, right angle type cannot be selected.

Bracket *

Nil	Without bracket
B	Flat bracket
C	L-bracket

* Bracket is included.

Port size

1	1/8 (1000 type)
2	1/4 (1000, 2000, 3000 type)
3	3/8 (2000, 3000 type)
4	1/2 (3000 type)

For communication cables, use the parts listed below (refer to M8/M12 connector in Best Pneumatics No.1-1 for details) or order the product certified for the respective protocol (with M12 connector) separately.

Application	Communication cable part number	Note
CC-Link compatibility	PCA-1567720 (Socket type)	Dedicated Bus adapter supplied with the product.
	PCA-1567717 (Plug type)	
DeviceNet™ compatibility	PCA-1557633 (Socket type)	T-branch connector not supplied.
	PCA-1557646 (Plug type)	
PROFIBUS DP compatibility	PCA-1557688 (Socket type) PCA-1557691 (Plug type)	T-branch connector not supplied.

Standard Specifications

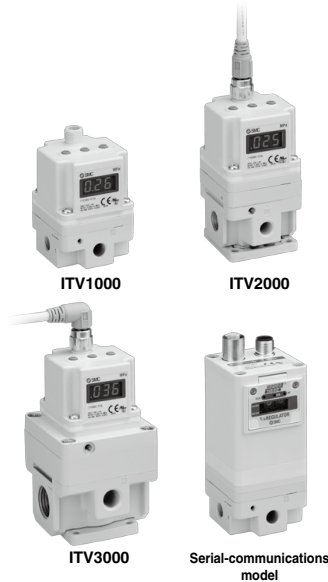

Symbol

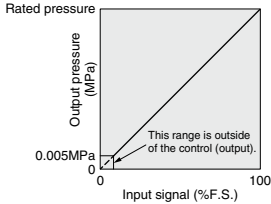
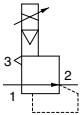

Figure 1. Input/output characteristics chart

Model	ITV101□ ^{Note 8)}	ITV103□ ^{Note 8)}	ITV105□ ^{Note 8)}
	ITV201□	ITV203□	ITV205□
	ITV301□	ITV303□	ITV305□
Minimum supply pressure	Set pressure +0.1 MPa		
Maximum supply pressure	0.2 MPa	1.0 MPa	
Set pressure range ^{Note 1)}	0.005 to 0.1 MPa	0.005 to 0.5 MPa	0.005 to 0.9 MPa
Power supply	Voltage 24 VDC ± 10%, 12 to 15 VDC		
	Current consumption Power supply voltage 24 VDC type: 0.12 A or less ^{Note 9)} Power supply voltage 12 to 15 VDC type: 0.18 A or less		
Input signal ^{Note 9)}	Current type ^{Note 2)} 4 to 20 mA DC, 0 to 20 mA DC (Sink type)		
	Voltage type 0 to 5 VDC, 0 to 10 VDC		
	Preset input 4 points (Negative common), 16 points (No common polarity)		
Input impedance	Digital input 10 bit (Parallel)		
	Current type 250 Ω or less ^{Note 6)}		
	Voltage type Approx. 6.5 kΩ		
Output signal (monitor output) ^{Note 3)}	Preset input Power supply voltage 24 VDC type: Approx. 4.7 kΩ Power supply voltage 12 VDC type: Approx. 2.0 kΩ		
	Digital input Approx. 4.7 kΩ		
	Analog output 1 to 5 VDC (Output impedance: Approx. 1 kΩ) 4 to 20 mA DC (Sink type) (Output impedance: 250 Ω or less) Output accuracy ± 6% F.S. or less		
Linearity	Switch output NPN open collector output: Max. 30 V, 80 mA PNP open collector output: Max. 80 mA		
	± 1% F.S. or less		
Hysteresis	± 0.5% F.S. or less		
Repeatability	± 0.5% F.S. or less		
Sensitivity	± 0.2% F.S. or less		
Temperature characteristics	± 0.12% F.S./°C or less		
Output pressure display ^{Note 4)}	Accuracy ± 2% F.S. ± 1 digit or less		
	Minimum unit	MPa: 0.001, kgf/cm ² : 0.01, bar: 0.01, psi: 0.1 ^{Note 5)} , kPa: 1	
Ambient and fluid temperature	0 to 50°C (No condensation)		
Enclosure	IP65		
Weight ^{Note 10)}	ITV10□□	Approx. 250 g (without options)	
	ITV20□□	Approx. 350 g (without options)	
	ITV30□□	Approx. 645 g (without options)	

- Note 1) Please refer to Figure 1 for the relationship between set pressure and input. Because the maximum set pressure differs for each pressure display, refer to page 945.
 Note 2) 2-wire type 4 to 20 mA DC is not available. Power supply voltage (24 VDC or 12 to 15 VDC) is required.
 Note 3) Select either analog output or switch output.
 Further, when switch output is selected, select either NPN output or PNP output.
 When measuring ITV analog output from 1 to 5 VDC, if the load impedance is less than 100 kΩ, the analog output monitor accuracy of within ±6% (full span) may not be available. The product with the accuracy of within ±6% is supplied upon your request. Output pressure remains unaffected.
 Note 4) Adjustment of numerical values such as the zero/span adjustment or preset input type is set based on the minimum units for output pressure display (e.g. 0.001 to 0.500 MPa). Note that the unit cannot be changed.
 Note 5) The minimum unit for 0.9 MPa (130 psi) types is 1 psi.
 Note 6) Value for the state with no over current circuit included. If an allowance is provided for an over current circuit, the input impedance varies depending on the input current. This is 350 Ω or less for an input current of 20 mA DC.
 Note 7) The above characteristics are confined to the static state. When air is consumed on the output side, the pressure may fluctuate.
 Note 8) The ITV1000 series is a Grease-free specification (Wetted parts).
 Note 9) Refer to the table below for communication specifications.
 Note 10) Add 50 g for digital input type, 70 g for 16 points preset input type respectively.

Communication Specifications (CC, DE, PR, RC)

Model	ITV□□□-CC	ITV□□□-DE	ITV□□□-PR	ITV□□□-RC
Protocol	CC-Link	DeviceNet™	PROFIBUS DP	RS-232C
Version ^{Note 1)}	Ver 1.10	Volume1 (Edition3.8), Volume3 (Edition1.5)	DP-V0	—
Communication speed	156 k/625 k 2.5 M/5 M/10 M bps	125 k/250 k/500 k bps	9.6 k/19.2 k/45.45 k 93.75 k/187.5 k/500 k 1.5 M/3 M/6 M/12 M bps	9.6 kbps
Configuration file ^{Note 2)}	—	EDS	GSD	—
I/O occupation area (Input/output data)	4 word/4 word, 32 bit/32 bit (per station, remote device station)	16 bit/16 bit	16 bit/16 bit	—
Communication data resolution	12 bit (4096 resolution)	12 bit (4096 resolution)	12 bit (4096 resolution)	10 bit (1024 resolution)
Fail safe	HOLD ^{Note 3)} /CLEAR (Switch setting)	HOLD/CLEAR (Switch setting)	CLEAR	HOLD
Electric insulation ^{Note 4)}	Insulation	Insulation	Insulation	Non-insulation
Terminating resistor	Built into the product (Switch setting)	Not built into the product	Built into the product (Switch setting)	—
Current consumption	0.16 A or less	0.14 A or less	0.16 A or less	0.12 A or less
Weight	ITV1000	330	320	320
	ITV2000	430	420	420
	ITV3000	730	720	720

- Note 1) Note that version information is subject to change.
 Note 2) Configuration files can be downloaded from the operation manual page on SMC's website: <http://www.smworld.com>
 Note 3) The output HOLD value when a CC-Link communications error occurs can be set based on the bit area data.
 Note 4) The insulation between the electrical signal of the communication system and ITV power supply.

ARJ
AR425 to 935
ARX
AMR
AMR
ARMP
IR□-A
IR
IRV
VEX
SRH
SRP
SRF
ITV
IC
ITVH
ITVX
PVQ
VY1
VBA
VBAT
AP100

ITV1000/2000/3000 Series

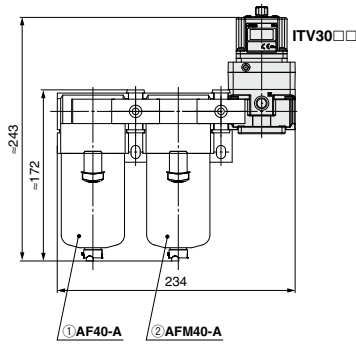
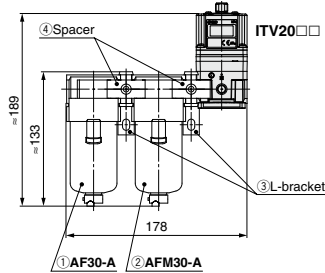

Made to Order

(Refer to pages 922 to 926 for details.)

Symbol	Specifications
X102	Reverse type
X224	High pressure type (SUP 1.2 MPa, OUT 1.0 MPa)
X25	Set pressure range 1 to 100 kPa (Except ITV3000 series)
X88	High speed response type (Except ITV3000 series)
X26	For manifold mounting (Except ITV3000 series)
X410	Linearity: $\pm 0.5\%$ F.S. or less
X420	With alarm output

Note 1) Manifolds are compatible with 2 to 8 stations. Consult with SMC for 9 stations or more.

Note 2) Products without symbols are also compatible. Consult with SMC separately.

Note 3) Compliant with CE marking

Model	Bracket tightening torque
ITV1000	0.76 ± 0.05 N·m
ITV2000/3000	1.5 ± 0.05 N·m

Modular Products and Accessory Combinations

Applicable products and accessories	Applicable model	
	ITV2000	ITV3000
① Air filter	AF30-A	AF40-A
② Mist separator	AFM30-A	AFM40-A
③ L-bracket	B310L-A	B410L-A
④ Spacer	Y30-A	Y40-A
⑤ Spacer with L-bracket (③ + ④)	Y30L-A	Y40L-A
⑥ Spacer with T-bracket	—	Y40T-A

* For ITV1000, use a modular adapter (Refer to page 643 for details).

Accessories (Option)/Part No.

[Bracket]

Applicable model	Description	Part No.
ITV1000	Flat bracket assembly (including mounting screws)	P398010-600
ITV2000, 3000		P398020-600
ITV1000	L-bracket assembly (including mounting screws)	P398010-601
ITV2000, 3000		P398020-601

[Cable connector]

Applicable model	Description		Part No.
Current type Voltage type 4 points preset input	Cable connector (4 cores)	Straight type 3 m	P398020-500-3
		Right angle type 3 m	P398020-501-3
16 points preset input	Power cable (4 cores)	Straight type 3 m	P398020-500-3
		Right angle type 3 m	P398020-501-3
	Signal cable (5 cores)	Straight type 3 m	P398020-502-3
		Right angle type 3 m	P398020-503-3
10 bit digital input	Cable connector (13 cores)	Straight type 3 m	INI-398-0-59
CC-Link PROFIBUS DP DeviceNet™	Power cable (4 cores)	Straight type 3 m	P398020-500-3
		Right angle type 3 m	P398020-501-3
RS-232C	Power cable (4 cores)	Straight type 3 m	P398020-500-3
		Right angle type 3 m	P398020-501-3
	Communication cables connector (5 cores)	Straight type 3 m	P398020-502-3
		Right angle type 3 m	P398020-503-3

Note 1) For the 10-bit digital type, there is no right angle type cable connector.

Note 2) Even when "with cable connector" is selected the communication cable is not included in the communication model (CC, DE, PR). Please order separately.

[Bus adapter]

Applicable model	Description	Part No.
CC-Link	Bus adapter (Bus adapter supplied with the product.)	EX9-ACY00-MJ

Dimensions

Flat bracket

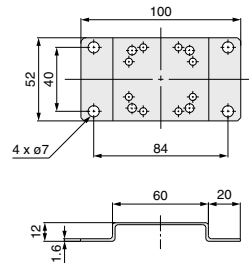

L-bracket

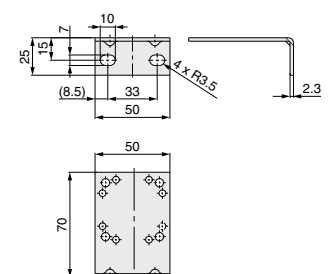

Working Principles

When the input signal rises, the air supply solenoid valve ① turns ON, and the exhaust solenoid valve ② turns OFF. Therefore, supply pressure passes through the air supply solenoid valve ① and is applied to the pilot chamber ③. The pressure in the pilot chamber ③ increases and operates on the upper surface of the diaphragm ④.

As a result, the air supply valve ⑤ linked to the diaphragm ④ opens, and a portion of the supply pressure becomes output pressure.

This output pressure feeds back to the control circuit ⑧ via the pressure sensor ⑦. Here, a correct operation functions until the output pressure is proportional to the input signal, making it possible to always obtain output pressure proportional to the input signal.

Working Principle Diagram

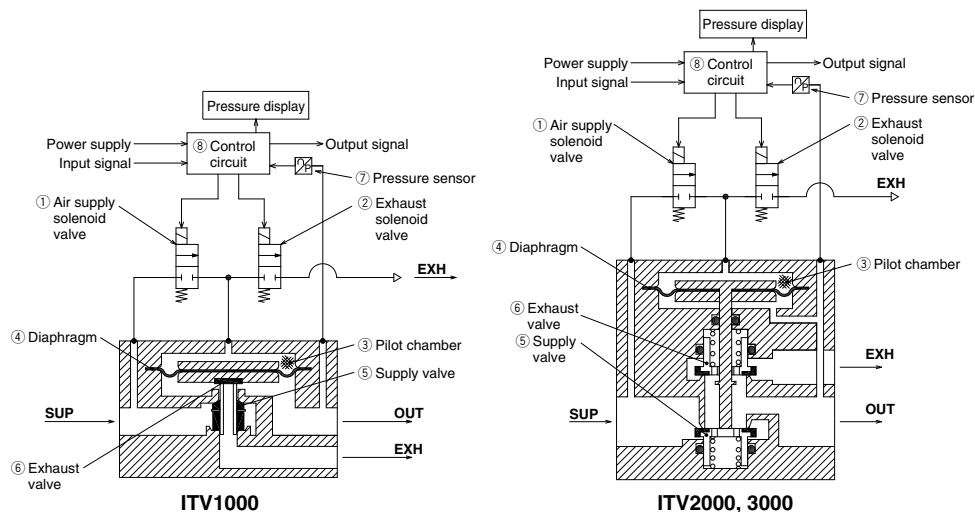

Block Diagram

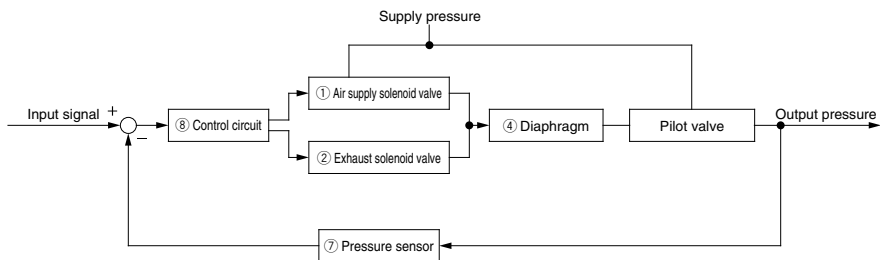

ARJ

AR425
to 935

ARX

AMR

ARM

ARP

IR□-A

IR

IRV

VE X

SRH

SRP

SRF

ITV

IC

ITVH

ITVX

PVQ

VY1

VBA

VBAT

AP100

ITV1000/2000/3000 Series

ITV101 Series

Linearity

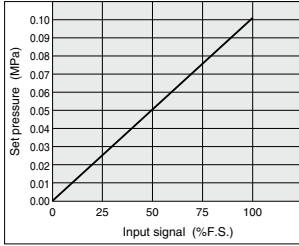

Hysteresis

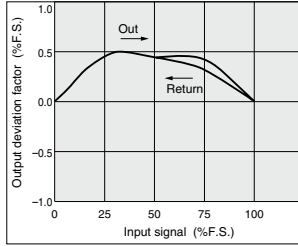

Repeatability

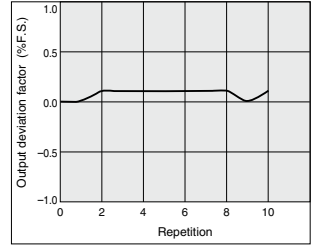

Pressure characteristics Set pressure: 0.05 MPa

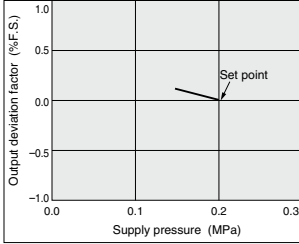

Flow rate characteristics Supply pressure: 0.2 MPa

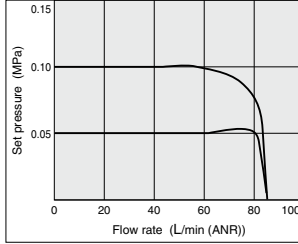

Relief flow characteristics Supply pressure: 0.2 MPa

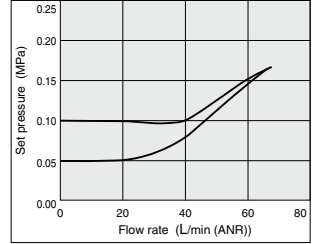

ITV201 Series

Linearity

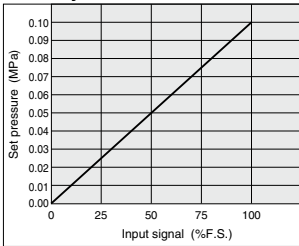

Hysteresis

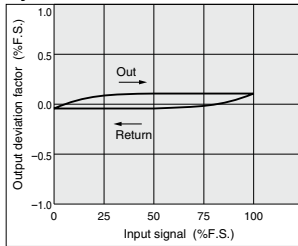

Repeatability

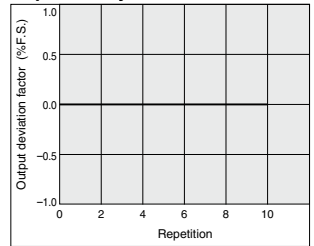

Pressure characteristics Set pressure: 0.05 MPa

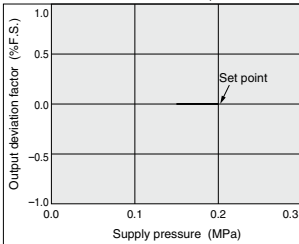

Flow rate characteristics Supply pressure: 0.2 MPa

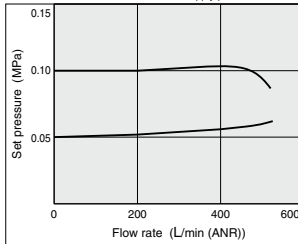

Relief flow characteristics Supply pressure: 0.2 MPa

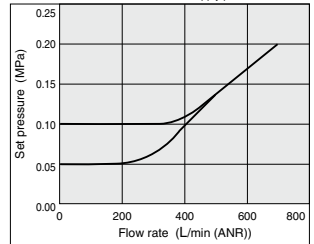

ITV301 Series

Linearity

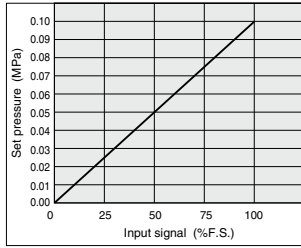

Hysteresis

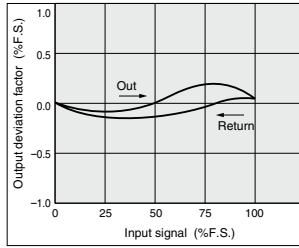

Repeatability

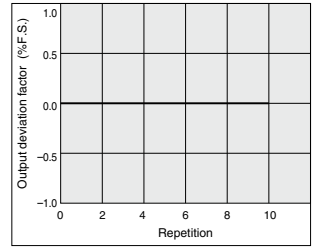

Pressure characteristics Set pressure: 0.05 MPa

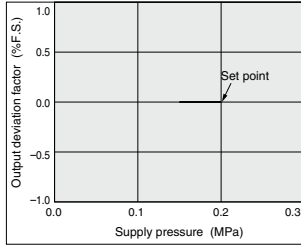

Flow rate characteristics Supply pressure: 0.2 MPa

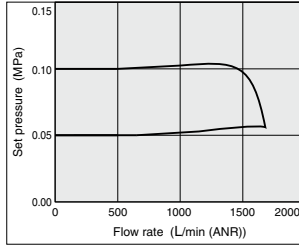

Relief flow characteristics Supply pressure: 0.2 MPa

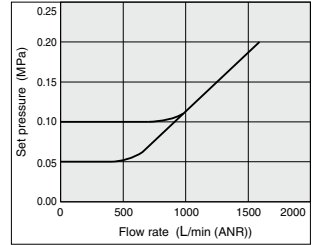

ARJ

AR425
to 935

ARX

AMR

ARM

ARP

IR□-A

IR

IRV

VEX

SRH

SRP

SRF

ITV

IC

ITVH

ITVX

PVQ

VY1

VBA
VBAT

AP100

ITV1000/2000/3000 Series

ITV103 Series

Linearity

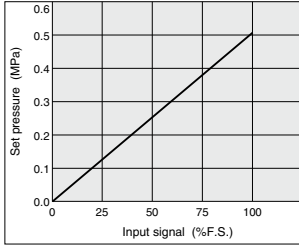

Hysteresis

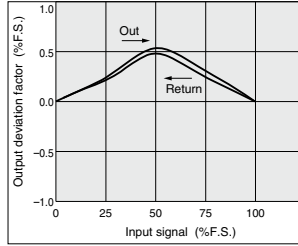

Repeatability

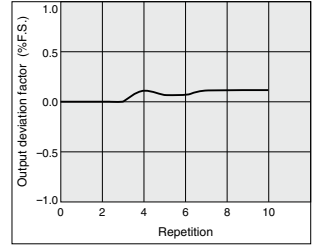

Pressure characteristics Set pressure: 0.2 MPa

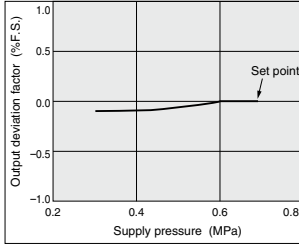

Flow rate characteristics Supply pressure: 0.7 MPa

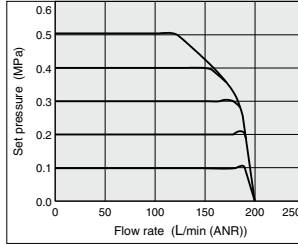

Relief flow characteristics Supply pressure: 0.7 MPa

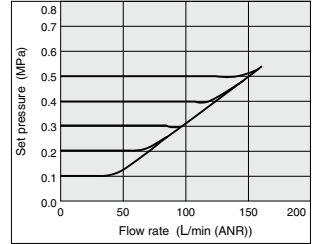

ITV203 Series

Linearity

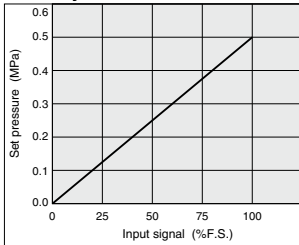

Hysteresis

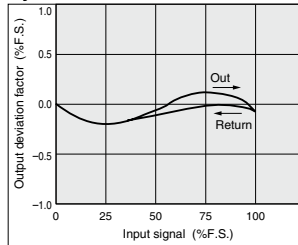

Repeatability

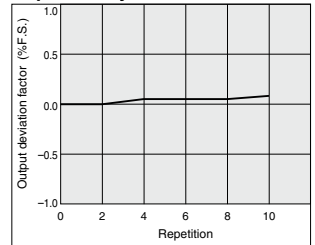

Pressure characteristics Set pressure: 0.2 MPa

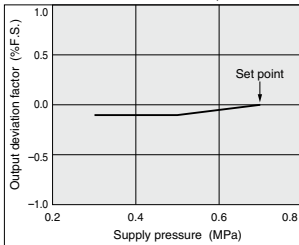

Flow rate characteristics Supply pressure: 0.7 MPa

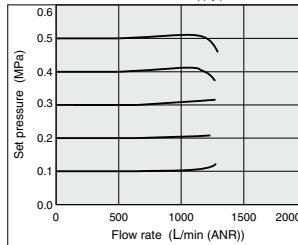

Relief flow characteristics Supply pressure: 0.7 MPa

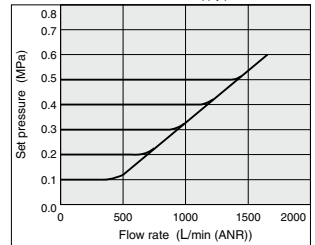

ITV303 Series

Linearity

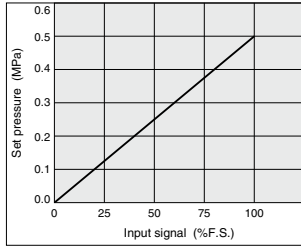

Hysteresis

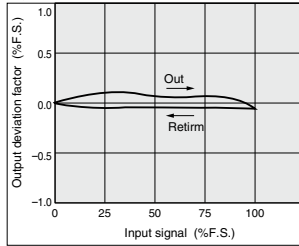

Repeatability

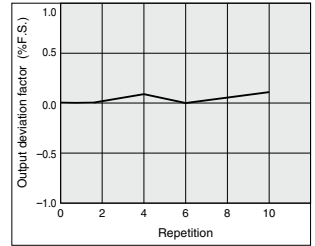

Pressure characteristics Set pressure: 0.2 MPa

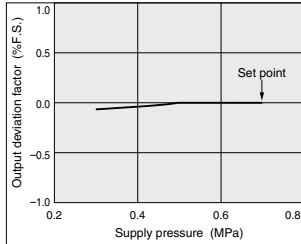

Flow rate characteristics Supply pressure: 0.7 MPa

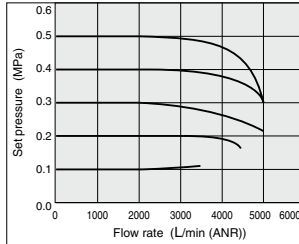

Relief flow characteristics Supply pressure: 0.7 MPa

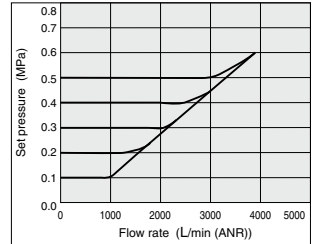

ARJ

AR425
to 935

ARX

AMR

ARM

ARP

IR -A

IR

IRV

VEX

SRH

SRP

SRF

ITV

IC

ITVH

ITVX

PVQ

VY1

VBA
VBAT

AP100

ITV1000/2000/3000 Series

ITV105 Series

Linearity

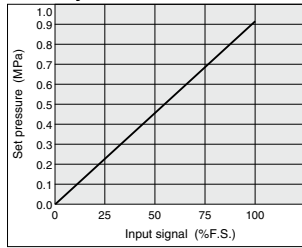

Hysteresis

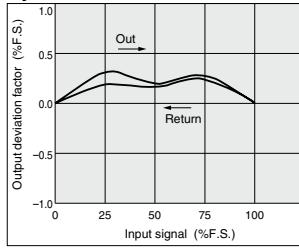

Repeatability

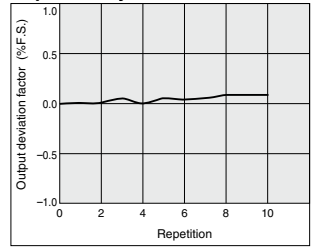

Pressure characteristics

Set pressure: 0.4 MPa

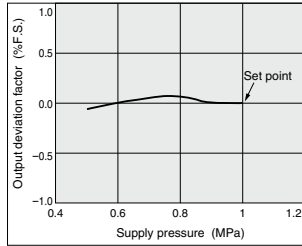

Flow rate characteristics

Supply pressure: 1.0 MPa

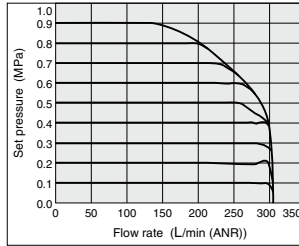

Relief flow characteristics

Supply pressure: 1.0 MPa

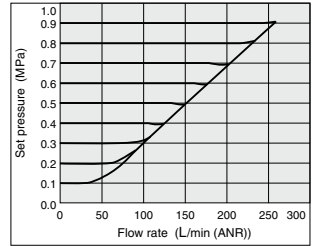

ITV205 Series

Linearity

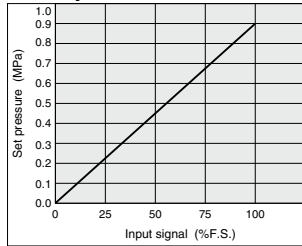

Hysteresis

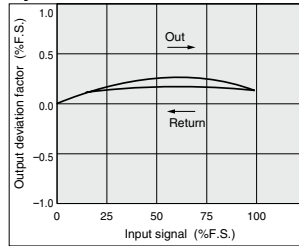

Repeatability

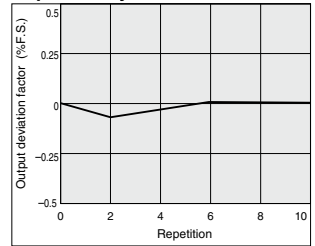

Pressure characteristics

Set pressure: 0.4 MPa

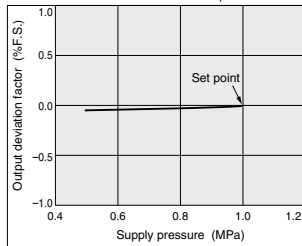

Flow rate characteristics

Supply pressure: 1.0 MPa

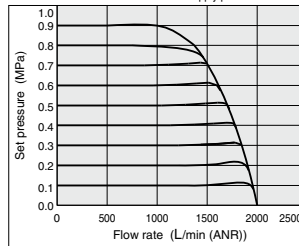

Relief flow characteristics

Supply pressure: 1.0 MPa

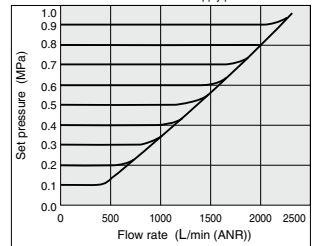

ITV305 Series

Linearity

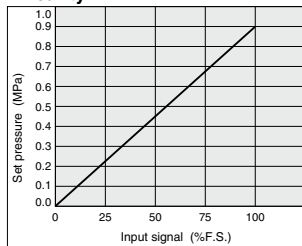

Hysteresis

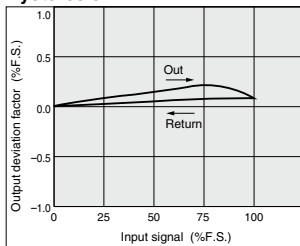

Repeatability

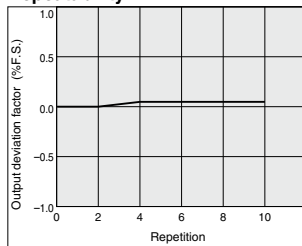

Pressure characteristics Set pressure: 0.4 MPa

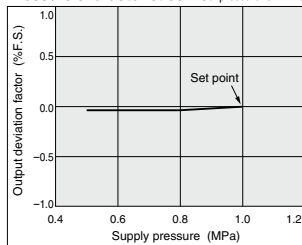

Flow rate characteristics Supply pressure: 1.0 MPa

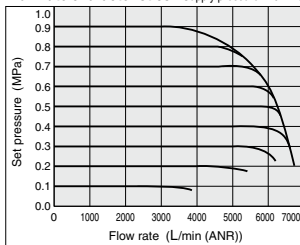

Relief flow characteristics Supply pressure: 1.0 MPa

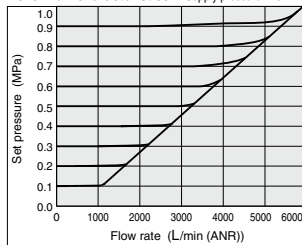

ARJ

AR425
to 935

ARX

AMR

ARM

ARP

IR -A

IR

IRV

VEV

SRH

SRP

SRF

ITV

IC

ITVH

ITVX

PVQ

VY1

VBA

VBAT

AP100

ITV1000/2000/3000 Series

Construction

ITV1000

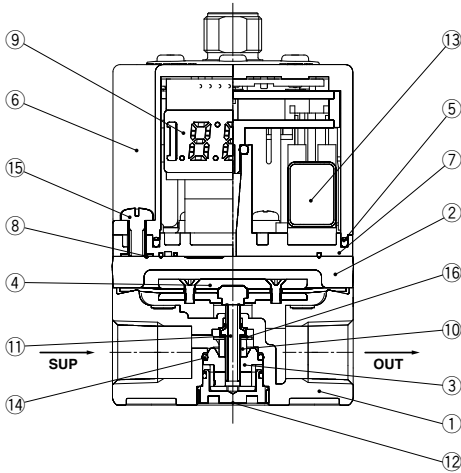

Main Component Parts

No.	Description	Material
◆ 1	Body	Aluminum alloy
2	Cover	Aluminum alloy
◆ 3	Valve guide	Resin
◆ 4	Diaphragm assembly	Aluminum alloy
		Weather resistant NBR
5	Seal	Steel
6	Bowl assembly	NBR
7	Sub-plate	Resin
8	Seal	Silicone rubber
9	Control circuit assembly	Resin
◆ 10	Bumper	—
◆ 11	Valve	NBR
		Stainless steel
◆ 12	Guide retainer	HNBR
◆ 13	Solenoid valve	Aluminum alloy
◆ 14	O-ring	—
◆ 15	Round head phillips screw	HNBR
◆ 16	Flat washer	Steel

* Parts in contact with fluid are indicated with a mark ◆.

ITV2000

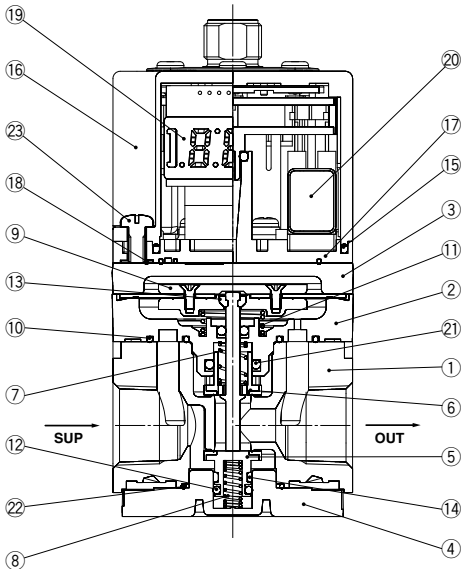

Main Component Parts

No.	Description	Material
◆ 1	Body	Aluminum alloy
◆ 2	Intermediate body	Aluminum alloy
3	Cover	Aluminum alloy
◆ 4	Valve guide	Aluminum alloy
◆ 5	Valve (Supply valve)	Stainless steel
◆ 6	Valve (Exhaust valve)	HNBR/Brass
◆ 7	Valve spring	Stainless steel
◆ 8	Valve spring	Stainless steel
◆ 9	Diaphragm assembly	Stainless steel
		Aluminum alloy
		Weather resistant NBR
◆ 10	Seal	Steel
◆ 11	Bias spring	NBR
◆ 12	O-ring	Stainless steel
◆ 13	Cotter	NBR
◆ 14	Wear ring	Stainless steel
◆ 15	Seal	Resin
16	Bowl assembly	NBR
17	Sub-plate	Silicone rubber
18	Seal	Resin
19	Control circuit assembly	NBR
20	Solenoid valve	—
◆ 21	O-ring	NBR
◆ 22	O-ring	NBR
◆ 23	Round head phillips screw	Steel

* Parts in contact with fluid are indicated with a mark ◆.

Construction

ITV3000

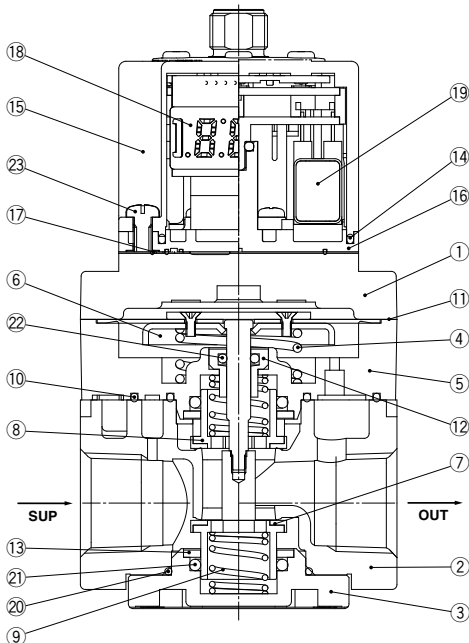

Main Component Parts

No.	Description	Material
1	Cover	Aluminum alloy
2	Body	Aluminum alloy
◆ 3	Valve guide	Aluminum alloy
◆ 4	Bias spring	Stainless steel
◆ 5	Intermediate body	Aluminum alloy
◆ 6	Diaphragm assembly	Weather resistant NBR
		Rolled sheet steel
		Stainless steel
		Aluminum alloy
		Steel
◆ 7	Valve (Supply valve)	HNBR/Brass
◆ 8	Valve (Exhaust valve)	HNBR/Brass
◆ 9	Valve spring	Stainless steel
◆ 10	Seal	NBR
◆ 11	Seal	NBR
◆ 12	Rod guide	Brass
◆ 13	O-ring retainer	Aluminum alloy
◆ 14	Seal	NBR
15	Bowl assembly	Resin
		Silicone rubber
16	Sub-plate	Resin
17	Seal	NBR
18	Control circuit assembly	—
19	Solenoid valve	—
◆ 20	O-ring	NBR
◆ 21	O-ring	NBR
◆ 22	O-ring	NBR
23	Round head Phillips screw	Steel

* Parts in contact with fluid are indicated with a mark ◆.

ARJ

AR425
to 935

ARX

AMR

ARM

ARP

IR□-A

IR

IRV

VEV

SRH

SRP

SRF

ITV

IC

ITVH

ITVX

PVQ

VY1

VBA

VBAT

AP100

ITV1000/2000/3000 Series

Dimensions

ITV10□□

Flat bracket

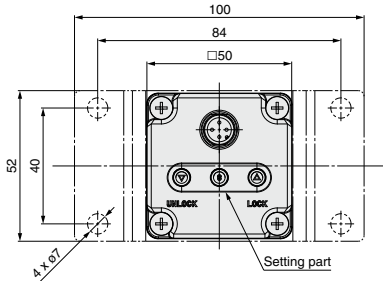

Note) Do not attempt to rotate, as the cable connector does not turn.

Right angle type (4 cores)
Cable connector 3 m

Straight type (4 cores)
Cable connector 3 m

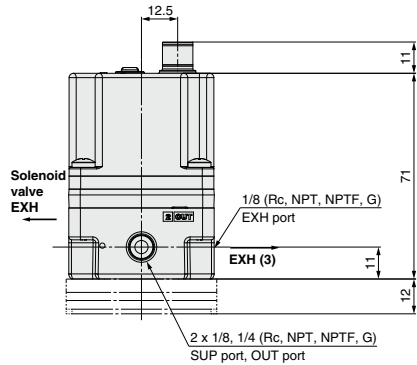
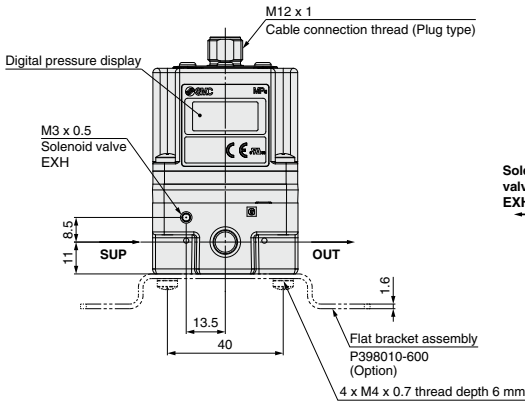
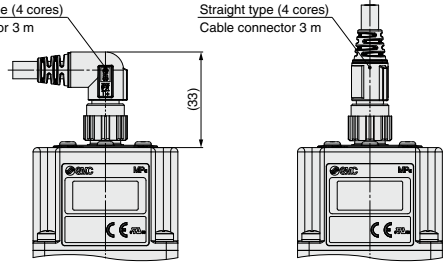

L-bracket

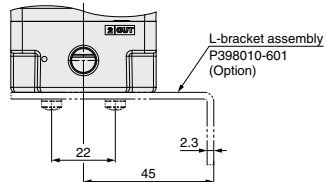
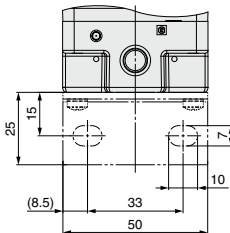

Dimensions (16 points preset input, 10 bit digital input, CC-Link, DeviceNet™, PROFIBUS DP and RS-232C)

16 points preset input

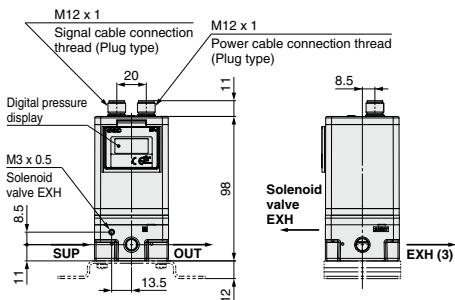

10 bit digital input

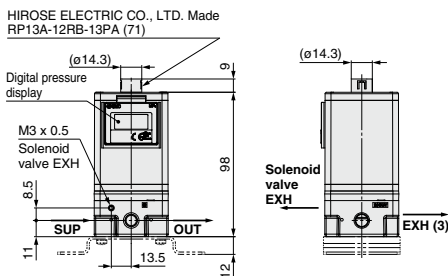

CC-Link/ITV10□0-CC

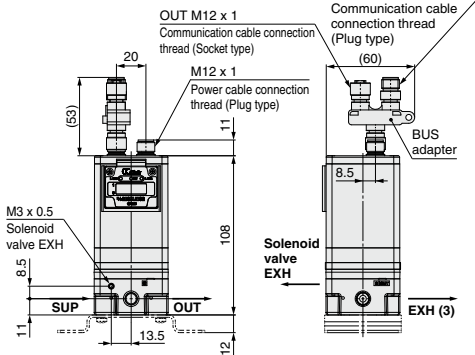

* Dimensions not shown are same as on page 916.

DeviceNet™/ITV10□0-DE

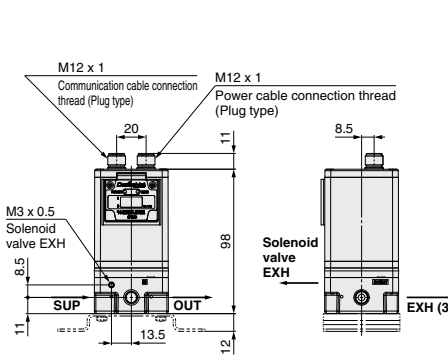

* Dimensions not shown are same as on page 916.

PROFIBUS DP/ITV10□0-PR

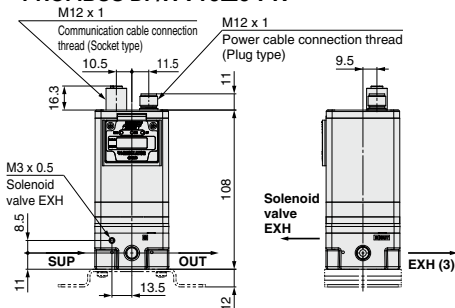

* Dimensions not shown are same as on page 916.

RS-232C/ITV10□0-RC

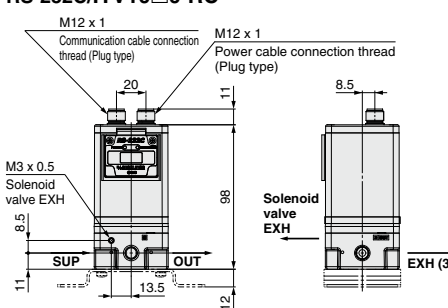

* Dimensions not shown are same as on page 916.

With power cable connector

52
53
* ITV10□0-CC-DE-PR-RC common dimensions

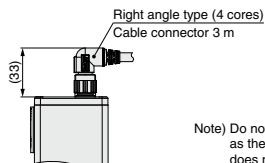
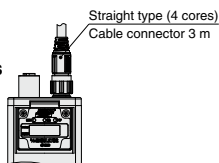

Note) Order communication cable (other than 16 points, RS-232C) separately. (Refer to page 904.)

Note) Do not attempt to rotate, as the cable connector does not turn.

ARJ
AR425 to 935
ARX
AMR
ARM
ARP
IR□-A
IR
IRV
VEV
SRH
SRP
SRF
ITV
IC
ITVH
ITVX
PVQ
VY1
VBA
VBAT
AP100

ITV1000/2000/3000 Series

Dimensions

ITV20□□

Flat bracket

Note) Do not attempt to rotate, as the cable connector does not turn.

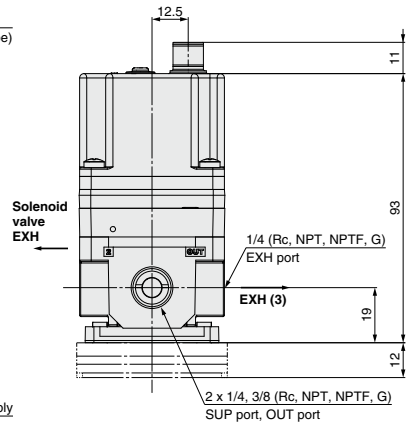
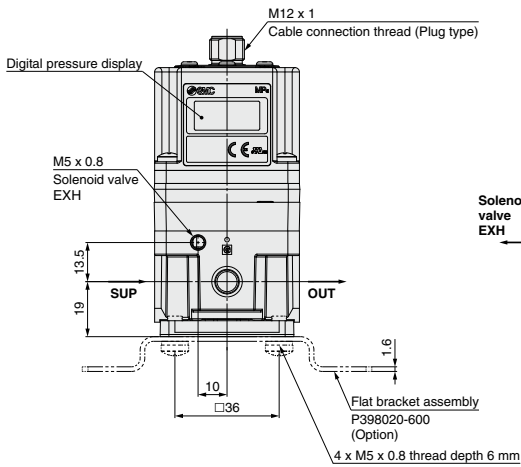
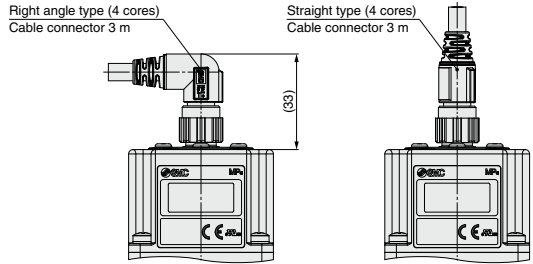
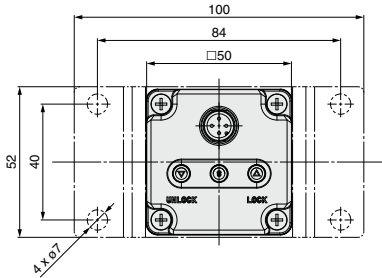

L-bracket

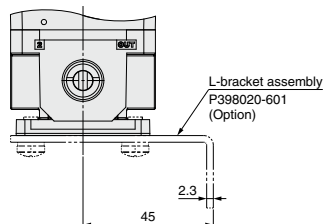
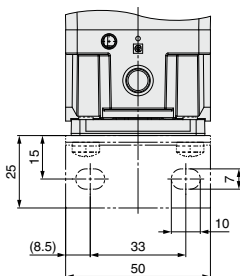

Dimensions (16 points preset input, 10 bit digital input, CC-Link, DeviceNet™, PROFIBUS DP and RS-232C)

16 points preset input

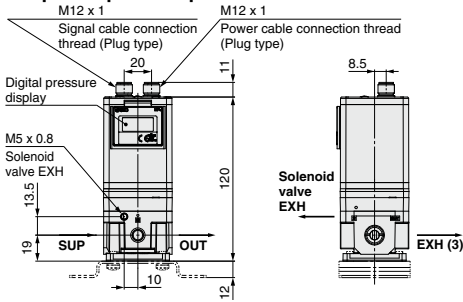

10 bit digital input

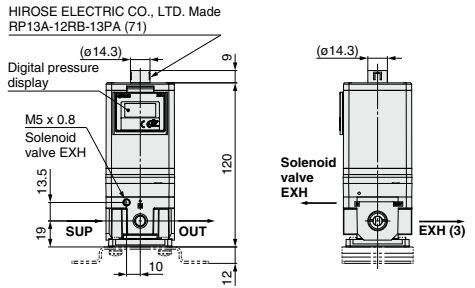

CC-Link/ITV20□0-CC

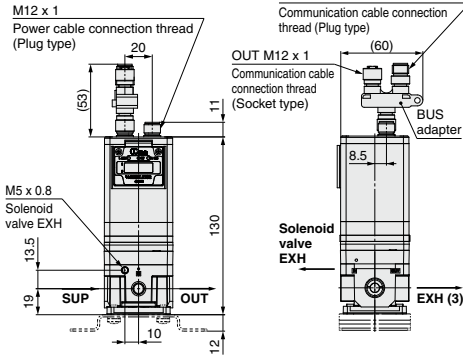

DeviceNet™/ITV20□0-DE

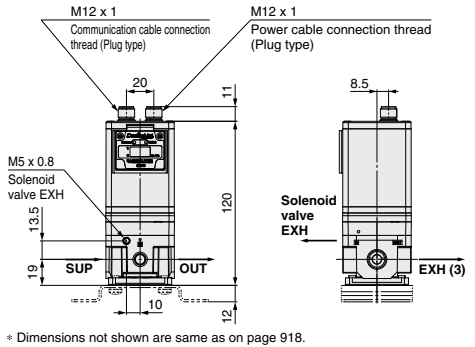

* Dimensions not shown are same as on page 918.

* Dimensions not shown are same as on page 918.

PROFIBUS DP/ITV20□0-PR

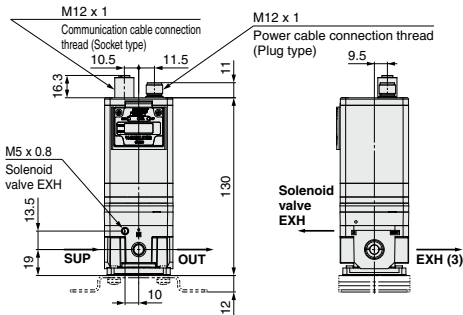

* Dimensions not shown are same as on page 918.

RS-232C/ITV20□0-RC

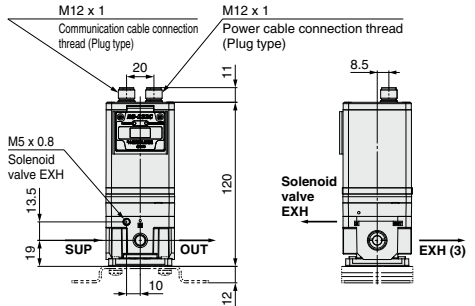

* Dimensions not shown are same as on page 918.

With power cable connector

* ITV20□0-
52
53
CC
DE
PR
RC
common dimensions

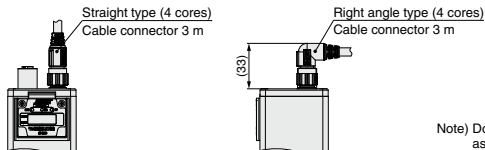

Note) Order communication cable (other than 16 points, RS-232C) separately. (Refer to page 904.)

Note) Do not attempt to rotate, as the cable connector does not turn.

ARJ
AR425 to 935
ARX
AMR
ARM
ARP
IR□-A
IR
IRV
VEV
SRH
SRP
SRF
ITV
IC
ITVH
ITVX
PVQ
VY1
VBA
VBAT
AP100

ITV1000/2000/3000 Series

Dimensions

ITV30□□

Flat bracket

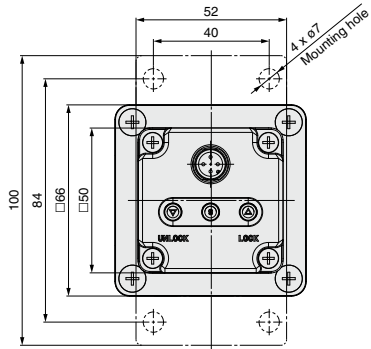

Note) Do not attempt to rotate, as the cable connector does not turn.

Right angle type (4 cores)
Cable connector 3 m

Straight type (4 cores)
Cable connector 3 m

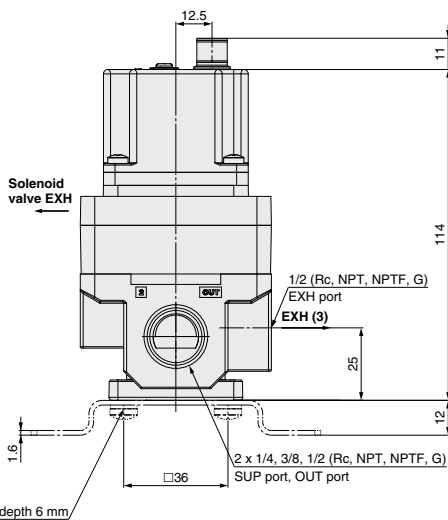
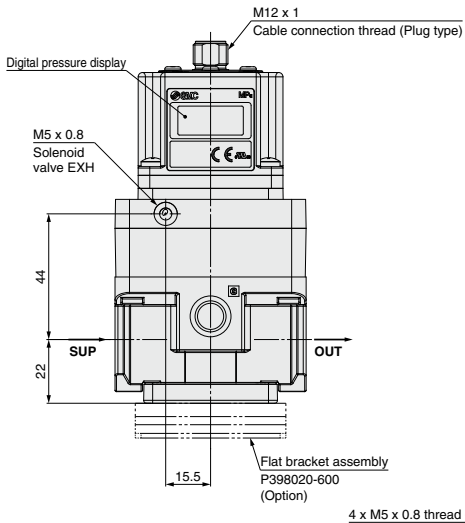
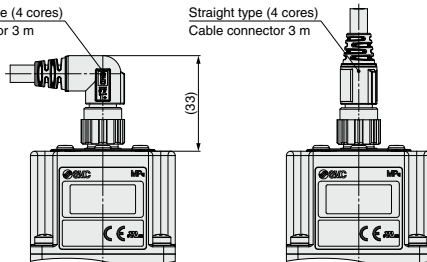

L-bracket

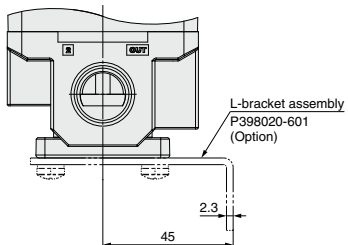
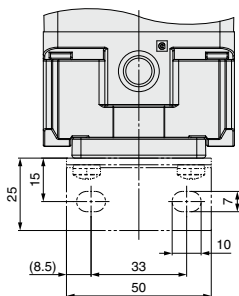

Dimensions (16 points preset input, 10 bit digital input, CC-Link, DeviceNet™, PROFIBUS DP and RS-232C)

16 points preset input

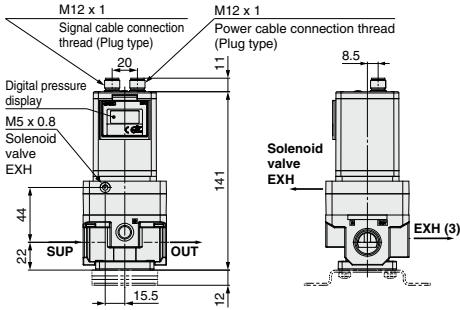

10 bit digital input

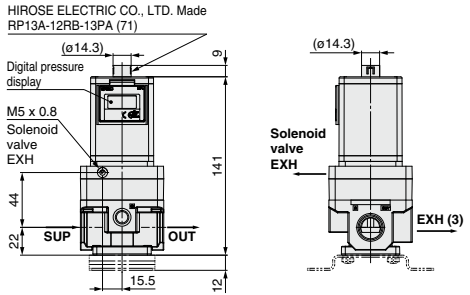

CC-Link/ITV30□-CC

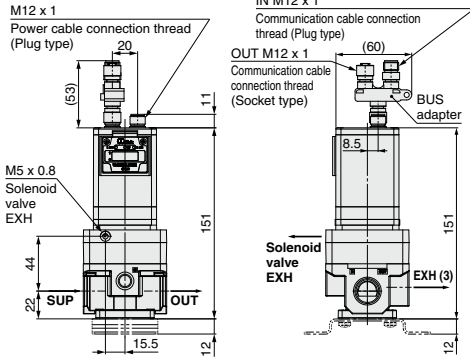

* Dimensions not shown are same as on page 920.

DeviceNet™/ITV30□-DE

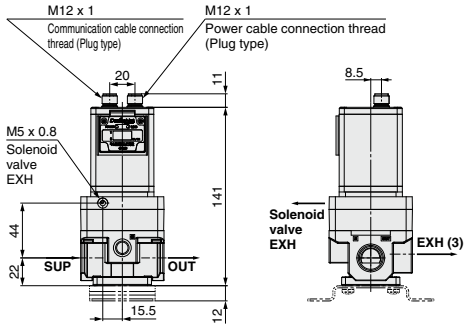

* Dimensions not shown are same as on page 920.

PROFIBUS DP/ITV30□-PR

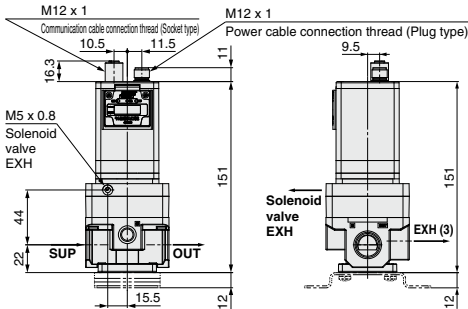

* Dimensions not shown are same as on page 920.

RS-232C/ITV30□-RC

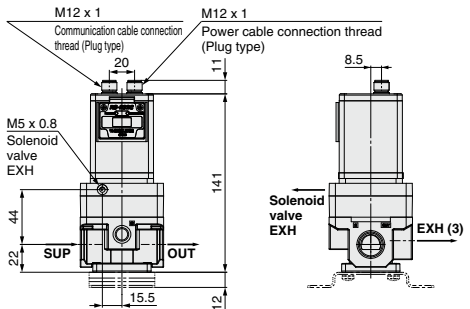

* Dimensions not shown are same as on page 920.

With power cable connector

* **ITV30□-CC**
* **ITV30□-DE**
* **ITV30□-PR**
* **ITV30□-RC**
common dimensions

Note) Order communication cable (other than 16 points, RS-232C) separately. (Refer to page 904.)

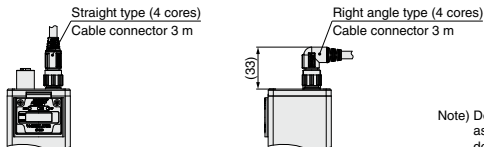

Note) Do not attempt to rotate, as the cable connector does not turn.

ARJ
AR425 to 935
ARX
AMR
ARM
ARP
IR□-A
IR
IRV
VEV
SRH
SRP
SRF
ITV
IC
ITVH
ITVX
PVQ
VY1
VBA
VBAT
AP100

Made to Order Specifications 1

Please contact SMC for detailed dimensions, specifications and lead times.



1 Reverse Type

In compliance with input, inverse proportional pressure is displayed.

ITV10 - - X102

ITV20 - - X102

ITV30 - - X102

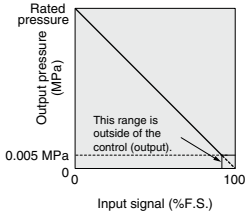

Input/output characteristics chart

- Note 1) in part number is the same model no. for the standard products.
- Note 2) Except for preset input type and digital input type.
- Note 3) For communication models, consult SMC for availability.

3 Set Pressure Range 1 to 100 kPa

ITV10 - - X25

ITV20 - - X25

- Note 1) For preset input type, digital input type and communication models, consult SMC for availability.

2 High Pressure Type (SUP 1.2 MPa, OUT 1.0 MPa)

ITV10 - - X224

ITV20 - - X224

ITV30 - - X224

- Note 1) For preset input type, digital input type and communication models, consult SMC for availability.

Made to Order Specifications 2

Please contact SMC for detailed dimensions, specifications and lead times.



4 High-Speed Response Time Type

Pressure response with no load is approx. 0.1 sec.

Note 1) This is not a guaranteed value as it depends on the operating environment.

Note 2) When the input signal is at 0%, the exhaust solenoid valve is controlled to reduce the outlet pressure to zero. For this reason, a noise may be generated. This noise is normal and does not indicate a fault.

Note 3) When operating for the first time, be sure that the power supply voltage and supply pressure are appropriate in relation to the operating environment and conditions.

Note 4) For this product, by conducting the procedure described below (steps A to D), the parameters compatible with the power supply voltage and supply pressure in use can be obtained.

If the desired output pressure values cannot be reached due to fluctuations in the operating conditions, etc., perform this operation.

A) Change the power supply voltage in use by ± 0.4 VDC or more.

B) After inputting the supply pressure used on the inlet side of the ITV, adjust the input signal as described below.

(0% \rightarrow 100% \rightarrow 0%) (Change it gradually, waiting 10 s or more between each adjustment.)

* Please contact SMC if difficulty inputting signals occurs.

C) Change the power supply voltage according to the operating conditions/requirements, and repeat step B.

D) Input the power supply voltage and a 0% signal, and retain for 6 minutes or more. (Supply pressure is not required.)

When re-obtaining the parameters, we recommend operating with the air sealed in the piping in order to reliably reach the set pressure. In addition, if item A) above cannot be carried out, it is possible to conduct an "Initialize" operation as described in the operation manual in order to reset the parameters of the product to those set at the time of shipment. When conducting an "Initialize" operation, the min. set pressure (F_1) and the max. set pressure (F_2) will be reset.

ITV 2 0 1 0 - 0 1 [] 2 [] S [] - X88

● Model

1	1000 type
2	2000 type

● Pressure range

1	0.1 MPa
3	0.5 MPa
5	0.9 MPa

● Power supply voltage

0	24 VDC
1	12 to 15 VDC

● Input signal

0	Current type 4 to 20 mA DC (Sink type)
1	Current type 0 to 20 mA DC (Sink type)
2	Voltage type 0 to 5 VDC
3	Voltage type 0 to 10 VDC

● Monitor output

1	Analog output 1 to 5 VDC
2	Switch output/NPN output
3	Switch output/PNP output
4	Analog output 4 to 20 mA DC (Sink type)

● Thread type

Nii	Rc
N	NPT
T	NPTF
F	G

● Pressure display unit

Nii	MPa
2*	kgf/cm ²
3	bar
4*	psi
5	kPa

* Under Japan's new Measurement Act, this is only for overseas sales (SI units are to be used inside Japan).

● Cable connector type

S	Straight type 3 m
L	Right angle type 3 m
N	Without cable connector

● Bracket *

Nii	Without bracket
B	Flat bracket
C	L-bracket

* Bracket is included.

● Port size

1	1/8 (1000 type)
2	1/4 (1000, 2000 type)
3	3/8 (2000 type)

ARJ

AR425 to 935

ARX

AMR

ARM

ARP

IR□-A

IR

IRV

VEX

SRH

SRP

SRF

ITV

IC

ITVH

ITVX

PVQ

VY1

VBA
VBAT

AP100

Made to Order Specifications 3

Please contact SMC for detailed dimensions, specifications and lead times.



5 Manifold Specifications (Except ITV3000 series)

2 through 8 station manifold.

How to Order Manifolds

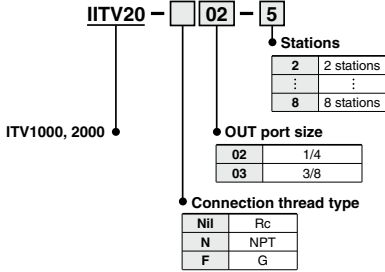

How to Order for Manifold Mounted

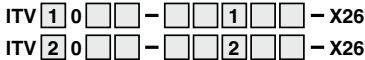

- Note 1) in part number is the same model no. for the standard products.
 Note 2) For communication models, consult SMC for availability.
 Note 3) The thread type is Rc only.
 Note 4) For ITV1000 series, the port size is 1/8 only.
 Note 5) For ITV2000 series, the port size is 1/4 only.
 Note 6) The bracket accessory can not be selected.
 Note 7) Not applicable to ITV3000 series

ITV20-02-31 set (3 station manifold base part no.)
 *ITV1030-311S-X261 set (Electro-pneumatic regulator part no.) ^{Note 2)}
 *P398020-131 set (Blanking plate assembly part no.)
 *ITV2050-212S-X261 set (Electro-pneumatic regulator part no.) ^{Note 2)}

The * is the symbol for mounting. Add the * symbol at the beginning of part numbers for electro-pneumatic regulators, etc. to be mounted on the base.

How to Order Manifold Assemblies

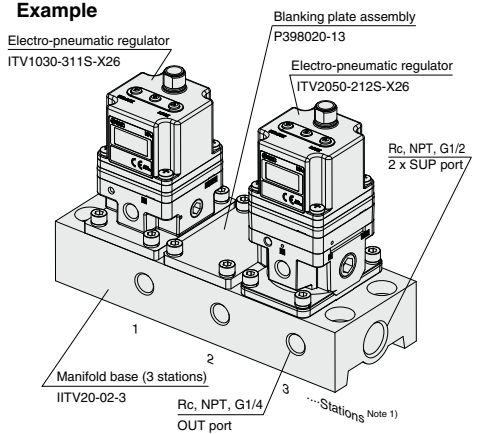

Note) Refer to the table below for possible mixed combination.

Model	ITV101	ITV103	ITV105	ITV201	ITV203	ITV205
ITV101	●	—	—	●	—	—
ITV103	—	●	—	—	●	—
ITV105	—	—	●	—	—	●
ITV201	●	—	—	●	—	—
ITV203	—	●	—	—	●	—
ITV205	—	—	●	—	—	●

- Note 1) Electro-pneumatic regulators are counted starting from station 1 on the left side with the OUT ports in front.
 Note 2) The port size for mounted electro-pneumatic regulators is Rc 1/8 (ITV1000), Rc 1/4 (ITV2000) only.
 Note 3) When there is a large number of stations, use piping with the largest possible inside diameter for the supply side, such as steel piping.
 Note 4) The use of the straight type cable connector is recommended. To mount right angle type, be certain to check that no possible interference occurs.
 Note 5) When mounting a blanking plate and the regulator with different pressure set, please inform SMC of the order of a manifold station beside a purchase order.

Made to Order Specifications 4

Please contact SMC for detailed dimensions, specifications, and lead times.



6 Linearity: ±0.5% F.S. or Less

Application examples: Polishing equipment and peripheral equipment for wafers, LCD glasses, color filters, etc.

ITV 3 0 1 0 - 0 1 [] 2 [] S [] - X410

Model

1	1000 type
2	2000 type
3	3000 type

Pressure range

1	0.1 MPa
3	0.5 MPa
5	0.9 MPa

Power supply voltage

0	24 VDC
1	12 to 15 VDC

Input signal

0	Current type 4 to 20 mA DC (Sink type)
1	Current type 0 to 20 mA DC (Sink type)
2	Voltage type 0 to 5 VDC
3	Voltage type 0 to 10 VDC

Monitor output

1	Analog output 1 to 5 VDC
2	Switch output/NPN output
3	Switch output/PNP output
4	Analog output 4 to 20 mA DC (Sink type)

Thread type

Nil	Rc
N	NPT
T	NPTF
F	G

Bracket *

Nil	Without bracket
B	Flat bracket
C	L-bracket

* Bracket is included.

Port size

1	1/8 (1000 type)
2	1/4 (1000, 2000, 3000 type)
3	3/8 (2000, 3000 type)
4	1/2 (3000 type)

Linearity:
±0.5% F.S. or less

Pressure display unit

Nil	MPa
2 (Note)	kgf/cm ²
3	bar
4 (Note)	psi
5	kPa

Note) Under Japan's new Measurement Act, this is only for overseas sales (SI units are to be used inside Japan).

Cable connector type

S	Straight type 3 m
L	Right angle type 3 m
N	Without cable connector

Rated pressure

The graph shows that the output pressure curve for the -X410 model is significantly more linear (±0.5% F.S.) compared to the Standard model (±1% F.S.).

Specifications

Fluid	Air	
Minimum supply pressure	Set pressure +0.1 MPa	
Maximum supply pressure	1.0 MPa (Pressure range 0.1 MPa type: 0.2 MPa)	
Proof pressure	(Supply side)	1.5 MPa (Pressure range 0.1 MPa type: 0.3 MPa)
	(Output side)	1 MPa (Pressure range 0.1 MPa type: 0.2 MPa)
Set pressure range	1: 0.005 to 0.1 MPa, 3: 0.005 to 0.5 MPa, 5: 0.005 to 0.9 MPa	
Power supply voltage	0: 24 VDC ±10%, 1: 12 to 15 VDC	
	0.12 A or less (24 VDC ±10% type)	
Current consumption	0.18 A or less (12 to 15 VDC type)	
	0: 4 to 20 mA, 1: 0 to 20 mA, 2: 0 to 5 VDC, 3: 0 to 10 VDC	
Input impedance	Voltage type: Approx. 6.5 kΩ, Current type: 250 Ω or less	
Output signal	Analog output: 1 to 5 VDC/4 to 20 mA DC, Switch output (NPN/PNP)	
Linearity	±0.5% F.S. or less	
Hysteresis	0.5% F.S. or less	
Repeatability	±0.5% F.S. or less	
Sensitivity	0.2% F.S. or less	
Temperature characteristics	±0.12% F.S./°C or less	
Output pressure display	Accuracy	±2% F.S. ±1 digit or less
	Minimum unit	MPa: 0.001, kgf/cm ² : 0.01, bar: 0.01, psi: 0.1, kPa: 1
Ambient and fluid temperature	0 to 50°C (No condensation)	
Enclosure	IP65	
Weight	ITV1000: Approx. 250 g, ITV2000: Approx. 350 g, ITV3000: Approx. 645 g (without brackets)	

The above characteristics (specifications) are confined to the static state. When air is consumed on the output side, the pressure may fluctuate.

ARJ
AR425 to 935
ARX
AMR
ARM
ARP
IR□-A
IR
IRV
VEX
SRH
SRP
SRF
ITV
IC
ITVH
ITVX
PVQ
VY1
VBA
VBAT
AP100

Made to Order Specifications 5

Please contact SMC for detailed dimensions, specifications, and lead times.



7 With Alarm Output

Alarm is output if the set pressure is not reached or maintained for 5 seconds or more.

Application examples: Pressure management for thrust control, etc.

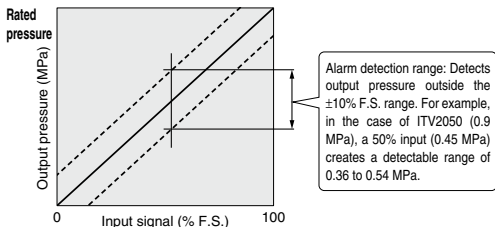
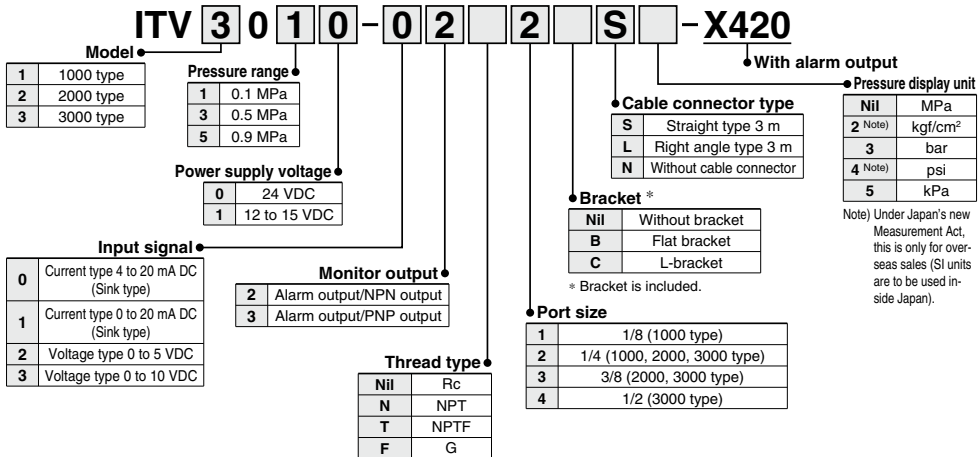

Figure 1. Alarm output range

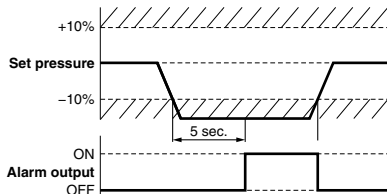

Figure 2. Relationship between output pressure and alarm output

Specifications

Fluid	Air	
Minimum supply pressure	Set pressure +0.1 MPa	
Maximum supply pressure	1.0 MPa (Pressure range 0.1 MPa type: 0.2 MPa)	
Proof pressure	(Supply side)	1.5 MPa (Pressure range 0.1 MPa type: 0.3 MPa)
	(Output side)	1 MPa (Pressure range 0.1 MPa type: 0.2 MPa)
Set pressure range	1: 0.005 to 0.1 MPa, 3: 0.005 to 0.5 MPa, 5: 0.005 to 0.9 MPa	
Power supply voltage	0: 24 VDC ±10%, 1: 12 to 15 VDC	
Current consumption	0.12 A or less (24 VDC ±10% type)	
	0.18 A or less (12 to 15 VDC type)	
Input signal	0: 4 to 20 mA, 1: 0 to 20 mA, 2: 0 to 5 VDC, 3: 0 to 10 VDC	
Input impedance	Voltage type: Approx. 6.5 kΩ, Current type: 250 Ω or less	
Output signal	Alarm output (NPN/PNP)	
Linearity	±1.0% F.S. or less	
Hysteresis	0.5% F.S. or less	
Repeatability	±0.5% F.S. or less	
Sensitivity	0.2% F.S. or less	
Temperature characteristics	±0.12% F.S./°C or less	
	±2% F.S. ±1 digit or less	
Output pressure display	Accuracy	MPa: 0.001, kgf/cm ² : 0.01, bar: 0.01, psi: 0.1, kPa: 1
	Minimum unit	
Ambient and fluid temperature	0 to 50°C (No condensation)	
Enclosure	IP65	
Weight	ITV10□□: Approx. 250 g, ITV20□□: Approx. 350 g, ITV30□□: Approx. 645 g (without brackets)	

The above characteristics (specifications) are confined to the static state. When air is consumed on the output side, the pressure may fluctuate.

ARJ
AR425 to 935
ARX
AMR
ARM
ARP
IR□-A
IR
IRV
VEX
SRH
SRP
SRF
ITV
IC
ITVH
ITVX
PVQ
VY1
VBA VBAT
AP100

Compact Vacuum Regulator

ITV009 Series



How to Order

For single unit and single unit for manifold

ITV00 9 0 - 3 **N**

Pressure range

9	-100 kPa
---	----------

Power supply voltage

0	24 VDC ±10%
1	12 to 15 VDC

Input signal

0	Current type 4 to 20 mA DC (Sink type)
1	Current type 0 to 20 mA DC (Sink type)
2	Voltage type 0 to 5 VDC
3	Voltage type 0 to 10 VDC

Built-in One-touch fittings type

For single unit

Symbol	VAC ¹	OUT ²	ATM ³
Nil	Metric size (Light gray)	ø4	
U	Inch size (Orange)	ø5/32"	

For manifold

Symbol	VAC ¹	OUT ²	ATM ³	
Nil	Metric size (Light gray)	ø6	ø4	ø6
U	Inch size (Orange)	ø1/4"	ø5/32"	ø1/4"

Cable connector (Option)

N	Without cable connector
S	Straight type 3 m
L	Right angle type 2 m

Bracket/Option for single unit only

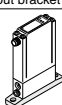
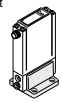
Nil	Without bracket
B	Flat Bracket 
C	L-bracket 

Base type

Nil	For single unit
M	For manifolds

Manifold

IITV00 - 02 - **n**

Stations

02	2 stations
03	3 stations
⋮	⋮
10	10 stations

Option
If a DIN rail longer than the specified stations is required, specify the applicable stations in two digits.
(Maximum 10 stations)
Example) IITV00-05-07

One-touch fitting size for supply/exhaust parts (End plate)

Nil	ø6 (Light gray)
U	ø1/4" (Orange)

Note) A DIN rail with the length specified by the number of stations is attached to the manifold. For dimensions of the DIN rail, refer to the external dimensions.

How to Order Manifold Assembly (Example)

Indicate the part numbers of electro-pneumatic regulators to be mounted below the manifold part number.

Example)

Due to the common supply/exhaust feature, note that different pressure range combinations are not available.

IITV00-03.....1 set (Manifold part no.)

* ITV0090-3MS.....2 sets (Vacuum regulator part no. (1, 2 stations))

* ITV0090-3ML.....1 set (Vacuum regulator part no. (3 stations))

Indicate part numbers in order starting from the first station on the D side.

Note) Combination with having different pressure ranges is not available due to common supply/exhaust features.

The asterisk (*) specifies mounting. Add an asterisk (*) at the beginning of electro-pneumatic regulator part numbers to be mounted.

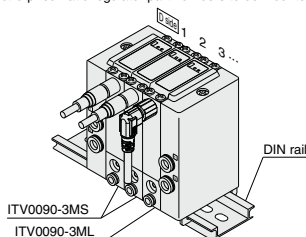

Specifications

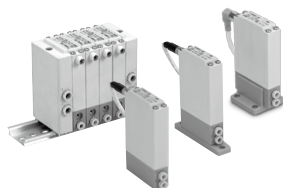

Model		ITV009 	
Minimum supply pressure		Set pressure -1 kPa	
Maximum supply pressure		-101 kPa	
Set pressure range		-1 to -100 kPa	
Power supply	Voltage	24 VDC $\pm 10\%$, 12 to 15 VDC	
	Current consumption	Power supply voltage 24 VDC type: 0.12 A or less Power supply voltage 12 to 15 VDC type: 0.18 A or less	
Input signal	Voltage type	0 to 5 VDC, 0 to 10 VDC	
	Current type	4 to 20 mA DC, 0 to 20 mA DC (Sink type)	
Input impedance	Voltage type	Approx. 10 k Ω	
	Current type	Approx. 250 Ω	
Output signal ^{Note 4)}	Analog output	1 to 5 VDC (Output impedance: Approx. 1 k Ω) Output accuracy: $\pm 6\%$ F.S. or less	
Linearity		$\pm 1\%$ F.S. or less	
Hysteresis		0.5% F.S. or less	
Repeatability		$\pm 0.5\%$ F.S. or less	
Sensitivity		0.2% F.S. or less	
Temperature characteristics		$\pm 0.12\%$ F.S./ $^{\circ}$ C or less	
Operating temperature range		0 to 50 $^{\circ}$ C (No condensation)	
Enclosure		IP65 equivalent *	
Connection type		Built-in One-touch fittings	
Connection size	For single unit	Metric size	[1], [2], [3]: $\phi 4$
		Inch size	[1], [2], [3]: $\phi 5/32$ "
	Manifold	Metric size	[1], [3]: $\phi 6$, [2]: $\phi 4$
		Inch size	[1], [3]: $\phi 1/4$ ", [2]: $\phi 5/32$ "
Weight ^{Note 1)}		100 g or less (without option)	

Note 1) Indicates the weight of a single unit.

For IITV00-n

Total weight (g) Stations (n) x 100 + 130 (Weight of end block A, B assembly) + Weight (g) of DIN rail

Note 2) When there is a downstream flow consumption, pressure may become unstable depending on piping conditions.

Note 3) When the power is turned on, a noise may be generated. This noise is normal and does not indicate a fault.

Note 4) When measuring ITV analog output from 1 to 5 VDC, if the load impedance is less than 100 k Ω , the analog output monitor accuracy of $\pm 6\%$ F.S. or less may not be available. The product with the accuracy of within $\pm 6\%$ is supplied upon your request. Output pressure remains unaffected.

* When using under the conditions equivalent to IP65, connect the fitting or tube to the breathing hole prior to use. (For details, refer to "Specific Product Precautions 1" on page 941.)

Accessories (Option)

Bracket

Flat bracket assembly (including 2 mounting screws)
P39800022

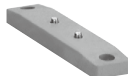

L-bracket assembly (including 2 mounting screws)
P39800023



Tighting torque when assembling is 0.3 N-m.

Cable connector

Straight type
M8-4DSX3MG4



Right angle type
P398000-501-2



ARJ

AR425
to 935

ARX

AMR

ARM

ARP

IR -A

IR

IRV

VEV

SRH

SRP

SRF

ITV

IC

ITVH

ITVX

PVQ

VY1

VBA

VBAT

AP100

Working Principle

When the input signal rises, the vacuum pressure solenoid valve ① turns ON. Due to this, part of the vacuum pressure (VAC.) passes through the vacuum pressure solenoid valve ① and changes to a vacuum pressure. This vacuum pressure feeds back to the control circuit ④ via the pressure sensor ③. Here, the vacuum pressure solenoid valve and the atmospheric pressure solenoid valve work alternately to make continuous pressure corrections until vacuum pressure becomes proportional to the input signal, thus, supplying vacuum pressure that is consistently proportional to the input signal.

Working Principle Diagram

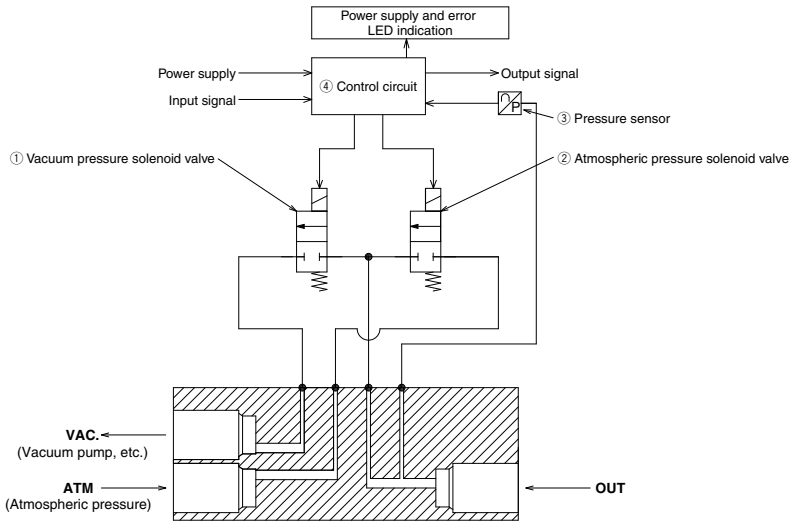

Block Diagram

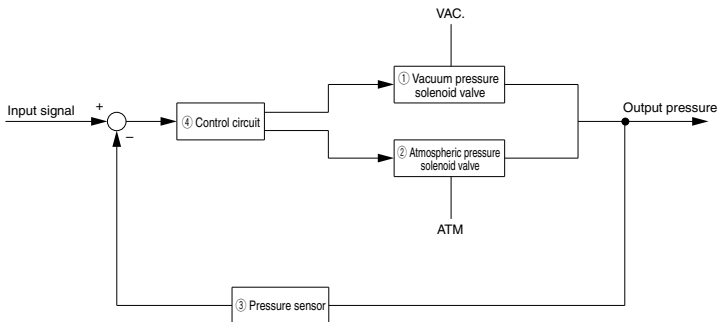

ITV009 **Series**

Linearity, Hysteresis

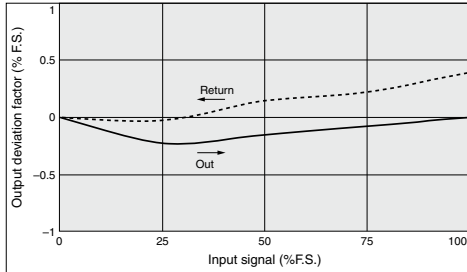

Repeatability

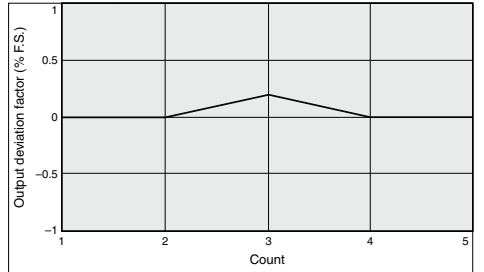

Pressure Characteristics

Set pressure: -10 kPa

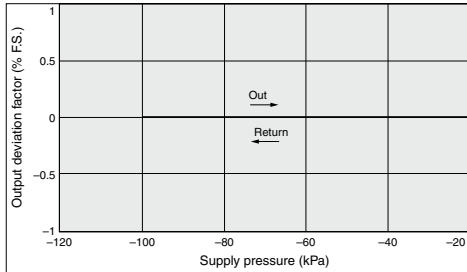

Flow Rate Characteristics

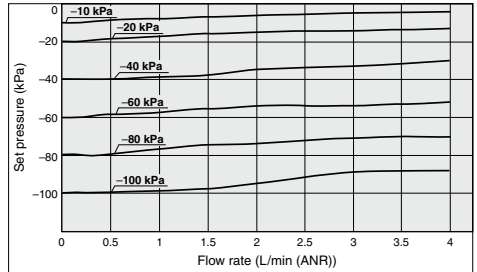

ARJ

AR425
to 935

ARX

AMR

ARM

ARP

IR -A

IR

IRV

VEX

SRH

SRP

SRF

ITV

IC

ITVH

ITVX

PVQ

VY1

VBA
VBAT

AP100

Dimensions

Single unit for manifold

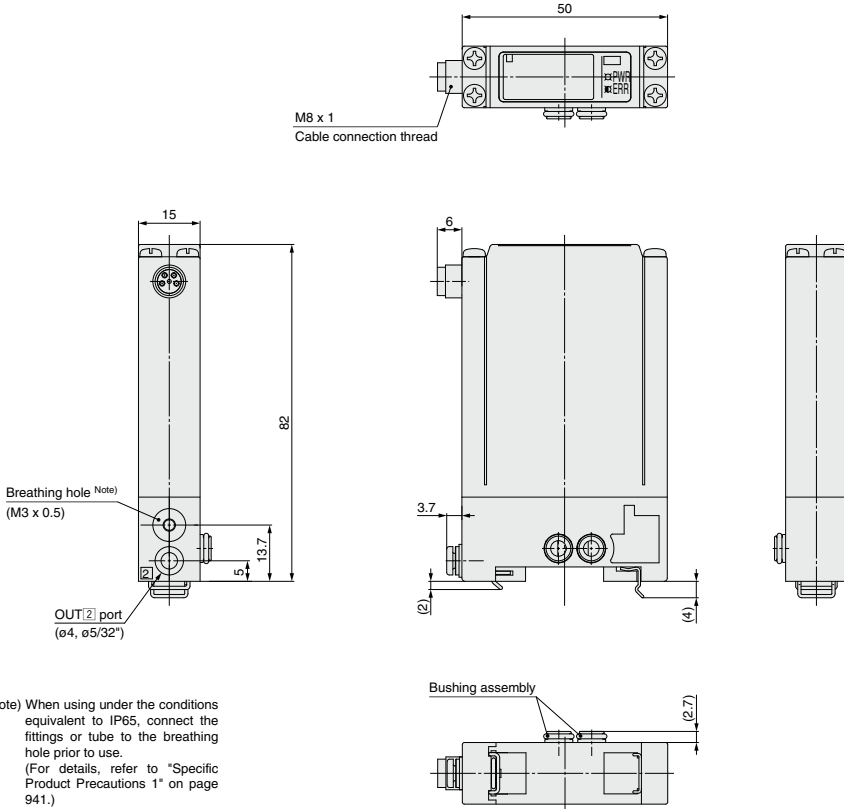

Note) When using under the conditions equivalent to IP65, connect the fittings or tube to the breathing hole prior to use.
(For details, refer to "Specific Product Precautions 1" on page 941.)

Note) For dimensions of the cable connector, refer to single unit on page 932.

ARJ
AR425 to 935
ARX
AMR
ARM
ARP
IR□-A
IR
IRV
VEX
SRH
SRP
SRF
ITV
IC
ITVH
ITVX
PVQ
VY1
VBA
VBAT
AP100

Dimensions

Manifold

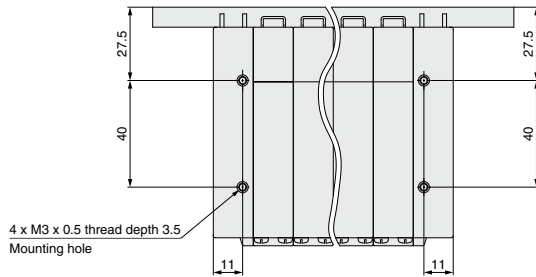

Port Location

No.	[1]	[2]	[3]
ITV009 	VAC	OUT	ATM

Note) Stations are counted starting from the D side.

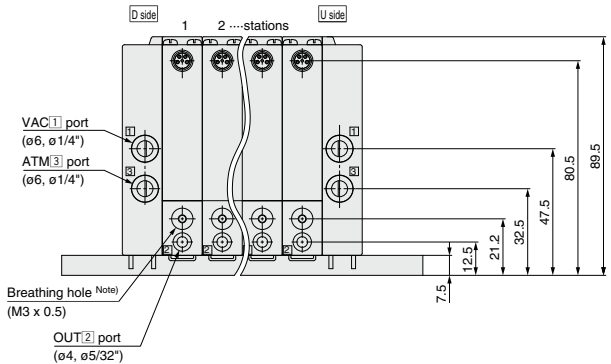
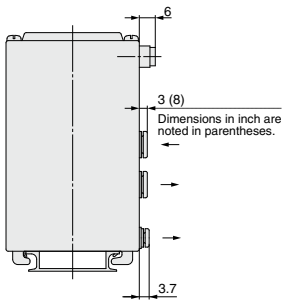
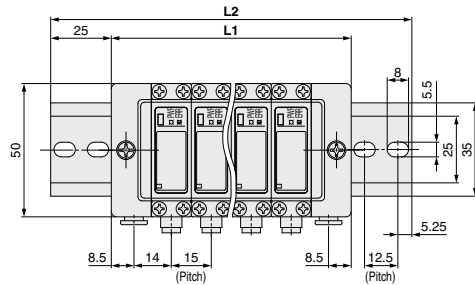

Note) For dimensions of the cable connector, refer to single unit on page 932.

Note) When using under the conditions equivalent to IP65, connect the fittings or tubing to the breathing hole prior to use.
(For details, refer to "Specific Product Precautions 1" on page 941.)

	(mm)									
Manifold stations n	2	3	4	5	6	7	8	9	10	
L1	60	75	90	105	120	135	150	165	180	
L2	110.5	123	148	160.5	173	185.5	198	223	235.5	
Weight of DIN rail (g)	20	22	27	29	31	34	36	41	43	

Electronic Vacuum Regulator ITV2090/2091 Series



How to Order

ITV 209 0 - 0 1 2 S 5

● **Pressure range**

9	-1.3 to -80 kPa
---	-----------------

● **Power supply voltage**

0	24 VDC
1	12 to 15 VDC

Note) Communication models (CC, DE, PR, RC), 16 points preset input and 10 bit digital input are available only for 24 VDC.

● **Pressure display unit**

5	kPa
---	-----

Note) For the communication models, CC, DE, PR and RC, only "Nil" is available as it does not have a pressure display.

● **Cable connector type**

S	Straight type 3 m
L	Right angle type 3 m
N	Without cable connector

Note) Even when a cable connector is selected, communication cable is not included in the communication models, CC, DE and PR. Please order it separately. Refer to the below. For 10 bit digital input, right angle type cannot be selected.

● **Bracket ***

NII	Without bracket
B	Flat bracket
C	L-bracket

* Bracket is included.

● **Port size**

2	1/4
---	-----

● **Thread type**

NII	Rc
N	NPT
T	NPTF
F	G

● **Input signal/ Communication model**

0	Current type 4 to 20 mA DC (Sink type)
1	Current type 0 to 20 mA DC (Sink type)
2	Voltage type 0 to 5 VDC
3	Voltage type 0 to 10 VDC
40	4 points preset input
52	16 points preset input (Switch output/NPN output)
53	16 points preset input (Switch output/PNP output)
60	10 bit digital input
CC	CC-Link
DE	DeviceNet™
PR	PROFIBUS DP
RC	RS-232C communication

● **Monitor output**

1	Analog output 1 to 5 VDC
2	Switch output/NPN output
3	Switch output/PNP output
4	Analog output 4 to 20 mA DC (Sink type)
NII	None

For communications cables, use the parts listed below (refer to M8/M12 connector in Best Pneumatics No.1-1 for details) or order the product certified for the respective protocol (with M12 connector) separately.

Application	Communication cable part number	Note
CC-Link compatibility	PCA-1567720 (Socket type)	Dedicated Bus adapter supplied with the product.
	PCA-1567717 (Plug type)	
DeviceNet™ compatibility	PCA-1557633 (Socket type)	T-branch connector not supplied.
	PCA-1557646 (Plug type)	
PROFIBUS DP compatibility	PCA-1557688 (Socket type)	T-branch connector not supplied.
	PCA-1557691 (Plug type)	

ARJ

AR425 to 935

ARX

AMR

ARM

ARP

IR□-A

IR

IRV

IVX

SRH

SRP

SRF

ITV

IC

ITVH

ITVX

PVQ

VY1

VBA

VBAT

AP100

ITV2090/2091 Series

Stepless control of vacuum pressure proportional to an electrical signal



Standard Specifications

Model	ITV2090	ITV2091
Minimum supply vacuum pressure ^{Note 1)}	Set pressure -13.3 kPa	
Maximum supply vacuum pressure	-101 kPa	
Set pressure range	-1.3 to -80 kPa	
Power supply	Voltage	24 VDC ±10%
	Current consumption	12 to 15 VDC
Input signal ^{Note 7)}	Current type	Power supply voltage 24 VDC type: 0.12 A or less ^{Note 7)} Power supply voltage 12 to 15 VDC type: 0.18 A or less
	Voltage type	4 to 20 mA DC, 0 to 20 mA DC (Sink type)
	Preset input	0 to 5 VDC, 0 to 10 VDC
Input impedance	Digital input	4 points (Negative common), 16 points (No common polarity)
	Current type	10 bit (Parallel)
	Voltage type	250 Ω or less ^{Note 3)}
	Preset input	Approx. 6.5 kΩ
Output signal ^{Note 4)} (Monitor output)	Analog output	Power supply voltage 24 VDC type: Approx. 4.7 kΩ Power supply voltage 12 VDC type: Approx. 2.0 kΩ
	Switch output	Approx. 4.7 kΩ
Linearity	1 to 5 VDC (Output impedance: Approx. 1 kΩ) 4 to 20 mA DC (Sink type) (Output impedance: 250 Ω or less) Output accuracy ± 6% F.S. or less	
Hysteresis	NPN open collector output: Max. 30 V, 80 mA PNP open collector output: Max. 80 mA	
Repeatability	± 1% F.S. or less	
Sensitivity	± 0.5% F.S. or less	
Temperature characteristics	± 0.2% F.S. or less	
Output pressure display	Accuracy	± 2% F.S. ± 1 digit or less
Ambient and fluid temperature	Units	kPa ^{Note 5)} Minimum display: 1
Enclosure	IP65	
Weight ^{Note 7, 8)}	390 g	

Note 1) The minimum supply vacuum pressure should be 13.3 kPa less than the maximum vacuum pressure setting value.
 Note 2) 4 to 20 mA DC is not possible with the 2-wire type. Power supply voltage (24 VDC or 12 to 15 VDC) is required.
 Note 3) Value for the state with no over current circuit included. If an allowance is provided for an over current circuit, the input impedance varies depending on the input power supply. This is 350 Ω or less for an input current of 20 mA DC.

When measuring ITV analog output from 1 to 5 VDC, if the load impedance is less than 100 kΩ, the analog output monitor accuracy of within ±6% (full span) may not be available. The product with the accuracy of within ±6% is supplied upon your request. Output pressure remains unaffected.

Note 4) Either analog output or switch output must be selected. Furthermore, when switch output is selected, either NPN output or PNP output must also be selected. Use caution that the preset input type is not equipped with an output signal function.

Note 5) Please contact SMC regarding indication with other units of pressure.

Note 6) The product characteristics are confined to the static state.

Pressure may fluctuate when air is consumed at the output side.

Note 7) Refer to the table below for communication specifications.

Note 8) Add 50 g for digital input type, 70 g for 16 points preset input type respectively.

Piping/Wiring Diagram

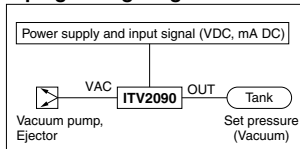

Communication Specifications (CC, DE, PR, RC)

Model	ITV□□0□-CC□□	ITV□□0□-DE□□	ITV□□0□-PR□□	ITV□□0□-RC□□
Protocol	CC-Link	DeviceNet™	PROFIBUS DP	RS-232C
Version ^{Note 1)}	Ver 1.10	Volume1 (Edition3.8), Volume3 (Edition1.5)	DP-V0	—
Communication speed	156 k/625 k 2.5 M/5 M/10 M bps	125 k/250 k/500 k bps	9.6 k/19.2 k/45.45 k 93.75 k/187.5 k/500 k 1.5 M/3 M/6 M/12 M bps	9.6 kbps
Configuration file ^{Note 2)}	—	EDS	GSD	—
I/O occupation area (input/output data)	4 word/4 word, 32 bit/32 bit (per station, remote device station)	16 bit/16 bit	16 bit/16 bit	—
Communication data resolution	12 bit (4096 resolution)	12 bit (4096 resolution)	12 bit (4096 resolution)	10 bit (1024 resolution)
Fail safe	HOLD ^{Note 3)} /CLEAR (Switch setting)	HOLD/CLEAR (Switch setting)	CLEAR	HOLD
Electric insulation ^{Note 4)}	Insulation	Insulation	Insulation	Non-insulation
Terminating resistor	Built into the product (Switch setting)	Not built into the product	Built into the product (Switch setting)	—
Current consumption	0.16 A or less	0.14 A or less	0.16 A or less	0.12 A or less
Weight	ITV2090 470	460	490	460

Note 1) Note that version information is subject to change.

Note 2) Configuration files can be downloaded from the operation manual page on SMC's website: <http://www.smcworld.com>

Note 3) The output HOLD value when a CC-Link communications error occurs can be set based on the bit area data.

Note 4) The insulation between the electrical signal of the communication system and ITV power supply.

Working Principle

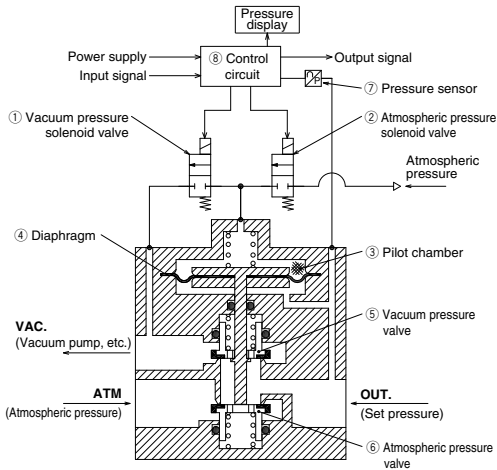

Working Principle

When the input signal increases, the vacuum pressure solenoid valve ① turns ON, and the atmospheric pressure solenoid valve ② turns OFF. Because of this, VAC. and the pilot chamber ③ are connected, the pressure in the pilot chamber ③ becomes negative and acts on the top of the diaphragm ④. As a result, the vacuum pressure valve ⑤ which is linked to the diaphragm ④ opens, VAC. and OUT. are connected, and the set pressure becomes negative. This negative pressure feeds back to the control circuit ⑧ via the pressure sensor ⑦. Then, a correct operation works until a vacuum pressure is obtained which is always proportional to the input signal.

Block Diagram

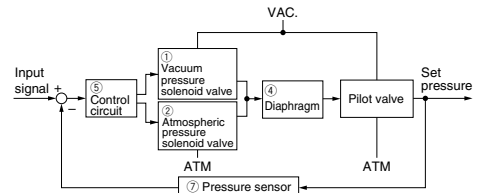

ITV209 Series

Linearity

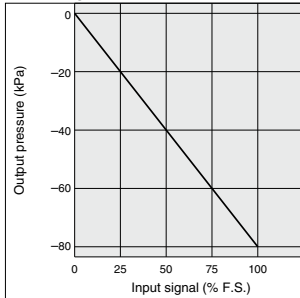

Hysteresis

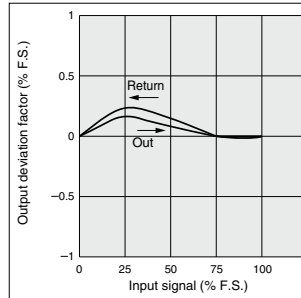

Repeatability

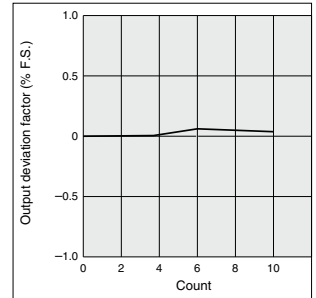

Pressure

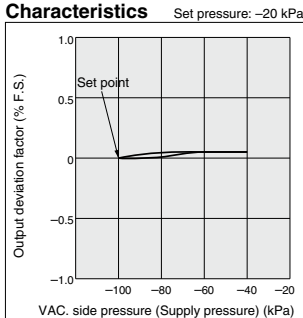

Flow Rate

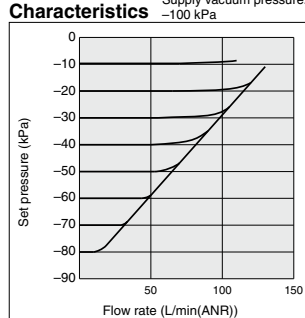

Flow rate characteristics measurement conditions

- Exhaust flow rate of the vacuum pump used for measurement: 500 L/min (ANR)
- Inlet vacuum pressure: -100 kPa (When outlet flow rate is 0 L/min (ANR))
- Maximum flow rate: 132 L/min (ANR) (With inlet vacuum pressure at -39 kPa)

ITV209 Series

Dimensions

ITV209

Flat bracket

Note) Do not attempt to rotate the cable connector, as it does not turn.

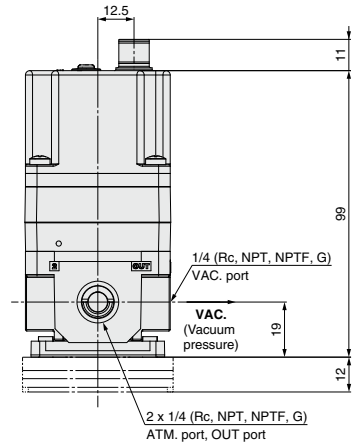
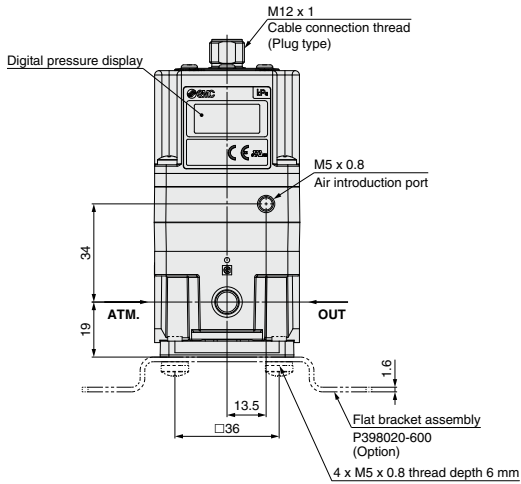
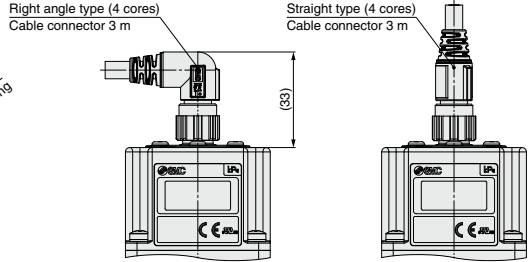
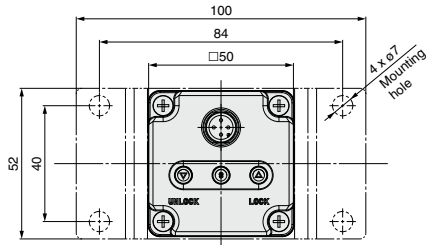

L-bracket

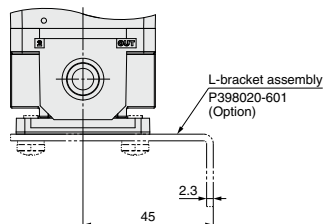
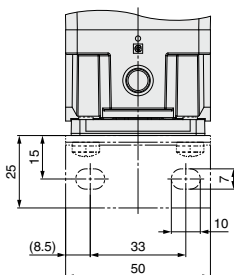

Dimensions (16 points preset input, 10 bit digital input, CC-Link, DeviceNet™, PROFIBUS DP and RS-232C)

16 points preset input

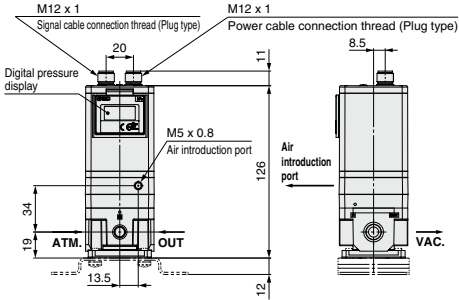

10 bit digital input

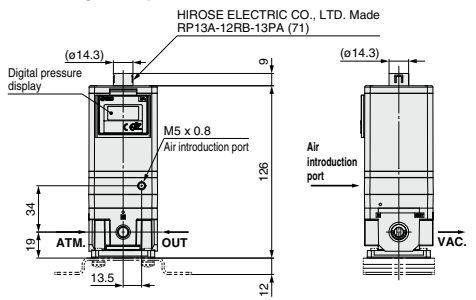

CC-Link/ITV2090-CC

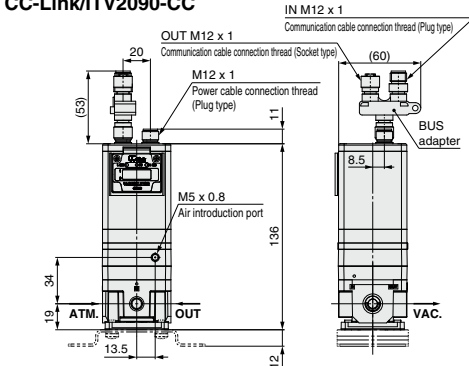

* Dimensions not shown are same as on page 938.

DeviceNet™/ITV2090-DE

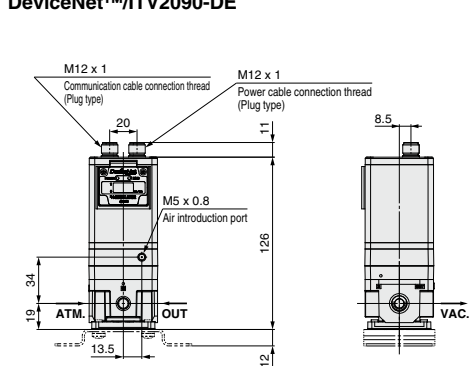

* Dimensions not shown are same as on page 938.

PROFIBUS DP/ITV2090-PR

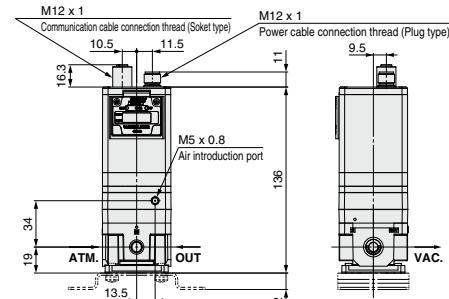

* Dimensions not shown are same as on page 938.

RS-232C/ITV2090-RC

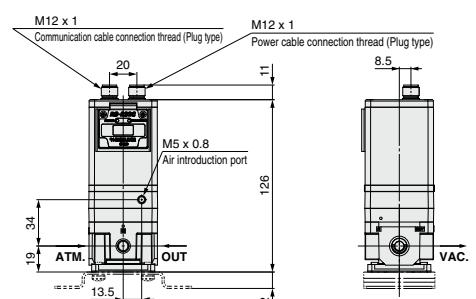

* Dimensions not shown are same as on page 938.

With power cable connector

* **ITV2090-CC** common dimensions
52
53
CC
DE
PR
RC

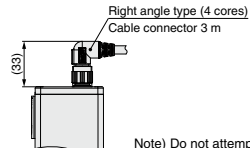
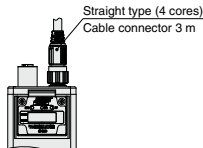

Note) Order communication cable (other than 16 points, RS-232C) separately. (Refer to page 904.)

Note) Do not attempt to rotate the cable connector, as it does not turn.

ARJ
AR425 to 935
ARX
AMR
ARM
ARP
IR□-A
IR
IRV
VEV
SRH
SRP
SRF
ITV
IC
ITVH
ITVX
PVQ
VY1
VBA
VBAT
AP100

Accessories (Option)/Part No.

[Bracket]

Description	Part No.
Flat bracket assembly (including mounting screws)	P398020-600
L-bracket assembly (including mounting screws)	P398020-601

[Cable connector]

Applicable model	Description	Part No.	
Current type Voltage type 4 points preset input	Cable connector (4 cores)	Straight type 3 m	P398020-500-3
		Right angle type 3 m	P398020-501-3
16 points preset input	Power cable (4 cores)	Straight type 3 m	P398020-500-3
		Right angle type 3 m	P398020-501-3
	Signal cable (5 cores)	Straight type 3 m	P398020-502-3
		Right angle type 3 m	P398020-503-3
10 bit digital input	Cable connector (13 cores)	Straight type 3 m	INI-398-0-59
CC-Link PROFIBUS DP DeviceNet™	Power cable (4 cores)	Straight type 3 m	P398020-500-3
		Right angle type 3 m	P398020-501-3
RS-232C	Power cable (4 cores)	Straight type 3 m	P398020-500-3
		Right angle type 3 m	P398020-501-3
	Communication cables connector (5 cores)	Straight type 3 m	P398020-502-3
		Right angle type 3 m	P398020-503-3

Note 1) For the 10-bit digital type, there is no right angle type cable connector.

Note 2) Even when "with cable connector" is selected the communication cable is not included in the communication model (CC, DE, PR). Please order separately.

[Bus adapter]

Applicable model	Description	Part No.
CC-Link	Bus adapter (Bus adapter supplied with the product.)	EX9-ACY00-MJ

Dimensions

Flat bracket

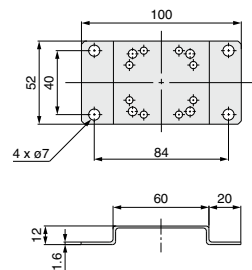

L-bracket

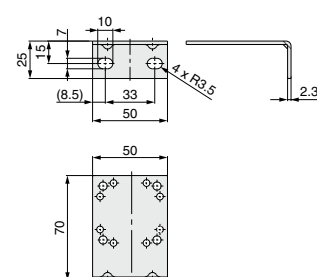

Model	Bracket tightening torque
ITV1000	0.76 ± 0.05 N·m
ITV2000/3000	1.5 ± 0.05 N·m



ITV0000/1000/2000/3000 Series

Specific Product Precautions 1

Be sure to read this before handling the products. Refer to back page 50 for Safety Instructions and pages 387 to 391 for Common Precautions.

ITV0000/009 Series Precautions

Air Supply

⚠ Caution

1. Install an air filter near this product on the supply side. Select a filtration degree of 5 μm or less.
2. Compressed air containing large amounts of drainage can cause malfunction of this product and other pneumatic equipment. As a countermeasure, install an aftercooler, air dryer or Drain Catch, etc.
3. If large amounts of carbon dust are generated by the compressor, it can accumulate inside this product and cause malfunction.

For details on the above compressed air quality, refer to SMC's "Air Preparation Systems".

Wiring

⚠ Caution

Connect the cable to the connector on the body with the wiring arranged as shown below. Proceed carefully, as incorrect wiring can cause damage.

Further, use DC power with sufficient capacity and a low ripple.

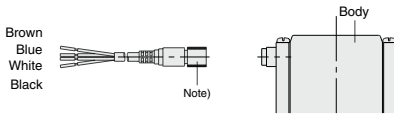

Terminal No.	1	2	3	4
Lead wire color	Brown	White	Blue	Black
Wiring	Power	Signal	COM	Monitor

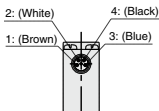

Note) A right angle type cable is also available. The entry direction for the right angle type connector is to downwards (SUP port side).

Never turn the connector as it is not designed to turn. Using force to turn the connector will damage the connector coupling.

Wiring Diagrams

Current signal type

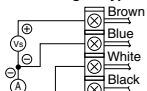

Vs: Power Supply 24 VDC ±10%
12 to 15 VDC
A: Input signals 4 to 20 mA DC
0 to 20 mA DC

Voltage signal type

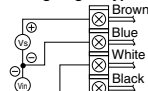

Vs: Power Supply 24 VDC ±10%
12 to 15 VDC
Vin: Input signals 0 to 5 VDC
0 to 10 VDC

Monitor output wiring diagram

Analog output, voltage type

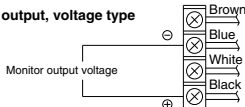

Handling

⚠ Caution

1. Do not use a lubricator on the supply side of this product, as this can cause malfunction. When lubrication of terminal equipment is necessary, connect a lubricator on the output side of this equipment.
2. If electric power is shut off while pressure is being applied, pressure will be retained on the output side. However, this output pressure is held only temporarily and is not guaranteed. If exhausting of this pressure is desired, shut off the power after reducing the set pressure, and discharge the air using a residual pressure exhaust valve, etc.
3. If power to this product is cut off due to a power failure, etc. when it is in a controlled state, output pressure will be retained temporarily. Handle carefully when operating with output pressure released to the atmosphere, as air will continue to flow out.
4. If supply pressure to this product is interrupted while the power is still on, the internal solenoid valve will continue to operate and a humming noise may be generated. Since the life of the product may be shortened, shut off the power supply also when supply pressure is shut off.
5. This product is adjusted for each specification at the time of shipment from the factory. Avoid careless disassembly or removal of parts, as this can lead to malfunction.
6. The optional cable connector is a 4 wire type. When the monitor output (analog output or switch output) is not being used, keep it from touching the other wires as this can cause malfunction.
7. Please note that the right angle cable does not rotate and is limited to only one entry direction.

8. Take the following steps to avoid malfunction due to noise.

- 1) Remove power supply noise during operation by installing a line filter, etc. in the AC power line.
- 2) For avoiding the influence of noise or static electricity, install this product and its wiring as far as possible from strong electric fields such as those of motors and power lines, etc.
- 3) Be sure to implement protective measures against load surge for induction loads (solenoid valves, relays, etc.).

9. The product characteristics are confined to the static state. When air is consumed on the output side, and especially used in the system with large leakage, pressure cannot approach the set pressure and the service life is drastically shortened with a humming noise of the solenoid valve.

10. For details on the handling of this product, refer to the operation manual which is included with the product.

11. In locations where the body is exposed to water, dust, etc., there is a possibility that moisture or dust could enter the body through the breathing hole.

Mount a fitting and tube (M-3AU-3 fitting and TIU01m-mm tube recommended) onto the breathing hole and run the tube to a location not exposed to moisture or dust, etc.

Breathing hole
M3 x 0.5

ARJ

AR425
to 935

ARX

AMR

ARM

ARP

IR□-A

IR

IRV

VEV

SRH

SRP

SRF

ITV

IC

ITVH

ITVX

PVQ

VY1

VBA
VBAT

AP100



ITV0000/1000/2000/3000 Series

Specific Product Precautions 1-1

Be sure to read this before handling the products. Refer to back page 50 for Safety Instructions and pages 387 to 391 for Common Precautions.

ITV0000/009 Series Precautions

Handling

Caution

12. If this product will be used in a sealed environment, such as inside an inspection box, a ventilation fan should be installed to ensure adequate ventilation as this product can generate heat in some operating conditions.
When the power is turned on, a noise may be generated as a means of checking the operating condition of the solenoid valve. This noise is normal and does not indicate a fault.
13. Each product needs to be powered by one power supply unit.
The wiring of this product has the same common between the GND for power and the signals; there is a possibility that a wrong current occurs and prevents a proper operation if one power supply unit controls multiple electro-pneumatic regulators.
14. This product does not have a shut-off valve function. If air pressure is supplied without electric power being applied, output pressure may increase to the pressure equivalent of the supply pressure. Operate the system to shut off the supply pressure when not operating the product.
15. For this product, by conducting the procedure described below (steps A to D), the parameters compatible with the power supply voltage and supply pressure in use can be obtained.
If the desired output pressure values cannot be reached due to fluctuations in the operating conditions, etc., perform this operation.
 - A) Change the power supply voltage in use by ± 0.4 VDC or more.
 - B) After inputting the supply pressure used on the inlet side of the ITV, adjust the input signal as described below.
(0% \rightarrow 100% \rightarrow 0%) (Change it gradually, waiting 10 s or more between each adjustment.)
* Please contact SMC if difficulty inputting signals occurs.
 - C) Change the power supply voltage according to the operating conditions/requirements, and repeat step B.
 - D) Input the power supply voltage and a 0% signal, and retain for 6 minutes or more. (Supply pressure is not required.)

While conducting the procedure stated above, noise may be generated by the solenoid valve. However, this does not affect the obtainment of the parameters. In addition, be sure to conduct the procedure with the air sealed in the piping.

Return of Product

Warning

If the product to be returned is contaminated or is possibly contaminated with substances that are harmful to humans, for safety reasons, please contact SMC beforehand and then employ a specialist cleaning company to decontaminate the product. After the decontamination prescribed above has been carried out, submit a Product Return Request Sheet or the Detoxification/Decontamination Certificate to SMC and await SMC's approval and further instructions before attempting to return the item. Please refer to the International Chemical Safety Cards (ICSC) for a list of harmful substances. If you have any further questions, please don't hesitate to contact your SMC sales representative.

ARJ
AR425 to 935
ARX
AMR
ARM
ARP
IR□-A
IR
IRV
VEV
SRH
SRP
SRF
ITV
IC
ITVH
ITVX
PVQ
VY1
VBA
VBAT
AP100



ITV0000/1000/2000/3000 Series

Specific Product Precautions 2

Be sure to read this before handling the products. Refer to back page 50 for Safety Instructions and pages 387 to 391 for Common Precautions.

ITV1000/2000/3000/209 Series Precautions

Piping

Warning

1. Screw piping together with the recommended proper torque while holding the side that has female threads.

Looseness or faulty sealing will occur if tightening torque is insufficient, while thread damage will result if the torque is excessive. Furthermore, if the side with the female threads is not held while tightening, excessive force will be applied directly to piping brackets, etc. causing damage or other problems.

Connection thread	Recommended proper torque: N · m			
	1/8	1/4	3/8	1/2
Torque	3 to 5	8 to 12	15 to 20	20 to 25

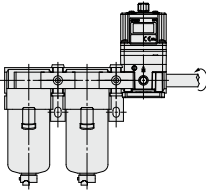

2. Do not allow twisting or bending moment to be applied other than the weight of the equipment itself.

Provide separate support for external piping, as damage may otherwise occur.

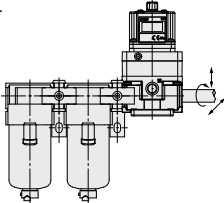

3. Since excessive moment loads and the propagation of vibrations, etc. can easily result from inflexible piping made of materials such as steel, avoid these problems by using flexible tubing for intermediate connections.

Caution

1. Preparation before piping

Before piping is connected, it should be thoroughly blown out with air (flushing) or washed to remove chips, cutting oil and other debris from inside the pipe.

If chips, sealing material or other debris enter into this product, the solenoid valve may buzz, or the outlet pressure may not be output normally.

2. Winding of sealant tape

When screwing together pipes and fittings, etc., be certain that chips from the pipe threads and sealing material do not get inside the piping.

Also, when sealant tape is used, leave 1.5 to 2 thread ridges exposed at the end of the threads.

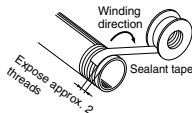

Operating Environment

Warning

1. Do not operate in locations having an atmosphere of corrosive gases, chemicals, sea water, or where there will be contact with the same.

2. Do not operate in locations where vibration or impact occurs.

Caution

1. In locations where the body is exposed to water, steam, dust, etc., there is a possibility that moisture or dust could enter the body through the EXH (solenoid) ports, thereby causing problems.

2. To overcome this, simply install tubing to each port, using the fittings, and extend the tubing so that the other end is at a location where no water splash, etc. occurs. Make sure not to bend, or block the I.D. of the tubing as this will have a detrimental affect on the pressure control.

3. Do not operate in locations where vibration or impact occurs.

4. In locations which receive direct sunlight, provide a protective cover, etc.

5. In locations near heat sources, block off any radiated heat.

6. In locations where there is contact with spatter from water, oil or solder etc., implement suitable protective measures.

Air Supply

Warning

1. Type of fluids

Please consult with SMC when using the product in applications other than compressed air.

2. Do not use compressed air that contains chemicals, synthetic oils including organic solvents, salt or corrosive gases, etc., as it can cause malfunction.

Caution

1. Install an air filter near this product on the supply side. Select a filtration degree of 5 μm or less.

2. Compressed air containing large amounts of drainage can cause malfunction of this product and other pneumatic equipment. As a countermeasure, install an aftercooler, air dryer or Drain Catch, etc.

3. If large amounts of carbon dust are generated by the compressor, it can accumulate inside this product and cause malfunction. For details on the above compressed air quality, refer to SMC's "Air Preparation Systems".



ITV0000/1000/2000/3000 Series

Specific Product Precautions 3

Be sure to read this before handling the products. Refer to back page 50 for Safety Instructions and pages 387 to 391 for Common Precautions.

ITV1000/2000/3000/209 Series Precautions

Handling

Caution

1. Do not use a lubricator on the supply side of this product, as this can cause malfunction. When lubrication of terminal equipment is necessary, connect a lubricator on the output side of this equipment.
2. If electric power is shut off while pressure is being applied, pressure will be retained on the output side. However, this output pressure is held only temporarily and is not guaranteed. If exhausting of this pressure is desired, shut off the power after reducing the set pressure, and discharge the air using a residual pressure exhaust valve, etc.
3. If power to this product is cut off due to a power failure, etc. when it is in a controlled state, output pressure will be retained temporarily. Handle carefully when operating with output pressure released to the atmosphere, as air will continue to flow out.
4. If supply pressure to this product is interrupted while the power is still on, the internal solenoid valve will continue to operate and a humming noise may be generated. Since the life of the product may be shortened, shut off the power supply also when supply pressure is shut off.
5. The setting side pressure cannot be completely released from this product in the range below 0.005 MPa (or -1.3 kPa for Vacuum models). In cases where the pressure needs to be reduced completely to 0 MPa, install a 3 port valve, etc. on the setting side to discharge the residual pressure.
6. This product is adjusted for each specification at the time of shipment from the factory. Avoid careless disassembly or removal of parts, as this can lead to malfunction.
7. The optional cable connector is a 4-wire type. When the monitor output (analog output or switch output) is not being used, keep it from touching the other wires as this can cause malfunction.
8. When connecting the cable to this product, turn the lock ring of the cable. If a portion other than the lock ring of the cable is turned, it may damage the connector on the body. Turn the lock ring by hand without using a tool.
9. The right angle cable does not rotate and is limited to only one entry direction. If the right angle cable is rotated forcibly, the cable may be broken or damaged, or may damage the connector on the body.
10. Take the following steps to avoid malfunction due to noise.
 - 1) Remove power supply noise during operation by installing a line filter, etc. in the AC power line.
 - 2) For avoiding the influence of noise or static electricity, install this product and its wiring as far as possible from strong electric fields such as those of motors and power lines, etc.
 - 3) Be sure to implement protective measures against load surge for induction loads (solenoid valves, relays, etc.).
11. Due to the large volume of the output side, a loud exhaust noise will be produced when being used for the purpose of a relief function. Therefore, install a silencer (SMC AN20 or AN40 series) on the exhaust port (EXH port). The port sizes are Rc 1/8, Rc 1/4 and Rc 1/2.
12. Specifications on pages 905 and 936 is in case of static environment. Pressure may fluctuate when air is consumed at the output side.
13. For details on the handling of this product, refer to the operation manual which is included with the product.
14. This product does not have a shut-off valve function. If air pressure is supplied without electric power being applied, output pressure may increase to the pressure equivalent of the supply pressure. Operate the system to shut off the supply pressure when not operating the product.
15. The solenoid valves built into this product are consumables. Perform periodic maintenance in environments where the solenoid valves are operated at a high frequency. The parts can be replaced with a solenoid valve assembly. Please contact SMC for the part number.

ARP

AR425
to 935

ARX

AMR

ARM

ARP

IR□-A

IR

IRV

VEV

SRH

SRP

SRF

ITV

IC

ITVH

ITVX

PVQ

VY1

VBA

VBAT

AP100



ITV0000/1000/2000/3000 Series Specific Product Precautions 3-1

Be sure to read this before handling the products. Refer to back page 50 for Safety Instructions and pages 387 to 391 for Common Precautions.

ITV1000/2000/3000/209□ Series Precautions

Design and Selection

Caution

1. Use the following UL approved products for DC power supply combinations.

- (1) Limited voltage current circuit in accordance with UL 508.
A circuit in which power is supplied by the secondary coil of a transformer that meets the following conditions.
- Maximum voltage (with no load):
30 Vrms (42.4 V peak) or less
 - Maximum current:
(1) 8 A or less (including when short circuited)
(2) limited by circuit protector (such as fuse) with the following ratings.

No load voltage (V peak)	Max. current rating
0 to 20 [V]	5.0
Over 20 and 30 or less [V]	100
	Peak voltage

- (2) A circuit (class 2 circuit) with maximum 30 Vrms (42.4 V peak) or less, and a power supply consisting of a class 2 power supply unit conforming to UL1310, or a class 2 transformer conforming to UL1585.

2. Operate these products only within the specified voltage.

Using voltages beyond the specified levels could cause faults or malfunctions.

3. Use 0 V as the baseline for the power supplied to the unit for output, control and input.

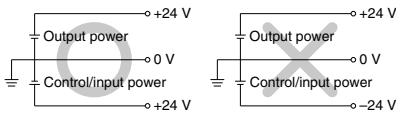

4. Each product needs to be powered by one power supply unit.

The wiring of this product has the same common between the GND for power and the signals; there is a possibility that a wrong current occurs and prevents a proper operation if one power supply unit controls multiple electro-pneumatic regulators.

5. Consult SMC for the usage when the downstream side is released to atmosphere.

This product is a pressure controller. The downstream side being released to atmosphere makes the inlet valve full open, allowing a large amount of atmosphere flow into the body. Consult SMC for the appropriate usage when you use the product under such condition since the product may not meet the specification or the life of the product may be shortened.

ARJ

AR425
to 935

ARX

AMR

ARM

ARP

IR□-A

IR

IRV

VEV

SRH

SRP

SRF

ITV

IC

ITVH

ITVX

PVQ

VY1

VBA

VBAT

AP100



ITV0000/1000/2000/3000 Series Specific Product Precautions 4

Be sure to read this before handling the products. Refer to back page 50 for Safety Instructions and pages 387 to 391 for Common Precautions.

ITV1000/2000/3000/209 Series Precautions

Wiring

Caution

Connect the cable to the connector on the body with the wiring arranged as shown below. Proceed carefully, as incorrect wiring can cause damage. Further, use DC power with sufficient capacity and a low ripple.



Current Signal Type Voltage Signal Type

1	Brown	Power supply
2	White	Input signal
3	Blue	GND (COMMON)
4	Black	Monitor output

Preset Input Type

1	Brown	Power supply
2	White	Input signal 1
3	Blue	GND (COMMON)
4	Black	Input signal 2

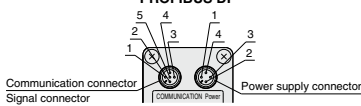
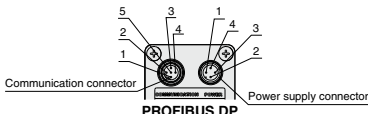
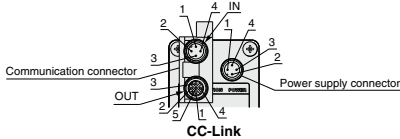

DeviceNet™, RS-232C, 16 points preset

Pin No.	IN/OUT communication connector				Signal connector
	CC-Link	DeviceNet™	PROFIBUS DP	RS-232C	
1	SLD [-]	DRAIN [-]	No connection	No connection	Input signal 1 [Brown]
2	DB [White]	V+ [Red]	RxD/TxD [Green]	TxD [White]	Input signal 2 [White]
3	DG [Yellow]	V- [Black]	No connection	RxD [Blue]	Input signal 3 [Blue]
4	DA [Blue]	CAN_H [White]	RxD/TxD-P [Red]	GND [Black]	Input signal 4 [Black]
5	No connection	CAN_L [Blue]	No connection	No connection	Common [Gray]

Pin No.	Power supply connector				
	CC-Link	DeviceNet™	PROFIBUS DP	RS-232C	16 points preset
1 [Brown]	Vcc	Vcc	Vcc	Vcc	Vcc
2 [White]	FG	Can not connect	FG	No connection	No connection
3 [Blue]	GND	GND	GND	GND	GND
4 [Black]	No connection	Can not connect	No connection	FG	Monitor output

Note 1) The indicated wire colors are when a cable connector made by SMC is used.

Note 2) The cable is also available in a right angle type. (Communication cable: straight type only)

A right angle type connector is attached facing left (towards the SUP port). On communication models, the connector faces backwards (towards the EXH port). Do not attempt to rotate, as the connector does not turn.

Note 3) Perform the wiring so that no electric potential difference occurs between GND of the power supply and GND of the communication section. If any electric potential difference occurs, this may cause the internal parts to burn out.

■ **Trademark Information**
DeviceNet™ is a trademark of ODVA.

Knock-down connectors * Order separately.

Part number	CC-Link compatibility		DeviceNet™ compatibility		PROFIBUS DP compatibility		
	Plug PCA-1557617	Socket PCA-1557620	Plug PCA-1557659	Socket PCA-1557662	Terminal Plug PCA-1557675	Plug PCA-1557701	Socket PCA-1557714

Wiring diagram

Current signal type

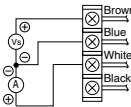

Vs : Power supply 24 VDC
12 to 15 VDC
A : Input signal 4 to 20 mA DC
0 to 20 mA DC

Voltage signal type

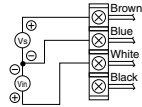

Vs : Power supply 24 VDC
12 to 15 VDC
Vin : Input signal 0 to 5 VDC
0 to 10 VDC

4 points preset input type

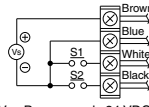

Vs : Power supply 24 VDC
12 to 15 VDC
(Negative common)

16 points preset input type

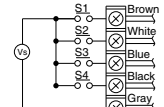

Vs : Power supply 24 VDC (No polarity)

One of the preset pressures P1 through P4 is selected by the ON/OFF combination of S1 and S2.

	S1	S2	S3	S4	P1	P2	P3	P4	P5	P16	P15	P14
ON	OFF	ON	OFF	ON	OFF	ON	OFF	ON	OFF	ON	OFF	ON
OFF	OFF	OFF	OFF	OFF	OFF	OFF	OFF	OFF	OFF	OFF	OFF	OFF
ON	OFF	OFF	OFF	OFF	OFF	OFF	OFF	OFF	OFF	OFF	OFF	OFF
ON	OFF	OFF	OFF	OFF	OFF	OFF	OFF	OFF	OFF	OFF	OFF	OFF
ON	OFF	OFF	OFF	OFF	OFF	OFF	OFF	OFF	OFF	OFF	OFF	OFF

* For safety reasons, it is recommended that one of the preset pressures be set to 0 MPa.

* Preset pressures are set based on the minimum unit for output display.

MPa	kgf/cm ²	bar	psi	kPa
0.001	0.01	0.01	0.1	1

* Note that this is 1 psi for 130 psi types.

10 bit digital input type

Wire color	Signal name
Pink-Black 2	Power supply (24 VDC)
Green-Black 2	Power supply (GND)
Blue	Signal Common (No Polarity)
Blue-Black 2	MSB 10 bit
Gray-Black 1	9 bit
Orange-Black 1	8 bit
Green-Black 1	7 bit
Pink-Black 1	6 bit
Blue-Black 1	5 bit
Gray	4 bit
Orange	3 bit
Green	2 bit
Pink	LSB 1 bit

Note) The wire color is shown for when an option cable is used.



ITV0000/1000/2000/3000 Series Specific Product Precautions 5

Be sure to read this before handling the products. Refer to back page 50 for Safety Instructions and pages 387 to 391 for Common Precautions.

ITV1000/2000/3000/209 Series Precautions

Wiring

Monitor output wiring diagram

Analog output: Voltage type

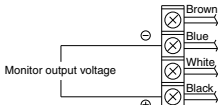

Analog output: Current type (Sink type)

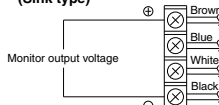

Switch output: NPN type

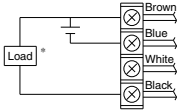

Switch output: PNP type

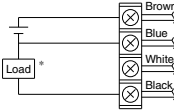

* When 80 mA DC or more is applied, detecting device for overcurrent starts activating and then emits an error signal. (Error number "5")

Set Pressure Range

The set pressure range, by unit of standard measured pressure, is shown in the table below.

Set pressure range, by unit of standard measured pressure

Unit	Set pressure range			
	ITV□01□	ITV□03□	ITV□05□	ITV209□
MPa	0.005 to 0.1	0.005 to 0.5	0.005 to 0.9	—
kgf/cm ²	0.05 to 1	0.05 to 5	0.05 to 9	—
bar	0.05 to 1	0.05 to 5	0.05 to 9	—
psi	0.7 to 15	0.7 to 70	0.7 to 130	—
kPa	5 to 100	5 to 500	5 to 900	-1.3 to -80

CE Marking

• ITV0000 Series

Model	Ferrite core necessity	Recommended power supply cable
ITV0000-□□-Q	Unnecessary	M8-4DSX3MG4 (Straight type) P398000-501-2 (Right angle type)

Note) Recommended power supply cable length is 3 m. (P398000-501-2 is 2 m.) If any other length is desired, please consult with SMC.

• ITV1000/2000/3000 Series

Model	Ferrite core necessity	Recommended power supply cable
ITV□□-□□	—	P398020-500-3 (Straight type) P398020-501-3 (Right angle type)
ITV□□-52□ ITV□□-53□	Power	P398020-500-3 (Straight type) P398020-501-3 (Right angle type)
	Signal	P398020-502-3 (Straight type) P398020-503-3 (Right angle type)
ITV□□-60□	—	INI-398-0-59 (Straight type)
ITV□□-CC□ Note 2) Note 3)	Power	P398020-500-3 (Straight type) P398020-501-3 (Right angle type)
	Communication	PCA-1567720 (Socket type) PCA-1567717 (Plug type)
ITV□□-DE□ Note 2) Note 4)	Power	P398020-500-3 (Straight type) P398020-501-3 (Right angle type)
	Communication	PCA-1557633 (Socket type) PCA-1557646 (Plug type)
ITV□□-PR□ Note 2) Note 4)	Power	P398020-500-3 (Straight type) P398020-501-3 (Right angle type)
	Communication	PCA-1557688 (Socket type) PCA-1557691 (Plug type)
ITV□□-RC□	Power	P398020-500-3 (Straight type) P398020-501-3 (Right angle type)
	Communication	P398020-502-3 (Straight type) P398020-503-3 (Right angle type)

- Note 1) Recommended power supply cable length is 3 m. If any other length is desired, please consult with SMC.
 Note 2) Even when the "with cable connector" type is selected, the communication connector is not included. Refer to the catalog [M8/M12 Connector] CAT.ES100-73 for the details of the communication cable.
 Note 3) For CC-Link compatible products, a dedicated Bus adapter is included with the product.
 Note 4) For DeviceNet™ compatible products, and PROFIBUS DP compatible products, a T-branch connector is not included with the product.

Return of Product

Warning

If the product to be returned is contaminated or is possibly contaminated with substances that are harmful to humans, for safety reasons, please contact SMC beforehand and then employ a specialist cleaning company to decontaminate the product. After the decontamination prescribed above has been carried out, submit a Product Return Request Sheet or the Detoxification/Decontamination Certificate to SMC and await SMC's approval and further instructions before attempting to return the item. Please refer to the International Chemical Safety Cards (ICSC) for a list of harmful substances. If you have any further questions, please don't hesitate to contact your SMC sales representative.



ITV0000/1000/2000/3000 Series

Specific Product Precautions 6

Be sure to read this before handling the products. Refer to back page 50 for Safety Instructions and pages 387 to 391 for Common Precautions.

ITV009□/209□ Series Precautions

Handling

Caution

1. Connect the vacuum pump to the port, which is lab-eled "VAC".
2. Pressure adjustment changes from "atmospheric pressure to vacuum pressure" when the input signal is increased, and from "vacuum pressure to atmospheric pressure" when the input signal is decreased.
3. When adjusting the vacuum pressure, be careful not to block the atmospheric pressure inlet port labeled "ATM".
4. Since this product is designed exclusively for use with negative pressure, be careful not to apply positive pressure in error.
5. In cases where the vacuum pump being used has a relatively small capacity, or the piping has a small inside diameter, etc., large variations in the set pressure (the range of pressure variation when changing from no flow to flow state) may appear. In this situation, the vacuum pump or the piping, etc. should be changed. In cases where it is not practical to change the vacuum pump, install a capacity tank (volume depending on the operating conditions) on the VAC side.
6. The vacuum pressure response time after a change in the input signal is influenced by the internal volume on the setting side (including piping). Since the capacity of the vacuum pump also influences the response time, give careful consideration to these points before operation.
7. If the electric power is shut off when in a control state, the pressure on the setting side will go into a holding condition. However, this setting side pressure will be held only temporarily and is not guaranteed. In addition, when atmospheric pressure is desired, shut off the power after reducing the set pressure, and then introduce atmospheric pressure by using a vacuum release valve, etc.
8. If the power for this product is cut off by a power failure, etc. when it is in a controlled state, the setting side pressure will be held temporarily. Further, if operated without sealing the setting side so that atmospheric air is sucked in, handle with care as air will continue to be sucked in.
9. If the VAC side pressure to this product is interrupted while the power is still on, the internal solenoid valve will continue to operate and may cause a humming noise. Since this may shorten the life of the product, be sure to shut off the power when the VAC side pressure is shut off.
10. The setting side pressure cannot be completely released from this product in the range below -1.3 kPa. In cases where the pressure needs to be reduced completely to 0 kPa, install a 3 port valve, etc. on the setting side to discharge the residual pressure.
11. This product is adjusted for each specification at the factory before shipment. Avoid careless disassembly or removal of parts, as this can cause failure.

Handling

Caution

12. The optional cable connector is a 4-wire type. When the monitor output (analog output, switch output) is not being used, keep it from touching the other wires, as this can cause malfunction.
13. Use caution that the right angle cable does not rotate and is limited to only one entry direction.
14. Take the following steps to avoid malfunction due to noise.
 - 1) Eliminate power supply noise during operation by installing a line filter, etc. in the AC power line.
 - 2) For avoiding the influence of noise or static electricity, install this product and its wiring as far as possible from strong electric fields such as those of motors and power lines, etc.
 - 3) Make sure to take protective measures against load surge for an induction load (solenoid valves, relays, etc.).
15. Refer to the operation manual included with the product for details on its handling.

Return of Product

Warning

If the product to be returned is contaminated or is possibly contaminated with substances that are harmful to humans, for safety reasons, please contact SMC beforehand and then employ a specialist cleaning company to decontaminate the product. After the decontamination prescribed above has been carried out, submit a Product Return Request Sheet or the Detoxification/Decontamination Certificate to SMC and await SMC's approval and further instructions before attempting to return the item. Please refer to the International Chemical Safety Cards (ICSC) for a list of harmful substances. If you have any further questions, please don't hesitate to contact your SMC sales representative.