

# Zero Differential Pressure Type Pilot Operated 2 Port Solenoid Valve For Steam

## VXS Series



Enclosure **IP65**



**Steam**

\* Can be used with heated water.

- VX2
- VXK
- VXD
- VXZ
- VXS**
- VXB
- VXE
- VXP
- VXR
- VXH
- VXF
- VX3
- VXA

Long service life

**3 million cycles**\*1

\*1 Based on SMC's test condition

Improved air filtration

**Double guide rings**

- Stable sliding performance
- Improved scraper performance reduces the entry of foreign objects.

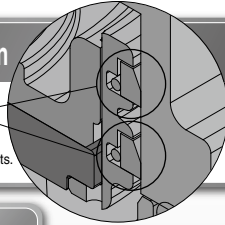

Reduced apparent power

**12 VA**\*2 ← 18 VA

**15 VA**\*3 ← 20 VA

\*2 VX23/24 ← Current model VX22  
\*3 VX25/26 ← Current model VX22

Reduced coil temperature rise

**100°C**\*4 ← 120°C

\*4 VX23 to 26 ← Current model VX22/23

**24 VDC added**



**Electrical entry**

Grommet/DIN terminal  
Conduit terminal/Conduit

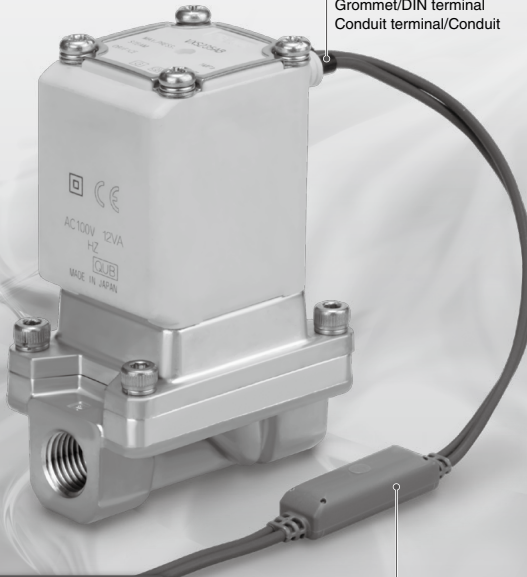

**DIN terminal added**

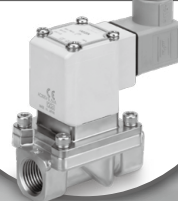

**Body material**

**C37, Stainless steel**



C37 body

Stainless steel body

High sealing performance

Internal leakage (Air)

**1.0 cm<sup>3</sup>/min or less**

Full-wave rectifier standardized

- Improved durability
- Reduced buzz noise
- Low-noise construction

# Zero Differential Pressure Type Pilot Operated 2 Port Solenoid Valve *VXS Series*



Steam

Enclosure  
IP65

Flame resistance  
UL94V-0 conformed

Flame resistant mold coil material

24 VDC,  
DIN terminal  
standardized

Rubber seal  
(special FKM) with high  
sealing performance

Internal leakage (Air)  
**1.0 cm<sup>3</sup>/min or less**

Reliability is improved due to a piston main valve and a rubber seal made of special FKM.

● **Double guide rings**

- Stable sliding performance
- Improved scraper performance reduces the entry of foreign objects.

● **Clearance**

● **Reduced power consumption**

**12 VA**\*1 ← 18 VA

**15 VA**\*2 ← 20 VA

\*1 VXS23/24 ← Current model VXS22

\*2 VXS25/26 ← Current model VXS23

● **Reduced coil temperature rise**

**100°C**\*3 ← 120°C

\*3 VXS23 to 26 ← Current model VXS22/23

● **Improved armature durability**

● **Low-noise construction**

Noise reduction and low impact due to bumper

By providing a bumper and clearance, we reduced the collision sound of the core when ON (when the valve is open).

● **Body material**  
C37, Stainless steel

## Built-in full-wave rectifier type (AC specification)

● **Improved durability**

Service life is extended by the special construction. (compared with current shading coil)

● **Reduced buzz noise**

Rectified to DC by the full-wave rectifier, resulting in a buzz noise reduction.

● **Low-noise construction**

Specially constructed to reduce the metal noise during operation.

Model	Size	Orifice diameter (mm)	Port size	Body material	Fluid
VXS23	10A	10	1/4, 3/8	C37	 Steam
				Stainless steel	
VXS24	15A	15	1/2	C37	
				Stainless steel	
VXS25	20A	20	3/4	C37	
				Stainless steel	
VXS26	25A	25	1	C37	
				Stainless steel	

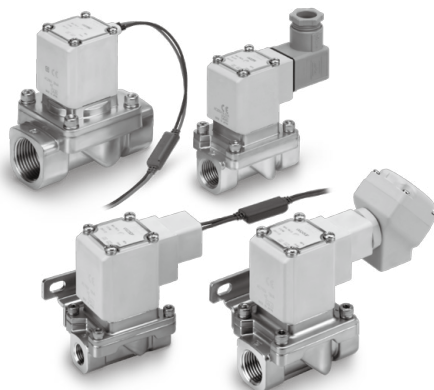

# INDEX

## Zero Differential Pressure Type Pilot Operated 2 Port Solenoid Valve *VXS Series*

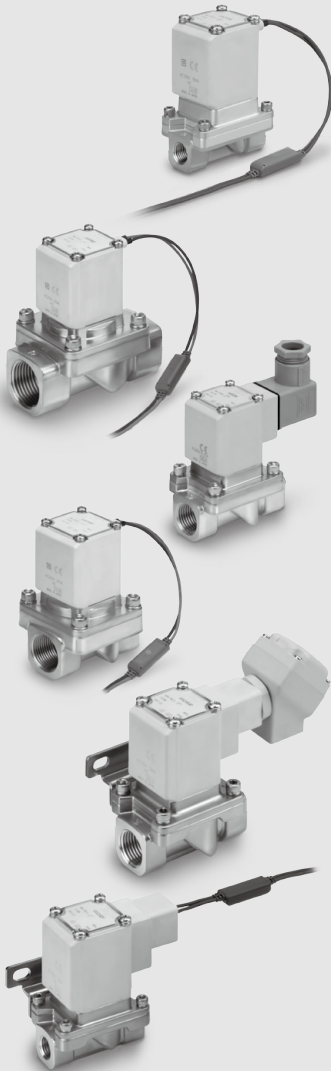

Common Specifications ..... P. 218

Selection Steps..... P. 218



### For Steam

Model/Valve Specifications, Fluid and Ambient Temperature,  
Valve Leakage Rate..... P. 219

How to Order ..... P. 220

Other Special Options ..... P. 221

Construction ..... P. 223

### Dimensions

Body material: C37, Stainless steel ..... P. 224

Replacement Parts..... P. 225

Glossary of Terms ..... P. 226

Solenoid Valve Flow Rate Characteristics ..... P. 227

Flow Rate Characteristics ..... P. 232

Specific Product Precautions ..... P. 233

VX2

VXK

VXD

VXZ

VXS

VXB

VXE

VXP

VXR

VXH

VXF

VX3

VXA

## Standard Specifications

Valve specifications	Valve construction		Zero differential pressure type pilot operated piston type
	Withstand pressure (with water pressure)		2.0 MPa
	Body material		C37 (Brass), Stainless steel
	Seal material		FKM
	Enclosure		Dust-tight, Water-jet-proof type (IP65) <sup>Note 2)</sup>
Coil specifications	Environment		Location without corrosive or explosive gases
	Rated voltage	AC	100 VAC, 200 VAC, 110 VAC, 230 VAC, (220 VAC, 240 VAC, 48 VAC, 24 VAC) <sup>Note 1)</sup>
		DC	24 VDC
	Allowable voltage fluctuation		±10% of rated voltage
	Allowable leakage voltage	AC (Built-in full-wave rectifier type)	5% or less of rated voltage
		DC	2% or less of rated voltage
Coil insulation type		Class H	

Note 1) Voltage in ( ) indicates special voltage. (Refer to page 221.)

Note 2) For enclosure, refer to "Glossary of Terms" on page 226. When using the product in a place which requires water resistance, please contact SMC.

⚠ Be sure to read "Specific Product Precautions" before handling.

⚠ When pressure differential is less than 0.01 MPa, operation may become unstable. Please contact SMC in case of low flow operation. (Refer to page 223.)

## Solenoid Coil Specifications

### Normally Closed (N.C.)

#### DC Specification

Model	Power consumption (W) <sup>Note 1)</sup>	Temperature rise (°C) <sup>Note 2)</sup>
VXS23/24	12	100
VXS25/26	15	100

Note 1) The value at ambient temperature of 20°C and when the rated voltage is applied. (Variation: ±10%)

Note 2) The value at ambient temperature of 20°C and when the rated voltage is applied. The value depends on the ambient environment. This is for reference.

#### AC Specification (Built-in Full-wave Rectifier Type)

Model	Apparent power (VA) <sup>Note 1) 2)</sup>	Temperature rise (°C) <sup>Note 3)</sup>
VXS23/24	12	100
VXS25/26	15	100

Note 1) The value at ambient temperature of 20°C and when the rated voltage is applied. (Variation: ±10%)

Note 2) There is no difference in the frequency and the inrush and energized apparent power, since a rectifying circuit is used in the AC (Built-in full-wave rectifier type).

Note 3) The value at ambient temperature of 20°C and when the rated voltage is applied. The value depends on the ambient environment. This is for reference.

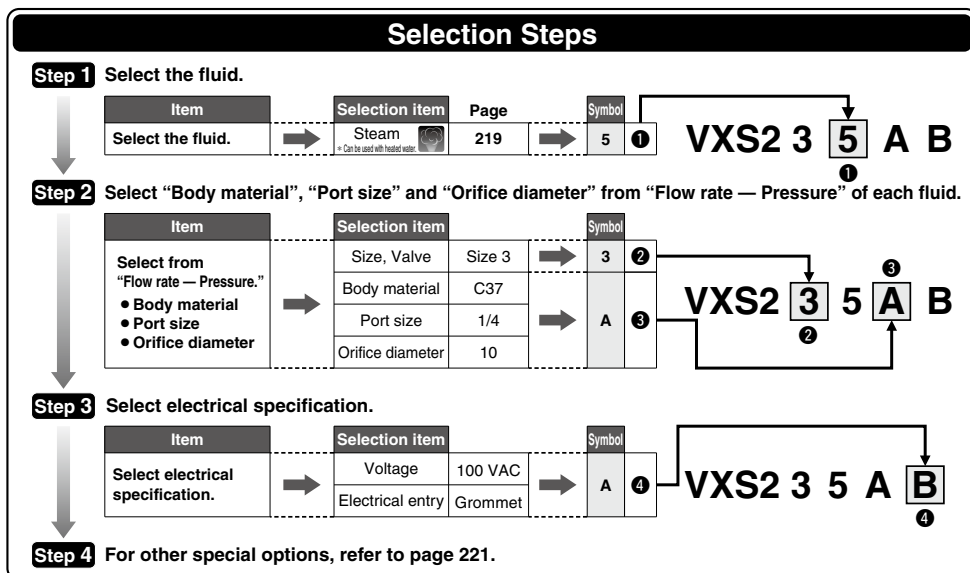



**For Steam**

\* Can be used with heated water.

## Model/Valve Specifications

**N.C.**

**Symbol**

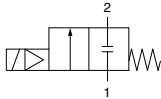

When the valve is closed, flow is blocked from port 1 to port 2. However, if the pressure in port 2 is higher than port 1, the valve will not be able to block the fluid and it will flow from port 2 to port 1.

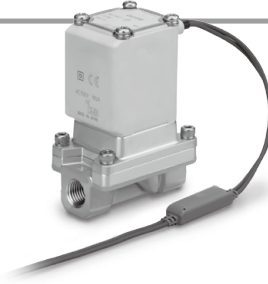

### Normally Closed (N.C.)

Body material	Size	Port size (Nominal diameter)	Orifice diameter (mmø)	Model	Min. operating pressure differential <sup>Note 1)</sup> (MPa)	Max. operating pressure differential <sup>Note 3)</sup> (MPa)		Flow rate characteristics		Max. system pressure <sup>Note 3)</sup> (MPa)	Weight <sup>Note 2)</sup> (g)
						AC	DC	Kv	Cv		
C37, Stainless steel	3	1/4 (8A)	10	VXS235	0	1.0		2.1	2.4	1.0	600
		3/8 (10A)						2.4	2.8		
	4	1/2 (15A)	15	VXS245				4.6	5.3		720
	5	3/4 (20A)	20	VXS255				7.9	9.2		1100
	6	1 (25A)	25	VXS265				10.4	12.0		1300

Note 1) The operation of the valve may be unstable due to the capacity of the pressure supply source such as pumps and boilers or the pressure loss by the orifice of piping. Please contact SMC to check if the required valve size can be used in the application. Please contact SMC for the compatibility of the circuit flow and valve size. (Refer to page 223.)  
Note 2) Weight of grommet type. Add 10 g for conduit, 30 g for DIN terminal, and 60 g for conduit terminal type respectively.  
Note 3) Refer to "Glossary of Terms" on page 226 for details on the maximum operating pressure differential and the maximum system pressure.

## Fluid and Ambient Temperature

Fluid	Temperature (°C)	Ambient temperature (°C)
Steam	183 or less	-20 to 60
Heated water	99 or less	

Note) With no freezing

## Valve Leakage Rate

### Internal Leakage

Fluid	Seal material	Leakage rate <sup>Note 1) 2)</sup>
Steam	FKM	1 cm <sup>3</sup> /min or less <sup>Note 3)</sup>
Heated water		0.1 cm <sup>3</sup> /min or less

Note 1) Leakage is the value at ambient temperature 20°C.

Note 2) Leakage is the value when the pressure differential ranges from 0.02 MPa to the maximum operating pressure differential.

Note 3) With air

### External Leakage

Fluid	Seal material	Leakage rate <sup>Note 1)</sup>
Steam	FKM	1 cm <sup>3</sup> /min or less
Heated water		0.1 cm <sup>3</sup> /min or less

Note 1) Leakage is the value at ambient temperature 20°C.

VX2  
VXX  
VXD  
VXZ  
VXS  
VXB  
VXE  
VXP  
VXR  
VXH  
VXF  
VX3  
VXA

## How to Order



VXS2 **3** **5** **A** **B**

Fluid  
5 For Steam

• **Size/Valve type**

Symbol	Size	Valve type
3	10A	N.C.
4	15A	N.C.
5	20A	N.C.
6	25A	N.C.

• **Body material/Port size/Orifice diameter**

Symbol	Body material	Port size	Orifice diameter
A	C37	1/4	10
B		3/8	
C		1/4	
D	3/8		
F	C37	1/2	15
G	Stainless steel		
H	C37	3/4	20
J	Stainless steel		
K	C37	1	25
L	Stainless steel		

### Common Specifications

Seal material	FKM
Coil insulation type	Class H
Thread type	Rc

### • Voltage/Electrical entry

Symbol	Voltage	Electrical entry
A	24 VDC	Grommet
B	100 VAC	Grommet (With surge voltage suppressor)
C	110 VAC	
D	200 VAC	
E	230 VAC	
G	24 VDC	DIN terminal (With surge voltage suppressor) (Note)
H	100 VAC	
J	110 VAC	
K	200 VAC	
L	230 VAC	Conduit terminal (With surge voltage suppressor)
N	100 VAC	
P	110 VAC	
Q	200 VAC	
R	230 VAC	Conduit (With surge voltage suppressor)
T	100 VAC	
U	110 VAC	
V	200 VAC	
W	230 VAC	Other voltages
Z		

Note) For the class H type DIN terminal, use it in combination with the connector provided.

### For other special options, refer to page 221.

Special voltage	24 VAC
	48 VAC
	220 VAC
	240 VAC
DIN terminal with light	
Conduit terminal with light	
Oil-free	
G thread	
NPT thread	
With bracket	
Special electrical entry direction	

# VXS Series

## Other Special Options

### Electrical options (Special voltage, With light)

VXS2 **3** **5** **A** **Z** **1A**

Enter standard product number.

Electrical option

Special voltage/Electrical entry/Electrical option

Specification	Symbol	Voltage	Electrical entry
Special voltage	1A	48 VAC	Grommet (With surge voltage suppressor)
	1B	220 VAC	
	1C	240 VAC	
	1U	24 VAC	DIN terminal (With surge voltage suppressor)
	1F	48 VAC	
	1G	220 VAC	
	1H	240 VAC	Conduit terminal (With surge voltage suppressor)
	1V	24 VAC	
	1K	48 VAC	
	1L	220 VAC	Conduit (With surge voltage suppressor)
	1M	240 VAC	
	1W	24 VAC	
1P	48 VAC		
1Q	220 VAC		
1R	240 VAC		
1Y	24 VAC		

With light	2A	24 VDC	DIN terminal (With surge voltage suppressor)
	2B	100 VAC	
	2C	110 VAC	
	2D	200 VAC	
	2E	230 VAC	
	2F	48 VAC	
	2G	220 VAC	Conduit terminal (With surge voltage suppressor)
	2H	240 VAC	
	2V	24 VAC	
	2L	100 VAC	
	2M	110 VAC	
	2N	200 VAC	
	2P	230 VAC	
	2Q	48 VAC	
	2R	220 VAC	
	2S	240 VAC	
	2W	24 VAC	

### Other options (Oil-free, Port thread)

VXS2 **3** **5** **A** **A** **Z**

Enter standard product number.

Other option

Oil-free/Port thread

Symbol	Oil-free	Port thread
Nil	—	Rc
A	—	G*
B	—	NPT
D	○	G*
E	○	NPT
Z	○	Rc

\* For connection, prepare a fitting compliant with ISO 16030 and JIS B 8674.

VX2

VXK

VXD

VXZ

VXS

VXB

VXE

VXP

VXR

VXH

VXF

VX3

VXA

\* Enter symbols in the order below when ordering a combination of electrical option, other option, etc.

Example) VXS2 **3** **5** **A** **Z** **1A** **Z** **XB** **A**

Electrical option

Special electrical entry direction

Other option

With bracket

## Installation options (Mounting option/Special electrical entry direction)

The following shows combinations that can be selected using installation options.

**Combinations**

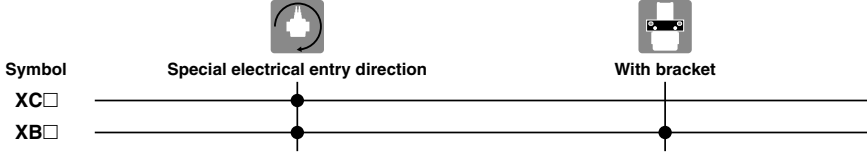

### Special Electrical Entry Direction

VXS2 □ □ □ □ XC A

Enter standard product number.

Symbol	Rotation angle
A	90° 
B	180° 
C	270° 

\*1 Available for the VXS23 to 26.  
\*2 Bracket is packed in the same container as the main body.

### With Bracket/ Special Electrical Entry Direction

VXS2 □ □ □ □ XB A

Enter standard product number.

Symbol	Rotation angle
Nil	Standard 
A	90° 
B	180° 
C	270° 

\*1 Available for the VXS23 to 26.  
\*2 Bracket is packed in the same container as the main body.

\* Enter symbols in the order below when ordering a combination of electrical option, other option, etc.

Example) VXS2 3 5 A Z 1A Z XB A

Electrical option

Other option

Special electrical entry direction

With bracket

### How to mount a bracket

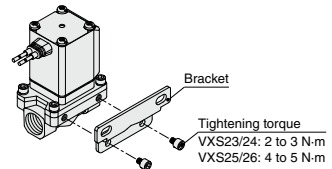



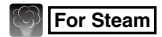

## Construction/Normally Closed (N.C.)

Body material: C37, Stainless steel

### Component Parts

No.	Description	Material
1	Solenoid coil	Cu + Fe + Resin
2	Coil cover	Stainless steel
3	Tube assembly	Stainless steel
4	Return spring	Stainless steel
5	Armature/Piston assembly	Stainless steel, FKM
6	Stopper	FKM
7	Bonnet	C37, Stainless steel
8	Body	C37, Stainless steel
9	O-ring	FKM

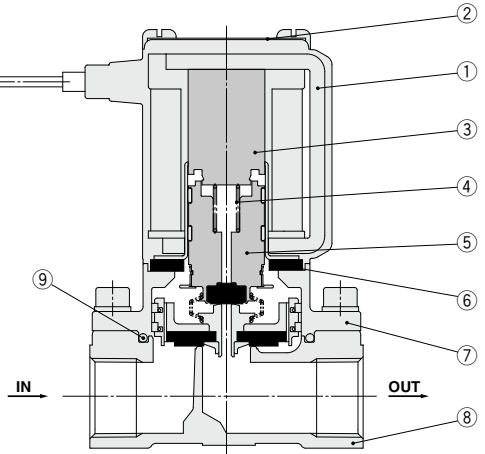

VX2  
VXK  
VXD  
VXZ  
VXS  
VXB  
VXE  
VXP  
VXR  
VXH  
VXF  
VX3  
VXA

## Working Principle

### De-energized

The fluid enters from the IN goes through the supply orifice to fill the pressure action chamber. Main valve is closed by the pressure in the pressure action chamber and the reaction force of the return spring.

### Energized (Pilot valve open)

When the coil is energized, the armature is attracted causing the pilot orifice to opening. The fluid filling the pressure action chamber flows to the OUT side through the pilot orifice.

### Energized (Main valve open)

The pressure in the pressure action chamber decreases by discharging fluid through the pilot orifice. Because the force which pushes down the valve is reduced by the discharge of the fluid, the force that pushes up the main valve overcomes the push down force and opens the main valve. The main valve opens by the lift spring reaction force even if pressure on the IN side is 0 MPa or very low pressure.

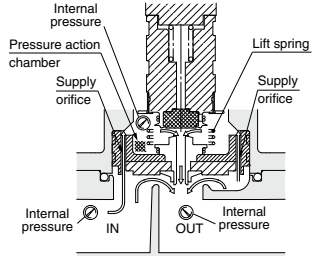
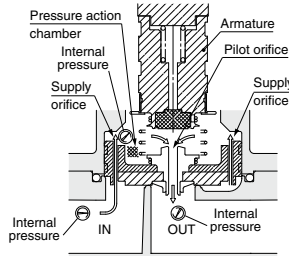
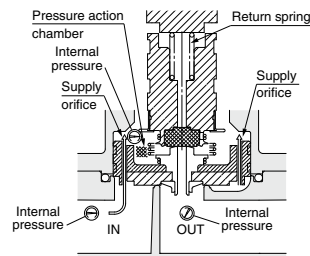

## Warning

Unstable flow may occur with the product under the following conditions: • low flow from the pump or boiler, etc. • use of several elbows or tees in the circuit, or • thin nozzles installed at the end of the piping etc. This can cause valve opening/closing failure, or oscillation, and cause a valve malfunction. If products are used with vacuum, then the vacuum level can be unstable due to these conditions. Please contact SMC to check if the valve can be used in the application by providing the relevant fluid circuit.

# VXS Series

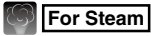

## Dimensions/Body Material: C37, Stainless Steel

### Grommet

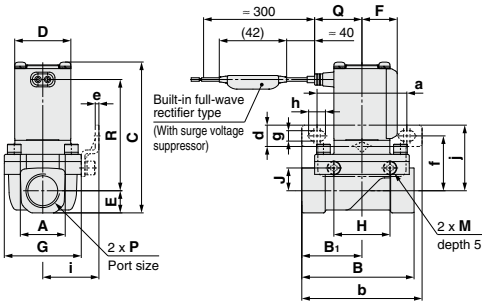

### Conduit terminal

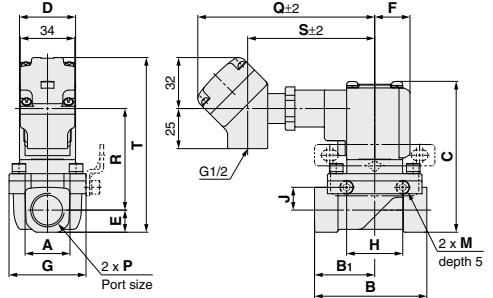

### Conduit

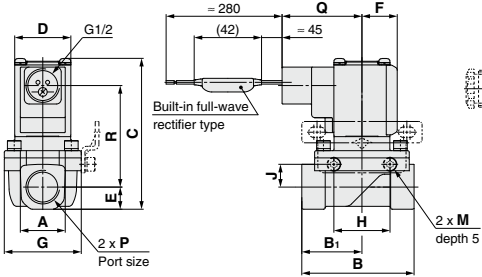

### DIN terminal

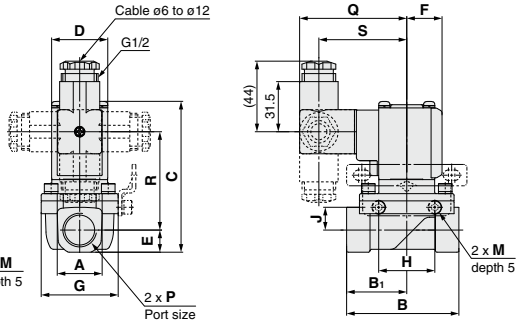

### Bracket mounting hole

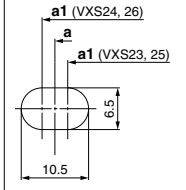

### Dimensions

(mm)

Model	Port size P	A	B	B <sub>1</sub>	C	D	E	F	G	H	J	M	Bracket mounting								
													a	b	d	e	f	g	h	i	j
VXS23	1/4, 3/8	21	57	28.5	87.5	35	10.5	22	40	35	10	M5	56	75	13.5	2.3	30	6.5	10.5	31	37
VXS24	1/2	28	70	37.5	94	35	14	22	48	35	14	M5	56	75		2.3	34	6.5	10.5	35	41
VXS25	3/4	33.5	71	38.5	105.5	40	17	24.5	62	33	15.2	M6	70.5	92		2.3	39	6.5	10.5	43	46
VXS26	1	42	95	49.5	111.5	40	20	24.5	66	37	17.2	M6	70.5	92		2.3	41	6.5	10.5	45	48

Model	Port size P	Electrical entry										
		Grommet		DIN terminal		Conduit terminal			Conduit			
		Q	R	Q	R	S	Q	R	S	T	Q	R
VXS23	1/4, 3/8	29.5	66	67	58	55	110.5	60	79.5	102.5	50	60
VXS24	1/2	29.5	69.5	67	61.5	55	110.5	63.5	79.5	109	50	63.5
VXS25	3/4	32	78	69.5	70	57.5	113	72	82	120.5	52.5	72
VXS26	1	32	81	69.5	72.5	57.5	113	74.5	82	126.5	52.5	74.5

## Replacement Parts

### • DIN Connector Part No.

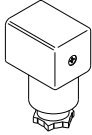

#### <Coil Insulation Type/Class H>

Electrical option	Rated voltage	Connector part no.
None	24 VDC	<b>GDM2A-G-S5</b>
	100 VAC	<b>GDM2A-R</b>
	110 VAC	
	200 VAC	
	220 VAC	
	230 VAC	
	240 VAC	
	24 VAC	
	48 VAC	
With light	24 VDC	<b>GDM2A-G-Z5</b>
	100 VAC	<b>GDM2A-R-L1</b>
	110 VAC	<b>GDM2A-R-L1</b>
	200 VAC	<b>GDM2A-R-L2</b>
	220 VAC	<b>GDM2A-R-L2</b>
	230 VAC	<b>GDM2A-R-L2</b>
	240 VAC	<b>GDM2A-R-L2</b>
	24 VAC	<b>GDM2A-R-L5</b>
	48 VAC	<b>GDM2A-R-L5</b>

### • Gasket Part No. for DIN Connector

**VCW20-1-29-1-F**

### • Bracket Assembly Part No.

**VXZ 3 0S-14A-1**

3	VXS2 $\frac{3}{5}$
5	VXS2 $\frac{5}{5}$

\* 2 mounting screws are shipped together with the bracket assembly.

VX2

VXK

VXD

VXZ

**VXS**

VXB

VXE

VXP

VXR

VXH

VXF

VX3

VXA

# Glossary of Terms

## Pressure Terminology

### 1. Maximum operating pressure differential

The maximum pressure differential (the difference between the inlet and outlet pressure) which is allowed for operation. When the outlet pressure is 0 MPa, this becomes the maximum operating pressure.

### 2. Minimum operating pressure differential

The minimum pressure differential (the difference between the inlet pressure and outlet pressure) required to keep the main valve fully open.

### 3. Maximum system pressure

The maximum pressure that can be applied inside the pipelines (line pressure).

[The pressure differential of the solenoid valve portion must be less than the maximum operating pressure differential.]

### 4. Withstand pressure

The pressure in which the valve must be withstood without a drop in performance after holding for one minute under prescribed pressure (static pressure) and returning to the operating pressure range. [value under the prescribed conditions]

## Electrical Terminology

### 1. Apparent power (VA)

Volt-ampere is the product of voltage (V) and current (A). Power consumption (W): For AC,  $W = V \cdot A \cdot \cos\theta$ . For DC,  $W = V \cdot A$ .

Note)  $\cos\theta$  shows power factor.  $\cos\theta = 0.9$

### 2. Surge voltage

A high voltage which is momentarily generated by shutting off the power in the shut-off area.

### 3. Degree of protection

A degree defined in the "JIS C 0920: Waterproof test of electric machinery/appliance and the degree of protection against the intrusion of solid foreign objects."

Verify the degree of protection for each product.

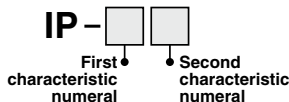

#### ● First Characteristics:

##### Degrees of protection against solid foreign objects

0	Non-protected
1	Protected against solid foreign objects of 50 mmφ and greater
2	Protected against solid foreign objects of 12 mmφ and greater
3	Protected against solid foreign objects of 2.5 mmφ and greater
4	Protected against solid foreign objects of 1.0 mmφ and greater
5	Dust-protected
6	Dust-tight

## Electrical Terminology

#### ● Second Characteristics:

##### Degrees of protection against water

0	Non-protected	—
1	Protected against vertically falling water drops	Dripproof type 1
2	Protected against vertically falling water drops when enclosure tilted up to 15°	Dripproof type 2
3	Protected against rainfall when enclosure tilted up to 60°	Rainproof type
4	Protected against splashing water	Splashproof type
5	Protected against water jets	Water-jet-proof type
6	Protected against powerful water jets	Powerful water-jet-proof type
7	Protected against the effects of temporary immersion in water	Immersible type
8	Protected against the effects of continuous immersion in water	Submersible type

#### Example) IP65: Dust-tight, Water-jet-proof type

"Water-jet-proof type" means that no water intrudes inside an equipment that could hinder from operating normally by means of applying water for 3 minutes in the prescribed manner. Take appropriate protection measures, since a device is not usable in an environment where a droplet of water is splashed constantly.

## Others

### 1. Material

FKM: Fluororubber

### 2. Oil-free treatment

The degreasing and washing of wetted parts

### 3. Symbol

When the valve is closed, flow is blocked from port 1 to port 2. However, if the pressure in port 2 is higher than port 1, the valve will not be able to block the fluid and it will flow from port 2 to port 1.

## Solenoid Valve Flow Rate Characteristics (How to indicate flow rate characteristics)

### 1. Indication of flow rate characteristics

The flow rate characteristics in equipment such as a solenoid valve, etc. are indicated in their specifications as shown in Table (1).

Table (1) Indication of Flow Rate Characteristics

Corresponding equipment	Indication by international standard	Other indications	Conformed standard
Pneumatic equipment	<i>C, b</i>	—	ISO 6358: 1989 JIS B 8390: 2000
	—	<i>S</i>	JIS B 8390: 2000 Equipment: JIS B 8379, 8381-1, 8381-2
	—	<i>Cv</i>	ANSI/(NFPA)T3.21.3 R1-2008
Process fluid control equipment	<i>Kv</i>	—	IEC60534-1: 2005 IEC60534-2-3: 1997 JIS B 2005-1: 2012
	—	<i>Cv</i>	JIS B 2005-2-3: 2004 Equipment: JIS B 8471, 8472, 8473

### 2. Pneumatic equipment

#### 2.1 Indication according to the international standards

(1) Conformed standard

**ISO 6358: 1989** : Pneumatic fluid power—Components using compressible fluids—  
Determination of flow rate characteristics

**JIS B 8390: 2000** : Pneumatic fluid power—Components using compressible fluids—  
How to test flow rate characteristics

(2) Definition of flow rate characteristics

The flow rate characteristics are indicated as a result of a comparison between sonic conductance **C** and critical pressure ratio **b**.

Sonic conductance **C** : Value which divides the passing mass flow rate of an equipment in a choked flow condition by the product of the upstream absolute pressure and the density in a standard condition.

Critical pressure ratio **b** : Pressure ratio (downstream pressure/upstream pressure) which will turn to a choked flow when the value is smaller than this ratio.

Choked flow : The flow in which the upstream pressure is higher than the downstream pressure and where sonic speed in a certain part of an equipment is reached.

Gaseous mass flow rate is in proportion to the upstream pressure and not dependent on the downstream pressure.

Subsonic flow : Flow greater than the critical pressure ratio

Standard condition : Air in a temperature state of 20°C, absolute pressure 0.1 MPa (= 100 kPa = 1 bar), relative humidity 65%.

It is stipulated by adding the “(ANR)” after the unit depicting air volume.

(standard reference atmosphere)

Conformed standard: ISO 8778: 1990 Pneumatic fluid power—Standard reference atmosphere, JIS B 8393: 2000: Pneumatic fluid power—Standard reference atmosphere

(3) Formula for flow rate

It is described by the practical units as following.

When

$$\frac{P_2 + 0.1}{P_1 + 0.1} \leq b, \text{ choked flow}$$

$$Q = 600 \times C (P_1 + 0.1) \sqrt{\frac{293}{273 + T}} \dots\dots\dots(1)$$

When

$$\frac{P_2 + 0.1}{P_1 + 0.1} > b, \text{ subsonic flow}$$

$$Q = 600 \times C (P_1 + 0.1) \sqrt{1 - \left[ \frac{P_2 + 0.1}{P_1 + 0.1} - b \right]^2} \sqrt{\frac{293}{273 + T}} \dots\dots\dots(2)$$

- VX2
- VXK
- VXD
- VXZ
- VXS**
- VXB
- VXE
- VXP
- VXR
- VXH
- VXF
- VX3
- VXA

**Q** : Air flow rate [L/min (ANR)]

**C** : Sonic conductance [ $\text{dm}^3/(\text{s}\cdot\text{bar})$ ],  $\text{dm}^3$  (Cubic decimeter) of SI = L (liter).

**b** : Critical pressure ratio [—]

**P<sub>1</sub>** : Upstream pressure [MPa]

**P<sub>2</sub>** : Downstream pressure [MPa]

**T** : Temperature [°C]

Note) Formula of subsonic flow is the elliptic analogous curve.

Flow rate characteristics are shown in Graph (1) For details, please use the calculation software available from SMC website.

Example)

Obtain the air flow rate for **P<sub>1</sub>** = 0.4 [MPa], **P<sub>2</sub>** = 0.3 [MPa], **T** = 20 [°C] when a solenoid valve is performed in **C** = 2 [ $\text{dm}^3/(\text{s}\cdot\text{bar})$ ] and **b** = 0.3.

According to formula 1, the maximum flow rate =  $600 \times 2 \times (0.4 + 0.1) \times \sqrt{\frac{293}{273 + 20}} = 600$  [L/min (ANR)]

$$\text{Pressure ratio} = \frac{0.3 + 0.1}{0.4 + 0.1} = 0.8$$

Based on Graph (1), it is going to be 0.7 if it is read by the pressure ratio as 0.8 and the flow ratio to be **b** = 0.3. Hence, flow rate = Max. flow x flow ratio =  $600 \times 0.7 = 420$  [L/min (ANR)]

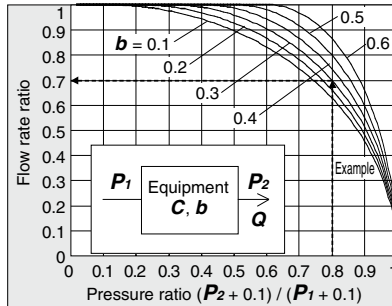

**Graph (1) Flow rate characteristics**

#### (4) Test method

Attach a test equipment with the test circuit shown in Fig. (1) while maintaining the upstream pressure to a certain level which does not go below 0.3 MPa. Next, measure the maximum flow to be saturated in the first place, then measure this flow rate at 80%, 60%, 40%, 20% and the upstream and downstream pressure. And then, obtain the sonic conductance **C** from this maximum flow rate. In addition, calculate **b** using each data of others and the subsonic flow formula, and then obtain the critical pressure ratio **b** from that average.

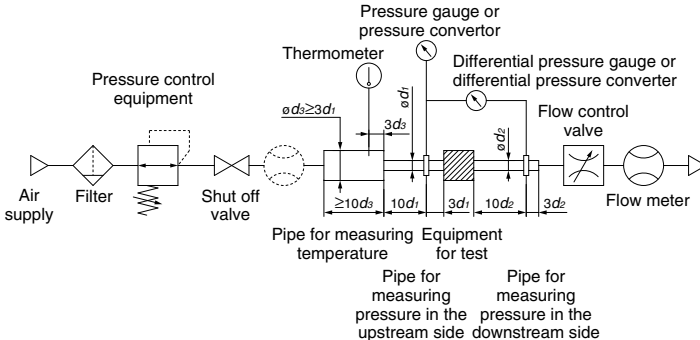

**Fig. (1) Test circuit based on ISO 6358: 1989, JIS B 8390: 2000**

**2.2 Effective area S**

(1) Conformed standard

**JIS B 8390: 2000: Pneumatic fluid power—Components using compressible fluids—Determination of flow rate characteristics**

**Equipment standards: JIS B 8373: Solenoid valve for pneumatics**

JIS B 8379: Silencer for pneumatics

JIS B 8381-1: Fittings for pneumatics—Part 1: Push-in fittings for thermoplastic resin tubing

JIS B 8381-2: Fittings for pneumatics—Part 2: Compression fittings for thermoplastic resin tubing

(2) Definition of flow rate characteristics

Effective area **S**: The cross-sectional area having an ideal throttle without friction deduced from the calculation of the pressure changes inside an air tank or without reduced flow when discharging the compressed air in a choked flow, from an equipment attached to the air tank. This is the same concept representing the “easy to run through” as sonic conductance **C**.

(3) Formula for flow rate

When

$$\frac{P_2 + 0.1}{P_1 + 0.1} \leq 0.5, \text{ choked flow}$$

$$Q = 120 \times S (P_1 + 0.1) \sqrt{\frac{293}{273 + T}} \dots\dots\dots(3)$$

When

$$\frac{P_2 + 0.1}{P_1 + 0.1} > 0.5, \text{ subsonic flow}$$

$$Q = 240 \times S \sqrt{(P_2 + 0.1) (P_1 - P_2)} \sqrt{\frac{293}{273 + T}} \dots\dots\dots(4)$$

Conversion with sonic conductance **C**:

$$S = 5.0 \times C \dots\dots\dots(5)$$

**Q** : Air flow rate[L/min(ANR)]

**S** : Effective area [mm<sup>2</sup>]

**P<sub>1</sub>** : Upstream pressure [MPa]

**P<sub>2</sub>** : Downstream pressure [MPa]

**T** : Temperature [°C]

Note) Formula for subsonic flow (4) is only applicable when the critical pressure ratio **b** is the unknown equipment. In the formula (2) by the sonic conductance **C**, it is the same formula as when **b** = 0.5.

(4) Test method

Attach a test equipment with the test circuit shown in Fig. (2) in order to discharge air into the atmosphere until the pressure inside the air tank goes down to 0.25 MPa (0.2 MPa) from an air tank filled with the compressed air at a certain pressure level (0.5 MPa) which does not go below 0.6 MPa. At this time, measure the discharging time and the residual pressure inside the air tank which had been left until it turned to be the normal values to determine the effective area **S**, using the following formula. The volume of an air tank should be selected within the specified range by corresponding to the effective area of an equipment for test. In the case of JIS B 8379, the pressure values are in parentheses and the coefficient of the formula is 12.9.

$$S = 12.1 \frac{V}{t} \log_{10} \left( \frac{P_s + 0.1}{P + 0.1} \right) \sqrt{\frac{293}{T}} \dots\dots\dots(6)$$

**S** : Effective area [mm<sup>2</sup>]

**V** : Air tank capacity [L]

**t** : Discharging time [s]

**P<sub>s</sub>**: Pressure inside air tank

before discharging [MPa]

**P** : Residual pressure inside air tank

after discharging [MPa]

**T** : Temperature inside air tank

before discharging [K]

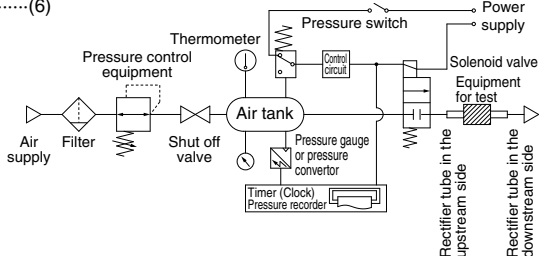

**Fig. (2) Test circuit based on JIS B 8390: 2000**

VX2
VXK
VXD
VXZ
<b>VXS</b>
VXB
VXE
VXP
VXR
VXH
VXF
VX3
VXA

### 2.3 Flow coefficient $C_v$ factor

The United States Standard ANSI/(NFPA)T3.21.3: R1-2008R: Pneumatic fluid power—Flow rating test procedure and reporting method for fixed orifice components

This standard defines the  $C_v$  factor of the flow coefficient by the following formula that is based on the test conducted by the test circuit analogous to ISO 6358.

$$C_v = \frac{Q}{114.5 \sqrt{\frac{\Delta P (P_2 + P_a)}{T_1}}} \dots\dots\dots(7)$$

$\Delta P$  : Pressure drop between the static pressure tapping ports [bar]

$P_1$  : Pressure of the upstream tapping port [bar gauge]

$P_2$  : Pressure of the downstream tapping port [bar gauge]:  $P_2 = P_1 - \Delta P$

$Q$  : Flow rate [L/s standard condition]

$P_a$  : Atmospheric pressure [bar absolute]

$T_1$  : Upstream absolute temperature [K]

Test conditions are  $< P_1 + P_a = 6.5 \pm 0.2$  bar absolute,  $T_1 = 297 \pm 5K$ ,  $0.07 \text{ bar} \leq \Delta P \leq 0.14$  bar.

This is the same concept as effective area  $A$  which ISO 6358 stipulates as being applicable only when the pressure drop is smaller than the upstream pressure and the compression of air does not become a problem.

### 3. Process fluid control equipment

(1) Conformed standard

**IEC60534-1: 2005: Industrial-process control valves. Part 1: control valve terminology and general considerations**

**IEC60534-2-3: 1997: Industrial-process control valves. Part 2: Flow capacity, Section Three- Test procedures**

**JIS B 2005-1: 2012: Industrial-process control valves – Part 1: Control valve terminology and general considerations**

**JIS B 2005-2-3: 2004: Industrial-process control valves – Part 2: Flow capacity – Section 3: Test procedures**

**Equipment standards: JIS B 8471: Solenoid valve for water**

**JIS B 8472: Solenoid valve for steam**

**JIS B 8473: Solenoid valve for fuel oil**

(2) Definition of flow rate characteristics

**$K_v$  factor:** Value of the clean water flow rate represented by  $m^3/h$  that runs through the valve (equipment for test) at 5 to 40°C, when the pressure difference is  $1 \times 10^5$  Pa (1 bar). It is calculated using the following formula:

$$K_v = Q \sqrt{\frac{1 \times 10^5}{\Delta P} \cdot \frac{\rho}{1000}} \dots\dots\dots(8)$$

$K_v$  : Flow coefficient [ $m^3/h$ ]

$Q$  : Flow rate [ $m^3/h$ ]

$\Delta P$  : Pressure difference [Pa]

$\rho$  : Density of fluid [ $kg/m^3$ ]

(3) Formula of flow rate

It is described by the practical units. Also, the flow rate characteristics are shown in Graph (2).

In the case of liquid:

$$Q = 53 K_v \sqrt{\frac{\Delta P}{G}} \dots\dots\dots(9)$$

$Q$  : Flow rate [L/min]

$K_v$  : Flow coefficient [ $m^3/h$ ]

$\Delta P$  : Pressure difference [MPa]

$G$  : Relative density [water = 1]

In the case of saturated aqueous vapor:

$$Q = 232 K_v \sqrt{\Delta P (P_2 + 0.1)} \dots\dots\dots(10)$$

$Q$  : Flow rate [kg/h]

$K_v$  : Flow coefficient [ $m^3/h$ ]

$\Delta P$  : Pressure difference [MPa]

$P_1$  : Upstream pressure [MPa]:  $\Delta P = P_1 - P_2$

$P_2$  : Downstream pressure [MPa]



Conversion of flow coefficient:

$$Kv = 0.865 Cv \dots\dots\dots(11)$$

Here,

**Cv** factor: Value of the clean water flow rate represented by US gal/min that runs through the valve at 40 to 100°F, when the pressure difference is 1 lbf/in<sup>2</sup> (psi)

Value is different from **Kv** and **Cv** factors for pneumatic purpose due to different test method.

(4) Test method

Connect the equipment for the test to the test circuit shown in Fig. (3), and run water at 5 to 40°C. Then, measure the flow rate with a pressure difference where vaporization does not occur in a turbulent flow (pressure difference of 0.035 MPa to 0.075 MPa when the inlet pressure is within 0.15 MPa to 0.6 MPa). However, as the turbulent flow is definitely caused, the pressure difference needs to be set with a large enough difference so that the Reynolds number does not fall below 1 x 10<sup>5</sup>, and the inlet pressure needs to be set slightly higher to prevent vaporization of the liquid. Substitute the measurement results in formula (8) to calculate **Kv**.

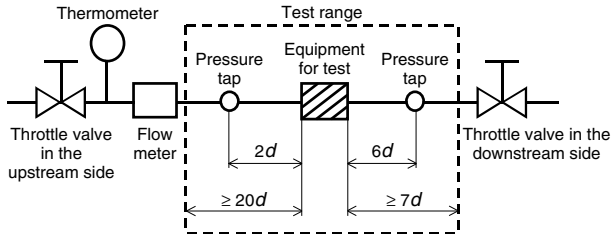
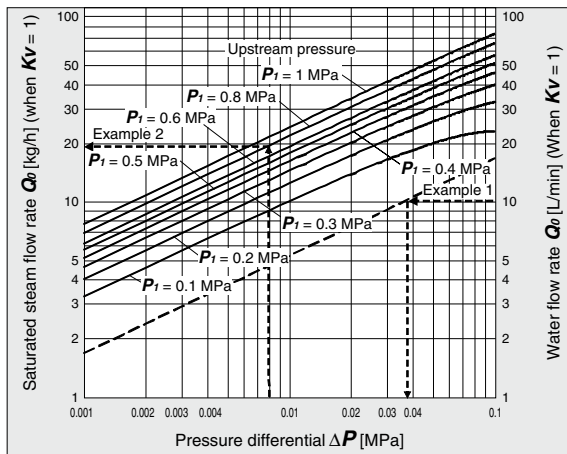

Fig. (3) Test circuit based on IEC60534-2-3, JIS B 2005-2-3



Graph (2) Flow rate characteristics

Example 1)

Obtain the pressure difference when water [15 L/min] runs through the solenoid valve with a **Kv** = 1.5 m<sup>3</sup>/h. As the flow rate when **Kv** = 1 is calculated as the formula:  $Q_0 = 15 \times 1/1.5 = 10$  [L/min], read off  $\Delta P$  when  $Q_0$  is 10 [L/min] in Graph (2). The reading is 0.036 [MPa].

Example 2)

Obtain the saturated steam flow rate when  $P_i = 0.8$  [MPa] and  $\Delta P = 0.008$  [MPa] with a solenoid valve with a **Kv** = 0.05 [m<sup>3</sup>/h]. Read off  $Q_0$  when  $P_i$  is 0.8 and  $\Delta P$  is 0.008 in Graph (2), the reading is 20 kg/h. Therefore, the flow rate is calculated as the formula:  $Q = 0.05/1 \times 20 = 1$  [kg/h].

- VX2
- VXK
- VXD
- VXZ
- VXS**
- VXB
- VXE
- VXP
- VXR
- VXH
- VXF
- VX3
- VXA

# VXS Series

# Flow Rate Characteristics

Note) Use this graph as a guide. In the case of obtaining an accurate flow rate, refer to pages 227 and 228.

## For Saturated Steam

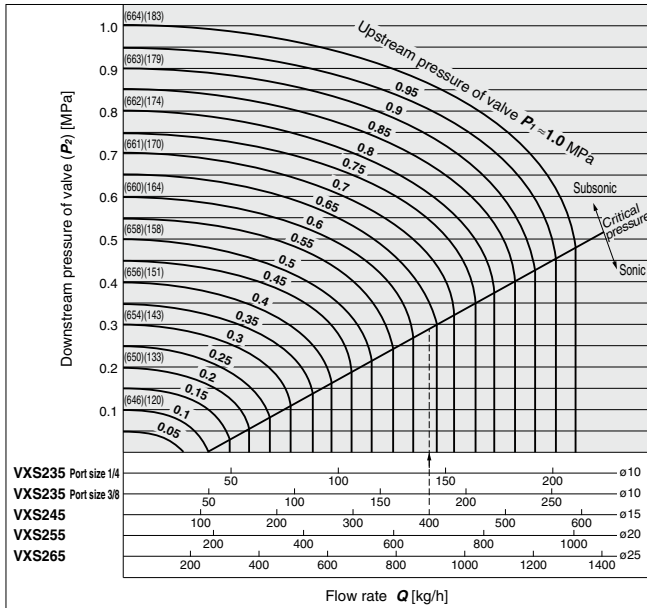

( ) : Saturated steam holding heat (kcal/kg) ( ) : Saturation temperature ( $^{\circ}$ C)

## For Water

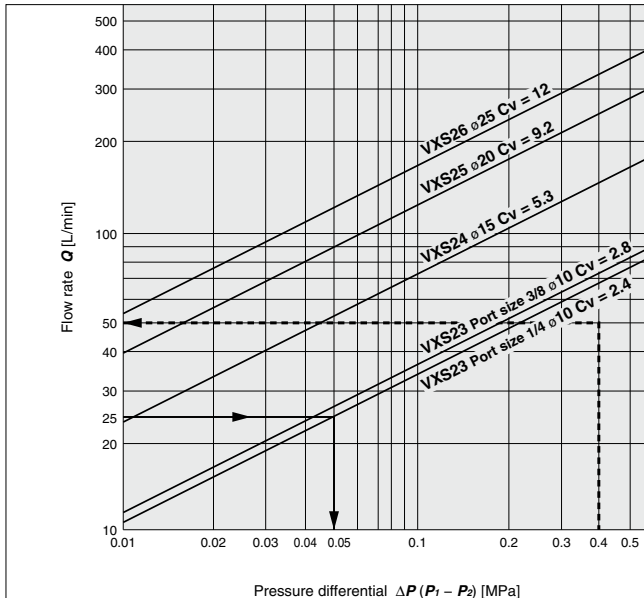

## How to read the graph

The pressure differential to generate a flow rate of 25 L/min water is as follows.

For a  $\phi 10$  orifice (VXS23/Port size 1/4),  $\Delta P = 0.05$  MPa

The optimum size for a pressure differential of  $\Delta P = 0.2$  MPa and a flow of 50 L/min will be the VXS23 ( $\phi 10$  orifice, port size 3/8).



# VXS Series

## Specific Product Precautions 1

Be sure to read this before handling the products.

Refer to back page 50 for Safety Instructions and pages 17 to 19 for 2 Port Solenoid Valve for Fluid Control Precautions.

### Design

#### Warning

##### 1. Cannot be used as an emergency shutoff valve etc.

The valves presented in this catalog are not designed for safety applications such as an emergency shutoff valve. If the valves are used in this type of system, other reliable safety assurance measures should also be adopted.

##### 2. Extended periods of continuous energization

The solenoid coil will generate heat when continuously energized. Avoid using in a tightly shut container. Install it in a well ventilated area. Furthermore, do not touch it while it is being energized or right after it is energized.

##### 3. Closed liquid circuit

In a closed circuit, when liquid is static, pressure could rise due to changes in temperature. This pressure rise could cause malfunction and damage to components such as valves. To prevent this, install a relief valve in the system.

##### 4. Pressure holding

It is not usable for an application such as holding the pressure inside of a pressure vessel because air leakage is entailed in a valve.

##### 5. When the conduit type is used as equivalent to an IP65 enclosure, install a wiring conduit etc.

##### 6. When an impact, such as steam hammer etc., caused by the rapid pressure fluctuation is applied, the solenoid valve may be damaged. Give an attention to it.

### Selection

#### Warning

##### 1. Usage with low flow

Unstable flow may occur with the product under the following conditions: • low flow from the pump or boiler, etc. • use of several elbows or tees in the circuit, or • thin nozzles installed at the end of the piping etc. This can cause valve opening/closing failure, or oscillation, and cause a valve malfunction.

Check the pressure differential and flow to select the appropriate size of the valve referring to the Flow rate Characteristics on page 232. Ensure that pressure differential does not become lower than 0.01 MPa during ON (N.C.: Valve open).

##### 2. Fluid

###### 1) Corrosive gas

Cannot be used since it will lead to cracks by stress corrosion or result in other incidents.

2) When a brass body is used, then depending on water quality, corrosion and internal leakage may occur. If such abnormalities occur, exchange the product for a stainless steel body.

3) Use an oil-free specification when any oily particle must not enter the passage.

### Selection

#### Warning

##### 3. Air quality

###### <Steam, Water>

The use of a fluid that contains foreign objects can cause problems such as malfunction and seal failure by promoting wear of the valve seat and armature, and by sticking to the sliding parts of the armature etc. Install a suitable filter (strainer) immediately upstream from the valve. As a general rule, use 100 mesh.

As a standard, the mesh count for the strainer is 100 mesh. However, the size and shape of foreign objects that occur depends on the operating environment. Check the fluid status and choose an appropriate mesh count.

The supply water to a boiler includes materials that create a hard sediment or sludge such as calcium and magnesium.

Sediment and sludge from steam can cause the valve to not operate properly. Install a water softening device, which removes these materials. Do not use operation steam which contains chemicals, synthetic oils containing organic solvents, salts or corrosive gases, etc., as these can cause damage or deterioration.

The seal material (special FKM) used for wetted parts of the product can withstand steam in standard conditions. However, the resistance of the sealing material can deteriorate depending on the types of additives such as boiler compounds and water conditioners within the boiler steam. Please only utilize the product after determining the sealing material resistance within the actual usage conditions.

##### 4. Ambient environment

Use within the operable ambient temperature range. Check the compatibility between the product's composition materials and the ambient atmosphere. Be certain that the fluid used does not touch the external surface of the product.

##### 5. Low temperature operation

1) The valve can be used in an ambient temperature of between -20 to -10°C. However, take measures to prevent freezing or solidification of impurities, etc.

2) When using valves for water application in cold climates, take appropriate countermeasures to prevent the water from freezing in tubing after cutting the water supply from the pump, by draining the water etc. When warming by a heater etc., be careful not to expose the coil portion to a heater.

Installation of a dryer, heat retaining of the body is recommended to prevent a freezing condition in which the dew point temperature is high and the ambient temperature is low, and the high flow runs.

VX2

VXK

VXD

VXZ

VXS

VXB

VXE

VXP

VXR

VXH

VXF

VX3

VXA



# VXS Series Specific Product Precautions 2

Be sure to read this before handling the products.

Refer to back page 50 for Safety Instructions and pages 17 to 19 for 2 Port Solenoid Valve for Fluid Control Precautions.

## Selection

### ⚠ Caution

#### 1. Leakage voltage

When the solenoid valve is operated using the controller, etc., the leakage voltage should be the product allowable leakage voltage or less. Particularly when using a resistor in parallel with a switching element and using a C-R element (surge voltage suppressor) to protect the switching element, take note that leakage current will flow through the resistor, C-R element, etc., creating a possible danger that the valve may not turn off.

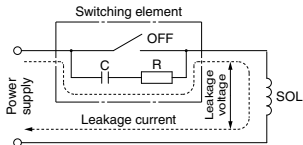

AC coil: 5% or less of rated voltage  
DC coil: 2% or less of rated voltage

## Mounting

### ⚠ Warning

#### 1. If air leakage increases or equipment does not operate properly, stop operation.

After mounting is completed, confirm that it has been done correctly by performing a suitable function test.

#### 2. Do not apply external force to the coil section.

When tightening is performed, apply a wrench or other tool to the outside of the piping connection parts.

#### 3. Mount a valve with its coil position upward, not downward.

When mounting a valve with its coil positioned downward, foreign objects in the fluid will adhere to the iron core leading to a malfunction. Especially for strict leakage control, the coil must be positioned upward.

#### 4. Do not warm the coil assembly with a heat insulator etc.

Use tape, heaters, etc., for freeze prevention on the piping and body only. They can cause the coil to burn out.

#### 5. Secure with brackets, except in the case of steel piping and copper fittings.

#### 6. Avoid sources of vibration, or adjust the arm from the body to the minimum length so that resonance will not occur.

#### 7. Painting and coating

Warnings or specifications printed or labeled on the product should not be erased, removed or covered up.

## Piping

### ⚠ Caution

#### 1. Preparation before piping

Before piping is connected, it should be thoroughly blown out with air (flushing) or washed to remove chips, cutting oil and other debris from inside the pipe. Avoid pulling, compressing, or bending the valve body when piping.

#### 2. Avoid connecting ground lines to piping, as this may cause electric corrosion of the system.

#### 3. Always tighten threads with the proper tightening torque.

Refer to the tightening torque in the table below for connecting steel piping. Lower tightening torque will lead into fluid leakage. For mounting the fittings, refer to the specified torque.

#### Tightening Torque for Piping

Connection thread	Proper tightening torque (N·m)
Rc1/8	7 to 9
Rc1/4	12 to 14
Rc3/8	22 to 24
Rc1/2	28 to 30
Rc3/4	36 to 38
Rc1	36 to 38

#### 4. Connection of piping to products

When connecting piping to a product, avoid mistakes regarding the supply port etc.

#### 5. Winding of sealant tape

When connecting pipes, fittings, etc., be sure that chips from the pipe threads and sealing material do not enter the valve.

Furthermore, when sealant tape is used, leave 1.5 to 2 thread ridges exposed at the end of the threads.

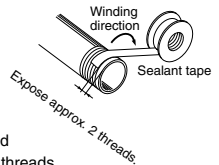

#### 6. If an excessive amount of thread sealant such as sealant tape or liquid thread sealant is used during piping, it will get inside the product and lead to malfunction.

#### 7. Steam generated in a boiler contains a large amount of drainage. Be sure to operate it with a drain trap installed.

#### 8. Arrange piping so that condensate will not accumulate in the solenoid valve.

Install the piping to the solenoid valve higher than peripheral piping. Be sure to avoid installing the piping to the solenoid valve at the lowest part of the piping layout. If condensate accumulates in the solenoid valve or peripheral piping, the steam entering the piping will cause steam hammer. This will lead to destruction and malfunction of the solenoid valve and piping. If steam hammer causes problems, install bypass piping to thoroughly discharge condensate from the piping. Apply steam to the device afterward to start operation.



## VXS Series

# Specific Product Precautions 3

Be sure to read this before handling the products.

Refer to back page 50 for Safety Instructions and pages 17 to 19 for 2 Port Solenoid Valve for Fluid Control Precautions.

### Piping

#### ⚠ Caution

- If the effective area of piping on the fluid supply side is restricted, the operating time may become unstable due to differential pressure fluctuation when the valve is closed.
- For the convenience of maintenance and repair, install a bypass circuit and use a union for piping.
- To control the fluid in the tank, connect the piping a little higher than the bottom of the tank.

### Wiring

#### ⚠ Warning

- The solenoid valve is an electrical product. For safety, install an appropriate fuse and circuit breaker before use.  
When using multiple solenoid valves, it is not sufficient to merely install one fuse on the inlet side. In order to ensure the safety of the devices, select and install a fuse for each circuit.
- Do not apply AC voltage to AC type unless it is built in full-wave rectifier, or the coil will be damaged.

#### ⚠ Caution

- As a rule, use electrical wire with a cross sectional area of 0.5 to 1.25 mm<sup>2</sup> for wiring.  
Furthermore, do not allow excessive force to be applied to the lines.
- Use electrical circuits which do not generate chattering in their contacts.
- Use voltage which is within  $\pm 10\%$  of the rated voltage. In cases with a DC power supply where importance is placed on responsiveness, stay within  $\pm 5\%$  of the rated value. The voltage drop is the value in the lead wire section connecting the coil.
- When a surge from the solenoid affects the electrical circuitry, install a surge voltage suppressor etc., in parallel with the solenoid. Or, adopt an option that comes with the surge voltage protection circuit. (However, a surge voltage occurs even if the surge voltage protection circuit is used. For details, please consult with SMC.)

### Operating Environment

#### ⚠ Warning

- Do not use in an atmosphere having corrosive gases, chemicals, sea water, water, water vapor, or where there is direct contact with any of these.
- Do not use in explosive atmospheres.
- Do not use in locations subject to vibration or impact.
- Do not use in locations where radiated heat will be received from nearby heat sources.
- Employ suitable protective measures in locations where there is contact with water droplets, oil or welding spatter, etc.

### Maintenance

#### ⚠ Warning

##### 1. Removing the product

The valve will reach a high temperature when used with high temperature fluids. Confirm that the valve temperature has dropped sufficiently before performing work. If touched inadvertently, there is a danger of being burned.

- Shut off the fluid supply and release the fluid pressure in the system.
- Shut off the power supply.
- Dismount the product.

##### 2. Low frequency operation

Switch valves at least once every 30 days to prevent a malfunction. Also, in order to use it under the optimum state, conduct a regular inspection once a half year.

#### ⚠ Caution

##### 1. Strainers

- Be careful regarding clogging of strainers.
- Clean strainers when the pressure drop reaches 0.1 MPa.

##### 2. Lubrication

When using after lubricating, never forget to lubricate continuously.

##### 3. Storage

In case of long term storage after use, thoroughly remove all moisture to prevent rust and deterioration of rubber materials etc.

##### 4. Exhaust the drainage from the piping periodically.

### Operating Precautions

#### ⚠ Warning

- The valve will reach a high temperature when used with high temperature fluids. Use caution, as there is a danger of being burned if a valve is touched directly.
- The valve may become hot if energized continuously. Use caution, as there is a danger of being burned if a valve is touched directly.
- If there is a possibility of reverse pressure being applied to the valve, take countermeasures such as mounting a check valve on the downstream side of the valve.
- When problems are caused by a steam hammer, install a steam hammer relief device such as an accumulator.
- When the pilot type 2 port solenoid valve is closed, and pressure is applied suddenly due to the starting of fluid supply source such as a boiler, the valve may open momentarily and fluid may leak.
- If the product is used in the conditions in which rapid decrease in the inlet pressure of the valve and rapid increase in the outlet pressure of the valve are repeated, excessive stress will be applied to the piston, which causes the piston to be damaged and dropped, leading to the operation failure of the valve. Check the operating conditions before use.

VX2

VXK

VXD

VXZ

VXS

VXB

VXE

VXP

VXR

VXH

VXF

VX3

VXA



# VXS Series

## Specific Product Precautions 4

Be sure to read this before handling the products.

Refer to back page 50 for Safety Instructions and pages 17 to 19 for 2 Port Solenoid Valve for Fluid Control Precautions.

### Electrical Connections

#### ⚠ Caution

##### ■ Grommet

Class H coil: AWG18 Insulator O.D. 2.1 mm

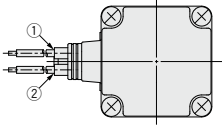

Rated voltage	Lead wire color	
	①	②
DC	Black	Red
100 VAC	Blue	Blue
200 VAC	Red	Red
Other AC	Gray	Gray

\* There is no polarity.

##### ■ DIN terminal

##### Disassembly

- After loosening the binding head screw with flange, then if the housing is pulled in the direction of the arrow, the connector will be removed from the solenoid valve.
- Pull out the binding head screw with flange from the housing.
- There is a cutout on the bottom of the terminal block. Insert a small flat head screwdriver, etc. into this cutout, and remove the terminal block from the housing. (See figure below.)
- Remove the ground nut, and pull out the washer and the rubber seal.

##### Wiring

- Pass the cable through the ground nut, washer and rubber seal in this order, and insert these parts into the housing.
- Loosen the binding head screw of the terminal block, then insert the core wire or the crimped terminal of the lead wire into the terminal, and securely fix it with the binding head screw. The binding head screw of the terminal block is M3.  
Note 1) Tighten the screw to a torque of between 0.5 and 0.6 N·m.  
Note 2) Cable O.D.:  $\phi 6$  to  $\phi 12$  mm  
Note 3) For an outside cable diameter of  $\phi 9$  to 12 mm, remove the internal parts of the rubber seal before using.

##### Assembly

- Pass the cable through the ground nut, washer, rubber seal and the housing in this order, and connect to the terminal block. Then, set the terminal block inside the housing. (Push in the terminal block until it snaps into position.)
- Insert the rubber seal and the washer in this order into the cable entry of the housing, and then tighten the ground nut securely.
- Insert the gasket between the bottom part of the terminal block and the plug attached to the equipment, and then insert the binding head screw with flange from the top of the housing, and tighten it.  
Note 1) Tighten the screw to a torque of between 0.5 and 0.6 N·m.  
Note 2) The orientation of the connector can be changed in steps of 90° by changing the method of assembling the housing and the terminal block.

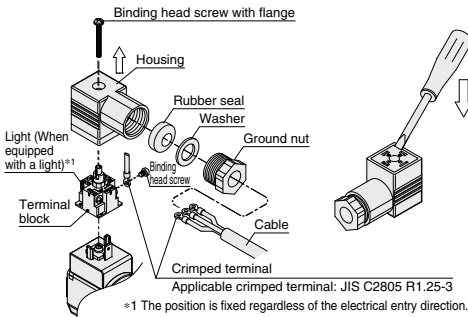

#### ⚠ Caution

Internal connections are as shown below. Make connections to the power supply accordingly.

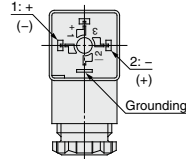

Terminal no.	1	2
DIN terminal	+ (-)	- (+)

\* There is no polarity.

##### DIN (EN175301-803) Terminal

This DIN terminal corresponds to the Form A DIN connector with an 18 mm terminal pitch, which complies with EN175301-803B.

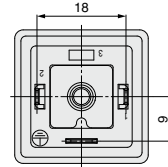

##### ■ Conduit terminal

##### Disassembly

- Loosen the mounting screw, and remove the terminal cover from the conduit terminal.

##### Wiring

- Insert the cable into the conduit terminal.
- Loosen the screw with UP terminal of the conduit terminal, then insert the core wire or the crimped terminal of the lead wire into the terminal, and securely fix it with the screw with UP terminal.  
Note 1) Tighten the screw to a torque of between 0.5 and 0.6 N·m.



# VXS Series

## Specific Product Precautions 5

Be sure to read this before handling the products.

Refer to back page 50 for Safety Instructions and pages 17 to 19 for 2 Port Solenoid Valve for Fluid Control Precautions.

### Electrical Connections

#### ⚠ Caution

##### Assembly

1. Insert the gasket into the conduit terminal, and then clamp the terminal cover with the mounting screw.  
Note 1) Tighten the screw to a torque of between 0.5 and 0.6 N·m.  
Note 2) When changing the orientation of the conduit terminal, carry out the following procedure.
    1. Apply a tool (monkey wrench, spanner, etc.) to the width across flats of the conduit terminal, and turn the terminal in the counterclockwise direction.
    2. Loosen the lock nut.
    3. Turn the conduit terminal in the clamping direction (clockwise direction) to about 15° ahead of the desired position.
    4. Turn the lock nut by hand to the coil side until it is lightly tightened.
    5. Apply a tool to the width across flats of the conduit terminal, and turn it to the desired position (through an angle of about 15°) so as to clamp the conduit terminal.
- Note) When changing the orientation by applying additional tightening force to the conduit terminal from the factory-set position, turn no more than one half a turn.

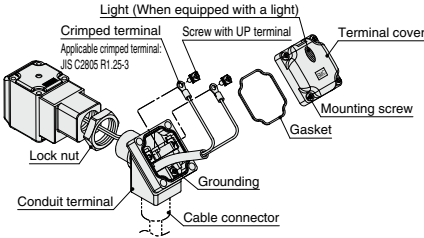

Make connections according to the marks shown below.

- Use the tightening torques below for each section.
- Properly seal the terminal connection (G1/2) with the special wiring conduit etc.

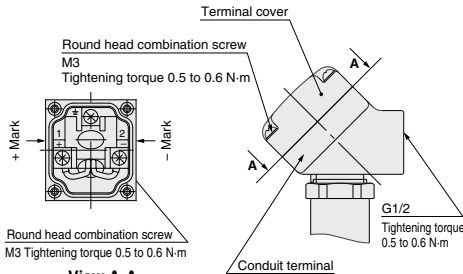

#### View A-A

(Internal connection diagram)

#### ■ Conduit

When used as an IP65 equivalent, use seal to install the wiring conduit. Also, use the tightening torque below for the conduit.

Class H coil: AWG18 Insulator O.D. 2.1 mm

### Electrical Connections

#### ⚠ Caution

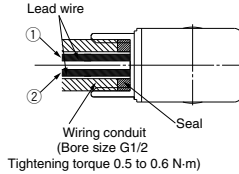

Rated voltage	Lead wire color	
	①	②
DC	Black	Red
100 VAC	Blue	Blue
200 VAC	Red	Red
Other AC	Gray	Gray

\* There is no polarity.

Description	Part no.
Seal	VCW20-15-6

Note) Please order separately.

### Electrical Circuits

#### ⚠ Caution

[DC circuit]

Grommet

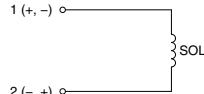

Without electrical option

DIN terminal

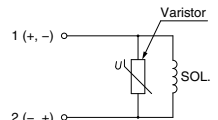

With surge voltage suppressor

DIN terminal, Conduit terminal

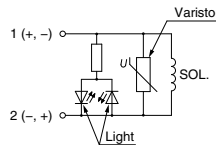

With light/surge voltage suppressor

[AC circuit]

Grommet, DIN terminal, Conduit terminal, Conduit

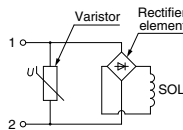

With surge voltage suppressor

DIN terminal, Conduit terminal

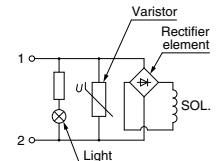

With light/surge voltage suppressor

DIN terminal H type with AC voltage has full-wave rectifier built in the DIN connector. Coil does not have full-wave rectifier.

VX2

VXK

VXD

VXZ

VXS

VXB

VXE

VXP

VXR

VXH

VXF

VX3

VXA