

# Compact Manometer

## PPA Series

Pressure measurements can easily be taken any time, anywhere.



### Compact and lightweight

Portable type with a lightweight of only about 100 g (unit 50 g, battery 50 g) can also be held in the palm of the hand.

### Back light for easy viewing in dark locations

### Long service life of 12 months continuous operation

One year of continuous operation is possible with 2 type AA batteries (3 V).

### Convenient hand strap for carrying

Keeping practical use in mind, the hand strap is a standard feature.

### Zero/span calibration is possible

Offset adjustment with the zero clear function, and span calibration with the trimmer can be performed.

### Peak/Bottom hold function

With pressure being displayed, variations in supply pressure can be grasped instantly with one touch switching of the display from peak value to bottom value.

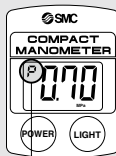

Peak display



Bottom display

### Auto power off function to save batteries

Power turns off automatically if not operated for more than 5 minutes.

### Case holder is available

The case holder is provided as an option to allow for situations where portability is not required.

G

GS

PPA

# Pressure measurements can easily be taken any time, anywhere.

## Application Example

### Confirmation of air line source pressure

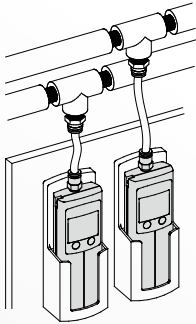

Human reading error is eliminated by the ability to confirm line pressure on the digital display. It is also possible to check pulsation in the source pressure using the peak/bottom display function.

### Confirmation of regulator set pressure

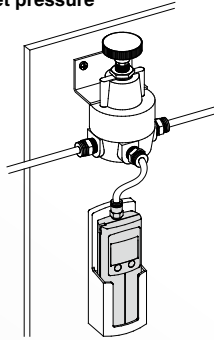

Setting a regulator can be performed more precisely than with a dial gauge by viewing the digital display while making the setting. Furthermore, power lines are not needed for this battery operated unit.



Compact Manometer

# PPA Series

## Related products for line pressure measurement

Convenient for easy line pressure measurement without removing piping or stopping supply pressure, etc.

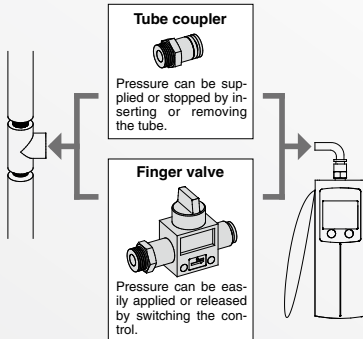

For specifications, refer to page 903.

## Can also be used as an energy saving related device

- Measures the total pressure received by an air blown workpiece



# Compact Manometer

# PPA Series

## PPA100/101/102



### How to Order

PPA10 0 — [ ] — [ ] — M

#### Pressure specifications

0	-0.1 to 1 MPa (For high pressure)
1	-101 to 10 kPa (For vacuum)
2	-10 to 100 kPa (For low pressure)

#### Unit specifications

Nil	With the unit switching function
M	Fixed in SI unit (Note)

Note) Fixed unit  
For vacuum/compound pressure: kPa  
For positive pressure: MPa

#### Option/Case holder

Nil	None
B	With PPA-B

#### One-touch fitting type

Symbol	Applicable tubing size	One-touch fitting	Applicable tubing material
Nil	None	None	None
04	ø4 (mm size)	KQ2H04-M5N	Nylon Soft nylon Polyurethane
06	ø6 (mm size)	KQ2H06-M5N	

For details about the Pressure Switch Precautions and Specific Product Precautions, refer to the Best Pneumatics No.8.

### Specifications

Model	PPA100 for high press.	PPA101 for vacuum	PPA102 for low press.
Rated pressure range	-0.1 to 1 MPa	-101 to 10 kPa	-10 to 100 kPa
Display method	3 digit LCD back light		
Pressure display discrimination	1/100		
Min. display units <sup>(1)</sup>	kPa	—	1
	MPa	0.01	—
	mmHg	—	5
	kgf/cm <sup>2</sup>	0.1	0.01
	inHg	—	0.2
	psi	1	0.1
	bar	0.1	0.01
Error display	Over pressure, Memory data error, Change battery sign		
Function	Peak/bottom display, Backlight, Auto power OFF Zero clear, Units display switching		
Withstanding pressure	1.5 MPa	200 kPa	200 kPa
Applicable fluid	Air, Non-corrosive gases, Nonflammable gas		
Power supply voltage	3 VDC, Type AA dry cell x 2 pcs.		
Battery life	12 months continuous operation (Without backlighting, temperature conditions: at 25°C)		
Response speed	250 ms		
Display accuracy	±2% F.S. or less (Temperature conditions: at 25°C) <sup>(2)</sup>		
Repeatability	±1% F.S. or less (Temperature conditions: at 25°C)		
Temperature characteristics	±3% F.S. or less (0 to 50°C with 25°C standard)		
Connection port size	M5 x 0.8		
Operating temperature range	0 to 50°C (With no condensation)		
Operating humidity range	35 to 85% RH (With no condensation)		
Enclosure	IP40		
Weight	Approx. 100 g (Unit 50 g, batteries 50 g)		
Standard	CE/RoHS		

\* 2 pcs. of type AA dry batteries (manganese R6 or alkaline LR6) are not included.

Note 1) For the unit switching function (Types without the unit switching function is fixed in SI unit (kPa or MPa).)

Note 2) In regards to the compatibility condition of the EMC directives, the pressure display value variation is ±15% F.S. or less.

## Description of Operating Parts

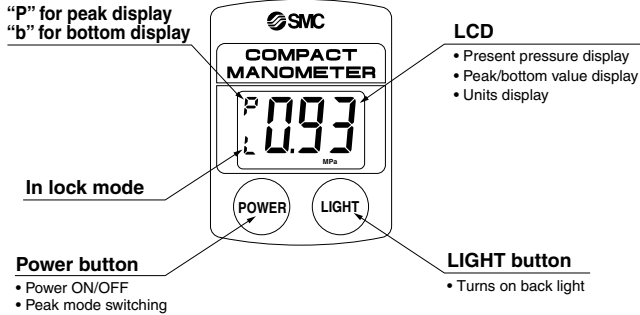

## Operation and Functions

(PPA100 shown, Unit: MPa)

### Initial Setting

Be certain to perform initial setting when using for the first time and after changing batteries, as the unit will indicate memory data error.



### Power ON

Press the **POWER** button.



- The power comes ON as it is pressed.
- When pressed and held for 6 seconds or more, the unit goes into zero clear.

### Power OFF

Press and hold the **POWER** button for 3 seconds or more.

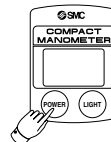

- When pressed and held for 3 seconds or more, the power turns OFF.
- When there is no button operation for more than 5 minutes, the power turns OFF. (auto power OFF function)

## Operation and Functions

(PPA100 shown, Unit: MPa)

### Unit Display Switching

Note) This operation cannot be done for the type which does not have the unit switching function.

1. Press and hold the **POWER** and **LIGHT** buttons for 3 seconds or more.
1. When pressed continuously for 3 seconds or more, the unit on the LCD will flash.
2. The unit will change. (See the table below.)
3. The unit is set, and switching is finished.

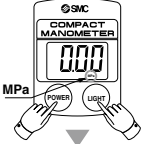

High pressure (PPA100)	Vacuum (PPA101)	Low pressure (PPA102)
MPa → bar	kPa → bar → psi	kPa → bar
→ psi → kgf	→ inHg → mmHg	→ psi → kgf

Note) The "inHg" unit cannot be displayed.

### Auto Power OFF Function

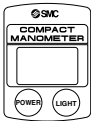

When the power is turned ON and there is no button operation for more than 5 minutes, the power will turn OFF. Note) For cancelling this function, refer to the functions and operation of the lock mode (below).

### Lock Mode (Auto power OFF cancel)

Press and hold the **POWER** and **LIGHT** buttons for 6 seconds or more.

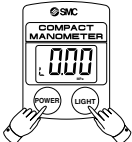

The auto power OFF function is canceled by activating the lock mode (auto power OFF cancel). When continuously pressed for 6 seconds or more, "L" is displayed on the LCD. Moreover, when the power is turned OFF, the lock mode is released.

### Peak/Bottom Display

Note) Since this is combined with power OFF operation, the button should be released at the point when "P" or "b" is displayed.

Press the **POWER** button. Do this when pressure is being displayed.



Press the **POWER** button. Do this when pressure is being displayed.



Press the **POWER** button. Do this when pressure is being displayed.



### Turning on the Backlight

Press the **LIGHT** button. It normally lights up while the button is being pressed. In the lock mode, it lights up when pressed and turns off when pressed again. However, the maximum lighting time is approximately one minute.



### Zero Clear

Press the **POWER** button for 6 seconds or more. The zero point displayed at atmospheric pressure can be automatically adjusted. By this means it is possible to eliminate a display discrepancy at atmospheric pressure.



- Turn the power OFF.
- Release the supply pressure to the atmosphere.
- When continuously pressed for 6 seconds or more, zero clear is performed and "CAL" is displayed on the LCD.

## Dimensions

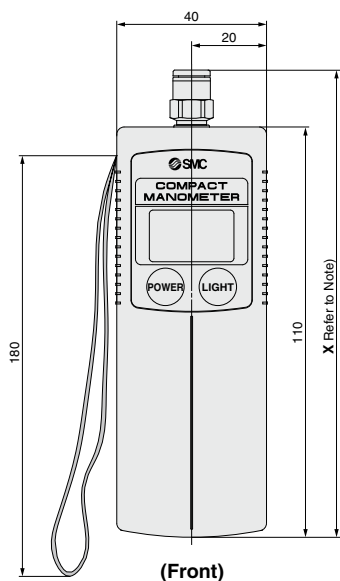

(Front)

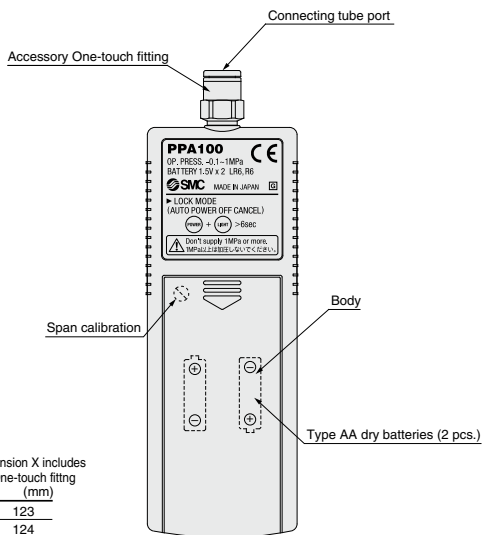

(Back)

Note) Dimension X includes the One-touch fitting (mm)

ø4	123
ø6	124

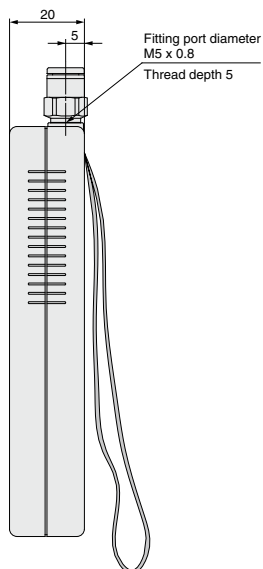

### Option/Case holder

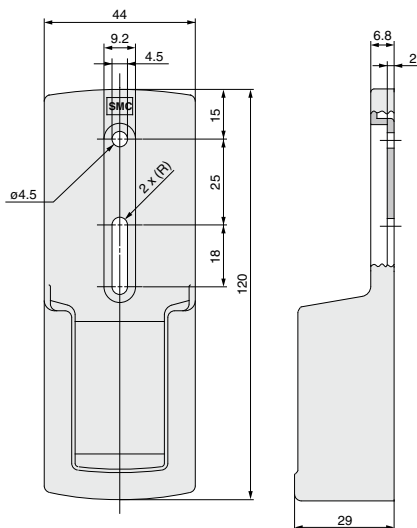

## Error Correction

When errors occur, they should be corrected as shown below.

Display	Contents	Corrective action
---	Pressure being applied is above the rating.	Operate within the rated pressure range.
Err	Memory data has probably been corrupted in some way.	Perform zero clear.
Entire display flashes	Battery voltage is low.	Replace the batteries.

## Maintenance

### Span calibration method

#### ⚠ Caution

**Do not touch the span calibration trimmer except when performing span calibration.**

1. Perform zero clear at atmospheric pressure.
2. Apply the maximum rated pressure, and calibrate the span while comparing with a standard pressure gauge.
3. If the display value of the compact manometer is "0" after returning to atmospheric pressure, then calibration is complete. If the display value is not "0", calibrate again by repeating steps 1 and 2.

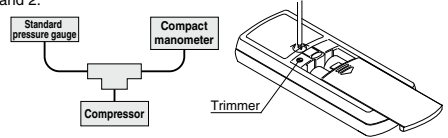

### Replacing the batteries

When battery voltage becomes low the entire LCD will flash.

When the LCD flashes replace the batteries. Use 2 pcs. of type AA dry batteries.

#### ⚠ Caution

**To replace the batteries, turn the power OFF and replace them within approximately 30 seconds.**

**When not completed within 30 seconds, "Err" will be displayed. In that case, perform zero clear once again.**

In the event that the display runs out of control, remove the batteries for one minute or longer, and then perform zero clear again for inserting the batteries and turning on the power.

## Related Products Useful for Measuring Line Pressure

These products are convenient for measuring line pressure easily without the need to remove piping or stop supply pressure, etc.

**Switching between pressurization and atmospheric release can be easily performed by switching the control.**

Finger valve

**VHK Series**



### Specifications

Valve type	2 port valve, 3 port valve
Fluid	Air
Proof pressure	1.5 MPa
Maximum operating pressure <sup>Note 1)</sup>	1.0 MPa
Operating vacuum pressure <sup>*</sup>	-100 kPa
Ambient and fluid temperature	0 to 60°C
Applicable tubing material <sup>Note 2)</sup>	Nylon, Soft nylon, Polyurethane
Option	Bracket

Note 1) Please note that when the valve is used at micro pressures of 0.1 MPa or less, valve leakage may be more than the standard value (5 cm<sup>3</sup>/min).  
 Note 2) Use caution with soft nylon and polyurethane at the maximum operating pressure. (For details, refer to pages 464 and 465.)

\* For a vacuum application, use VHK2 (2 way valve).

### Symbol

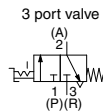
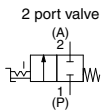

Refer to Best Pneumatics No. 1-2 for details.

**Pressure can be supplied or stopped by inserting or removing a tube.**

Self-seal fittings

**KC Series**



### Applicable Tubing

Tubing material	Nylon, Soft nylon, Polyurethane
Tubing O.D.	ø4, ø6, ø8, ø10, ø12

### Specifications

Fluid	Air	
Maximum operating pressure	1 MPa	
Proof pressure	3 MPa	
Ambient and fluid temperature	-5 to 60°C (No freezing)	
Thread	Mounting section	JIS B 0203 (Taper threads for piping) JIS B 0205 (Metric coarse thread)
	Nut section	JIS B 0205 (Metric fine thread)
Seal on the threads (Standard)	With sealant	
Copper-free (Standard)	Brass parts are all electroless nickel plated.	

### Principal Parts Material

Body	C3604, PBT
Stud	C3604 (Thread portion)
Chuck spring	Stainless steel 304
Guide	Stainless steel 304, PBT
Collet release bushing	POM
Valve retainer	POM
Stopper	C3604, POM
Seal O-ring	NBR
Gasket	Stainless steel 304, NBR

For details, refer to page 207.